

## ROLLER CHAIN SPROCKETS

PRODUCT	PAGE
INDEX .....	E-1 – E-2
MADE-TO-ORDER CAPABILITIES .....	E-3
<b>SECTION I – STANDARD SPROCKETS</b> .....	<b>E-4 – E-112</b>
Shear Pin Sprockets, Bolt-On .....	E-4 – E-6
Type D Sprockets, Detachable Hubs Split and Solid .....	E-7
Instant Split® Sprockets .....	E-8
Torque Limiter .....	E-9 – E-10
Double Pitch Sprockets .....	E-11 – E-15
Double Single Sprockets .....	(See Pitch Below)
Sprockets, Stock .....	E-16 – E-112
No. 25 — ¼" pitch .....	E-16 – E-17
No. 35 — ⅜" pitch .....	E-18 – E-26
No. 41 — ½" pitch .....	E-27 – E-29
No. 40 — ½" pitch .....	E-30 – E-42
No. 50 — ⅝" pitch .....	E-43 – E-55
No. 60 — ¾" pitch .....	E-56 – E-68
No. 80 — 1" pitch .....	E-69 – E-81
No. 100 — 1¼" pitch .....	E-82 – E-91
No. 120 — 1½" pitch .....	E-92 – E-97
No. 140 — 1¾" pitch .....	E-98 – E-102
No. 160 — 2" pitch .....	E-103 – E-107
No. 180 — 2¼" pitch .....	E-108
No. 200 — 2½" pitch .....	E-109 – E-111
No. 240 — 3" pitch .....	E-112
<b>SECTION II – METRIC SPROCKETS</b> .....	<b>E-113 – E-151</b>
ISO - 06B-1, Metric 35 - 0.375" (9.525 mm) Pitch, Simplex .....	E-114 – E-115
ISO - 06B-2, Metric 35-2 - 0.375" (9.525 mm) Pitch, Duplex .....	E-116 – E-117
ISO - 06B-3, Metric 35-3 - 0.375" (9.525 mm) Pitch, Triplex .....	E-118
ISO - 08B-1, Metric 40 - 0.500" (12.70 mm) Pitch, Simplex .....	E-119 – E-120
ISO - 08B-2, Metric 40-2 - 0.500" (12.70 mm) Pitch, Duplex .....	E-121 – E-122
ISO - 08B-3, Metric 40-3 - 0.500" (12.70 mm) Pitch, Triplex .....	E-123
ISO - 10B-1, Metric 50 - 0.625" (15.88 mm) Pitch, Simplex .....	E-124 – E-125
ISO - 10B-2, Metric 50-2 - 0.625" (15.88 mm) Pitch, Duplex .....	E-126 – E-127
ISO - 10B-3, Metric 50-3 - 0.625" (15.88 mm) Pitch, Triplex .....	E-128
ISO - 12B-1, Metric 60 - 0.750" (19.05 mm) Pitch, Simplex .....	E-129 – E-130
ISO - 12B-2, Metric 60-2 - 0.750" (19.05 mm) Pitch, Duplex .....	E-131 – E-132
ISO - 12B-3, Metric 60-3 - 0.750" (19.05 mm) Pitch, Triplex .....	E-133
ISO - 16B-1, Metric 80 - 1.000" (25.40 mm) Pitch, Simplex .....	E-134 – E-135

## **ROLLER CHAIN SPROCKETS**

**PRODUCT**

**PAGE**

**SECTION II – METRIC SPROCKETS (continued)**

ISO - 16B-2, Metric 80-2 - 1.000" (25.40mm) Pitch, Duplex.....	E-136 – E-137
ISO - 16B-3, Metric 80-3 - 1.000" (25.40mm) Pitch, Triplex.....	E-138
ISO - 20B-1, Metric 100 - 1.250" (31.75mm) Pitch, Simplex.....	E-139 – E-140
ISO - 20B-2, Metric 100-2 - 1.250" (31.75mm) Pitch, Duplex.....	E-141
ISO - 20B-3, Metric 100-3 - 1.250" (31.75mm) Pitch, Triplex.....	E-142
ISO - 24B-1, Metric 120 - 1.500" (38.10mm) Pitch, Simplex.....	E-143 – E-144
ISO - 24B-2, Metric 120-2 - 1.500" (38.10mm) Pitch, Duplex.....	E-145
ISO - 28B-1, Metric 140 - 1.750" (44.45mm) Pitch, Simplex.....	E-146 – E-147
ISO - 28B-2, Metric 140-2 - 1.750" (44.45mm) Pitch, Duplex.....	E-148
ISO - 32B-1, Metric 160 - 2.00" (50.80mm) Pitch, Simplex.....	E-149 – E-150
ISO - 32B-2, Metric 160-2 - 2.00" (50.80mm) Pitch, Simplex.....	E-151

**SECTION III – ENGINEERING.....E-152 – E-192**

Sprocket Nomenclature.....	E-153 – E-155
Roller Chain Dimensions.....	E-156
Sprocket Tooth Dimensions.....	E-157
Maximum Bore and Hub Size.....	E-158 – E-159
Sprocket Selection.....	E-160 – E-163
Sprocket Engineering.....	E-164 – E-166
Hardening.....	E-167
Chain Drive Engineering.....	E-168 – E-169
Roller Chain Lengths.....	E-169
Speed Ratios.....	E-170
Sprocket Diameters.....	E-171 – E-183
Horsepower Ratings.....	E-184 – E-192



**Multi-Strand Oil Field Sprocket with Clutch Jaws**



**Triple 160 Shaft Sprocket**



**Quadruple 160 Sprocket**



**Triple 200 Sprocket**



**Double 200 Sprocket and Pinion**



**Large Triple Strand Sprocket with Mounting Flange**



**Sprocket with Mud Relief**



**Standard RC Sprocket with Spline Bore**



**Special Dryer Sprocket**



**Special Plastic Sprocket**



**Block Chain**

*Martin* manufactures numerous Made-To-Order (MTO) sprockets. If you do not see the sprocket you need in this section, call us. Chances are if chain runs on it, we have made the sprocket before. Special materials, special bores, duplex, triplex, double-single-doubles, etc. are all familiar to *Martin*.

# Bolt-On Shear Pin Sprockets

Shear Pin sprockets provide simple, dependable protection against expensive machinery damage caused by overloads or jamming. Torque is transmitted by a single pin, necked to shear when the safe load is exceeded. When an overload occurs, the pin shears, disconnecting the drive immediately.

The Bolt-on Shear Pin Adapter converts any plate sprocket into a stock Shear Pin sprocket allowing immediate delivery of stock Shear Pin sprockets.

Selection guide on page E-6 gives complete procedure to select the proper Shear Pin assembly.



## Notes on Pricing:

**Shear Pin Hub List Price** includes any finished bore within the stated range, standard keyway, setscrew, and hardened steel shear pin bushing.

**Shear Pin Adapter List Price** includes the Shear Pin bushin and grease fitting.

**Complete Assembly List Price** includes all components of the Shear Pin assembly as described above. Total list price of any Shear Pin sprocket is the complete assembly list price plus the list price of the desired plate sprocket (from tables of stock sprocket list prices).

**Replacement Sprockets** should be priced as altered stock sprockets directly from List Price and Alteration Charge tables.

**Shear Pin Components** may be ordered separately and will be treated as stock items when conforming to standard specifications and descriptions above.

## Stock Shear Pin Assemblies

Shear Pin Assembly Number	Hub Bore Range	Shear Pin Hub	Shear Pin Adapter
		Catalog Number	Catalog Number
SP-17	1" & UNDER	SPH-17	SPA-17
SP-18	1 <sup>1</sup> / <sub>16</sub> - 1 <sup>1</sup> / <sub>4</sub>	SPH-18	SPA-18
SP-19	1 <sup>1</sup> / <sub>16</sub> - 1 <sup>1</sup> / <sub>2</sub>	SPH-19	SPA-19
SP-20	1 <sup>1</sup> / <sub>8</sub> - 1 <sup>3</sup> / <sub>4</sub>	SPH-20	SPA-20
SP-21	1 <sup>1</sup> / <sub>8</sub> - 2	SPH-21	SPA-21
SP-22	2 <sup>1</sup> / <sub>16</sub> - 2 <sup>1</sup> / <sub>4</sub>	SPH-22	SPA-22
SP-23	2 <sup>1</sup> / <sub>16</sub> - 2 <sup>1</sup> / <sub>2</sub>	SPH-23	SPA-23
SP-24	2 <sup>1</sup> / <sub>16</sub> - 2 <sup>3</sup> / <sub>4</sub>	SPH-24	SPA-24
SP-25	2 <sup>1</sup> / <sub>16</sub> - 3	SPH-25	SPA-25
SP-26	3 <sup>1</sup> / <sub>16</sub> - 3 <sup>1</sup> / <sub>2</sub>	SPH-26	SPA-26
SP-27	3 <sup>3</sup> / <sub>16</sub> - 4	SPH-27	SPA-27
SP-28	4 <sup>1</sup> / <sub>16</sub> - 4 <sup>1</sup> / <sub>2</sub>	SPH-28	SPA-28
SP-29	4 <sup>3</sup> / <sub>16</sub> - 5	SPH-29	SPA-29
SP-30	4 <sup>7</sup> / <sub>16</sub> - 5 <sup>1</sup> / <sub>2</sub>	SPH-30	SPA-30
SP-31	5 <sup>1</sup> / <sub>16</sub> - 6	SPH-31	SPA-31

## Pricing Examples:

### 1. Stock Shear Pin Sprocket

To price a 35 tooth shear pin sprocket for 160 chain (160SP35) using SP-26 shear pin assembly with 3<sup>1</sup>/<sub>16</sub>" bore, standard keyway and setscrew:

SP-26 Assembly List Price .....  
160A35 List Price .....  
Total List Price .....

See List  
Price Sheet

### 2. Shear Pin Adapter and Sprocket for Existing Hub

To price a "Bolt-on" shear pin adapter and sprocket to replace the sprocket part of existing 50SP40 using SP-19 hub:

SPA-19 Adapter List Price.....  
50A40 List Price .....  
Total List Price .....

See List  
Price Sheet

*Shear Pin Sprockets can also be furnished in other standard styles or made to customer's specifications. Price on application.*

*It is important that the torque requirement for the selected hub be checked in the torque rating table on page E-6 and the neck diameter of Shear Pin be specified.*

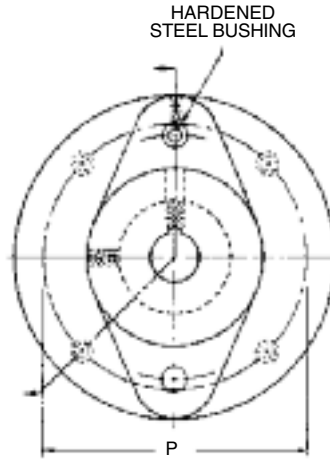
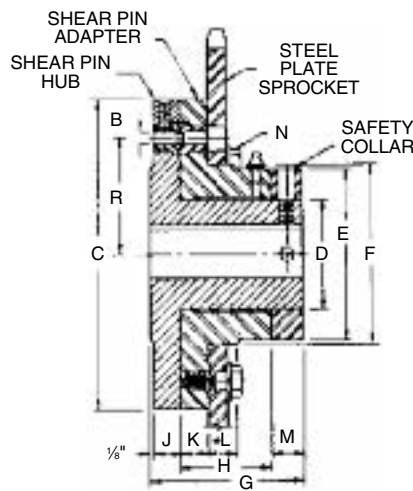

### Shear Pin Assembly Dimensions (Inches)

### Table I

Shear Pin Assembly Number	Shear Pin		Diameters				Length Thru			Hub Flange Thickness	Adapt. Flange Thickness	Sprocket Seat Width	Bolts		Weights Lbs. (Approx.)	
	Radius R	Pin Dia. B	Flange C	Shear Pin Hub D	Adapt. Hub & Collar E	Sprocket Seat F	Shear Pin Hub G	Adapt. H	Collar M				Number & Size N	Bolt Circle P	Shear Pin Hub	Shear Pin Adapt.
SP-17	1 1/16"	1/4"	5 1/4"	1 1/4"	2 1/2"	2 3/8"	2 1/8"	1 1/8"	3/8"	9/16"	7/16"	4 - 3/8"	4	2.7	3.2	
SP-18	2 1/16"	1/4"	6"	2 1/4"	3 1/4"	3 3/8"	2 5/8"	1 1/2"	1/2"	9/16"	9/16"	4 - 3/8"	4 3/4"	4.6	4.7	
SP-19	2 1/8"	5/16"	6 1/2"	2 3/4"	4"	4 1/8"	3 1/8"	2 1/8"	3/8"	1 1/16"	1 1/16"	4 - 1/2"	5 1/2"	7.2	7.6	
SP-20	3"	3/8"	7 1/4"	3 1/4"	4 1/4"	4 3/8"	4 1/8"	2 1/2"	3/8"	1 1/16"	1 3/16"	4 - 1/2"	6 1/4"	11.0	11.9	
SP-21	3 3/16"	7/16"	8"	3 3/8"	5 1/4"	5 3/8"	4 13/16"	2 7/8"	7/8"	1 1/16"	1 3/16"	4 - 5/8"	7"	16.2	16.9	
SP-22	3 3/8"	1/2"	9 1/4"	4 1/4"	6 1/4"	6 3/8"	5 5/8"	3"	1"	1 1/16"	1 3/16"	4 - 5/8"	8"	23.3	24.5	
SP-23	4"	1/2"	10"	4 1/2"	6 1/2"	6 3/8"	5 11/16"	3 1/2"	1"	1 1/16"	1 1/16"	4 - 5/8"	8 1/4"	26.3	27.7	
SP-24	4 1/8"	5/8"	11 1/2"	5"	7"	7 1/8"	6 3/8"	3 3/8"	1 1/8"	1 1/16"	1 3/16"	4 - 5/8"	9 1/4"	40.4	38.6	
SP-25	4 1/4"	5/8"	12 1/2"	5 1/2"	8"	8 1/8"	6 5/8"	4 1/4"	1 1/4"	1 1/16"	1 3/16"	6 - 5/8"	10 1/4"	52.6	53.6	
SP-26	5 3/16"	1 1/16"	13 1/2"	6 1/4"	8 3/8"	8 3/8"	7 13/16"	4 7/8"	1 3/8"	1 1/16"	1 3/16"	6 - 3/4"	11 1/4"	66.7	66.8	
SP-27	6 1/16"	3/4"	15 1/2"	7"	10"	10 1/8"	8 11/16"	5 1/2"	1 1/2"	1 1/16"	1 1/2"	6 - 3/4"	12 1/4"	96.5	100.0	
SP-28	6 1/8"	3/4"	16 1/4"	7 1/4"	10 3/4"	10 3/4"	9 11/16"	6 1/2"	1 1/2"	1 1/16"	1 1/2"	6 - 3/4"	13 1/2"	125.0	115.0	
SP-29	7"	7/8"	17 1/2"	8 1/2"	12"	12 1/8"	10 11/16"	7"	1 1/4"	1 1/16"	1 1/2"	6 - 1"	14 1/4"	160.0	150.0	
SP-30	8 1/8"	1"	20 1/4"	9 1/4"	13 3/4"	13 3/8"	11 11/16"	7 1/2"	2"	2 1/16"	1 1/2"	6 - 1"	17"	215.0	207.0	
SP-31	8 1/4"	1 1/8"	22 1/2"	10 1/4"	15"	15 1/8"	12 5/8"	8 1/4"	2 1/4"	2 1/16"	1 1/2"	6 - 1"	18 3/4"	318.0	265.0	

NOTE: Shear Pin "Pin" length equals 2 x "J" dimension.

### Sprocket Sizes For Stock Shear Pin Assemblies

### Table II

Shear Pin Assembly Number	Hub Bore Range	Minimum Number of Teeth for Single Sprockets												
		Chain Number												
		35	41	40	50	60	80	100	120	140	160	180	200	240
SP-17	1" & UNDER	48	37	37	30	26	—	—	—	—	—	—	—	—
SP-18	1 1/16" - 1 1/4"	55	42	42	34	29	23	—	—	—	—	—	—	—
SP-19	1 1/8" - 1 1/2"	61	46	47	38	32	25	21	—	—	—	—	—	—
SP-20	1 1/16" - 1 1/4"	69	53	53	43	36	28	23	—	—	—	—	—	—
SP-21	1 1/8" - 2"	78	59	59	48	41	31	26	22	19	—	—	—	—
SP-22	2 1/16" - 2 1/4"	86	65	66	53	45	34	28	24	21	19	17	—	14
SP-23	2 3/16" - 2 1/2"	89	67	67	55	46	35	29	25	22	19	18	16	14
SP-24	2 1/8" - 2 3/4"	101	76	77	62	52	40	33	28	24	22	20	18	16
SP-25	2 3/8" - 3"	110	83	83	67	56	43	35	30	26	23	21	19	17
SP-26	3 1/16" - 3 1/2"	—	98	98	72	61	46	38	32	28	25	23	20	18
SP-27	3 3/8" - 4"	—	102	102	82	69	53	43	36	32	28	25	23	20
SP-28	4 1/16" - 4 1/2"	—	107	107	86	72	55	45	38	33	29	26	24	21
SP-29	4 3/8" - 5"	—	—	—	92	77	59	48	40	35	31	28	26	22
SP-30	5 1/16" - 5 1/2"	—	—	—	106	89	68	55	46	40	35	32	29	25
SP-31	5 3/8" - 6"	—	—	—	—	98	75	61	51	44	39	35	32	27

# Bolt-On Shear Pin Sprockets



## Shear Pin Sprocket Selection

1. The shear pin assembly required is determined by the shaft size. Select the smallest shear pin assembly which will accommodate the required bore. Table on page E-5 contains the bore ranges and minimum sprocket sizes which allow chain clearance over the shear pin assembly flange.
2. Using one of the following formulas, compute the torque load the pin must transmit and find the value in the torque rating table below to obtain the proper shear pin neck diameter.

$$T = \frac{HP \times 63,025 \times 1.5}{RPM} \quad \text{or} \quad T = \frac{D \times CP \times 1.5}{2}$$

or T = Output of reducer x speed ratio of chain drive x 1.5

Where: T = Torque in pound inches  
 HP = Horsepower at Sprocket  
 RPM = Sprocket Speed  
 D = Pitch Diameter of Sprocket  
 CP = Chain pull in pounds  
 1.5 = Safety factor for starting load

### Example:

1. Determine the shear pin assembly and pin neck diameter to transmit 20 horsepower at 67 RPM with a 45 tooth, No. 100 sprocket on a 2<sup>15</sup>/<sub>16</sub>" shaft.

(1) Referring to Table II (page E-5), shear pin assembly SP-25 is required for a 2<sup>15</sup>/<sub>16</sub>" bore. The 45 tooth sprocket is well above the minimum size.

(2) Torque and neck diameter:

$$T = \frac{HP \times 63,025 \times 1.5}{RPM}$$

$$T = \frac{20 \times 63,025 \times 1.5}{67} = 28,200 \text{ lb. in.}$$

Referring to Table III (below) under SP-25, a pin necked to <sup>3</sup>/<sub>8</sub>" shows a torque rating of 29,810 lb. in., which exceeds the 28,200 lb. in. required.

(3) Order: 100SP45, SP-25 assembly with 2<sup>15</sup>/<sub>16</sub>" bore and <sup>3</sup>/<sub>8</sub>" pin neck diameter.

## Shear Pin Torque Ratings

Table III

Shear Pin Neck Diameter (inches)	TORQUE RATING — POUND INCHES														
	Shear Pin Hub Number														
	SP17	SP18	SP19	SP20	SP21	SP22	SP23	SP24	SP25	SP26	SP27	SP28	SP29	SP30	SP31
<sup>3</sup> / <sub>32</sub>	728	875	1022	1204	1323	1556	1603								
<sup>1</sup> / <sub>16</sub>	1248	1500	1752	2064	2268	2616	2748								
<sup>5</sup> / <sub>32</sub>	1976	2375	2774	3268	3591	4142	4351	4750							
<sup>3</sup> / <sub>16</sub>	2808	3375	3942	4944	5103	5886	6183	6750	7317						
<sup>7</sup> / <sub>32</sub>	3848	4625	5402	6364	6993	8066	8473	9250	10027						
<sup>1</sup> / <sub>4</sub>	5200	6250	7300	8600	9450	10900	11450	12500	13550	15200	17300	18400			
<sup>9</sup> / <sub>32</sub>			9052	10664	11718	13516	14198	15500	16802	18848	21452	22816			
<sup>5</sup> / <sub>16</sub>			11096	13072	14364	16568	17403	19000	20596	23140	26296	27968	30932		
<sup>11</sup> / <sub>32</sub>				15824	17388	20056	21068	23000	24932	27968	31832	33856	37440		
<sup>3</sup> / <sub>8</sub>				18920	20790	23980	25190	27500	29810	33440	38060	40480	44770	51040	
<sup>13</sup> / <sub>32</sub>					24570	28340	29170	32500	35230	39520	44980	47840	52910	60320	
<sup>7</sup> / <sub>16</sub>					28350	32700	34350	37500	41650	45600	51900	55200	61050	69600	
<sup>15</sup> / <sub>32</sub>						37060	38930	42500	46070	51680	58820	62560	69190	78880	
<sup>1</sup> / <sub>2</sub>						42728	44884	49000	53116	59584	67816	72128	79772	90944	
<sup>17</sup> / <sub>32</sub>								55000	59620	66880	76120	80960	89540	102080	
<sup>9</sup> / <sub>16</sub>								62000	67280	75392	85808	91264	100936	115072	
<sup>19</sup> / <sub>32</sub>									73220	82080	93420	99360	109890	125280	136890
<sup>5</sup> / <sub>8</sub>									82800	92720	105530	112240	124135	141520	154635
<sup>21</sup> / <sub>32</sub>										103360	117640	126120	138380	157760	172380
<sup>11</sup> / <sub>16</sub>										112480	128020	136160	150590	171680	187590
<sup>23</sup> / <sub>32</sub>											138400	147200	162800	185600	202800
<sup>3</sup> / <sub>4</sub>											152240	161920	179080	204160	223080
<sup>25</sup> / <sub>32</sub>													195360	222720	243360
<sup>13</sup> / <sub>16</sub>													211640	241280	263640
<sup>27</sup> / <sub>32</sub>													227920	259840	283920
<sup>7</sup> / <sub>8</sub>													244200	278400	304200
<sup>29</sup> / <sub>32</sub>														296960	324480
<sup>15</sup> / <sub>16</sub>														301600	329550
<sup>31</sup> / <sub>32</sub>														338720	370110
1														371200	405600
1 <sup>1</sup> / <sub>16</sub>															446160
1 <sup>1</sup> / <sub>8</sub>															507000

## Type D Sprockets — Stock Detachable Hubs

Type D sprockets consist of a Type A plate sprocket bolted to a detachable hub. A solid or split plate sprocket may be assembled to a solid or split hub. When ordering a Type D sprocket, be sure to select a plate sprocket large enough to allow chain clearance over the hub flange diameter, dimension D.

Bolt holes of Type D hubs are drilled for interchangeability. Speed ratios may be changed simply by removing the plate sprocket and substituting another with a different number of teeth. When worn, the sprocket may be reversed to use the unworn tooth surfaces, increasing the life of the sprocket.

## Split Hubs-Cast Iron — Dimensions (Inches)

Hub Number	Bore Range A		Hub Diameter B	Bolt Circle C	Flange Diameter D	Bolt Holes		E	F	L	Wt. Lbs. (Approx.)
	Stock	*Maximum				Number	Bolt Size				
102S	1 <sup>1</sup> / <sub>16</sub>	1 <sup>1</sup> / <sub>2</sub>	3	4	5	4	7 <sup>1</sup> / <sub>16</sub>	1 <sup>1</sup> / <sub>4</sub>	1 <sup>1</sup> / <sub>2</sub>	3 <sup>3</sup> / <sub>4</sub>	7.7
103S	1 <sup>1</sup> / <sub>16</sub>	2 <sup>1</sup> / <sub>4</sub>	4	5 <sup>1</sup> / <sub>16</sub>	6	4	1/2	2	1 <sup>1</sup> / <sub>2</sub>	3 <sup>1</sup> / <sub>2</sub>	14.5
104S	2 <sup>1</sup> / <sub>16</sub>	2 <sup>1</sup> / <sub>2</sub>	4 <sup>1</sup> / <sub>2</sub>	5 <sup>1</sup> / <sub>2</sub>	7	4	5/8	2 <sup>1</sup> / <sub>4</sub>	1 <sup>1</sup> / <sub>4</sub>	4	18.3
105S	2 <sup>1</sup> / <sub>16</sub>	2 <sup>3</sup> / <sub>4</sub>	5	6 <sup>1</sup> / <sub>4</sub>	7 <sup>1</sup> / <sub>2</sub>	4	5/8	2 <sup>1</sup> / <sub>4</sub>	1 <sup>1</sup> / <sub>2</sub>	4 <sup>1</sup> / <sub>2</sub>	23.6
106S	2 <sup>1</sup> / <sub>16</sub>	3 <sup>1</sup> / <sub>4</sub>	5 <sup>1</sup> / <sub>2</sub>	7	8 <sup>1</sup> / <sub>2</sub>	4	5/8	2 <sup>1</sup> / <sub>2</sub>	2	4 <sup>1</sup> / <sub>2</sub>	28.2
107S	3 <sup>1</sup> / <sub>16</sub>	3 <sup>1</sup> / <sub>2</sub>	6	7 <sup>1</sup> / <sub>2</sub>	9	4	5/8	3	1 <sup>1</sup> / <sub>4</sub>	4 <sup>3</sup> / <sub>4</sub>	37.4
108S	3 <sup>1</sup> / <sub>16</sub>	4	7	8 <sup>1</sup> / <sub>2</sub>	10 <sup>1</sup> / <sub>2</sub>	4	3/4	3 <sup>3</sup> / <sub>4</sub>	1 <sup>1</sup> / <sub>2</sub>	5 <sup>1</sup> / <sub>2</sub>	55.1
109S	4 <sup>1</sup> / <sub>16</sub>	6	10 <sup>1</sup> / <sub>2</sub>	13	15 <sup>1</sup> / <sub>2</sub>	4	1	4 <sup>1</sup> / <sub>2</sub>	1 <sup>1</sup> / <sub>2</sub>	5 <sup>1</sup> / <sub>2</sub>	155.0

\*Maximum bores shown are maximum bores with standard keyseat and setscrew.

To obtain the price of a complete Type D sprocket, add the list price of hub, plus alteration charges and the list price of the desired Type A plate sprocket, including rebore, bolt hole drilling, and splitting charge if desired. These hubs may also be used with Accu-Torch Sprockets.

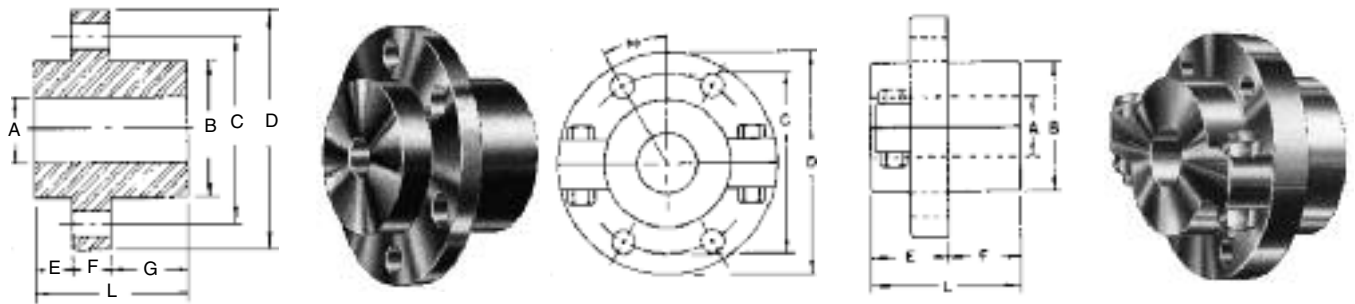

### Alteration Charges

See current discount sheet for alteration charges.

## Solid Hubs-Steel — Dimensions (Inches)

Hub Number	Bore Range A		Hub Diameter B	Bolt Circle C	Flange Diameter D	Bolt Holes		E	F	G	L	Wt. Lbs. (Approx.)
	Stock	*Maximum				Number	Bolt Size					
101	5/8	1 <sup>1</sup> / <sub>4</sub>	2 <sup>1</sup> / <sub>2</sub>	3 <sup>3</sup> / <sub>4</sub>	4 <sup>1</sup> / <sub>4</sub>	6	3/8	1/2	3/8	1 <sup>1</sup> / <sub>4</sub>	2	3.4
102	1 <sup>1</sup> / <sub>16</sub>	2	3	4	5	6	7 <sup>1</sup> / <sub>16</sub>	1/2	1/2	1 <sup>1</sup> / <sub>2</sub>	2 <sup>1</sup> / <sub>2</sub>	5.4
103	1 <sup>1</sup> / <sub>16</sub>	2 <sup>1</sup> / <sub>2</sub>	4	5 <sup>1</sup> / <sub>16</sub>	6	6	1/2	1/2	5/8	1 <sup>1</sup> / <sub>2</sub>	2 <sup>1</sup> / <sub>2</sub>	10.2
104	2 <sup>1</sup> / <sub>16</sub>	3	4 <sup>1</sup> / <sub>2</sub>	5 <sup>1</sup> / <sub>2</sub>	7	6	5/8	1/2	3/4	2	3 <sup>1</sup> / <sub>4</sub>	14.2
105	2 <sup>1</sup> / <sub>16</sub>	3 <sup>1</sup> / <sub>4</sub>	5	6 <sup>1</sup> / <sub>4</sub>	7 <sup>1</sup> / <sub>2</sub>	6	5/8	9/16	15/16	2 <sup>1</sup> / <sub>2</sub>	4	22.2
106	2 <sup>1</sup> / <sub>16</sub>	3 <sup>1</sup> / <sub>4</sub>	5 <sup>1</sup> / <sub>2</sub>	7	8 <sup>1</sup> / <sub>2</sub>	6	5/8	5/8	1	2 <sup>1</sup> / <sub>2</sub>	4	28.4
107	3 <sup>1</sup> / <sub>16</sub>	4	6	7 <sup>1</sup> / <sub>2</sub>	9	6	5/8	5/8	1 <sup>1</sup> / <sub>4</sub>	2 <sup>1</sup> / <sub>2</sub>	4 <sup>1</sup> / <sub>2</sub>	34.7
108	3 <sup>1</sup> / <sub>16</sub>	4 <sup>1</sup> / <sub>2</sub>	7	8 <sup>1</sup> / <sub>2</sub>	10 <sup>1</sup> / <sub>2</sub>	6	3/4	5/8	1 <sup>1</sup> / <sub>2</sub>	2 <sup>1</sup> / <sub>2</sub>	4 <sup>1</sup> / <sub>2</sub>	52.4
109	4 <sup>1</sup> / <sub>16</sub>	7	10 <sup>1</sup> / <sub>2</sub>	13	15 <sup>1</sup> / <sub>2</sub>	6	1	3/4	1 <sup>1</sup> / <sub>2</sub>	2 <sup>1</sup> / <sub>2</sub>	5	143.0

\*Maximum bores shown are maximum bores with standard keyseat and setscrew.

# All Steel Instant Split<sup>®</sup> Sprocket

Manufactured from stock plate sprockets, *Martin's* Instant Split-Sprocket offers unlimited design and is simply installed with a hand wrench . . . greatly reducing costly downtime.



## Single-Style B and C — Steel-Instant Split-Sprocket

Hub Number	Bore	Hub O.D.	Hub* Length	Bolts	Wt. Lbs. (Approx.)
S-1	3/4" - 1 1/2"	3 3/8"	1"	3/8" x 2 1/2"	1.8
S-2	1 3/8" - 2 1/4"	4 3/8"	1 1/4"	1/2" x 3"	4.1
S-3	2" - 3"	6"	1 3/8"	5/8" x 4 1/2"	8.4
S-4	2 3/4" - 4"	7 5/8"	1 1/2"	3/4" x 5 1/2"	14.4
S-5	3 3/4" - 5"	9 1/4"	2"	1" x 6"	27.8
S-6	4 3/4" - 6"	10 1/4"	2 1/4"	1" x 6"	35.4
S-7	5 3/4" - 7"	12 1/2"	2 1/2"	1" x 7"	64.4
S-8	6 1/4" - 8"	14 1/2"	3"	1" x 8"	98.5

\*Add hub length to plate thickness to determine length thru bore.

For style C, add hub length x 2.

**TOTAL LIST PRICE OF *Martin* SPLIT-SPROCKET IS SIMPLY THE HUB PRICE PLUS THE PLATE PRICE.**

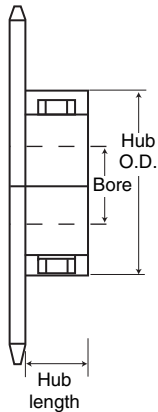

### PRICING EXAMPLE STYLE B

**120B45 Split with S-3 Hub,  
2 15/16" Bore, KW & SS**

**S-3 Hub  
120A45 Plate**

SEE HUB LIST  
+ SEE PLATE LIST  
TOTAL LIST PRICE

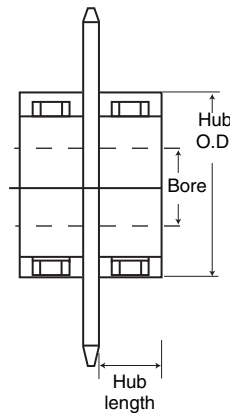

### PRICING EXAMPLE STYLE C

**120C45 Split with S-3 Hubs,  
2 15/16" Bore, KW & SS**

**Two S-3 Hubs  
120A45 Plate**

SEE HUB LIST  
+ SEE PLATE LIST  
TOTAL LIST PRICE

Instant Split Hubs are for use with plate sprockets only. For multiple strand split sprockets, consult *Martin*.

## Sprocket Size For Instant Split Hubs

Split Hub No.	Bore	Minimum Number of Teeth for Single Sprockets										
		Chain Number										
		40	50	60	80	100	120	140	160	180	200	240
S-1	3/4" - 1 1/2"	28	23	20	16	—	—	—	—	—	—	—
S-2	1 3/8" - 2 1/4"	38	30	26	20	17	15	14	—	—	—	—
S-3	2" - 3"	46	37	32	25	20	18	16	15	14	—	—
S-4	2 3/4" - 4"	—	48	40	30	25	21	19	17	16	15	12
S-5	3 3/4" - 5"	—	—	—	—	30	25	22	20	18	17	14
S-6	4 3/4" - 6"	—	—	—	—	32	27	24	22	19	18	15
S-7	5 3/4" - 7"	—	—	—	—	—	32	28	25	22	21	18
S-8	6 1/4" - 8"	—	—	—	—	—	—	—	28	25	23	20



**Martin TORQUE-LIMITER clutch offers thrifty overload protection that's easy to adjust.**

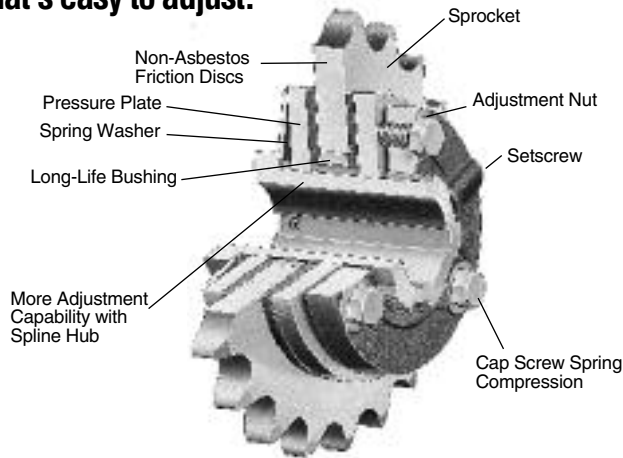

Here is low cost protection for your machinery . . . a torque limiting clutch that is easy to install.

Torque-Limiter clutches feature an exclusive "Easy-Set Adjustment." With "Easy-Set," torque adjustment is accomplished quickly! The need for hammer and block, brute strength, and spanner wrenches is eliminated.

These simple steps and the job is done:

1. Snug up the adjusting nut, finger tight, locate set screw over nearest spline notch, and tighten. See table at right.
2. Tighten three cap screws until heads bottom — with a small wrench; this gives maximum torque.
3. For less torque — back off the cap screws, loosen the set screw, back off adjusting nut to one of the six spline notches as required, and retighten set screw and cap screws.

"Easy-Set Adjustment" not only simplifies installation, it provides solid support for pressure plates by compression at their peripheries.

The Torque-Limiter clutch gives machinery permanent protection against overloads during starting, reversing, or driving — by slipping at any desired load. It resumes driving without resetting when the overload is relieved. It is simple in design, compact, efficient, and built for long life. It provides low cost torque limiting service for a wide variety of applications. No lubrication . . . minimum maintenance.

Starting shock from electric motors is a major cause of maintenance of moving parts. Torque-Limiter clutches provide a cushion by slipping until the torque drops to a pre-set level. They can be set to reduce shock loads on motors and driven equipment during reversing or inching. They provide mechanical protection against breakage due to sudden overload — by slipping when the pre-set torque limit is reached.

Torque-Limiter clutches may be used with a sprocket, gear, sheave, flange, or other driven member. It is recommended that the rubbing sides of the driven member be ground to provide a smooth rubbing surface of 63 to 125 micro-inches. See torque rating table on following page.

The driven member is mounted on an oil-impregnated bushing and clamped between two, high quality friction discs by spring pressure. Each Torque-Limiter unit, completely assembled, contains one spring. Higher torque ratings can be obtained by the use of a second spring nested within the original spring. See rating table on following page.

When an overload occurs, the driven member slips between long-life, clutch-type friction discs. After slipping has started, it will continue at approximately 90% of the torque setting, due to the lower coefficient of friction when slipping, until the overload condition has been corrected.

### TORQUE-LIMITER CLUTCH CALIBRATION

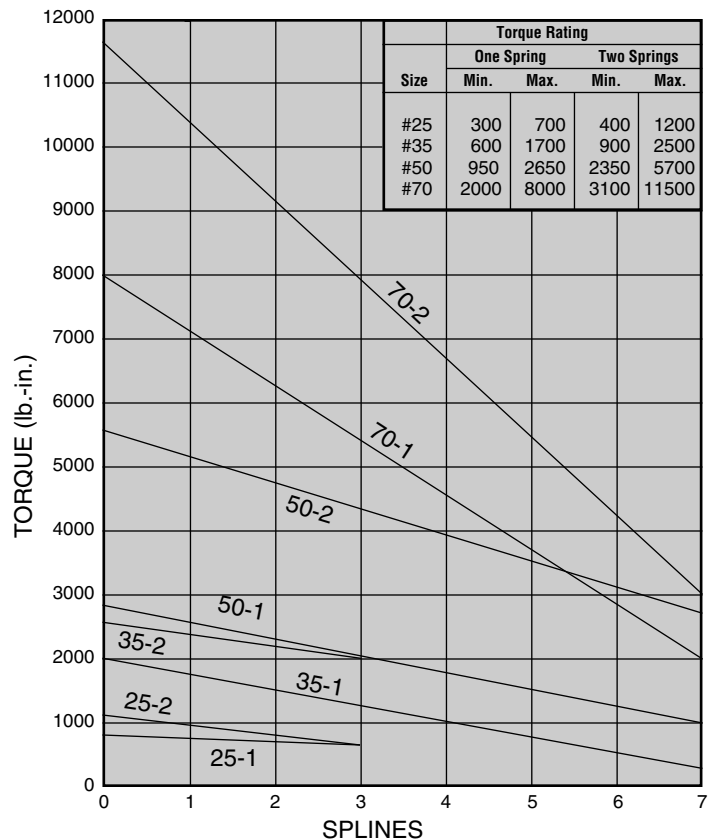

**Note:**

Graph indicates approximate rated torque vs. number of splines adjusting nut is backed off from finger tight.

# Torque-Limiter Clutches



## TORQUE-LIMITER CLUTCHES



Each assembled unit contains one spring. Higher ratings can be obtained by ordering a second spring to nest in the original one. Bushings need to be ordered separately, if required.

The rubbing sides of the center member should be ground parallel — 63 to 125 micro-inches.

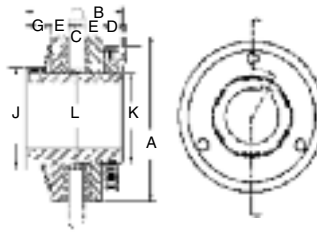

## Torque-Limiter Clutch Ratings

Size No.	Avg. Wt.	Torque Rating ▲ (Pound-Inches)				C										K +.000 -.002 Spline O. D.	L +.003 -.000 Spkt. Bore
		With One Spring		With Two Springs**		A	B	Min.		D	E	G	H	J			
		Min.	Max.	Min.	Max.			Min.	Max.								
TT25	1.0	300	700	400	1200	2½	1¾	½	½	2/64	1/64	1/64	2½	1¾	1.368	1.631/1.628	
TT35	2.5	600	1700	900	2500	3½	2½	½	¾	3/64	2/64	3/64	3¾	1½	1.675	2.006/2.003	
TT50	6.0	950	2650	2350	5700	5	2½	¾	¾	5/64	2/64	2½	4¾	2½	2.625	3.008/3.005	
TT70	18.0	2100	8000	3100	11500	7	3¾	¾	1½	3/64	3/64	2½	6	4	3.811	4.197/4.194	

▲ Using a center member with rubbing sides ground parallel — 63 to 125 micro-inches. Center member must be clean and free from oil, rust, etc.

\*\* Second spring may be nested in one originally furnished. Order if required.

Nominal for maximum torque setting. For minimum torque setting, add 3/64" for No. 25; 5/64" for No. 35; 3/32" for Nos. 50 and 70. When two springs are used this dimension is increased approximately 1/16" on Nos. 25, 35 and 50 — 3/32" on No. 70.

## Stock Bores — Torque Limiters (No KW 1-SS†)

Size No.	Stock Bore	Max. Bore	
		Std. KW*	Shallow KW*
TT25	½	¾	1
TT35	¾	1 1/16	1 ¼
TT50	1	1 ¼	2
TT70	1 ¼	2 ¼	3

† For additional SS see List Price Alterations.

\* KW to be cut central w/threaded spline.

## Standard Keyways

Torque-Limiter Bore	Keyway	Torque-Limiter Bore	Keyway
½ - ¾	½ x 1/16	1 1/16 - 1 ¼	¾ x 3/16
¾ - 1	¾ x 3/32	1 1/16 - 2 ¼	½ x ¼
1 - 1 ¼	¼ x ½	2 1/16 - 2 ¾	¾ x 3/16
1 1/16 - 1 ½	1/8 x 5/32	2 1/16 - 3	¾ x 3/8

## Bored to Size Torque Limiters w/Std. KW & 1-SS†

Size No.	Finished Bores										
	½	¾	1	1 1/16	1 ¼	1 ½	1 ¾	2	2 1/16	2 ¼	2 ½
TT25	½	¾	1								
TT35		¾	1								
TT50			1	1 1/16	1 ¼	1 ½	1 ¾	2			
TT70						1 1/16	1 ½	2	2 1/16	2 ¼	2 ½

† KW same as std. listed in tables above. For additional SS see List Price.

Unit Size	Sprocket Pitch	Min. Allowable Sprocket Teeth and Length of Bushing Req'd for Chain Number										
		35	41	40	50	60	80	100	120	140	160	
TT25	Min. Teeth	STOCK ★	25	19	19	16	..	..	..	..	..	..
		MTO ●	25	19	19	16	..	..	..	..	..	..
	Bush. Lght. Req'd.		¾	¾	¾	¾	..	..	..	..	..	..
TT35	Min. Teeth	STOCK ★	35	25	26	21	18	15	..	..	..	..
		MTO ●	33	25	26	21	18	15	..	..	..	..
	Bush. Lght. Req'd.		¾	¾	¾	¾	¾	¾	..	..	..	..
TT50	Min. Teeth	STOCK ★	48	35	35	29	25	19	..	..	..	..
		MTO ●	46	35	35	29	25	19	..	..	..	..
	Bush. Lght. Req'd.		¾	¾	¾	¾	¾	¾	..	..	..	..
TT70	Min. Teeth	STOCK ★	..	..	48	38	33	26	21	18	16	14
		MTO ●	..	..	48	38	33	26	21	18	16	14
	Bush. Lght. Req'd.		..	..	¾	¾	¾	¾	¾	¾*	¾*	1♦

★ Min. number of teeth on sprocket stocked by Martin which can be used w/Torque-Limiter clutch.

● Min. number of teeth on made-to-order sprocket which will permit chain to clear friction disc.

\* Use one 3/8" long bushing and one 1/2" long.

♦ Use two 1/2" long bushings.

## Stock Plate Sprockets with Ground Face and Bored to Fit the Martin Torque Limiter

### UNIT TT25

Sprocket Size
35TTA25-25
35TTA26-25
40TTA20-25
40TTA22-25
40TTA24-25
40TTA28-25
40TTA30-25
50TTA17-25
50TTA21-25
50TTA22-25

### UNIT TT35

Sprocket Size
35TTA35-35
35TTA40-35
40TTA28-35
40TTA30-35
40TTA32-35
50TTA22-35
50TTA24-35
50TTA25-35
50TTA26-35
60TTA18-35
60TTA20-35

### UNIT TT50

Sprocket Size
40TTA35-50
50TTA30-50
50TTA32-50
60TTA25-50
60TTA26-50
60TTA28-50
60TTA30-50
80TTA20-50
80TTA22-50
80TTA24-50

### UNIT TT70

Sprocket Size
60TTA36-70
80TTA26-70
80TTA28-70
80TTA30-70
80TTA36-70
100TTA22-70
100TTA24-70

## SPARE PARTS

TT25 TT50 TT35 TT70	QTY. REQ. *
PRESSURE PLATE	2
FRICTION DISC	2
ADJ. NUT ASSY. & S.S.	1
ADJ. TENSION NUT	3
HUB	1

\* PER UNIT





**Standard Roller  
Double Duty**



**Carrier  
Roller**

## Double-Pitch Sprockets

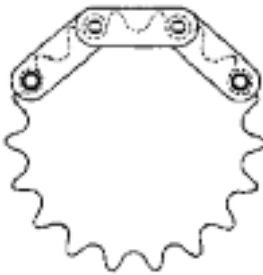

**Standard Rollers**



**Double Pitch  
Single Duty  
Made-To-Order**



**Carrier Rollers**

Series C-2000 chains have rollers of the same diameters and widths as American Standard Roller Chains of one half the conveyor chain pitch. Engaged by every other tooth, double duty sprockets have two teeth per chain pitch. During each revolution only half the teeth function effectively. Sprockets with odd numbers of teeth will allow any given tooth to engage only on every other revolution, automatically increasing sprocket life. Double duty sprockets with even number of teeth may be manually advanced one tooth periodically to increase sprocket life. *Martin* Stock C-2000 series sprockets are furnished double duty only.

Sprockets for the C-2002 series chain with carrier rollers are cut with space cutters or standard hobs for the American Standard roller Chain of the same diameter. Each sprocket tooth meshes with these chains. Double-duty sprockets cannot be made for double pitch chain with Carrier Rollers.

**NOTE: For drives of 31 teeth or more we recommend using Standard sprockets with series C-2000 chains.**

**All altered double pitch sprockets requiring a keyway will be furnished with keyway on center line of tooth, unless otherwise specified.**

# Double Pitch All Steel Stock Sprockets

## 1-Inch Double-Pitch

### Conveyor or Drive Series — Standard Roller Double Pitch — 2040/C2040

No. Teeth Actual	Eff. No. Teeth	Outside Diameter	Pitch Diameter	Catalog Number	Type	Bore		Hub		Wt. Lbs. (Approx.)
						Stock	Rec. Max.	Diameter	Length Thru Bore	
11	5.5	2.000	1.852	2040B11	B	1/2	19/16	1 3/8★	7/8	.34
12	6.0	2.170	2.000	2040B12	B	1/2	19/16	1 1/16★	7/8	.44
13	6.5	2.330	2.152	2040B13	B	1/2	2 1/32	1 1/16★	7/8	.48
14	7.0	2.490	2.305	2040B14	B	1/2	1 1/32	1 1/16★	7/8	.60
15	7.5	2.650	2.458	2040B15	B	5/8	1 1/32	1 29/32	7/8	.66
16	8.0	2.810	2.613	2040B16	B	5/8	1 1/32	1 7/8	7/8	.76
17	8.5	2.980	2.768	2040B17	B	5/8	1 1/16	2 5/16	1	1.00
18	9.0	3.140	2.924	2040B18	B	5/8	1 15/32	2 1/32	1	1.16
19	9.5	3.300	3.080	2040B19	B	5/8	1 1/8	2 7/8	1	1.36
20	10.0	3.460	3.236	2040B20	B	5/8	1 1/4	2 29/64	1	1.54
21	10.5	3.620	3.392	2040B21	B	5/8	1 25/32	2 5/8	1	1.74
22	11.0	3.780	3.549	2040B22	B	5/8	1 1/2	2 7/8	1	1.92
23	11.5	3.940	3.706	2040B23	B	5/8	2	3	1	2.16
24	12.0	4.100	3.864	2040B24	B	5/8	2 1/4	3 1/4	1	2.44
25	12.5	4.260	4.021	2040B25	B	5/8	2 1/4	3 1/4	1	2.48
26	13.0	4.420	4.179	2040B26	B	5/8	2 1/4	3 1/4	1	2.60
28	14.0	4.740	4.494	2040B28	B	5/8	2 1/4	3 1/4	1	2.74
30	15.0	5.060	4.810	2040B30	B	5/8	2 1/4	3 1/4	1	2.92

★ Has recessed groove in hub for chain clearance.

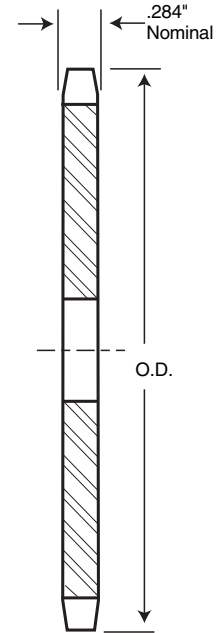

TYPE A

### Conveyor Series — Carrier Roller Double Pitch — 2042/C2042

No. Teeth Actual	Outside Diameter	Pitch Diameter	Catalog Number	Type	Bore		Hub		Wt. Lbs. (Approx.)	Type	Catalog Number	Stock Bore	Wt. Lbs. (Approx.)
					Stock	Rec. Max.	Dia.	Length Thru Bore					
8	3.010	2.613	2042B8	B	5/8	1 1/32	1 7/8	7/8	0.72	—	—	—	
9	3.350	2.924	2042B9	B	5/8	1 15/32	2 1/32	7/8	1.02	—	—	—	
10	3.680	3.236	2042B10	B	5/8	1 1/4	2 5/16	1	1.50	—	—	—	
11	4.000	3.549	2042B11	B	5/8	1 1/2	2 3/8	1	1.68	—	—	—	
12	4.330	3.864	2042B12	B	5/8	2 1/4	3 1/16	1	2.22	—	—	—	
13	4.660	4.179	2042B13	B	5/8	2 1/4	3 1/4	1	2.56	—	—	—	
14	4.980	4.494	2042B14	B	5/8	2 1/4	3 1/4	1	2.72	—	—	—	
15	5.300	4.810	2042B15	B	5/8	2 1/4	3 1/4	1	2.90	—	—	—	
16	5.630	5.126	2042B16	B	5/8	2 1/4	3 1/4	1	3.10	A	2042A16	19/32	1.38
17	5.950	5.442	2042B17	B	5/8	2 1/4	3 1/4	1	3.40	A	2042A17	19/32	1.66
18	6.270	5.759	2042B18	B	5/8	2 1/4	3 1/4	1	3.56	A	2042A18	19/32	1.88
19	6.590	6.076	2042B19	B	5/8	2 1/4	3 1/4	1	3.72	A	2042A19	19/32	2.06
20	6.910	6.392	2042B20	B	5/8	2 3/8	3 1/2	1 1/8	4.72	A	2042A20	23/32	2.40
21	7.240	6.710	2042B21	B	5/8	2 3/8	3 1/2	1 1/8	4.84	A	2042A21	23/32	2.62
22	7.560	7.027	2042B22	B	5/8	2 3/8	3 1/2	1 1/8	5.18	A	2042A22	23/32	2.88
23	7.880	7.344	2042B23	B	5/8	2 3/8	3 1/2	1 1/8	5.04	A	2042A23	23/32	3.14
24	8.200	7.661	2042B24	B	5/8	2 3/8	3 1/2	1 1/8	5.58	A	2042A24	23/32	3.22
25	8.520	7.979	2042B25	B	5/8	2 3/8	3 1/2	1 1/8	5.96	A	2042A25	23/32	3.50
26	8.840	8.296	2042B26	B	5/8	2 3/8	3 1/2	1 1/8	6.22	A	2042A26	23/32	3.74
28	9.480	8.931	2042B28	B	5/8	2 3/8	3 1/2	1 1/8	6.78	A	2042A28	23/32	4.76
30	10.110	9.567	2042B30	B	5/8	2 3/8	3 1/2	1 1/8	7.56	A	2042A30	23/32	5.08

★ Has recessed groove in hub for chain clearance.

Maximum bores shown will accommodate standard keyseat and setscrew over keyseat.  
Slightly larger bores are possible with no keyseat, shallow keyseat, or setscrew at angle to keyseat.

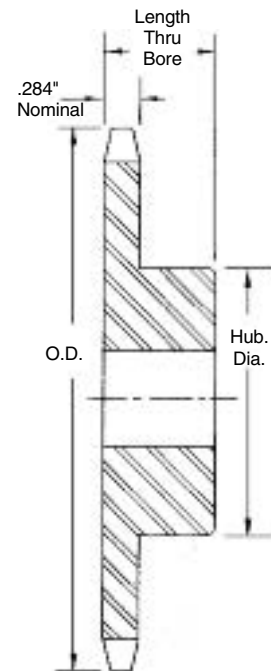

TYPE B

## 1¼-Inch Double-Pitch

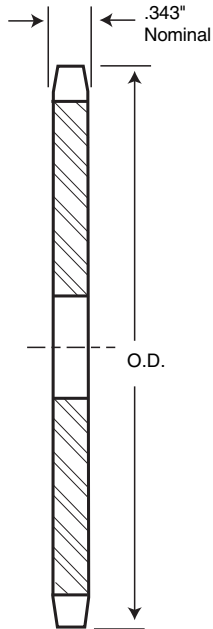

TYPE A

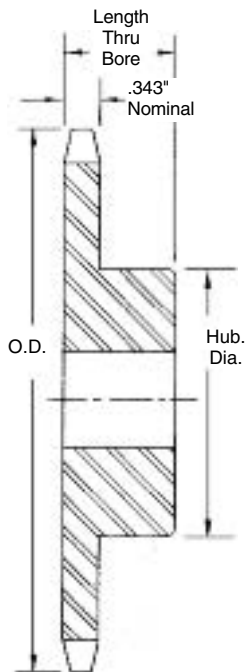

TYPE B

### Conveyor or Drive Series — Standard Roller Double Pitch — 2050/C2050

No. Teeth Actual	Eff. No. Teeth	Outside Diameter	Pitch Diameter	Catalog Number	Type	Bore		Hub		Wt. Lbs. (Approx.)	Type	Catalog Number	Stock Bore	Wt. Lbs. (Approx.)
						Stock	Rec. Max.	Dia.	Length Thru Bore					
11	5.5	2.500	2.315	2050B11	B	5/8	13/16	1 3/4*	1	0.62	—	—	—	
12	6.0	2.710	2.500	2050B12	B	5/8	1	1 5/8	1	0.80	—	—	—	
13	6.5	2.910	2.690	2050B13	B	5/8	1 1/2	1 7/8	1	0.82	—	—	—	
14	7.0	3.110	2.881	2050B14	B	5/8	1 1/2	1 5/8	1	1.00	—	—	—	
15	7.5	3.320	3.073	2050B15	B	5/8	1 13/32	2 5/32	1	1.22	—	—	—	
16	8.0	3.520	3.266	2050B16	B	5/8	1 13/32	2 3/4	1	1.44	—	—	—	
17	8.5	3.720	3.460	2050B17	B	5/8	1 1/2	2 1/2	1	1.68	—	—	—	
18	9.0	3.920	3.655	2050B18	B	5/8	1 25/32	2 5/8	1	1.94	—	—	—	
19	9.5	4.120	3.850	2050B19	B	3/4	1 31/32	2 5/8	1	2.24	—	—	—	
20	10.0	4.320	4.045	2050B20	B	3/4	2	3	1	2.30	—	—	—	
21	10.5	4.520	4.241	2050B21	B	3/4	2	3	1	2.40	—	—	—	
22	11.0	4.720	4.437	2050B22	B	3/4	2	3	1	2.54	—	—	—	
23	11.5	4.920	4.633	2050B23	B	3/4	2	3	1	2.66	—	—	—	
24	12.0	5.120	4.830	2050B24	B	3/4	2	3	1 1/4	3.30	A	2050A24	2 3/32	1.58
25	12.5	5.320	5.026	2050B25	B	3/4	2	3	1 1/4	3.42	A	2050A25	2 3/32	1.68
26	13.0	5.520	5.223	2050B26	B	3/4	2	3	1 1/4	3.62	A	2050A26	2 3/32	1.88
28	14.0	5.920	5.617	2050B28	B	3/4	2	3	1 1/4	3.78	A	2050A28	2 3/32	2.22
30	15.0	6.320	6.012	2050B30	B	3/4	2 1/4	3 1/4	1 1/4	4.58	A	2050A30	2 3/32	2.54

★ Has recessed groove in hub for chain clearance.

### Conveyor Series — Carrier Roller Double Pitch — 2052/C2052

No. Teeth Actual	Outside Diameter	Pitch Diameter	Catalog Number	Type	Bore		Hub		Wt. Lbs. (Approx.)	Type	Catalog Number	Stock Bore	Wt. Lbs. (Approx.)
					Stock	Rec. Max.	Dia.	Length Thru Bore					
8	3.770	3.266	2052B8	B	5/8	1 13/32	2 5/8	1	1.38	—	—	—	—
9	4.190	3.655	2052B9	B	5/8	1 25/32	2 5/8	1	1.92	—	—	—	—
10	4.600	4.045	2052B10	B	5/8	2	3	1	2.30	—	—	—	—
11	5.010	4.437	2052B11	B	5/8	2	3	1	2.54	—	—	—	—
12	5.420	4.830	2052B12	B	3/4	2	3	1 1/4	3.20	A	2052A12	2 3/32	1.58
13	5.820	5.223	2052B13	B	3/4	2	3	1 1/4	3.48	A	2052A13	2 3/32	1.82
14	6.230	5.617	2052B14	B	3/4	2	3	1 1/4	3.88	A	2052A14	2 3/32	2.28
15	6.630	6.012	2052B15	B	3/4	2 1/4	3 1/4	1 1/4	4.46	A	2052A15	2 3/32	2.46
16	7.030	6.407	2052B16	B	3/4	2 1/4	3 1/4	1 1/4	4.80	A	2052A16	2 3/32	2.88
17	7.440	6.803	2052B17	B	3/4	2 1/4	3 1/4	1 1/4	5.34	A	2052A17	2 3/32	3.28
18	7.840	7.198	2052B18	B	3/4	2 1/4	3 1/4	1 1/4	5.64	A	2052A18	2 3/32	3.64
19	8.240	7.595	2052B19	B	3/4	2 1/4	3 1/4	1 1/4	6.04	A	2052A19	2 3/32	4.12
20	8.640	7.991	2052B20	B	3/4	2 1/4	3 1/4	1 1/4	6.48	A	2052A20	2 3/32	4.72
21	9.040	8.387	2052B21	B	3/4	2 1/4	3 1/4	1 1/4	7.00	A	2052A21	2 3/32	5.08
22	9.440	8.783	2052B22	B	3/4	2 1/4	3 1/4	1 1/4	7.30	A	2052A22	2 3/32	5.20
23	9.850	9.180	2052B23	B	1	2 3/4	3 3/4	1 1/4	8.66	A	2052A23	1 5/16	5.84
24	10.250	9.577	2052B24	B	1 5/16	2 3/4	3 3/4	1 1/4	9.32	A	2052A24	1 5/16	6.70
25	10.650	9.973	2052B25	B	1 5/16	2 3/4	3 3/4	1 1/4	10.30	A	2052A25	1 5/16	7.54
26	11.050	10.370	2052B26	B	1 5/16	2 3/4	3 3/4	1 1/4	11.00	A	2052A26	1 5/16	8.24
28	11.840	11.164	2052B28	B	1 5/16	2 3/4	3 3/4	1 1/4	11.70	A	2052A28	1 5/16	8.70
30	12.640	11.958	2052B30	B	1 5/16	2 3/4	3 3/4	1 1/4	12.90	A	2052A30	1 5/16	9.92

★ Has recessed groove in hub for chain clearance.

Maximum bores shown will accommodate standard keyseat and setscrew over keyseat.  
Slightly larger bores are possible with no keyseat, shallow keyseat, or setscrew at angle to keyseat.

# Double Pitch All Steel Stock Sprockets

## 1½-Inch Double-Pitch

### Conveyor Series — Standard Roller Double Pitch — 2060/C2060

No. Teeth Actual	Eff. No. Teeth	Outside Diameter	Pitch Diameter	Catalog Number	Type	Bore		Hub		Wt. Lbs. (Approx.)	Type	Catalog Number	Stock Bore	Wt. Lbs. (Approx.)
						Stock	Rec. Max.	Dia.	Length Thru Bore					
11	5.5	3.000	2.773	2060B11	B	¾	1	2½/₁₆★	1¼	1.14	—	—	—	—
12	6.0	3.250	3.000	2060B12	B	¾	1¼	2½/₁₆★	1¼	1.46	—	—	—	—
13	6.5	3.490	3.228	2060B13	B	¾	1½/₁₆	2¾/₁₆	1¼	1.52	—	—	—	—
14	7.0	3.740	3.457	2060B14	B	¾	1¾/₁₆	2¾/₁₆	1¼	1.86	—	—	—	—
15	7.5	3.980	3.688	2060B15	B	¾	1¾	2¾/₁₆	1¼	2.24	—	—	—	—
16	8.0	4.220	3.920	2060B16	B	¾	1¾/₁₆	2¾/₁₆	1¼	2.64	—	—	—	—
17	8.5	4.460	4.152	2060B17	B	¾	2	3¾/₁₆	1¼	3.08	—	—	—	—
18	9.0	4.700	4.386	2060B18	B	¾	2¼/₁₆	3¾/₁₆	1¼	3.56	—	—	—	—
19	9.5	4.940	4.620	2060B19	B	¾	2½/₁₆	3¾	1¼	3.94	—	—	—	—
20	10.0	5.190	4.854	2060B20	B	¾	2¾/₁₆	3¾	1¼	4.50	—	—	—	—
21	10.5	5.430	5.089	2060B21	B	¾	2¾	4	1¼	5.02	—	—	—	—
22	11.0	5.670	5.324	2060B22	B	¾	2¾	4	1¼	5.26	—	—	—	—
23	11.5	5.910	5.560	2060B23	B	¾	2¾	4	1¼	5.54	—	—	—	—
24	12.0	6.150	5.796	2060B24	B	¾	2¾	4	1¼	5.90	A	2060A24	2¾/₁₆	3.02
25	12.5	6.390	6.032	2060B25	B	¾	2¾	4	1¼	6.08	A	2060A25	2¾/₁₆	3.36
26	13.0	6.630	6.268	2060B26	B	¾	2¾	4	1¼	6.36	A	2060A26	2¾/₁₆	3.58
28	14.0	7.110	6.741	2060B28	B	¾	2¾	4	1¼	7.02	A	2060A28	2¾/₁₆	4.12
30	15.0	7.590	7.215	2060B30	B	¾	2¾	4	1¼	7.54	A	2060A30	2¾/₁₆	4.88

★ Has recessed groove in hub for chain clearance.

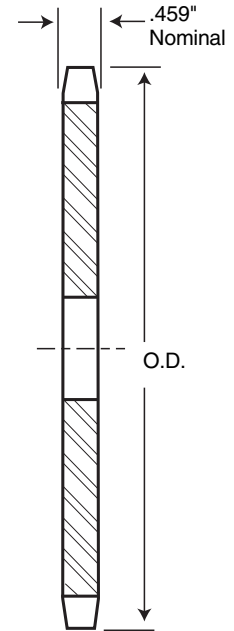

TYPE A

### Conveyor Series — Carrier Roller Double Pitch — 2062/C2062

No. Teeth Actual	Outside Diameter	Pitch Diameter	Catalog Number	Type	Bore		Hub		Wt. Lbs. (Approx.)	Type	Catalog Number	Stock Bore	Wt. Lbs. (Approx.)
					Stock	Rec. Max.	Dia.	Length Thru Bore					
8	4.520	3.920	2062B8	B	¾	1¾/₁₆	2¾/₁₆	1¼	2.60	—	—	—	—
9	5.020	4.386	2062B9	B	¾	2	3¾/₁₆	1¼	3.48	—	—	—	—
10	5.520	4.854	2062B10	B	¾	2¼/₁₆	3¾/₁₆	1¼	4.54	—	—	—	—
11	6.010	5.324	2062B11	B	¾	2¾/₁₆	4	1¼	5.20	—	—	—	—
12	6.500	5.796	2062B12	B	¾	2¾	4	1¼	5.70	A	2062A12	2¾/₁₆	2.98
13	6.990	6.268	2062B13	B	¾	2¾	4	1¼	6.28	A	2062A13	2¾/₁₆	3.60
14	7.470	6.741	2062B14	B	¾	2¾	4	1¼	6.82	A	2062A14	2¾/₁₆	4.02
15	7.960	7.215	2062B15	B	¾	2¾	4	1¼	7.48	A	2062A15	2¾/₁₆	4.76
16	8.440	7.689	2062B16	B	¾	2¾	4	1¼	8.18	A	2062A16	2¾/₁₆	5.70
17	8.920	8.163	2062B17	B	1	2¾	4	1¼	8.82	A	2062A17	1½/₁₆	6.16
18	9.410	8.638	2062B18	B	1	2¾	4	1¼	9.36	A	2062A18	1½/₁₆	6.96
19	9.890	9.113	2062B19	B	1	2¾	4¼	1¼	11.10	A	2062A19	1½/₁₆	8.00
20	10.370	9.589	2062B20	B	1½/₁₆	2¾	4¼	1¼	11.66	A	2062A20	1½/₁₆	8.46
21	10.850	10.064	2062B21	B	1½/₁₆	2¾	4¼	1¼	13.24	A	2062A21	1½/₁₆	8.93
22	11.330	10.540	2062B22	B	1½/₁₆	2¾	4¼	1¼	13.78	A	2062A22	1½/₁₆	10.74
23	11.810	11.016	2062B23	B	1½/₁₆	2¾	4¼	1¼	14.90	A	2062A23	1½/₁₆	11.64
24	12.290	11.492	2062B24	B	1½/₁₆	2¾	4¼	1¼	15.66	A	2062A24	1½/₁₆	12.64
25	12.770	11.968	2062B25	B	1½/₁₆	2¾	4¼	1¼	16.80	A	2062A25	1½/₁₆	13.78
26	13.250	12.444	2062B26	B	1½/₁₆	2¾	4¼	1¼	20.20	A	2062A26	1½/₁₆	15.00
28	14.210	13.397	2062B28	B	1	2¾	4¼	1¼	21.86	A	2062A28	1¼	17.32
30	15.170	14.350	2062B30	B	1¼	2¾	4¼	1¼	26.00	A	2062A30	1¼	19.50

★ Has recessed groove in hub for chain clearance.

Maximum bores shown will accommodate standard keyseat and setscrew over keyseat.  
Slightly larger bores are possible with no keyseat, shallow keyseat, or setscrew at angle to keyseat.

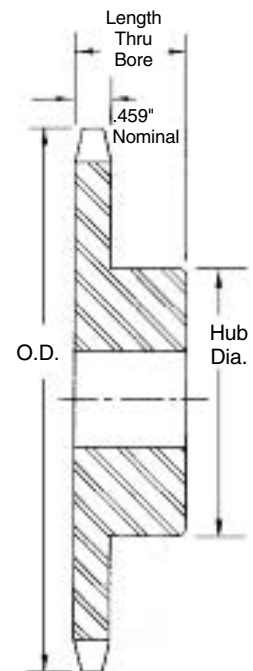

TYPE B

## 2-Inch Double-Pitch

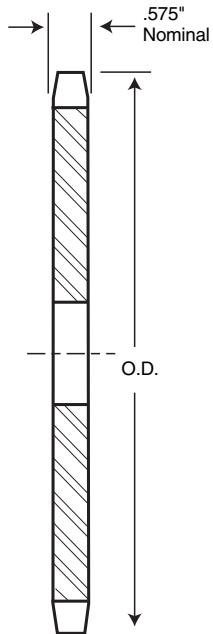

**TYPE A**

### Conveyor or Drive Series — Standard Roller Double Pitch — 2080/C2080

No. Teeth	Eff. No. Teeth	Outside Diameter	Pitch Diameter	Catalog Number	Type	Bore		Hub		Wt. Lbs. (Approx.)	Type	Catalog Number	Stock Bore	Wt. Lbs. (Approx.)
						Stock	Rec. Max.	Dia.	Length Thru Bore					
11	5.5	4.010	3.694	2080B11	B	1	1½	2¼*	1¼	2.5	—	—	—	
12	6.0	4.330	4.000	2080B12	B	1	1½	3¼*	1¼	3.2	—	—	—	
13	6.5	4.660	4.304	2080B13	B	1	1½	2½	1½	3.3	—	—	—	
14	7.0	4.980	4.610	2080B14	B	1	2½	3¼	1½	4.0	—	—	—	
15	7.5	5.300	4.917	2080B15	B	1	2½	3¼	1½	4.8	—	—	—	
16	8.0	5.630	5.226	2080B16	B	1	2½	3¼	1½	5.7	—	—	—	
17	8.5	5.950	5.536	2080B17	B	1	2½	4	1½	6.4	A	2080A17	1½	3.4
18	9.0	6.270	5.848	2080B18	B	1	2½	4¼	1½	7.4	A	2080A18	1½	3.8
19	9.5	6.590	6.160	2080B19	B	1	2½	4¼	1½	7.7	A	2080A19	1½	4.3
20	10.0	6.910	6.472	2080B20	B	1	2½	4¼	1½	8.3	A	2080A20	1½	4.8
21	10.5	7.230	6.785	2080B21	B	1	2½	4¼	1½	9.4	A	2080A21	1½	5.3
22	11.0	7.560	7.099	2080B22	B	1	2½	4¼	1½	10.0	A	2080A22	1½	5.8
23	11.5	7.880	7.413	2080B23	B	1	2½	4¼	1½	10.5	A	2080A23	1½	6.4
24	12.0	8.200	7.727	2080B24	B	1	2½	4¼	1½	11.1	A	2080A24	1½	7.1
25	12.5	8.520	8.042	2080B25	B	1	2½	4¼	1½	12.0	A	2080A25	1½	7.5
26	13.0	8.840	8.357	2080B26	B	1¼	3¼	4¼	2	14.8	A	2080A26	1¾	8.3
28	14.0	9.480	8.988	2080B28	B	1½	3¼	4¼	2	16.6	A	2080A28	1¾	9.2
30	15.0	10.110	9.620	2080B30	B	1½	3¼	4¼	2	17.8	A	2080A30	1¾	10.7

★ Has recessed groove in hub for chain clearance.

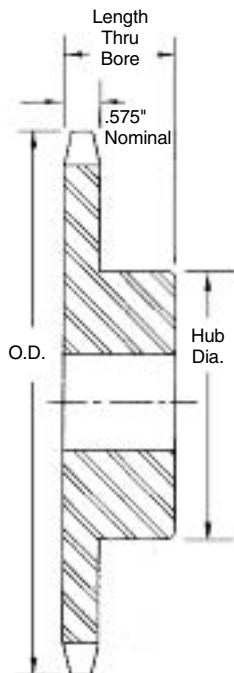

**TYPE B**

### Conveyor Series — Carrier Roller Double Pitch — 2082/C2082

No. Teeth	Outside Diameter	Pitch Diameter	Catalog Number	Type	Bore		Hub		Wt. Lbs. (Approx.)	Type	Catalog Number	Stock Bore	Wt. Lbs. (Approx.)
					Stock	Rec. Max.	Dia.	Length Thru Bore					
8	6.030	5.226	2082B8	B	1	2½	3¼	1¼	6.4	—	—	—	
9	6.700	5.848	2082B9	B	1	2½	4¼	1¼	8.2	—	—	—	
10	7.360	6.472	2082B10	B	1	2½	4¼	1¼	9.2	—	—	—	
11	8.010	7.099	2082B11	B	1	2½	4¼	1¼	10.1	A	2082A11	1½	5.7
12	8.660	7.727	2082B12	B	1	2½	4¼	1¼	11.2	A	2082A12	1½	6.8
13	9.310	8.357	2082B13	B	1¼	3¼	4¼	2	15.0	A	2082A13	1¾	7.7
14	9.960	8.988	2082B14	B	1¼	3¼	4¼	2	15.8	A	2082A14	1¾	9.1
15	10.610	9.620	2082B15	B	1½	3¼	4¼	2	17.8	A	2082A15	1¾	10.7
16	11.250	10.252	2082B16	B	1½	3¼	4¼	2	19.3	A	2082A16	1¾	12.4
17	11.900	10.885	2082B17	B	1½	3¼	4¼	2	21.4	A	2082A17	1¾	14.1
18	12.540	11.518	2082B18	B	1½	3¼	4¼	2	22.9	A	2082A18	1¾	15.4
19	13.190	12.151	2082B19	B	1½	3¼	4¼	2	24.4	A	2082A19	1¾	18.0
20	13.830	12.785	2082B20	B	1½	3¼	4¼	2	26.7	A	2082A20	1¾	19.2
21	14.470	13.419	2082B21	B	1¼	3¼	4¼	2	28.4	A	2082A21	1¼	20.8
22	15.110	14.053	2082B22	B	1¼	3¼	4¼	2	30.8	A	2082A22	1¼	23.7
23	15.750	14.688	2082B23	B	1¼	3¼	4¼	2	32.2	A	2082A23	1¼	24.9
24	16.390	15.323	2082B24	B	1¼	3¼	4¼	2	34.9	A	2082A24	1¼	27.6
25	17.030	15.958	2082B25	B	1¼	3¼	4¼	2	37.8	A	2082A25	1¼	30.2
26	17.670	16.593	2082B26	B	1¼	3¼	5¼	2	41.5	A	2082A26	1¼	32.8
28	18.950	17.863	2082B28	B	1¼	3¼	5¼	2	47.7	A	2082A28	1¼	38.6
30	20.230	19.134	2082B30	B	1¼	3¼	5¼	2	54.5	A	2082A30	1¼	43.8

★ Has recessed groove in hub for chain clearance.

Maximum bores shown will accommodate standard keyseat and setscrew over keyseat.  
Slightly larger bores are possible with no keyseat, shallow keyseat, or setscrew at angle to keyseat.

# No. 25

## 1/4" Pitch

# All Steel Stock Sprockets

# Martin

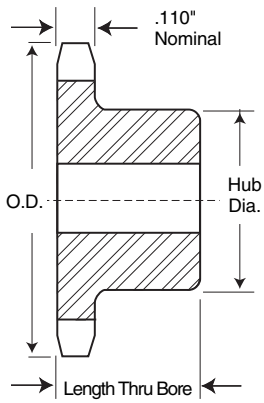

**TYPE B**



### Alteration Charges

See current discount sheet for alteration charges.

## Single - Type B

## Single - Type A

No. Teeth	Catalog Number	Outside Diameter	Type	Bore (inches)		Hub (inches)		Weight Lbs. (Approx.)	Type	Catalog Number	Stock Bore	Weight Lbs. (Approx.)
				Stock	Rec. Max.	Diameter	Length Thru Bore					
9	25B9	0.837	B	1/4	1/4	7/16	1/2	0.03	-	-	-	-
10	25B10	0.919	B	1/4	1/4	1/2	1/2	0.03	-	-	-	-
11	25B11	1.002	B	1/4	5/16	7/16	1/2	0.04	-	-	-	-
12	25B12	1.083	B	1/4	3/8	5/8	1/2	0.06	-	-	-	-
13	25B13	1.167	B	1/4	7/16	23/32	1/2	0.07	-	-	-	-
14	25B14	1.246	B	1/4	1/2	13/16	1/2	0.08	-	-	-	-
15	25B15	1.326	B	1/4	9/16	57/64	1/2	0.10	-	-	-	-
16	25B16	1.407	B	1/4	9/16	31/32	1/2	0.12	-	-	-	-
17	25B17	1.487	B	1/4	5/8	13/32	1/2	0.14	-	-	-	-
18	25B18	1.568	B	1/4	3/4	13/16	1/2	0.16	A	25A18	1/4	0.04
19	25B19	1.648	B	1/4	13/16	17/32	1/2	0.19	A	25A19	1/4	0.04
20	25B20	1.729	B	1/4	7/8	17/32	5/8	0.25	A	25A20	1/4	0.04
21	25B21	1.809	B	1/4	7/8	13/8	5/8	0.28	A	25A21	3/8	0.04
22	25B22	1.889	B	1/4	15/16	17/16	5/8	0.31	A	25A22	3/8	0.06
23	25B23	1.969	B	1/4	1	17/8	5/8	0.32	A	25A23	3/8	0.06
24	25B24	2.049	B	3/8	1	17/8	5/8	0.33	A	25A24	3/8	0.08
25	25B25	2.129	B	3/8	1	17/8	5/8	0.34	A	25A25	3/8	0.08
26	25B26	2.209	B	3/8	1	17/8	5/8	0.35	A	25A26	3/8	0.09
28	25B28	2.369	B	3/8	1	17/8	5/8	0.36	A	25A28	3/8	0.10
30	25B30	2.529	B	3/8	1	17/8	5/8	0.38	A	25A30	3/8	0.12
32	25B32	2.688	B	3/8	1	17/8	5/8	0.40	A	25A32	3/8	0.14
35	-	2.928	-	-	-	-	-	-	A	25A35	3/8	0.16
36	25B36	3.008	B	3/8	1	17/8	3/4	0.50	A	25A36	3/8	0.18
40	25B40	3.327	B	1/2	1 1/8	2	3/4	0.53	A	25A40	1/2	0.20
42	-	3.486	-	-	-	-	-	-	A	25A42	1/2	0.24
45	25B45	3.725	B	1/2	1 1/8	2	3/4	0.56	A	25A45	1/2	0.25
48	25B48	3.964	B	1/2	1 1/8	2	3/4	0.56	A	25A48	1/2	0.32
54	25B54	4.442	B	1/2	1 1/8	2	3/4	1.00	A	25A54	1/2	0.38
60	25B60	4.920	B	1/2	1 1/8	2	3/4	1.10	A	25A60	1/2	0.54
70	25B70	5.717	B	1/2	1 1/8	2	3/4	1.25	-	-	-	-
72	25B72	5.876	B	1/2	1 1/8	2	3/4	1.30	A	25A72	1/2	0.74

Maximum bores shown will accommodate standard keyseat and setscrew over keyseat. Slightly larger bores are possible with no keyseat, shallow keyseat, or setscrew at angle to keyseat.



### Alteration Charges

See current discount sheet for alteration charges.

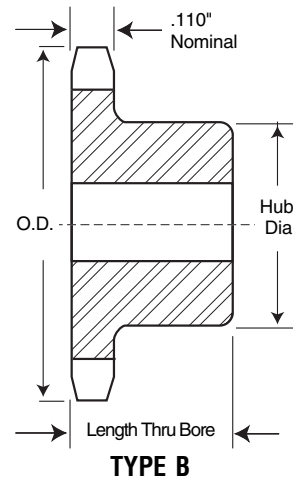

**STAINLESS STEEL**

### Single - Type B — Stainless

No. Teeth	Catalog Number	Outside Diameter	Type	Bore (inches)		Hub (inches)		Weight Lbs. (Approx.)
				Stock	Rec. Max.	Diameter	Length Thru	
9	25B9SS	0.837	B	1/4	1/4	7/16	1/2	0.03
10	25B10SS	0.919	B	1/4	1/4	1/2	1/2	0.03
11	25B11SS	1.001	B	1/4	5/16	9/16	1/2	0.03
12	25B12SS	1.083	B	1/4	3/8	5/8	1/2	0.06
13	25B13SS	1.164	B	1/4	7/16	23/32	1/2	0.07
14	25B14SS	1.245	B	1/4	9/16	13/16	1/2	0.08
15	25B15SS	1.326	B	1/4	1/2	7/8	1/2	0.10
16	25B16SS	1.407	B	1/4	9/16	31/32	1/2	0.12
17	25B17SS	1.487	B	1/4	5/8	1 1/32	1/2	0.14
18	25B18SS	1.568	B	1/4	3/4	1 1/8	1/2	0.16
19	25B19SS	1.648	B	1/4	13/16	1 1/32	1/2	0.19
20	25B20SS	1.728	B	1/4	7/8	1 1/32	5/8	0.25
21	25B21SS	1.809	B	1/4	1 1/8	1 3/8	5/8	0.28
22	25B22SS	1.889	B	1/4	15/16	1 1/16	5/8	0.31
23	25B23SS	1.969	B	1/4	1	1 1/2	5/8	0.32
24	25B24SS	2.049	B	3/8	1	1 1/2	5/8	0.33
25	25B25SS	2.129	B	3/8	1	1 1/2	5/8	0.34
26	25B26SS	2.209	B	3/8	1	1 1/2	5/8	0.35
28	25B28SS	2.369	B	3/8	1	1 1/2	5/8	0.36
30	25B30SS	2.529	B	3/8	1	1 1/2	5/8	0.38
32	25B32SS	2.688	B	3/8	1	1 1/2	5/8	0.40
35	25B35SS	2.928	B	3/8	1	1 1/2	3/4	0.48
36	25B36SS	3.008	B	3/8	1	1 1/2	3/4	0.50
40	25B40SS	3.327	B	1/2	1 1/8	2	3/4	0.53
45	25B45SS	3.725	B	1/2	1 1/8	2	3/4	0.56
60	25B60SS	4.920	B	1/2	1 3/8	2	3/4	1.10

Maximum bores shown will accommodate standard keyseat and setscrew over keyseat. Slightly larger bores are possible with no keyseat, shallow keyseat, or setscrew at angle to keyseat.

Sprockets altered at factory (rebored with key way and setscrew added) will be supplied with stainless setscrew.

# No. 35

## 3/8" Pitch

# All Steel Stock Sprockets

# Martin

### Single - Type BS — 2 Setscrews — Bored-To-Size

No. Teeth	Catalog Number	Outside Diameter	Length Thru Bore	Weight Lbs. (Approx.)	Stock Finished Bores Includes Keyway and 2 Setscrews
9	35BS9	1.260	3/4	0.10	★3/8
10	35BS10	1.380	3/4	0.11	★3/8 — ★1/2 — † 3/8
11	35BS11	1.500	3/4	0.15	★3/8 — ★1/2 — † 3/8 — † 3/8
12	35BS12	1.630	3/4	0.18	— ★1/2 — 3/8 — † 3/8
13	35BS13	1.750	3/4	0.20	— ★1/2 — 3/8 — 3/8
14	35BS14	1.870	3/4	0.22	— ★1/2 — 3/8 — 3/8
15	35BS15	1.990	3/4	0.24	— ★1/2 — 3/8 — 3/8 — 3/8 — 1
16	35BS16	2.110	3/4	0.29	— ★1/2 — 3/8 — 3/8 — 3/8 — 1
17	35BS17	2.230	3/4	0.36	— ★1/2 — 3/8 — 3/8 — 3/8 — 1
18	35BS18	2.350	3/4	0.39	— ★1/2 — 3/8 — 3/8 — 3/8 — 1
19	35BS19	2.470	3/4	0.44	— ★1/2 — 3/8 — 3/8 — 3/8 — 1
20	35BS20	2.590	3/4	0.51	— ★1/2 — 3/8 — 3/8 — 3/8 — 1
21	35BS21	2.710	3/4	0.75	— ★1/2 — 3/8 — 3/8 — 3/8 — 1
22	35BS22	2.830	3/4	0.78	— ★1/2 — 3/8 — 3/8 — 3/8 — 1
23	35BS23	2.950	3/4	0.78	— ★1/2 — 3/8 — 3/8 — 3/8 — 1
24	35BS24	3.070	3/4	0.79	— ★1/2 — 3/8 — 3/8 — 3/8 — 1
25	35BS25	3.190	3/4	0.80	— ★1/2 — 3/8 — 3/8 — 3/8 — 1
26	35BS26	3.310	3/4	0.84	— 3/8 — 3/8 — 3/8 — 1 — 1 1/8 — 1 1/8 — 1 1/8
27	35BS27	3.430	3/4	0.88	— 3/8 — 3/8 — 3/8 — 1 — 1 1/8 — 1 1/8 — 1 1/8
28	35BS28	3.550	3/4	0.86	— 3/8 — 3/8 — 3/8 — 1 — 1 1/8 — 1 1/8 — 1 1/8
30	35BS30	3.790	3/4	0.96	— 3/8 — 3/8 — 3/8 — 1 — 1 1/8 — 1 1/8 — 1 1/8
32	35BS32	4.030	3/4	1.14	— 3/8 — 3/8 — 3/8 — 1 — 1 1/8 — 1 1/8 — 1 1/8
35	35BS35	4.390	3/4	1.38	— 3/8 — 3/8 — 3/8 — 1 — 1 1/8 — 1 1/8 — 1 1/8
36	35BS36	4.510	3/4	1.41	— 3/8 — 3/8 — 3/8 — 1 — 1 1/8 — 1 1/8 — 1 1/8
40	35BS40	4.990	1	1.56	— 3/8 — 3/8 — 3/8 — 1 — 1 1/8 — 1 1/8 — 1 1/8
42	35BS42	5.230	1	1.64	— 3/8 — 3/8 — 3/8 — 1 — 1 1/8 — 1 1/8 — 1 1/8
45	35BS45	5.590	1	1.74	— 3/8 — 3/8 — 3/8 — 1 — 1 1/8 — 1 1/8 — 1 1/8
48	35BS48	5.950	1	1.86	— 3/8 — 3/8 — 3/8 — 1 — 1 1/8 — 1 1/8 — 1 1/8
54	35BS54	6.660	1	1.98	— 3/8 — 3/8 — 3/8 — 1 — 1 1/8 — 1 1/8 — 1 1/8
60	35BS60	7.380	1	2.34	— 3/8 — 3/8 — 3/8 — 1 — 1 1/8 — 1 1/8 — 1 1/8
70	35BS70	8.580	1	3.14	— 3/8 — 3/8 — 3/8 — 1 — 1 1/8 — 1 1/8 — 1 1/8
72	35BS72	8.810	1	3.30	— 3/8 — 3/8 — 3/8 — 1 — 1 1/8 — 1 1/8 — 1 1/8
80	35BS80	9.770	1	3.94	— 3/8 — 3/8 — 3/8 — 1 — 1 1/8 — 1 1/8 — 1 1/8
84	35BS84	10.250	1	4.26	— 3/8 — 3/8 — 3/8 — 1 — 1 1/8 — 1 1/8 — 1 1/8
96	35BS96	11.680	1	5.22	— 3/8 — 3/8 — 3/8 — 1 — 1 1/8 — 1 1/8 — 1 1/8
112	35BS112	13.590	1	6.50	— 3/8 — 3/8 — 3/8 — 1 — 1 1/8 — 1 1/8 — 1 1/8

★ Indicates no keyway. (2) 1/4" setscrews only in 1/2" & 3/4" bore.

† Keyway with Setscrew at 90°.

Hub diameters vary to suit different bore sizes.

NOTE: KEYWAY IS ON CENTER LINE OF TOOTH.

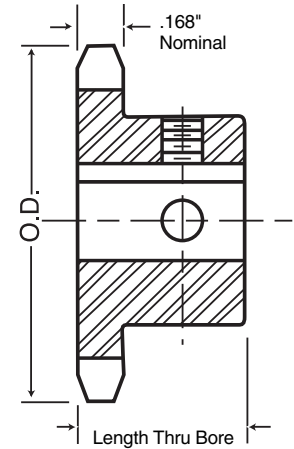

**TYPE BS**



**BORED-TO-SIZE**

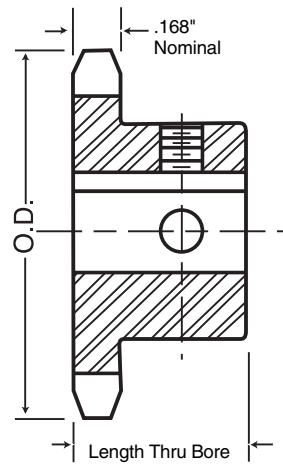

TYPE BS



BORED-TO-SIZE



### No. 35-Hardened Teeth — 2 Setscrews — Bored-To-Size

No. Teeth	Catalog Number	Outside Diameter	Length Thru Bore	Weight Libs. (Approx.)	Stock Finished Bores Includes Keyway and 2 Setscrews
9	35BS9HT	1.260	3/4	0.10	*3/8
10	35BS10HT	1.380	3/4	0.11	*3/8 — *1/2 — † 5/8
11	35BS11HT	1.500	3/4	0.15	*3/8 — *1/2 — † 5/8 — † 3/4
12	35BS12HT	1.630	3/4	0.18	— *1/2 — 5/8 — † 3/4
13	35BS13HT	1.750	3/4	0.20	— *1/2 — 5/8 — 3/4
14	35BS14HT	1.870	3/4	0.22	— *1/2 — 5/8 — 3/4
15	35BS15HT	1.990	3/4	0.24	— *1/2 — 5/8 — 3/4 — 7/8 — 1
16	35BS16HT	2.110	3/4	0.29	— *1/2 — 5/8 — 3/4 — 7/8 — 1
17	35BS17HT	2.230	3/4	0.36	— *1/2 — 5/8 — 3/4 — 7/8 — 1
18	35BS18HT	2.350	3/4	0.39	— *1/2 — 5/8 — 3/4 — 7/8 — 1
19	35BS19HT	2.470	3/4	0.44	5/8 — 3/4 — — 1
20	35BS20HT	2.590	3/4	0.51	5/8 — 3/4 — — 1
21	35BS21HT	2.710	7/8	0.75	5/8 — 3/4 — — 1
22	35BS22HT	2.830	7/8	0.76	5/8 — 3/4 — — 1
23	35BS23HT	2.950	7/8	0.78	5/8 — 3/4 — — 1
24	35BS24HT	3.070	7/8	0.79	5/8 — 3/4 — — 1
25	35BS25HT	3.190	7/8	0.80	5/8 — 3/4 — — 1
26	35BS26HT	3.310	7/8	0.84	5/8 — 3/4 — — 1
28	35BS28HT	3.550	7/8	0.88	5/8 — 3/4 — — 1
30	35BS30HT	3.790	7/8	0.96	5/8 — 3/4 — — 1

\* Indicates no keyway. (2) 1/4" setscrews only in 1/2" & 3/8" bore at 90°.

† Keyway with Setscrew at 90° & 180°.

Hub diameters vary to suit different bore sizes.

NOTE: KEYWAY IS ON CENTER LINE OF TOOTH.

*Martin* stock hardened teeth sprockets afford longer chain and sprocket life. Hardened teeth on the smaller sprocket of a roller chain drive are recommended if the drive ratio is four to one or greater or if the smaller sprocket has 24 teeth or less and is running at a speed of over 600 R.P.M.

# No. 35

## 3/8" Pitch

# Stainless Steel Stock Sprockets

# Martin



STAINLESS STEEL

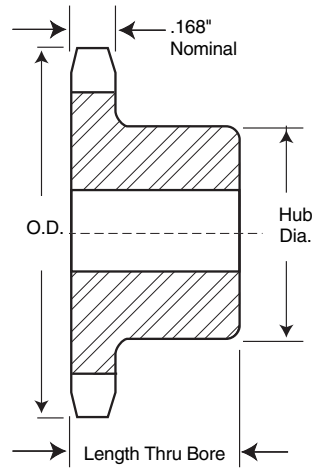

TYPE B

### Alteration Charges

See current discount sheet for alteration charges.

## Single - Type B — Stainless

## Single - Type A

No. Teeth	Catalog Number	Outside Diameter	Type	Bore (inches)		Hub (inches)		Weight Lbs. (Approx.)	Type	Catalog Number	Stock Bore	Weight Lbs. (Approx.)
				Stock	Rec. Max.	Diameter	Length Thru					
9	35B9SS	1.260	B	3/8	3/8	27/32★	3/4	0.10				
10	35B10SS	1.380	B	3/8	3/8	31/32★	3/4	0.15				
11	35B11SS	1.500	B	3/8	3/8	1 1/16★	3/4	0.20				
12	35B12SS	1.630	B	1/2	3/8	1 1/32★	3/4	0.22				
13	35B13SS	1.750	B	1/2	3/4	1 1/4★	3/4	0.25				
14	35B14SS	1.870	B	1/2	7/8	1 1/4	3/4	0.26				
15	35B15SS	1.990	B	1/2	7/8	1 11/32	3/4	0.30				
16	35B16SS	2.110	B	1/2	15/16	1 19/32	3/4	0.40				
17	35B17SS	2.230	B	1/2	1 1/16	1 19/32	3/4	0.43				
18	35B18SS	2.350	B	1/2	1 1/16	1 29/32	3/4	0.50				
19	35B19SS	2.470	B	1/2	1 1/4	1 29/32	3/4	0.56				
20	35B20SS	2.590	B	1/2	1 1/16	1 19/16	3/4	0.68				
21	35B21SS	2.710	B	1/2	1 3/8	2	7/8	0.80				
22	35B22SS	2.830	B	1/2	1 3/8	2	7/8	0.82				
23	35B23SS	2.950	B	1/2	1 3/8	2	7/8	0.87				
24	35B24SS	3.070	B	1/2	1 3/8	2	7/8	0.89				
25	35B25SS	3.190	B	1/2	1 3/8	2	7/8	0.91				
26	35B26SS	3.310	B	1/2	1 3/8	2	7/8	0.93				
28	35B28SS	3.550	B	1/2	1 3/8	2	7/8	1.00				
30	35B30SS	3.790	B	1/2	1 3/8	2	7/8	1.06				
32	35B32SS	4.032	B	1/2	1 3/8	2	7/8	1.24				
35	35B35SS	4.390	B	3/4	1 1/2	2 1/4	7/8	1.56				
36	35B36SS	4.551	B	3/4	1 1/2	2 1/4	7/8	1.60				
40	35B40SS	4.990	B	3/4	1 1/2	2 1/4	1	1.70	A	35A40SS	19/32	1.04
45	35B45SS	5.590	B	3/4	1 1/2	2 1/4	1	2.18	A	35A45SS	19/32	1.26
60	35B60SS	7.380	B	3/4	1 1/2	2 1/4	1	3.00	A	35A60SS	27/32	2.10

★ Has recessed groove in hub for chain clearance.

Maximum bores shown will accommodate standard keyseat and setscrew over keyseat. Slightly larger bores are possible with no keyseat, shallow keyseat, or setscrew at angle to keyseat.

Sprockets altered at factory (rebored with keyway and setscrew added) will be supplied with stainless setscrew.

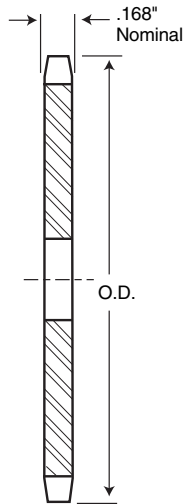

TYPE A



TYPE A

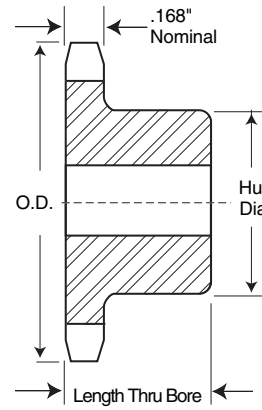

TYPE B



TYPE B

### Alteration Charges

See current discount sheet for alteration charges.

### Single - Type B — Steel

### Single - Type A

No. Teeth	Catalog Number	Outside Diameter	Type	Bore (inches)		Hub (inches)		Weight Lbs. (Approx.)	Type	Catalog Number	Stock Bore	Weight Lbs. (Approx.)
				Stock	Rec. Max.	Diameter	Length Thru					
8	35B8	1.130	B	3/8	3/8	3/4★	3/8	0.07				
9	35B9	1.260	B	3/8	3/8	27/32★	3/8	0.09				
10	35B10	1.380	B	3/8	9/16	31/32★	3/8	0.14				
11	35B11	1.500	B	3/8	9/16	1 1/16★	3/8	0.17				
12	35B12	1.630	B	1/2	9/16	1 1/32★	3/8	0.20				
13	35B13	1.750	B	1/2	1 1/16	1 1/4★	3/8	0.23				
14	35B14	1.870	B	1/2	7/8	1 1/2	3/8	0.25				
15	35B15	1.990	B	1/2	7/8	1 11/32	3/8	0.29	A	35A15	1/2	0.10
16	35B16	2.110	B	1/2	7/8	1 1/2	3/8	0.35	A	35A16	1/2	0.12
17	35B17	2.230	B	1/2	1 1/16	1 13/32	3/8	0.42	A	35A17	1/2	0.12
18	35B18	2.350	B	1/2	1 1/8	1 23/32	3/8	0.48	A	35A18	1/2	0.14
19	35B19	2.470	B	1/2	1 1/4	1 27/32	3/8	0.54	A	35A19	1/2	0.16
20	35B20	2.590	B	1/2	1 1/8	1 11/16	3/8	0.59	A	35A20	1/2	0.20
21	35B21	2.710	B	1/2	1 3/8	2	3/8	0.80	A	35A21	1/2	0.20
22	35B22	2.830	B	1/2	1 3/8	2	3/8	0.80	A	35A22	1/2	0.22
23	35B23	2.950	B	1/2	1 3/8	2	3/8	0.82	A	35A23	1/2	0.24
24	35B24	3.070	B	1/2	1 3/8	2	3/8	0.88	A	35A24	1/2	0.26
25	35B25	3.190	B	1/2	1 3/8	2	3/8	0.88	A	35A25	1/2	0.28
26	35B26	3.310	B	1/2	1 3/8	2	3/8	0.90	A	35A26	1/2	0.28
27	35B27	3.430	B	1/2	1 3/8	2	3/8	0.94	A	35A27	1/2	0.34
28	35B28	3.550	B	1/2	1 3/8	2	3/8	0.94	A	35A28	1/2	0.34
30	35B30	3.790	B	1/2	1 3/8	2	3/8	1.02	A	35A30	1/2	0.46
32	35B32	4.030	B	1/2	1 3/8	2	3/8	1.24	A	35A32	3/8	0.46
35	35B35	4.390	B	3/4	1 1/2	2 1/4	3/8	1.50	A	35A35	3/8	0.60
36	35B36	4.510	B	3/4	1 1/2	2 1/4	3/8	1.56	A	35A36	3/8	0.62
40	35B40	4.990	B	3/4	1 1/2	2 1/4	1	1.62	A	35A40	19/32	0.70
42	35B42	5.230	B	3/4	1 1/2	2 1/4	1	1.68	A	35A42	19/32	0.78
45	35B45	5.590	B	3/4	1 1/2	2 1/4	1	1.78	A	35A45	19/32	0.88
48	35B48	5.950	B	3/4	1 1/2	2 1/4	1	1.88	A	35A48	19/32	1.21
54	35B54	6.660	B	3/4	1 1/2	2 1/4	1	2.20	A	35A54	23/32	1.32
60	35B60	7.380	B	3/4	1 1/2	2 1/4	1	2.48	A	35A60	23/32	1.66
70	35B70	8.580	B	3/4	1 1/2	2 1/4	1	3.12	A	35A70	23/32	2.30
72	35B72	8.810	B	3/4	1 1/2	2 1/4	1	3.42	A	35A72	23/32	2.56
80	35B80	9.770	B	3/4	1 1/2	2 1/4	1	3.82	A	35A80	23/32	3.16
84	35B84	10.250	B	3/4	1 1/2	2 1/4	1	4.24	A	35A84	23/32	3.26
96	35B96	11.680	B	3/4	1 1/2	2 1/4	1	5.16	A	35A96	23/32	4.64
112	35B112	13.590	B	3/4	1 1/2	2 1/4	1	6.70	A	35A112	23/32	5.05

★ Has recessed groove in hub for chain clearance.

Maximum bores shown will accommodate standard keyseat and setscrew over keyseat. Slightly larger bores are possible with no keyseat, shallow keyseat, or setscrew at angle to keyseat.

# No. 35

## 3/8" Pitch

# All Steel Stock Sprockets

### Single - Taper Bushed

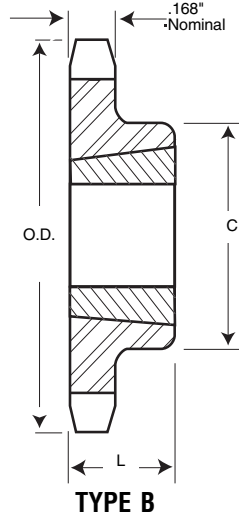

### Single - Taper Bushed

No. Teeth	Catalog Number	Bushing	Diameter		Max. Bore	Dimensions		Type	Weight Lbs. (Approx.)	
			Outside Diameter	Pitch Diameter		L	C		Rim Only	Bushing Only
18	35BTB18	1008	2.352	2.159	1	7/8	1 1/8★	B	0.4	0.3
19	35BTB19	1008	2.472	2.278	1	7/8	1 1/16	B	0.5	0.3
20	35BTB20	1008	2.593	2.397	1	7/8	1 1/16	B	0.6	0.3
21	35BTB21	1008	2.713	2.516	1	7/8	2 1/16	B	0.7	0.3
22	35BTB22	1210	2.883	2.635	1 1/4	1	2 3/8★	B	0.8	0.6
23	35BTB23	1210	2.954	2.754	1 1/4	1	2 7/16	B	0.9	0.6
24	35BTB24	1210	3.074	2.873	1 1/4	1	2 7/16	B	0.9	0.6
25	35BTB25	1210	3.194	2.992	1 1/4	1	2 7/16	B	1.2	0.6
26	35BTB26	1610	3.314	3.111	1 1/2	1	2 7/8★	B	1.1	0.9
28	35BTB28	1610	3.553	3.349	1 1/2	1	2 7/8	B	1.2	0.9
30	35BTB30	1610	3.793	3.588	1 1/2	1	3 1/8	B	1.2	0.9
32	35BTB32	1610	4.032	3.826	1 1/2	1	3 1/8	B	1.3	0.9
35	35BTB35	1610	4.392	4.183	1 1/2	1	3 3/8	B	1.4	0.9
36	35BTB36	1610	4.511	4.303	1 1/2	1	3 3/8	B	1.4	0.9
40	35BTB40	1610	4.990	4.786	1 1/2	1	3 3/8	B	1.9	0.9
42	35BTB42	1610	5.229	5.018	1 1/2	1	3 3/8	B	2.0	0.9
45	35BTB45	1610	5.588	5.376	1 1/2	1	3 3/8	B	2.1	0.9
48	35BTB48	1610	5.946	5.734	1 1/2	1	3 3/8	B	2.3	0.9
54	35BTB54	1610	6.663	6.449	1 1/2	1	3 3/8	B	2.6	0.9
60	35BTB60	1610	7.380	7.165	1 1/2	1	3 3/8	B	3.0	0.9
70	35BTB70	1610	8.575	8.358	1 1/2	1	3 3/8	B	3.7	0.9
72	35BTB72	1610	8.814	8.597	1 1/2	1	3 3/8	B	3.9	0.9
80	35BTB80	1610	9.770	9.552	1 1/2	1	3 3/8	B	4.5	0.9
84	35BTB84	1610	10.247	10.029	1 1/2	1	3 3/8	B	4.9	0.9
96	35BTB96	1610	11.680	11.461	1 1/2	1	3 3/8	B	6.0	0.9
112	35BTB112	1610	13.590	13.371	1 1/2	1	3 3/8	B	7.8	0.9

★ Has recessed groove in hub for chain clearance.

# Martin

## All Steel Stock Sprockets

# No. 35

## 3/8" Pitch

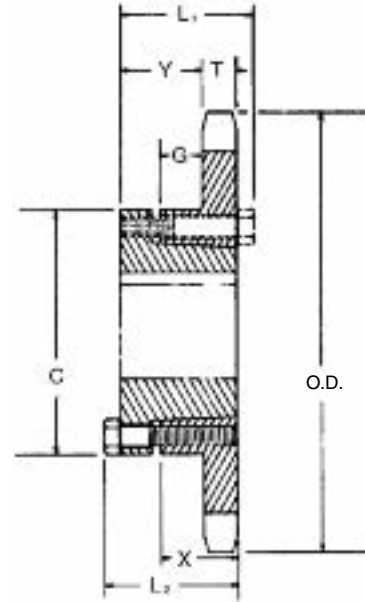

QD — TYPE B

### Single - Type QD

No. Teeth	Catalog Number	Bushing	Diameters		Type	Max. Bore	Dimensions							Weight Lbs. (Approx.)	
			Outside Diameter	Pitch Diameter			L <sub>1</sub>	L <sub>2</sub>	C	Y	G	X	T	With Hub	Rim Only
19	35JA19	JA	2.470	2.278	B	1 1/4	1 1/8	1 1/8	2 1/16	5/64	29/64	5/8	0.168	1.18	0.28
20	35JA20	JA	2.590	2.397	B	1 1/4	1 1/8	1 1/8	2 1/16	5/64	29/64	5/8	0.168	1.22	0.32
21	35JA21	JA	2.710	2.516	B	1 1/4	1 1/8	1 1/8	2 1/16	5/64	29/64	5/8	0.168	1.24	0.34
22	35JA22	JA	2.830	2.635	B	1 1/4	1 1/8	1 1/8	2 1/16	5/64	29/64	5/8	0.168	1.26	0.36
23	35JA23	JA	2.950	2.754	B	1 1/4	1 1/8	1 1/8	2 1/16	5/64	29/64	5/8	0.168	1.28	0.38
24	35JA24	JA	3.070	3.873	B	1 1/4	1 1/8	1 1/8	2 1/16	5/64	29/64	5/8	0.168	1.30	0.40
25	35JA25	JA	3.190	2.992	B	1 1/4	1 1/8	1 1/8	2 1/16	5/64	29/64	5/8	0.168	1.34	0.44
26	35JA26	JA	3.310	3.111	B	1 1/4	1 1/8	1 1/8	2 1/16	5/64	29/64	5/8	0.168	1.36	0.46
27	35JA27	JA	3.430	3.230	B	1 1/4	1 1/8	1 1/8	2 1/16	5/64	29/64	5/8	0.168	1.38	0.48
28	35JA28	JA	3.550	3.349	B	1 1/4	1 1/8	1 1/8	2 1/16	5/64	29/64	5/8	0.168	1.42	0.52
30	35JA30	JA	3.790	3.588	B	1 1/4	1 1/8	1 1/8	2 1/16	5/64	29/64	5/8	0.168	1.46	0.56
32	35JA32	JA	4.030	3.826	B	1 1/4	1 1/8	1 1/8	2 1/16	5/64	29/64	5/8	0.168	1.68	0.78
35	35JA35	JA	4.390	4.183	B	1 1/4	1 1/8	1 1/8	2 1/16	5/64	29/64	5/8	0.168	1.94	1.04
36	35SH36	SH	4.510	4.303	B	1 1/2	1 1/16	1 1/16	2 1/16	1 3/64	4 1/64	1 3/16	0.168	2.06	1.06
40	35SH40	SH	4.990	4.780	B	1 1/2	1 1/16	1 1/16	2 1/16	1 3/64	4 1/64	1 3/16	0.168	2.18	1.18
42	35SH42	SH	5.230	5.018	B	1 1/2	1 1/16	1 1/16	2 1/16	1 3/64	4 1/64	1 3/16	0.168	2.26	1.26
45	35SH45	SH	5.590	5.376	B	1 1/2	1 1/16	1 1/16	2 1/16	1 3/64	4 1/64	1 3/16	0.168	2.40	1.40
48	35SH48	SH	5.950	5.734	B	1 1/2	1 1/16	1 1/16	2 1/16	1 3/64	4 1/64	1 3/16	0.168	2.58	1.58
54	35SH54	SH	6.660	6.449	B	1 1/2	1 1/16	1 1/16	2 1/16	1 3/64	4 1/64	1 3/16	0.168	2.88	1.88
60	35SH60	SH	7.380	7.165	B	1 1/2	1 1/16	1 1/16	2 1/16	1 3/64	4 1/64	1 3/16	0.168	3.28	2.28
70	35SH70	SH	8.580	8.358	B	1 1/2	1 1/16	1 1/16	2 1/16	1 3/64	4 1/64	1 3/16	0.168	3.94	2.94
72	35SH72	SH	8.810	8.597	B	1 1/2	1 1/16	1 1/16	2 1/16	1 3/64	4 1/64	1 3/16	0.168	4.14	3.14
80	35SH80	SH	9.770	9.552	B	1 1/2	1 1/16	1 1/16	2 1/16	1 3/64	4 1/64	1 3/16	0.168	4.68	3.68
84	35SH84	SH	10.250	10.029	B	1 1/2	1 1/16	1 1/16	2 1/16	1 3/64	4 1/64	1 3/16	0.168	4.86	3.96
96	35SH96	SH	11.680	11.461	B	1 1/2	1 1/16	1 1/16	2 1/16	1 3/64	4 1/64	1 3/16	0.168	6.38	5.38
112	35SH112	SH	13.590	13.371	B	1 1/2	1 1/16	1 1/16	2 1/16	1 3/64	4 1/64	1 3/16	0.168	7.60	6.60

**No. 35**  
**3/8" Pitch**

**MST®**  
**Sprockets**

*Martin*

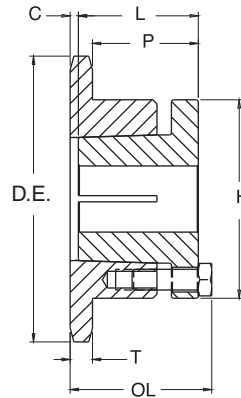

**TYPE 3**

**Single - MST® Sprockets**

No. Teeth	Catalog Number	Bushing	Diameters		Type	Max. Bore	Dimensions						Weight Lbs. (Approx.)	
			Outside Dia.	Pitch Dia.			OL	L	C	H	P	T(nom)	With Hub	Rim Only
19	35H19	H	2.470	2.278	3	1-1/2	1-1/2	1-1/4	1/16	2-1/2	1-5/32	0.168	1.3	0.5
20	35H20	H	2.590	2.397	3	1-1/2	1-1/2	1-1/4	1/16	2-1/2	1-5/32	0.168	1.3	0.5
21	35H21	H	2.710	2.516	3	1-1/2	1-1/2	1-1/4	1/16	2-1/2	1-5/32	0.168	1.4	0.6
22	35H22	H	2.830	2.635	3	1-1/2	1-1/2	1-1/4	1/16	2-1/2	1-5/32	0.168	1.5	0.7
23	35H23	H	2.950	2.754	3	1-1/2	1-1/2	1-1/4	1/16	2-1/2	1-5/32	0.168	1.5	0.7
24	35H24	H	3.070	2.873	3	1-1/2	1-1/2	1-1/4	1/16	2-1/2	1-5/32	0.168	1.6	0.8
25	35H25	H	3.190	2.992	3	1-1/2	1-1/2	1-1/4	1/16	2-1/2	1-5/32	0.168	1.6	0.8
26	35H26	H	3.310	3.111	3	1-1/2	1-1/2	1-1/4	1/16	2-1/2	1-5/32	0.168	1.6	0.8
28	35H28	H	3.550	3.349	3	1-1/2	1-1/2	1-1/4	1/16	2-1/2	1-5/32	0.168	1.7	0.9
30	35H30	H	3.790	3.588	3	1-1/2	1-1/2	1-1/4	1/16	2-1/2	1-5/32	0.168	1.7	0.9
32	35H32	H	4.030	3.826	3	1-1/2	1-1/2	1-1/4	1/16	2-1/2	1-5/32	0.168	1.7	0.9
35	35H35	H	4.390	4.183	3	1-1/2	1-1/2	1-1/4	1/16	2-1/2	1-5/32	0.168	1.8	1.0
36	35H36	H	4.510	4.303	3	1-1/2	1-1/2	1-1/4	1/16	2-1/2	1-5/32	0.168	1.8	1.0
40	35H40	H	4.990	4.780	3	1-1/2	1-1/2	1-1/4	1/16	2-1/2	1-5/32	0.168	2.0	1.2
42	35H42	H	5.230	5.018	3	1-1/2	1-1/2	1-1/4	1/16	2-1/2	1-5/32	0.168	2.0	1.2
45	35H45	H	5.590	5.376	3	1-1/2	1-1/2	1-1/4	1/16	2-1/2	1-5/32	0.168	2.2	1.4
48	35H48	H	5.950	5.734	3	1-1/2	1-1/2	1-1/4	1/16	2-1/2	1-5/32	0.168	2.3	1.5
54	35H54	H	6.660	6.449	3	1-1/2	1-1/2	1-1/4	1/16	2-1/2	1-5/32	0.168	2.6	1.8
60	35H60	H	7.380	7.165	3	1-1/2	1-1/2	1-1/4	1/16	2-1/2	1-5/32	0.168	3.1	2.3
70	35H70	H	8.580	8.358	3	1-1/2	1-1/2	1-1/4	1/16	2-1/2	1-5/32	0.168	3.6	2.8
72	35H72	H	8.810	8.597	3	1-1/2	1-1/2	1-1/4	1/16	2-1/2	1-5/32	0.168	3.8	3.0
80	35H80	H	9.770	9.552	3	1-1/2	1-1/2	1-1/4	1/16	2-1/2	1-5/32	0.168	4.6	3.8
84	35H84	H	10.250	10.029	3	1-1/2	1-1/2	1-1/4	1/16	2-1/2	1-5/32	0.168	4.8	4.0
96	35H96	H	11.680	11.461	3	1-1/2	1-1/2	1-1/4	1/16	2-1/2	1-5/32	0.168	6.1	5.3
112	35H112	H	13.590	13.371	3	1-1/2	1-1/2	1-1/4	1/16	2-1/2	1-5/32	0.168	7.6	6.8



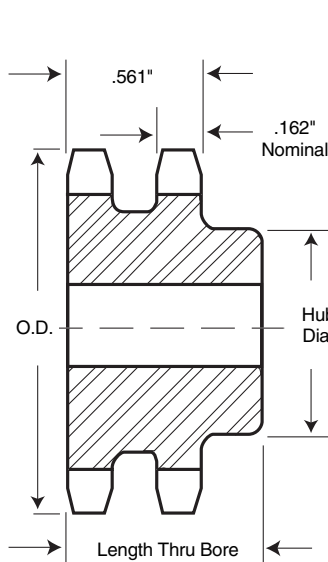

**TYPE B**

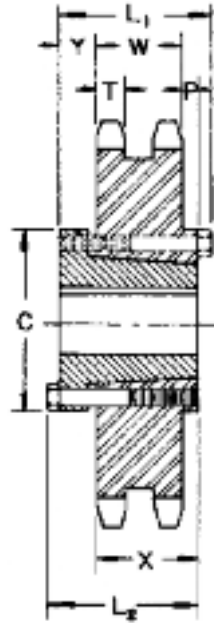

**QD — TYPE C**

### Double - Type B

No. Teeth	Catalog Number	Outside Diameter	Type	Bore (inches)		Hub (inches)		Weight Lbs. (Approx.)
				Stock	Rec. Max.	Dia.	Length Thru	
12	D35B12H	1.630	B	1/2	3/8	5/8	1 1/4	0.32
13	D35B13H	1.750	B	1/2	1/2	1 1/4	1 1/4	0.36
14	D35B14H	1.870	B	1/2	3/4	1 1/2	1 1/4	0.44
15	D35B15H	1.990	B	1/2	1/2	1 1/2	1 1/4	0.56
16	D35B16H	2.110	B	1/2	1/2	1 1/2	1 1/4	0.64
17	D35B17H	2.230	B	1/2	1 1/8	1 1/2	1 1/4	0.74
18	D35B18H	2.350	B	1/2	1 1/8	1 1/2	1 1/4	0.84
19	D35B19H	2.470	B	1/2	1 1/8	1 1/2	1 1/4	0.96
20	D35B20H	2.590	B	3/4	1 1/8	1 1/2	1 1/4	1.08
21	D35B21H	2.710	B	3/4	1 1/8	2 1/8	1 1/4	1.24
22	D35B22H	2.830	B	3/4	1 1/8	2 1/8	1 1/4	1.42
23	D35B23H	2.950	B	3/4	1 1/2	2 1/4	1 1/4	1.54
24	D35B24H	3.070	B	3/4	1 1/2	2 1/4	1 1/4	1.62
25	D35B25H	3.190	B	3/4	1 1/2	2 1/4	1 1/4	1.66
26	D35B26	3.310	B	3/4	1 1/2	2 1/4	1 1/4	1.98
30	D35B30	3.790	B	3/4	1 1/2	2 1/2	1 1/4	2.34
36	D35B36	4.510	B	3/4	1 1/2	2 1/2	1 1/4	3.00
42	D35B42	5.230	B	3/4	1 1/2	2 1/2	1 1/4	3.80
48	D35B48	5.950	B	3/4	1 1/2	2 1/2	1 1/4	4.66
52	D35B52	6.430	B	3/4	1 1/2	2 1/2	1 1/4	5.40
60	D35B60	7.380	B	3/4	1 1/2	2 1/2	1 1/4	6.84
68	D35B68	8.340	B	3/4	2 1/8	3 1/8	1 1/2	10.01
72	D35B72	8.810	B	3/4	2 1/8	3 1/8	1 1/2	11.04
76	D35B76	9.290	B	3/4	2 1/8	3 1/8	1 1/2	11.94
84	D35B84	10.250	B	3/4	2 1/8	3 1/8	1 1/2	14.98
95	D35B95	11.560	B	1	2 1/8	3 1/8	1 1/2	17.42
96	D35B96	11.680	B	1	2 1/8	3 1/8	1 1/2	18.14
102	D35B102	12.400	B	1	2 1/8	3 1/8	1 1/2	19.92

Maximum bores shown will accommodate standard keyseat and setscrew over keyseat. Slightly larger bores are possible with no keyseat, shallow keyseat, or setscrew at angle to keyseat. Sprockets with "H" suffix have hardened teeth.

### Double - Taper Bushed

No. Teeth	Catalog Number	Bushing	Diameters		Max. Bore	Dimensions			Type	Weight Lbs. (Approx.)	
			Outside Diameter	Pitch Diameter		L	C	Rim Only		Bushing Only	
19	D35BTB19H	1008	2.472	2.278	1	7/8	1 5/8	B	0.6	0.3	
20	D35BTB20H	1008	2.593	2.397	1	7/8	1 5/8	B	0.8	0.3	
21	D35BTB21H	1008	2.713	2.516	1	7/8	2 1/8	B	1.4	0.3	
22	D35BTB22H	1008	2.833	2.635	1	7/8	2 1/8	B	1.7	0.3	
24	D35BTB24H	1210	3.074	2.873	1 1/4	1	2 1/8	B	1.8	0.6	
26	D35BTB26	1210	3.314	3.111	1 1/4	1	2 1/8	B	2.0	0.6	
30	D35BTB30	1610	3.793	3.588	1 1/4	1	3 1/8	B	1.8	0.9	
32	D35BTB32	1610	4.032	3.826	1 1/4	1	3 1/8	B	2.0	0.9	
35	D35BTB35	1610	4.392	4.183	1 1/4	1	3 1/8	B	2.3	0.9	
40	D35BTB40	1610	4.990	4.780	1 1/4	1	3 1/8	B	2.9	0.9	
45	D35BTB45	1610	5.588	5.376	1 1/4	1	3 1/8	B	3.2	0.9	
48	D35BTB48	1610	5.946	5.734	1 1/4	1	3 1/8	B	3.5	0.9	
54	D35BTB54	1610	6.663	6.449	1 1/4	1	3 1/8	B	3.9	0.9	
60	D35BTB60	1610	7.380	7.165	1 1/4	1	3 1/8	B	4.9	0.9	
70	D35BTB70	1610	8.575	8.358	1 1/4	1	3 1/8	B	6.3	0.9	
80	D35BTB80	1610	9.770	9.552	1 1/4	1	3 1/8	B	7.9	0.9	
96	D35BTB96	1610	11.680	11.461	1 1/4	1	3 1/8	B	9.9	0.9	
112	D35BTB112	1610	13.590	13.371	1 1/4	1	3 1/8	B	10.9	0.9	

Sprockets with "H" suffix have hardened teeth.

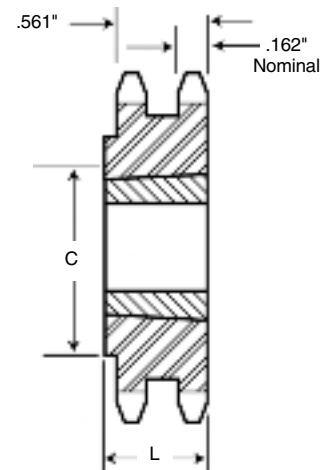

**TAPER BUSHED TYPE B**

### Double - Type QD

No. Teeth	Catalog Number	Bush-ing	Diameters		Type	Max. Bore	Dimensions							Weight Lbs. (Approx.)		
			Outside Diameter	Pitch Diameter			L <sub>1</sub>	L <sub>2</sub>	C	Y	P	X	T	W	With Hub	Rim Onl
68	D35SDS68	SDS	8.340	8.120	C	2	1 1/2	1 1/2	3 3/8	3/8	3/8	3/8	0.162	0.561	8.40	7.40
72	D35SDS72	SDS	8.810	8.597	C	2	1 1/2	1 1/2	3 3/8	3/8	3/8	3/8	0.162	0.561	9.28	8.28
76	D35SDS76	SDS	9.290	9.074	C	2	1 1/2	1 1/2	3 3/8	3/8	3/8	3/8	0.162	0.561	10.32	9.32
84	D35SK84	SK	10.250	10.029	C	2 1/2	2 1/2	2 1/2	3 3/8	3/8	1/2	1 1/4	0.162	0.561	13.94	11.94
95	D35SK95	SK	11.560	11.342	C	2 1/2	2 1/2	2 1/2	3 3/8	3/8	1/2	1 1/4	0.162	0.561	17.22	15.22
96	D35SK96	SK	11.680	11.461	C	2 1/2	2 1/2	2 1/2	3 3/8	3/8	1/2	1 1/4	0.162	0.561	17.74	15.74
102	D35SK102	SK	12.400	12.177	C	2 1/2	2 1/2	2 1/2	3 3/8	3/8	1/2	1 1/4	0.162	0.561	19.76	17.76

# No. 35-3

## 3/8" Pitch

# All Steel Stock Sprockets

# Martin

## Triple - Type B

No. Teeth	Catalog Number	Outside Diameter	Type	Bore (inches)		Hub (inches)		Weight Lbs. (Approx.)
				Stock	Rec. Max.	Dia.	Length Thru	
13	E35B13H	1.750	B	1/2	11/16	1 1/4	1 3/4	0.50
14	E35B14H	1.870	B	1/2	7/8	1 1/4	1 3/4	0.62
15	E35B15H	1.990	B	1/2	15/16	1 13/16	1 3/4	0.78
16	E35B16H	2.110	B	1/2	15/16	1 5/8	1 3/4	0.82
17	E35B17H	2.230	B	1/2	1 1/16	1 7/8	1 3/4	1.04
18	E35B18H	2.350	B	1/2	1 3/16	1 7/8	1 3/4	1.22
19	E35B19H	2.470	B	1/2	1 1/8	1 7/8	1 3/4	1.40
20	E35B20H	2.590	B	3/4	1 1/8	1 7/8	1 3/4	1.50
21	E35B21H	2.710	B	3/4	1 1/8	2 1/8	1 3/4	1.72
22	E35B22H	2.830	B	3/4	1 1/8	2 1/8	1 3/4	1.96
23	E35B23H	2.950	B	3/4	1 1/2	2 1/4	1 3/4	2.12
24	E35B24H	3.070	B	3/4	1 1/2	2 1/4	1 3/4	2.26
25	E35B25H	3.190	B	3/4	1 1/2	2 1/4	1 3/4	2.42
26	E35B26	3.310	B	3/4	1 1/2	2 1/2	1 3/4	2.78
30	E35B30	3.790	B	3/4	1 3/4	2 1/2	1 3/4	3.42
36	E35B36	4.510	B	3/4	1 3/4	2 1/2	1 3/4	4.52
42	E35B42	5.230	B	3/4	1 3/4	2 1/2	1 3/4	5.88
48	E35B48	5.950	B	3/4	1 3/4	2 1/2	1 3/4	7.42
52	E35B52	6.430	B	3/4	1 3/4	2 1/2	1 3/4	8.52
60	E35B60	7.380	B	3/4	1 3/4	2 1/2	1 3/4	11.22
68	E35B68	8.340	B	3/4	2 3/8	3 1/8	1 3/4	15.38
72	E35B72	8.810	B	3/4	2 3/8	3 1/8	1 3/4	17.34
76	E35B76	9.290	B	3/4	2 3/8	3 1/8	1 3/4	18.90
84	E35B84	10.250	B	3/4	2 3/8	3 1/8	1 3/4	22.82
95	E35B95	11.560	B	1	2 1/2	3 3/4	2 1/2	29.32
96	E35B96	11.680	B	1	2 1/2	3 3/4	2 1/2	30.06
102	E35B102	12.400	B	1	2 1/2	3 3/4	2 1/2	33.36

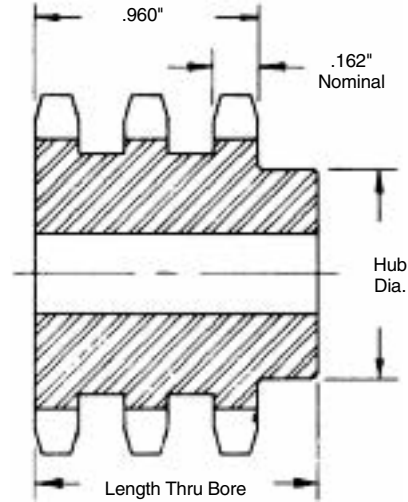

**TYPE B**

### Alteration Charges

See current discount sheet for alteration charges.

Maximum bores shown will accommodate standard keyseat and setscrew over keyseat. Slightly larger bores are possible with no keyseat, shallow keyseat, or setscrew at angle to keyseat.

NOTE: Triple 35 stock sprockets with 25 teeth or less have hardened teeth. Sprockets with "H" suffix have hardened teeth.

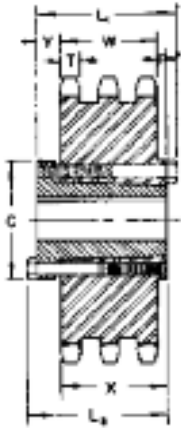

**QD — TYPE C**

## Triple - Type QD

No. Teeth	Catalog Number	Bush-ing	Diameters		Type	Max. Bore	Dimensions								Weight (Approx.)	
			Outside Diameter	Pitch Diameter			L <sub>1</sub>	L <sub>2</sub>	C	Y	P	X	T	W	With Hub	Rim Only
68	E35SK68	SK	8.340	8.120	C	2 3/8	2 1/2	2 1/2	3 3/8	5/8	1 9/16	1 1/4	0.162	0.960	13.90	11.90
72	E35SK72	SK	8.810	8.597	C	2 3/8	2 1/2	2 1/2	3 3/8	5/8	1 9/16	1 1/4	0.162	0.960	15.56	13.56
76	E35SK76	SK	9.290	9.074	C	2 3/8	2 1/2	2 1/2	3 3/8	5/8	1 9/16	1 1/4	0.162	0.960	17.42	15.42
84	E35SK84	SK	10.250	10.029	C	2 3/8	2 1/2	2 1/2	3 3/8	5/8	1 9/16	1 1/4	0.162	0.960	20.92	18.92
95	E35SK95	SK	11.560	11.342	C	2 3/8	2 1/2	2 1/2	3 3/8	5/8	1 9/16	1 1/4	0.162	0.960	26.76	24.76
96	E35SK96	SK	11.680	11.461	C	2 3/8	2 1/2	2 1/2	3 3/8	5/8	1 9/16	1 1/4	0.162	0.960	27.58	25.58
102	E35SK102	SK	12.400	12.177	C	2 3/8	2 1/2	2 1/2	3 3/8	5/8	1 9/16	1 1/4	0.162	0.960	31.18	29.18



**BORED-TO-SIZE**

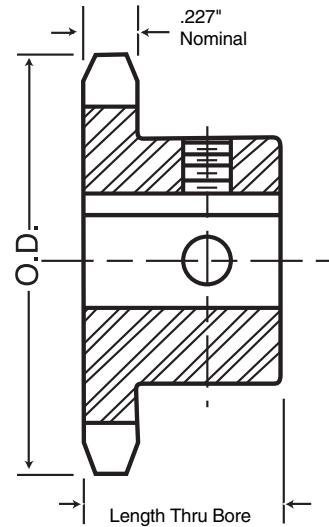

**TYPE BS**

### Single - Type BS — 2 Setscrews — Bored-To-Size

No. Teeth	Catalog Number	Outside Diameter	Length Thru Bore	Weight Lbs. (Approx.)	Stock Finished Bores Includes Keyway and 2 Setscrews
9	41BS9	1.670	7/8	0.20	— *1/2 — 5/8
10	41BS10	1.840	7/8	0.25	— *1/2 — 5/8
11	41BS11	2.000	7/8	0.32	— *1/2 — 5/8 — 3/4
12	41BS12	2.170	7/8	0.33	— *1/2 — 5/8 — 3/4 — 7/8
13	41BS13	2.330	7/8	0.43	— *1/2 — 5/8 — 3/4 — 7/8 — 1
14	41BS14	2.490	7/8	0.48	— *1/2 — 5/8 — 3/4 — 7/8 — 1
15	41BS15	2.650	7/8	0.59	— *1/2 — 5/8 — 3/4 — — 1
16	41BS16	2.810	7/8	0.72	— 5/8 — 3/4 — — 1
17	41BS17	2.970	1	1.00	— 5/8 — 3/4 — — 1
18	41BS18	3.140	1	1.10	— 5/8 — 3/4 — — 1
19	41BS19	3.300	1	1.21	— 5/8 — 3/4 — — 1
20	41BS20	3.460	1	1.39	— 5/8 — 3/4 — — 1
21	41BS21	3.620	1	1.77	— 5/8 — 3/4 — — 1
22	41BS22	3.780	1	1.92	— 5/8 — 3/4 — — 1
23	41BS23	3.940	1	2.18	— 5/8 — 3/4 — — 1
24	41BS24	4.100	1	2.24	— 5/8 — 3/4 — — 1
25	41BS25	4.260	1	2.42	— 5/8 — 3/4 — — 1
26	41BS26	4.420	1	2.46	— 5/8 — 3/4 — — 1
27	41BS27	4.580	1	2.52	— 5/8 — 3/4 — — 1
28	41BS28	4.740	1	2.60	— 5/8 — 3/4 — — 1
30	41BS30	5.060	1	2.76	— 5/8 — 3/4 — — 1
32	41BS32	5.380	1	2.92	— 5/8 — 3/4 — — 1
35	41BS35	5.860	1	3.08	— 5/8 — 3/4 — — 1
36	41BS36	6.020	1	3.28	— 5/8 — 3/4 — — 1
40	41BS40	6.650	1 1/16	3.82	— 5/8 — 3/4 — — 1 — 1 1/8 — 1 3/16 — 1 1/4 — 1 5/8 — 1 7/8 — 1 1/2
42	41BS42	6.970	1 1/16	3.68	— 5/8 — 3/4 — — 1 — 1 1/8 — 1 3/16 — 1 1/4 — 1 5/8 — 1 7/8 — 1 1/2
45	41BS45	7.450	1 1/16	3.94	— 5/8 — 3/4 — — 1 — 1 1/8 — 1 3/16 — 1 1/4 — 1 5/8 — 1 7/8 — 1 1/2
48	41BS48	7.930	1 1/16	4.68	— 5/8 — 3/4 — — 1 — 1 1/8 — 1 3/16 — 1 1/4 — 1 5/8 — 1 7/8 — 1 1/2
54	41BS54	8.880	1 1/16	5.44	— 5/8 — 3/4 — — 1 — 1 1/8 — 1 3/16 — 1 1/4 — 1 5/8 — 1 7/8 — 1 1/2
60	41BS60	9.840	1 1/16	6.54	— 5/8 — 3/4 — — 1 — 1 1/8 — 1 3/16 — 1 1/4 — 1 5/8 — 1 7/8 — 1 1/2
70	41BS70	11.430	1 3/16	9.28	— 5/8 — 3/4 — — 1 — 1 1/8 — 1 3/16 — 1 1/4 — 1 5/8 — 1 7/8 — 1 1/2
72	41BS72	11.750	1 3/16	9.38	— 5/8 — 3/4 — — 1 — 1 1/8 — 1 3/16 — 1 1/4 — 1 5/8 — 1 7/8 — 1 1/2
80	41BS80	13.030	1 3/16	11.28	— 5/8 — 3/4 — — 1 — 1 1/8 — 1 3/16 — 1 1/4 — 1 5/8 — 1 7/8 — 1 1/2
84	41BS84	13.660	1 3/16	11.94	— 5/8 — 3/4 — — 1 — 1 1/8 — 1 3/16 — 1 1/4 — 1 5/8 — 1 7/8 — 1 1/2
96	41BS96	15.570	1 3/16	14.51	1 — 1 1/8 — 1 3/16 — 1 1/4 — 1 5/8 — 1 7/8 — 1 1/2
112	41BS112	18.120	1 3/16	18.81	1 — 1 1/8 — 1 3/16 — 1 1/4 — 1 5/8 — 1 7/8 — 1 1/2

\* Indicates no keyway. (2) 1/4" setscrews only in 1/2" bore. Hub diameters vary to suit different bore sizes.

NOTE: KEYWAY IS ON CENTER LINE OF TOOTH.

# No. 41

## 1/2" Pitch

# All Steel & Stainless Steel Stock Sprockets

# Martin

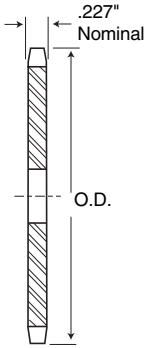

TYPE A

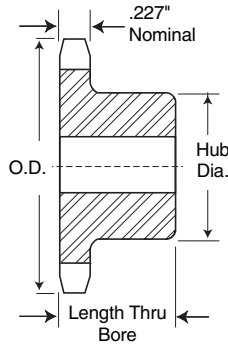

TYPE B

### Single - Type B

### Single - Type A

No. Teeth	Catalog Number	Outside Diameter	Type	Bore (inches)		Hub (inches)		Weight Lbs. (Approx.)	Type	Catalog Number	Stock Bore	Weight Lbs. (Approx.)
				Stock	Rec. Max.	Diameter	Length Thru Bore					
6	41B6	1.170	B	3/8	3/8	2 1/2★	7/8	0.07				
7	41B7	1.340	B	3/8	3/8	3/4★	7/8	0.10				
8	41B8	1.510	B	1/2	1/2	5/8★	7/8	0.19				
9	41B9	1.670	B	1/2	3/4	1 1/8★	7/8	0.20				
10	41B10	1.840	B	1/2	3/4	1 1/4★	7/8	0.27				
11	41B11	2.000	B	1/2	7/8	1 1/2★	7/8	0.35				
12	41B12	2.170	B	1/2	1 1/8	1 5/8★	7/8	0.44				
13	41B13	2.330	B	1/2	1	1 7/8	7/8	0.50				
14	41B14	2.490	B	1/2	1 1/4	1 3/4	7/8	0.57				
15	41B15	2.650	B	1/2	1 1/2	1 31/32	7/8	0.72	A	41A15	5/8	0.28
16	41B16	2.810	B	3/4	1 3/4	2 1/16	7/8	0.91	A	41A16	5/8	0.34
17	41B17	2.970	B	3/4	1 1/2	2 1/8	1	1.09	A	41A17	5/8	0.36
18	41B18	3.140	B	3/4	1 1/2	2 3/8	1	1.25	A	41A18	5/8	0.44
19	41B19	3.300	B	3/4	1 3/4	2 11/32	1	1.49	A	41A19	5/8	0.46
20	41B20	3.460	B	3/4	1 3/4	2 3/4	1	1.64	A	41A20	5/8	0.52
21	41B21	3.620	B	3/4	1 3/4	2 7/8	1	1.81	A	41A21	5/8	0.60
22	41B22	3.780	B	3/4	2	3	1	1.93	A	41A22	5/8	0.66
23	41B23	3.940	B	3/4	2 1/4	3 1/8	1	2.25	A	41A23	5/8	0.72
24	41B24	4.100	B	3/4	2 1/4	3 1/4	1	2.33	A	41A24	5/8	0.82
25	41B25	4.260	B	3/4	2 1/4	3 1/2	1	2.46	A	41A25	5/8	0.88
26	41B26	4.420	B	3/4	2 1/2	3 3/4	1	2.50	A	41A26	5/8	0.94
27	41B27	4.580	B	3/4	2 1/2	3 3/4	1	2.56	A	41A27	5/8	1.00
28	41B28	4.740	B	3/4	2 1/2	3 3/4	1	2.64	A	41A28	5/8	1.08
30	41B30	5.060	B	3/4	2 1/2	3 3/4	1	2.80	A	41A30	19/32	1.20
32	41B32	5.380	B	3/4	2 1/2	3 3/4	1	2.96	A	41A32	19/32	1.44
35	41B35	5.860	B	3/4	2 3/4	3 3/4	1	3.12	A	41A35	19/32	1.70
36	41B36	6.020	B	3/4	2 3/4	3 3/4	1	3.32	A	41A36	19/32	1.84
40	41B40	6.650	B	3/4	2 3/4	3 3/4	1 1/16	4.06	A	41A40	23/32	2.22
42	41B42	6.970	B	3/4	2 3/4	3 3/4	1 1/16	4.10	A	41A42	23/32	2.50
45	41B45	7.450	B	3/4	2 3/4	3 3/4	1 1/16	4.18	A	41A45	23/32	2.52
48	41B48	7.930	B	3/4	2 3/4	3 3/4	1 1/16	4.92	A	41A48	23/32	2.92
54	41B54	8.880	B	3/4	2 3/4	3 3/4	1 1/16	5.68	A	41A54	23/32	3.54
60	41B60	9.840	B	3/4	2 3/4	3 3/4	1 1/16	6.78	A	41A60	23/32	4.60
70	41B70	11.430	B	3/4	2 3/4	4	1 1/16	9.54	A	41A70	23/32	6.22
72	41B72	11.750	B	3/4	2 3/4	4	1 1/16	9.64	A	41A72	23/32	6.32
80	41B80	13.030	B	3/4	2 3/4	4	1 1/16	11.54	A	41A80	23/32	8.46
84	41B84	13.660	B	3/4	2 3/4	4	1 1/16	12.20	A	41A84	23/32	9.12
96	41B96	15.570	B	1	2 3/4	4	1 1/16	14.86	A	41A96	1 1/16	11.84
112	41B112	18.120	B	1	2 3/4	4	1 1/16	19.16	A	41A112	1 1/16	15.84

### Single - Type B — Stainless

### Single - Type A — Stainless

No. Teeth	Catalog Number	Outside Diameter	Type	Bore (inches)		Hub (inches)		Weight Lbs. (Approx.)	Type	Catalog Number	Stock Bore	Weight Lbs. (Approx.)
				Stock	Rec. Max.	Diameter	Length Thru Bore					
9	41B9SS	1.670	B	1/2	3/4	1 1/8★	7/8	0.20				
10	41B10SS	1.840	B	1/2	3/4	1 1/4★	7/8	0.27				
11	41B11SS	2.000	B	1/2	7/8	1 1/2★	7/8	0.35				
12	41B12SS	2.170	B	1/2	1 1/8	1 5/8★	7/8	0.44				
13	41B13SS	2.330	B	1/2	1	1 7/8	7/8	0.50				
14	41B14SS	2.490	B	1/2	1 1/4	1 3/4	7/8	0.57				
15	41B15SS	2.650	B	3/4	1 1/2	1 31/32	7/8	0.72				
16	41B16SS	2.810	B	3/4	1 3/4	2 1/16	7/8	0.91				
17	41B17SS	2.970	B	3/4	1 1/2	2 1/8	1	1.09				
18	41B18SS	3.140	B	3/4	1 3/4	2 3/8	1	1.25				
19	41B19SS	3.300	B	3/4	1 3/4	2 11/32	1	1.49				
20	41B20SS	3.460	B	3/4	1 3/4	2 3/4	1	1.64				

★ Has recessed groove in hub for chain clearance.

Maximum bores shown will accommodate standard keyseat and setscrew over keyseat. Slightly larger bores are possible with no keyseat, shallow keyseat, or setscrew at angle to keyseat.

### Single - Taper Bushed

No. Teeth	Catalog Number	Bushing	Diameters		Max. Bore	Dimensions		Type	Weight Lbs. (Approx.)	
			Outside Diameter	Pitch Diameter		L	C		Rim Only	Bushing Only
14	41BTB14	1008	2.490	2.247	1	3/8	1 1/8*	B	0.4	0.3
15	41BTB15	1008	2.650	2.405	1	7/8	1 1/8	B	0.5	0.3
16	41BTB16	1008	2.810	2.503	1	7/8	2	B	0.6	0.3
17	41BTB17	1210	2.970	2.721	1 1/4	1	2 3/8*	B	0.7	0.6
18	41BTB18	1210	3.140	2.879	1 1/4	1	2 3/8	B	0.9	0.6
19	41BTB19	1210	3.300	3.038	1 1/4	1	2 1/2	B	1.1	0.6
20	41BTB20	1610	3.460	3.196	1 1/2	1	2 3/8*	B	1.1	0.9
21	41BTB21	1610	3.620	3.355	1 1/2	1	3*	B	1.2	0.9
22	41BTB22	1610	3.780	3.513	1 1/2	1	3	B	1.3	0.9
23	41BTB23	1610	3.940	3.672	1 1/2	1	3	B	1.4	0.9
24	41BTB24	1610	4.100	3.831	1 1/2	1	3	B	1.4	0.9
25	41BTB25	1610	4.260	3.989	1 1/2	1	3	B	1.5	0.9
26	41BTB26	1610	4.420	4.148	1 1/2	1	3	B	1.5	0.9
28	41BTB28	1610	4.740	4.466	1 1/2	1	3	B	1.7	0.9
30	41BTB30	1610	5.060	4.783	1 1/2	1	3	B	1.8	0.9
32	41BTB32	1610	5.380	5.101	1 1/2	1	3	B	1.9	0.9
35	41BTB35	1610	5.860	5.578	1 1/2	1	3	B	2.3	0.9
36	41BTB36	1610	6.020	5.737	1 1/2	1	3	B	2.4	0.9
40	41BTB40	1610	6.650	6.373	1 1/2	1	3	B	2.7	0.9
45	41BTB45	1610	7.450	7.168	1 1/2	1	3	B	3.5	0.9
48	41BTB48	1610	7.930	7.645	1 1/2	1	3	B	4.1	0.9
54	41BTB54	1610	8.880	8.599	1 1/2	1	3	B	4.9	0.9
60	41BTB60	1610	9.840	9.554	1 1/2	1	3	B	5.7	0.9
70	41BTB70	1610	11.430	11.145	1 1/2	1	3	B	7.4	0.9
72	41BTB72	1610	11.750	11.463	1 1/2	1	3	B	8.2	0.9
80	41BTB80	1610	13.030	12.736	1 1/2	1	3	B	9.6	0.9
96	41BTB96	1610	15.570	15.282	1 1/2	1	3	B	13.1	0.9

\* Has recessed groove in hub for chain clearance.

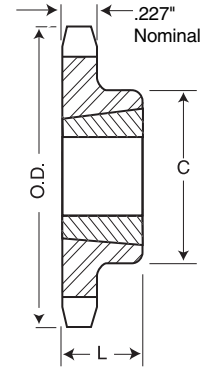

TAPER BUSHED  
TYPE B



### Single - Type QD

No. Teeth	Catalog Number	Bushing	Diameters		Type	Max. Bore	Dimensions						Weight Lbs. (Approx.)		
			Outside Diameter	Pitch Diameter			L <sub>1</sub>	L <sub>2</sub>	C	Y	G	X	T	With Hub	Rim Only
15	41JA15	JA	2.650	2.405	B	1 1/4	1 1/8	1 1/8	2 1/8	9/64	5/64	5/8	.227	1.22	0.32
16	41JA16	JA	2.810	2.563	B	1 1/4	1 1/8	1 1/8	2 1/8	9/64	5/64	5/8	.227	1.30	0.40
17	41JA17	JA	2.980	2.721	B	1 1/4	1 1/8	1 1/8	2 1/8	9/64	5/64	5/8	.227	1.40	0.50
18	41JA18	JA	3.140	2.879	B	1 1/4	1 1/8	1 1/8	2 1/8	9/64	5/64	5/8	.227	1.50	0.60
19	41JA19	JA	3.300	3.038	B	1 1/4	1 1/8	1 1/8	2 1/8	9/64	5/64	5/8	.227	1.58	0.68
20	41SH20	SH	3.460	3.196	B	1 1/2	1 1/8	1 1/8	2 1/8	1 1/32	3/64	13/16	.227	1.78	0.78
21	41SH21	SH	3.620	3.355	B	1 1/2	1 1/8	1 1/8	2 1/8	1 1/32	3/64	13/16	.227	1.82	0.82
22	41SH22	SH	3.780	3.513	B	1 1/2	1 1/8	1 1/8	2 1/8	1 1/32	3/64	13/16	.227	2.06	1.06
23	41SH23	SH	3.940	3.672	B	1 1/2	1 1/8	1 1/8	2 1/8	1 1/32	3/64	13/16	.227	2.14	1.14
24	41SH24	SH	4.100	3.831	B	1 1/2	1 1/8	1 1/8	2 1/8	1 1/32	3/64	13/16	.227	2.16	1.16
25	41SH25	SH	4.260	3.989	B	1 1/2	1 1/8	1 1/8	2 1/8	1 1/32	3/64	13/16	.227	2.22	1.22
26	41SH26	SH	4.420	4.148	B	1 1/2	1 1/8	1 1/8	2 1/8	1 1/32	3/64	13/16	.227	2.26	1.26
27	41SH27	SH	4.580	4.307	B	1 1/2	1 1/8	1 1/8	2 1/8	1 1/32	3/64	13/16	.227	2.40	1.40
28	41SH28	SH	4.740	4.466	B	1 1/2	1 1/8	1 1/8	2 1/8	1 1/32	3/64	13/16	.227	2.54	1.54
30	41SH30	SH	5.060	4.783	B	1 1/2	1 1/8	1 1/8	2 1/8	1 1/32	3/64	13/16	.227	2.58	1.58
32	41SH32	SH	5.380	5.101	B	1 1/2	1 1/8	1 1/8	2 1/8	1 1/32	3/64	13/16	.227	2.68	1.68
35	41SH35	SH	5.860	5.578	B	1 1/2	1 1/8	1 1/8	2 1/8	1 1/32	3/64	13/16	.227	2.79	1.79
36	41SDS36	SDS	6.020	5.737	B	2	1 1/2	1 1/2	3 3/8	1 1/32	17/32	3/4	.227	2.92	1.92
40	41SDS40	SDS	6.650	6.373	B	2	1 1/2	1 1/2	3 3/8	1 1/32	17/32	3/4	.227	3.32	2.32
42	41SDS42	SDS	6.970	6.691	B	2	1 1/2	1 1/2	3 3/8	1 1/32	17/32	3/4	.227	3.44	2.44
45	41SDS45	SDS	7.450	7.168	B	2	1 1/2	1 1/2	3 3/8	1 1/32	17/32	3/4	.227	3.76	2.76
48	41SDS48	SDS	7.930	7.645	B	2	1 1/2	1 1/2	3 3/8	1 1/32	17/32	3/4	.227	4.36	3.36
54	41SDS54	SDS	8.890	8.599	B	2	1 1/2	1 1/2	3 3/8	1 1/32	17/32	3/4	.227	4.98	3.98
60	41SDS60	SDS	9.840	9.554	B	2	1 1/2	1 1/2	3 3/8	1 1/32	17/32	3/4	.227	6.54	5.54
70	41SK70	SK	11.430	11.145	B	2 1/2	2 1/2	2 1/2	3 3/8	1 1/64	1 1/32	1 1/4	.227	9.42	7.42
72	41SK72	SK	11.750	11.463	B	2 1/2	2 1/2	2 1/2	3 3/8	1 1/64	1 1/32	1 1/4	.227	10.02	8.02
80	41SK80	SK	13.030	12.736	B	2 1/2	2 1/2	2 1/2	3 3/8	1 1/64	1 1/32	1 1/4	.227	11.64	9.64
84	41SK84	SK	13.660	13.372	B	2 1/2	2 1/2	2 1/2	3 3/8	1 1/64	1 1/32	1 1/4	.227	12.40	10.40
96	41SK96	SK	15.570	15.281	B	2 1/2	2 1/2	2 1/2	3 3/8	1 1/64	1 1/32	1 1/4	.227	14.82	12.82
112	41SK112	SK	18.120	17.828	B	2 1/2	2 1/2	2 1/2	3 3/8	1 1/64	1 1/32	1 1/4	.227	19.28	17.28

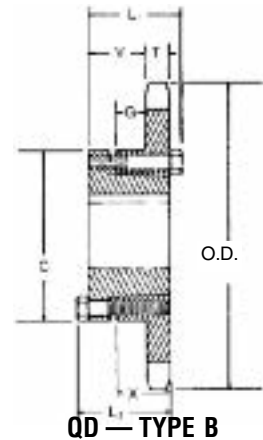

QD — TYPE B



# No. 40

## 1/2" Pitch

# All Steel Stock Sprockets

# Martin

### Single - Type BS — 2 Setscrews — Bored-To-Size

No. Teeth	Catalog Number	Outside Diameter	Length Thru Bore	Weight Lbs. (Approx.)	Stock Finished Bore Includes Keyway and 2 Setscrews
9	40BS9	1.670	3/8	0.16	*1/2 — 3/8
10	40BS10	1.840	3/8	0.24	*1/2 — 3/8 — 1/4
11	40BS11	2.000	3/8	0.28	*1/2 — 3/8 — 1/4 — 3/8
12	40BS12	2.170	3/8	0.34	*1/2 — 3/8 — 1/4 — 1/2 — 1
13	40BS13	2.330	3/8	0.45	*1/2 — 3/8 — 1/4 — 3/8 — 1
14	40BS14	2.490	3/8	0.51	*1/2 — 3/8 — 1/4 — 3/8 — 1 — 1 1/2
15	40BS15	2.650	3/8	0.53	*1/2 — 3/8 — 1/4 — 3/8 — 1 — 1 1/2 — 1 3/8 — 1 1/4
16	40BS16	2.810	3/8	0.66	% — 3/8 — 3/8 — 1 — 1 1/2 — 1 3/8 — 1 1/4
17	40BS17	2.970	1	0.88	% — 3/8 — 3/8 — 1 — 1 1/2 — 1 3/8 — 1 1/4
18	40BS18	3.140	1	1.03	% — 3/8 — 3/8 — 1 — 1 1/2 — 1 3/8 — 1 1/4 — 1 3/8 — 1 1/2 — 1 1/2
19	40BS19	3.300	1	1.17	% — 3/8 — 3/8 — 1 — 1 1/2 — 1 3/8 — 1 1/4 — 1 3/8 — 1 1/2 — 1 1/2
20	40BS20	3.460	1	1.33	% — 3/8 — 3/8 — 1 — 1 1/2 — 1 3/8 — 1 1/4 — 1 3/8 — 1 1/2 — 1 1/2
21	40BS21	3.620	1	1.53	% — 3/8 — 3/8 — 1 — 1 1/2 — 1 3/8 — 1 1/4 — 1 3/8 — 1 1/2 — 1 1/2
22	40BS22	3.780	1	1.66	% — 3/8 — 3/8 — 1 — 1 1/2 — 1 3/8 — 1 1/4 — 1 3/8 — 1 1/2 — 1 1/2
23	40BS23	3.940	1	1.92	% — 3/8 — 3/8 — 1 — 1 1/2 — 1 3/8 — 1 1/4 — 1 3/8 — 1 1/2 — 1 1/2
24	40BS24	4.100	1	2.10	% — 3/8 — 3/8 — 1 — 1 1/2 — 1 3/8 — 1 1/4 — 1 3/8 — 1 1/2 — 1 1/2
25	40BS25	4.260	1	2.22	% — 3/8 — 3/8 — 1 — 1 1/2 — 1 3/8 — 1 1/4 — 1 3/8 — 1 1/2 — 1 1/2
26	40BS26	4.420	1	2.34	% — 3/8 — 3/8 — 1 — 1 1/2 — 1 3/8 — 1 1/4 — 1 3/8 — 1 1/2 — 1 1/2
27	40BS27	4.580	1	2.42	% — 3/8 — 3/8 — 1 — 1 1/2 — 1 3/8 — 1 1/4 — 1 3/8 — 1 1/2 — 1 1/2
28	40BS28	4.740	1	2.50	% — 3/8 — 3/8 — 1 — 1 1/2 — 1 3/8 — 1 1/4 — 1 3/8 — 1 1/2 — 1 1/2
29	40BS29	4.900	1	2.60	% — 3/8 — 3/8 — 1 — 1 1/2 — 1 3/8 — 1 1/4 — 1 3/8 — 1 1/2 — 1 1/2
30	40BS30	5.060	1	2.70	% — 3/8 — 3/8 — 1 — 1 1/2 — 1 3/8 — 1 1/4 — 1 3/8 — 1 1/2 — 1 1/2
31	40BS31	5.220	1	2.88	% — 3/8 — 3/8 — 1 — 1 1/2 — 1 3/8 — 1 1/4 — 1 3/8 — 1 1/2 — 1 1/2
32	40BS32	5.380	1	3.00	% — 3/8 — 3/8 — 1 — 1 1/2 — 1 3/8 — 1 1/4 — 1 3/8 — 1 1/2 — 1 1/2
33	40BS33	5.540	1	3.03	% — 3/8 — 3/8 — 1 — 1 1/2 — 1 3/8 — 1 1/4 — 1 3/8 — 1 1/2 — 1 1/2
34	40BS34	5.700	1	3.11	% — 3/8 — 3/8 — 1 — 1 1/2 — 1 3/8 — 1 1/4 — 1 3/8 — 1 1/2 — 1 1/2
35	40BS35	5.860	1	3.20	% — 3/8 — 3/8 — 1 — 1 1/2 — 1 3/8 — 1 1/4 — 1 3/8 — 1 1/2 — 1 1/2
36	40BS36	6.020	1	3.39	% — 3/8 — 3/8 — 1 — 1 1/2 — 1 3/8 — 1 1/4 — 1 3/8 — 1 1/2 — 1 1/2
37	40BS37	6.170	1	3.45	% — 3/8 — 3/8 — 1 — 1 1/2 — 1 3/8 — 1 1/4 — 1 3/8 — 1 1/2 — 1 1/2
38	40BS38	6.330	1	3.50	% — 3/8 — 3/8 — 1 — 1 1/2 — 1 3/8 — 1 1/4 — 1 3/8 — 1 1/2 — 1 1/2
39	40BS39	6.490	1	4.00	% — 3/8 — 3/8 — 1 — 1 1/2 — 1 3/8 — 1 1/4 — 1 3/8 — 1 1/2 — 1 1/2
40	40BS40	6.650	1 1/8	4.28	— 3/8 — 3/8 — 1 — 1 1/2 — 1 3/8 — 1 1/4 — 1 3/8 — 1 1/2 — 1 1/2
41	40BS41	6.810	1 1/8	4.58	— 3/8 — 3/8 — 1 — 1 1/2 — 1 3/8 — 1 1/4 — 1 3/8 — 1 1/2 — 1 1/2
42	40BS42	6.970	1 1/8	4.64	— 3/8 — 3/8 — 1 — 1 1/2 — 1 3/8 — 1 1/4 — 1 3/8 — 1 1/2 — 1 1/2
43	40BS43	7.130	1 1/8	4.80	— 3/8 — 3/8 — 1 — 1 1/2 — 1 3/8 — 1 1/4 — 1 3/8 — 1 1/2 — 1 1/2
44	40BS44	7.290	1 1/8	4.96	— 3/8 — 3/8 — 1 — 1 1/2 — 1 3/8 — 1 1/4 — 1 3/8 — 1 1/2 — 1 1/2
45	40BS45	7.450	1 1/8	5.06	— 3/8 — 3/8 — 1 — 1 1/2 — 1 3/8 — 1 1/4 — 1 3/8 — 1 1/2 — 1 1/2
46	40BS46	7.610	1 1/8	5.19	— 3/8 — 3/8 — 1 — 1 1/2 — 1 3/8 — 1 1/4 — 1 3/8 — 1 1/2 — 1 1/2
47	40BS47	7.770	1 1/8	5.26	— 3/8 — 3/8 — 1 — 1 1/2 — 1 3/8 — 1 1/4 — 1 3/8 — 1 1/2 — 1 1/2
48	40BS48	7.930	1 1/8	5.66	— 3/8 — 3/8 — 1 — 1 1/2 — 1 3/8 — 1 1/4 — 1 3/8 — 1 1/2 — 1 1/2
49	40BS49	8.090	1 1/8	5.72	— 3/8 — 3/8 — 1 — 1 1/2 — 1 3/8 — 1 1/4 — 1 3/8 — 1 1/2 — 1 1/2
50	40BS50	8.250	1 1/8	5.78	— 3/8 — 3/8 — 1 — 1 1/2 — 1 3/8 — 1 1/4 — 1 3/8 — 1 1/2 — 1 1/2
51	40BS51	8.410	1 1/8	5.90	— 3/8 — 3/8 — 1 — 1 1/2 — 1 3/8 — 1 1/4 — 1 3/8 — 1 1/2 — 1 1/2
52	40BS52	8.570	1 1/8	5.94	— 3/8 — 3/8 — 1 — 1 1/2 — 1 3/8 — 1 1/4 — 1 3/8 — 1 1/2 — 1 1/2
53	40BS53	8.730	1 1/8	6.12	— 3/8 — 3/8 — 1 — 1 1/2 — 1 3/8 — 1 1/4 — 1 3/8 — 1 1/2 — 1 1/2
54	40BS54	8.880	1 1/8	6.24	— 3/8 — 3/8 — 1 — 1 1/2 — 1 3/8 — 1 1/4 — 1 3/8 — 1 1/2 — 1 1/2
55	40BS55	9.040	1 1/8	6.66	— 3/8 — 3/8 — 1 — 1 1/2 — 1 3/8 — 1 1/4 — 1 3/8 — 1 1/2 — 1 1/2
56	40BS56	9.200	1 1/8	6.71	— 3/8 — 3/8 — 1 — 1 1/2 — 1 3/8 — 1 1/4 — 1 3/8 — 1 1/2 — 1 1/2
57	40BS57	9.360	1 1/8	6.94	— 3/8 — 3/8 — 1 — 1 1/2 — 1 3/8 — 1 1/4 — 1 3/8 — 1 1/2 — 1 1/2
58	40BS58	9.520	1 1/8	7.17	— 3/8 — 3/8 — 1 — 1 1/2 — 1 3/8 — 1 1/4 — 1 3/8 — 1 1/2 — 1 1/2
59	40BS59	9.680	1 1/8	7.38	— 3/8 — 3/8 — 1 — 1 1/2 — 1 3/8 — 1 1/4 — 1 3/8 — 1 1/2 — 1 1/2
60	40BS60	9.840	1 1/8	7.68	— 3/8 — 3/8 — 1 — 1 1/2 — 1 3/8 — 1 1/4 — 1 3/8 — 1 1/2 — 1 1/2
70	40BS70	11.430	1 1/4	10.80	— 3/8 — 3/8 — 1 — 1 1/2 — 1 3/8 — 1 1/4 — 1 3/8 — 1 1/2 — 1 1/2
72	40BS72	11.750	1 1/4	11.30	— 3/8 — 3/8 — 1 — 1 1/2 — 1 3/8 — 1 1/4 — 1 3/8 — 1 1/2 — 1 1/2
80	40BS80	13.030	1 1/4	13.20	— 3/8 — 3/8 — 1 — 1 1/2 — 1 3/8 — 1 1/4 — 1 3/8 — 1 1/2 — 1 1/2
84	40BS84	13.660	1 1/4	13.84	— 3/8 — 3/8 — 1 — 1 1/2 — 1 3/8 — 1 1/4 — 1 3/8 — 1 1/2 — 1 1/2
96	40BS96	15.570	1 1/4	17.44	— 1 — 1 1/2 — 1 3/8 — 1 1/4 — 1 3/8 — 1 1/2 — 1 1/2
112	40BS112	18.120	1 1/4	22.45	— 1 — 1 1/2 — 1 3/8 — 1 1/4 — 1 3/8 — 1 1/2 — 1 1/2



**BORED-TO-SIZE**

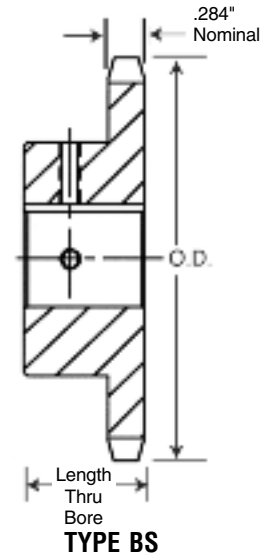

\* Indicates no keyway. (2) 1/4" setscrews only.  
Hub diameters vary to suit different bore sizes.  
NOTE: KEYWAY IS ON CENTER LINE OF TOOTH.



### No. 40-Hardened Teeth — 2 Setscrews — Bored-To-Size

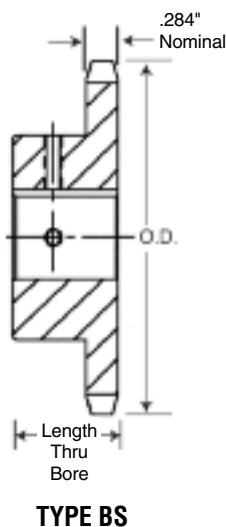

No. Teeth	Catalog Number	Outside Diameter	Length Thru Bore	Weight Lbs. (Approx.)	Stock Finished Bores Includes Keyway and 2 Setscrews
9	40BS9HT	1.670	3/8	0.16	*1/2 — 3/8
10	40BS10HT	1.840	3/8	0.24	*1/2 — 3/8 — 3/4
11	40BS11HT	2.000	3/8	0.28	*1/2 — 3/8 — 3/4 — 7/8
12	40BS12HT	2.170	3/8	0.34	*1/2 — 3/8 — 3/4 — 7/8 — 1
13	40BS13HT	2.330	3/8	0.45	*1/2 — 3/8 — 3/4 — 7/8 — 1
14	40BS14HT	2.490	3/8	0.51	*1/2 — 3/8 — 3/4 — 7/8 — 1 — 1 1/8
15	40BS15HT	2.650	3/8	0.53	*1/2 — 3/8 — 3/4 — 7/8 — 1 — 1 1/8 — 1 3/8 — 1 1/2
16	40BS16HT	2.810	3/8	0.66	3/8 — 3/4 — 7/8 — 1 — 1 1/8 — 1 3/8 — 1 1/2
17	40BS17HT	2.970	1	0.88	3/8 — 3/4 — 7/8 — 1 — 1 1/8 — 1 3/8 — 1 1/2
18	40BS18HT	3.140	1	1.03	3/8 — 3/4 — 7/8 — 1 — 1 1/8 — 1 3/8 — 1 1/2 — 1 3/8 — 1 1/2
19	40BS19HT	3.292	1	1.17	3/8 — 3/4 — 7/8 — 1 — 1 1/8 — 1 3/8 — 1 1/2 — 1 3/8 — 1 1/2
20	40BS20HT	3.460	1	1.33	3/8 — 3/4 — 7/8 — 1 — 1 1/8 — 1 3/8 — 1 1/2 — 1 3/8 — 1 1/2
21	40BS21HT	3.620	1	1.53	3/8 — 3/4 — 7/8 — 1 — 1 1/8 — 1 3/8 — 1 1/2 — 1 3/8 — 1 1/2
22	40BS22HT	3.780	1	1.66	3/8 — 3/4 — 7/8 — 1 — 1 1/8 — 1 3/8 — 1 1/2 — 1 3/8 — 1 1/2
23	40BS23HT	3.940	1	1.92	3/8 — 3/4 — 7/8 — 1 — 1 1/8 — 1 3/8 — 1 1/2 — 1 3/8 — 1 1/2
24	40BS24HT	4.100	1	2.10	3/8 — 3/4 — 7/8 — 1 — 1 1/8 — 1 3/8 — 1 1/2 — 1 3/8 — 1 1/2
25	40BS25HT	4.260	1	2.22	3/4 — 7/8 — 1 — 1 1/8 — 1 3/8 — 1 1/2 — 1 3/8 — 1 1/2
26	40BS26HT	4.420	1	2.34	3/4 — 7/8 — 1 — 1 1/8 — 1 3/8 — 1 1/2 — 1 3/8 — 1 1/2
28	40BS28HT	4.740	1	2.50	3/4 — 7/8 — 1 — 1 1/8 — 1 3/8 — 1 1/2 — 1 3/8 — 1 1/2
30	40BS30HT	5.060	1	2.70	3/4 — 7/8 — 1 — 1 1/8 — 1 3/8 — 1 1/2 — 1 3/8 — 1 1/2

\*Indicates no keyway. (2) 1/4" setscrews only in 1/2" & 3/8" bore at 90°.  
NOTE: KEYWAY IS ON CENTER LINE OF TOOTH.

*Martin* stock hardened teeth sprockets afford longer chain and sprocket life. Hardened teeth on the smaller sprocket of a roller chain drive are recommended if the drive ratio is four to one or greater or if the smaller sprocket has 24 teeth or less and is running at a speed of over 600 R.P.M.

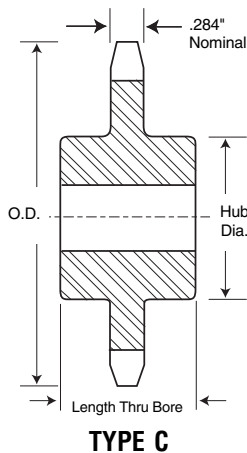

### Single - Type C — Steel

No. Teeth	Catalog Number	Outside Diameter	Bore (inches)		Hub (inches)		Weight Lbs. (Approx.)
			Stock	Rec. Max.	Diameter	Length	
12	40C12	2.170	1/2	1	1 3/8*	1 1/2	0.75
13	40C13	2.330	1/2	1 1/8	1 3/8	1 1/2	0.94
14	40C14	2.490	1/2	1 1/8	1 7/8	1 1/2	0.91
15	40C15	2.650	1/2	1 1/8	1 7/8	1 1/2	1.19
16	40C16	2.810	1/2	1 3/8	2	1 1/2	1.34
17	40C17	2.970	5/8	1 7/8	2 1/8	1 1/2	1.50
18	40C18	3.140	5/8	1 1/2	2 1/8	1 1/2	1.80

\* Has recessed groove in hub for chain clearance.

# No. 40

## 1/2" Pitch

# All Steel Stock Sprockets

# Martin



### Double Single - Type A — Steel

No. Teeth	Catalog Number	Diameters		Type	Min. Bore	Max. Bore	Dimensions				Wt. Lbs. (Approx.)
		Outside Diameter	Pitch Diameter				L	C	E	w Nom.	
15	DS40A15	2.650	2.405	A	1/2	1 1/4	1 13/32	1 1/8	1 1/16	.284	1.2
16	DS40A16	2.810	2.563	A	1/2	1 1/4	1 13/32	1 1/8	2	.284	1.4
17	DS40A17	2.980	2.721	A	1/2	1 1/4	1 13/32	1 1/8	2 1/8	.284	1.6
18	DS40A18	3.140	2.879	A	1/2	1 1/4	1 13/32	1 1/8	2 1/4	.284	1.8
19	DS40A19	3.300	3.038	A	3/8	1 1/2	1 13/32	1 1/8	2 1/2	.284	2.2
20	DS40A20	3.460	3.196	A	5/8	1 3/4	1 13/32	1 1/8	2 5/8	.284	2.6
21	DS40A21	3.620	3.355	A	5/8	1 3/4	1 13/32	1 1/8	2 5/8	.284	2.9
22	DS40A22	3.780	3.513	A	5/8	1 3/4	1 13/32	1 1/8	2 5/8	.284	3.0
23	DS40A23	3.940	3.672	A	5/8	2 1/8	1 13/32	1 1/8	3 3/8	.284	3.5
24	DS40A24	4.100	3.831	A	5/8	2 1/8	1 13/32	1 1/8	3 1/4	.284	4.0
25	DS40A25	4.260	3.989	A	5/8	2 1/4	1 13/32	1 1/8	3 1/8	.284	4.5

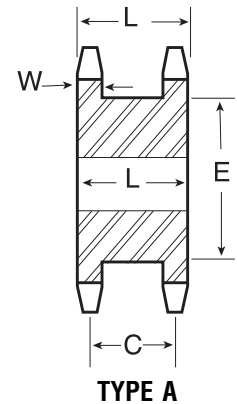

### Double Single - Taper Bushed — Steel

No. Teeth	Catalog Number	Bushing Size	Diameters		Min. Bore	Max. Bore	Type	Dimensions					Wt. Rim Only
			Outside Diameter	Pitch Diameter				L <sub>1</sub>	C	E	L <sub>2</sub>	w Nom.	
18	DS40ATB18H	1215	3.140	2.879	1/2	1 1/4	A	1 13/32	1 1/8	2 1/8	1 1/2	.284	1.0
19	DS40ATB19H	1215	3.300	3.038	1/2	1 1/4	A	1 13/32	1 1/8	2 1/4	1 1/2	.284	1.1
20	DS40ATB20H	1215	3.460	3.196	1/2	1 1/4	A	1 13/32	1 1/8	2 5/8	1 1/2	.284	1.3
21	DS40ATB21H	1615	3.620	3.355	1/2	1 3/4	A	1 13/32	1 1/8	2 5/8	1 1/2	.284	1.3
23	DS40ATB23H	1615	3.940	3.672	1/2	1 3/4	A	1 13/32	1 1/8	3 3/8	1 1/2	.284	1.5
24	DS40ATB24H	1615	4.100	3.831	1/2	1 3/4	A	1 13/32	1 1/8	3 1/4	1 1/2	.284	1.7

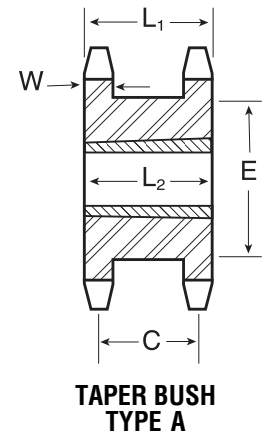

### Double Single - MST® — Steel

No. Teeth	Catalog Number	Bushing Size	Diameters		Min. Bore	Max. Bore	Type	Dimensions					Wt. Rim Only
			Outside Diameter	Pitch Diameter				L <sub>1</sub>	C	E	L <sub>2</sub>	w Nom.	
19	DS40H19H	H	3.300	3.038	3/8	1 1/2	BH	1 13/32	1 1/8	2 1/4	2 1/32	.284	1.5
21	DS40H21H	H	3.620	3.355	3/8	1 1/2	BH	1 13/32	1 1/8	2 5/8	2 1/32	.284	2.0
23	DS40P23H	P1	3.940	3.672	1/2	1 3/4	B	1 13/32	1 1/8	3 3/8	2 9/32	.284	2.3
24	DS40P24H	P1	4.100	3.831	1/2	1 3/4	B	1 13/32	1 1/8	3 1/4	2 5/8	.284	2.5

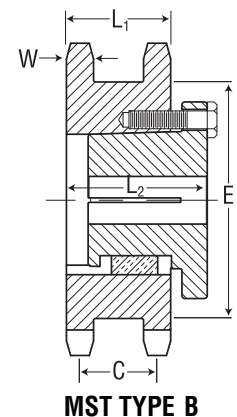



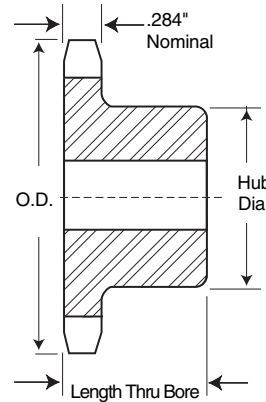

### Alteration Charges

See current discount sheet for alteration charges.

**STAINLESS STEEL**

**TYPE B**

### Single - Type B — Stainless

### Single - Type A

No. Teeth	Catalog Number	Outside Diameter	Type	Bore (inches)		Hub (inches)		Weight Lbs. (Approx.)	Type	Catalog Number	Stock Bore	Weight Lbs. (Approx.)
				Stock	Rec. Max.	Diameter	Length Thru Bore					
8	40B8SS	1.507	B	1/2	1/2	3/32	7/8	0.18				
9	40B9SS	1.840	B	1/2	3/8	1/8	7/8	0.20				
10	40B10SS	1.840	B	1/2	3/8	1 1/8*	7/8	0.28				
11	40B11SS	2.000	B	1/2	13/16	1 1/8*	7/8	0.36				
12	40B12SS	2.170	B	1/2	15/16	1 5/8*	7/8	0.44				
13	40B13SS	2.330	B	1/2	1 1/8	1 1/8	7/8	0.50	A	40A13SS	1/2	0.22
14	40B14SS	2.490	B	1/2	1 1/8	1 1/8	7/8	0.60	A	40A14SS	1/2	0.26
15	40B15SS	2.650	B	1/2	1 1/4	1 1/8	7/8	0.68	A	40A15SS	5/8	0.30
16	40B16SS	2.810	B	5/8	1 1/8	2	7/8	0.82	A	40A16SS	5/8	0.34
17	40B17SS	2.980	B	5/8	1 1/8	2 1/2	1	1.06	A	40A17SS	5/8	0.36
18	40B18SS	3.140	B	5/8	1 1/2	2 1/8	1	1.24	A	40A18SS	5/8	0.44
19	40B19SS	3.300	B	5/8	1 1/2	2 1/2	1	1.42	A	40A19SS	5/8	0.46
20	40B20SS	3.460	B	5/8	1 1/2	2 1/2	1	1.60	A	40A20SS	5/8	0.56
21	40B21SS	3.620	B	5/8	1 1/2	2 1/2	1	1.68	A	40A21SS	5/8	0.58
22	40B22SS	3.780	B	5/8	1 1/2	2 1/2	1	1.81	A	40A22SS	5/8	0.66
23	40B23SS	3.940	B	5/8	2	3	1	2.14	A	40A23SS	5/8	0.72
24	40B24SS	4.100	B	5/8	2 1/4	3 1/4	1	2.46	A	40A24SS	5/8	0.82
25	40B25SS	4.260	B	5/8	2 1/4	3 1/4	1	2.55	A	40A25SS	5/8	0.88
26	40B26SS	4.420	B	5/8	2 1/4	3 1/4	1	2.62	A	40A26SS	19/32	1.31
28	40B28SS	4.740	B	5/8	2 1/4	3 1/4	1	2.75	A	40A28SS	19/32	1.35
30	40B30SS	5.060	B	5/8	2 1/2	3 1/2	1	2.88	A	40A30SS	19/32	1.39
32	40B32SS	5.376	B	5/8	2 1/2	3 1/2	1	3.16	A	40A32SS	19/32	1.48
35	40B35SS	5.860	B	5/8	2 1/2	3 1/2	1	3.32	A	40A35SS	19/32	1.92
36	40B36SS	6.015	B	5/8	2 1/2	3 1/2	1	3.58	A	40A36SS	19/32	1.84
40	40B40SS	6.650	B	3/4	2 1/2	3 1/2	1 1/2	4.28	A	40A40SS	23/32	2.36
45	40B45SS	7.450	B	3/4	2 3/4	3 1/2	1 1/2	4.68	A	40A45SS	23/32	3.13
48	40B48SS	7.928	B	3/4	2 3/4	3 1/2	1 1/2	5.84	A	40A48SS	23/32	3.22
54	40B54SS	8.884	B	3/4	2 3/4	3 1/2	1 1/2	6.42	A	40A54SS	23/32	4.44
60	40B60SS	9.840	B	3/4	2 3/4	3 1/2	1 1/2	7.00	A	40A60SS	23/32	5.50

\* Has recessed groove in hub for chain clearance.

Maximum bores shown will accommodate standard keyseat and setscrew over keyseat. Slightly larger bores are possible with no keyseat, shallow keyseat, or setscrew at angle to keyseat.

Sprockets altered at factory (rebored with keyway and setscrew added) will be supplied with stainless setscrew.

# No. 40

## 1/2" Pitch

# All Steel Stock Sprockets

# Martin

### Single - Type B

### Single - Type A

No. Teeth	Catalog Number	Outside Diameter	Type	Bore (inches)		Hub (inches)		Weight Lbs (Approx.)	Type	Catalog Number	Stock Bore	Weight Lbs. (Approx.)
				Stock	Rec. Max.	Diameter	Length Thru Bore					
8	40B8	1.510	B	1/2	1/2	5/16★	7/8	0.18				
9	40B9	1.670	B	1/2	5/16	1 1/16★	7/8	0.20				
10	40B10	1.840	B	1/2	3/4	1 1/8★	7/8	0.27				
11	40B11	2.000	B	1/2	7/8	1 3/8★	7/8	0.35				
12	40B12	2.170	B	1/2	1	1 1/16★	7/8	0.45	A	40A12	1/2	0.18
13	40B13	2.330	B	1/2	1 1/16	1 1/8	7/8	0.50	A	40A13	1/2	0.22
14	40B14	2.490	B	1/2	1 1/8	1 1/16	7/8	0.59	A	40A14	1/2	0.26
15	40B15	2.650	B	1/2	1 1/4	1 1/8	7/8	0.70	A	40A15	1/2	0.30
16	40B16	2.810	B	5/8	1 1/8	2	7/8	0.79	A	40A16	5/8	0.34
17	40B17	2.980	B	5/8	1 1/16	2 1/8	1	1.04	A	40A17	5/8	0.36
18	40B18	3.140	B	5/8	1 1/8	2 3/8	1	1.22	A	40A18	5/8	0.44
19	40B19	3.300	B	5/8	1 1/4	2 1/2	1	1.43	A	40A19	5/8	0.46
20	40B20	3.460	B	5/8	1 3/8	2 5/8	1	1.56	A	40A20	5/8	0.56
21	40B21	3.620	B	5/8	1 7/8	2 3/4	1	1.73	A	40A21	5/8	0.58
22	40B22	3.780	B	5/8	1 7/8	2 7/8	1	1.96	A	40A22	5/8	0.66
23	40B23	3.940	B	5/8	2	3	1	2.13	A	40A23	5/8	0.72
24	40B24	4.100	B	5/8	2 1/4	3 1/4	1	2.41	A	40A24	5/8	0.82
25	40B25	4.260	B	5/8	2 1/4	3 1/4	1	2.54	A	40A25	5/8	0.88
26	40B26	4.420	B	5/8	2 1/4	3 1/4	1	2.58	A	40A26	5/8	0.94
27	40B27	4.580	B	5/8	2 1/4	3 1/4	1	2.66	A	40A27	5/8	0.98
28	40B28	4.740	B	5/8	2 1/4	3 1/4	1	2.73	A	40A28	5/8	1.10
29	40B29	4.900	B	5/8	2 1/4	3 1/4	1	2.80	A	40A29	19/32	1.22
30	40B30	5.060	B	5/8	2 1/4	3 1/4	1	2.98	A	40A30	19/32	1.26
31	40B31	5.220	B	5/8	2 1/4	3 1/4	1	3.10	A	40A31	19/32	1.40
32	40B32	5.380	B	5/8	2 1/4	3 1/4	1	3.16	A	40A32	19/32	1.48
33	40B33	5.540	B	5/8	2 1/4	3 1/4	1	3.22	A	40A33	19/32	1.56
34	40B34	5.700	B	5/8	2 1/4	3 1/4	1	3.30	A	40A34	19/32	1.64
35	40B35	5.860	B	5/8	2 1/4	3 1/4	1	3.46	A	40A35	19/32	1.70
36	40B36	6.020	B	5/8	2 1/4	3 1/4	1	3.58	A	40A36	19/32	1.84
37	40B37	6.180	B	5/8	2 1/4	3 1/4	1	3.62	A	40A37	19/32	1.92
38	40B38	6.330	B	5/8	2 1/4	3 1/4	1	3.70	A	40A38	19/32	2.00
39	40B39	6.490	B	5/8	2 1/4	3 1/4	1	3.76	A	40A39	19/32	2.02
40	40B40	6.650	B	3/4	2 3/4	3 1/2	1 1/8	4.69	A	40A40	21/32	2.22
41	40B41	6.810	B	3/4	2 3/4	3 1/2	1 1/8	4.76	A	40A41	21/32	2.40
42	40B42	6.970	B	3/4	2 3/4	3 1/2	1 1/8	4.82	A	40A42	21/32	2.52
43	40B43	7.130	B	3/4	2 3/4	3 1/2	1 1/8	5.12	A	40A43	21/32	2.64
44	40B44	7.290	B	3/4	2 3/4	3 1/2	1 1/8	5.15	A	40A44	21/32	2.81
45	40B45	7.450	B	3/4	2 3/4	3 1/2	1 1/8	5.30	A	40A45	21/32	2.90
46	40B46	7.610	B	3/4	2 3/4	3 1/2	1 1/8	5.57	A	40A46	21/32	3.03
47	40B47	7.770	B	3/4	2 3/4	3 1/2	1 1/8	5.44	A	40A47	21/32	3.17
48	40B48	7.930	B	3/4	2 3/4	3 1/2	1 1/8	5.84	A	40A48	21/32	3.31
49	40B49	8.090	B	3/4	2 3/4	3 1/2	1 1/8	5.90	A	40A49	21/32	3.45
50	40B50	8.250	B	3/4	2 3/4	3 1/2	1 1/8	5.96	A	40A50	21/32	3.60
51	40B51	8.410	B	3/4	2 3/4	3 1/2	1 1/8	6.08	A	40A51	21/32	3.75
52	40B52	8.570	B	3/4	2 3/4	3 1/2	1 1/8	6.28	A	40A52	21/32	3.90
53	40B53	8.730	B	3/4	2 3/4	3 1/2	1 1/8	6.33	A	40A53	21/32	4.05
54	40B54	8.890	B	3/4	2 3/4	3 1/2	1 1/8	6.42	A	40A54	21/32	4.44
55	40B55	9.040	B	3/4	2 3/4	3 1/2	1 1/8	6.46	A	40A55	21/32	4.54
56	40B56	9.200	B	3/4	2 3/4	3 1/2	1 1/8	6.89	A	40A56	21/32	4.84
57	40B57	9.360	B	3/4	2 3/4	3 1/2	1 1/8	7.02	A	40A57	21/32	5.00
58	40B58	9.520	B	3/4	2 3/4	3 1/2	1 1/8	7.36	A	40A58	21/32	5.12
59	40B59	9.680	B	3/4	2 3/4	3 1/2	1 1/8	7.45	A	40A59	21/32	5.30
60	40B60	9.840	B	3/4	2 3/4	3 1/2	1 1/8	7.86	A	40A60	21/32	5.48
70	40B70	11.430	B	3/4	2 3/4	4	1 1/4	11.00	A	40A70	21/32	7.24
72	40B72	11.750	B	3/4	2 3/4	4	1 1/4	11.50	A	40A72	21/32	7.56
80	40B80	13.030	B	3/4	2 3/4	4	1 1/4	13.40	A	40A80	21/32	10.20
84	40B84	13.660	B	3/4	2 3/4	4	1 1/4	14.04	A	40A84	21/32	10.07
96	40B96	15.570	B	1	2 3/4	4	1 1/4	17.56	A	40A96	1 1/16	12.15
112	40B112	18.120	B	1	2 3/4	4	1 1/4	22.56	A	40A112	1 1/16	20.00

★ Has recessed groove in hub for chain clearance.

Maximum bores shown will accommodate standard keyseat and setscrew over keyseat. Slightly larger bores are possible with no keyseat, shallow keyseat, or setscrew at angle to keyseat.

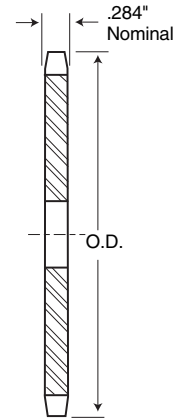

**TYPE A**

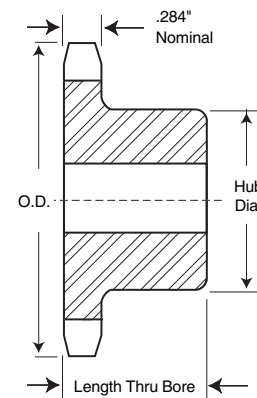

**TYPE B**

#### Alteration Charges

See current discount sheet for alteration charges.

# Martin

## All Steel Stock Sprockets

# No. 40 1/2" Pitch

### Single - Type QD With Hardened Teeth

No. Teeth	Catalog Number
15	40JA15H
16	40JA16H
17	40JA17H
18	40JA18H
19	40JA19H
20	40SH20H
21	40SH21H
22	40SH22H
23	40SH23H
24	40SH24H
25	40SH25H
26	40SH26H
27	40SH27H
28	40SH28H
30	40SH30H

**SABER  
TOOTH®**

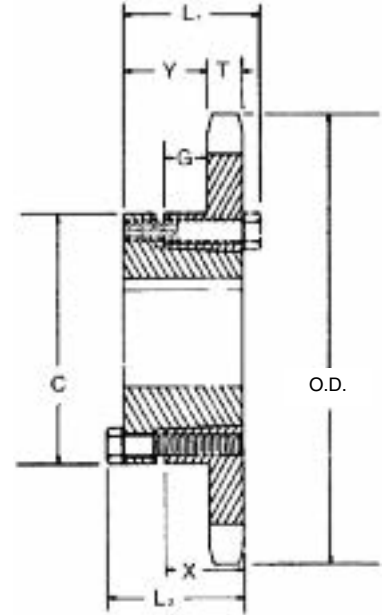

**QD — TYPE B**

### Single - Type QD

No. Teeth	Catalog Number	Bush- ing	Diameters		Type	Max. Bore	Dimensions							Weight Lbs. (Approx.)	
			Outside Diameter	Pitch Diameter			L <sub>1</sub>	L <sub>2</sub>	C	Y	G	X	T	With Hub	Rim Only
15	40JA15	JA	2.650	2.405	B	1 1/4	1 1/8	1 1/8	2 1/16	3/32	1 1/32	5/8	0.284	1.24	0.34
16	40JA16	JA	2.810	2.563	B	1 1/4	1 1/8	1 1/8	2 1/16	3/32	1 1/32	5/8	0.284	1.30	0.40
17	40JA17	JA	2.980	2.721	B	1 1/4	1 1/8	1 1/8	2 1/16	3/32	1 1/32	5/8	0.284	1.38	0.48
18	40JA18	JA	3.140	2.879	B	1 1/4	1 1/8	1 1/8	2 1/16	3/32	1 1/32	5/8	0.284	1.44	0.54
19	40JA19	JA	3.300	3.038	B	1 1/4	1 1/8	1 1/8	2 1/16	3/32	1 1/32	5/8	0.284	1.50	0.60
20	40SH20	SH	3.460	3.196	B	1 1/2	1 1/16	1 1/16	2 1/16	3/32	1 1/32	13/16	0.284	1.76	0.76
21	40SH21	SH	3.620	3.355	B	1 1/2	1 1/16	1 1/16	2 1/16	3/32	1 1/32	13/16	0.284	1.84	0.84
22	40SH22	SH	3.780	3.513	B	1 1/2	1 1/16	1 1/16	2 1/16	3/32	1 1/32	13/16	0.284	1.92	0.92
23	40SH23	SH	3.940	3.672	B	1 1/2	1 1/16	1 1/16	2 1/16	3/32	1 1/32	13/16	0.284	2.14	1.14
24	40SH24	SH	4.100	3.831	B	1 1/2	1 1/16	1 1/16	2 1/16	3/32	1 1/32	13/16	0.284	2.22	1.22
25	40SH25	SH	4.260	3.989	B	1 1/2	1 1/16	1 1/16	2 1/16	3/32	1 1/32	13/16	0.284	2.30	1.30
26	40SH26	SH	4.420	4.148	B	1 1/2	1 1/16	1 1/16	2 1/16	3/32	1 1/32	13/16	0.284	2.44	1.44
27	40SH27	SH	4.580	4.307	B	1 1/2	1 1/16	1 1/16	2 1/16	3/32	1 1/32	13/16	0.284	2.46	1.46
28	40SH28	SH	4.740	4.466	B	1 1/2	1 1/16	1 1/16	2 1/16	3/32	1 1/32	13/16	0.284	2.54	1.54
30	40SH30	SH	5.060	4.783	B	1 1/2	1 1/16	1 1/16	2 1/16	3/32	1 1/32	13/16	0.284	2.72	1.72
32	40SH32	SH	5.380	5.101	B	1 1/2	1 1/16	1 1/16	2 1/16	3/32	1 1/32	13/16	0.284	2.90	1.90
35	40SH35	SH	5.860	5.578	B	1 1/2	1 1/16	1 1/16	3	3/32	1 1/32	13/16	0.284	3.22	2.22
36	40SDS36	SDS	6.020	5.737	B	2	1 1/2	1 1/2	3 3/16	1 1/2	1 1/2	3/4	0.284	3.20	2.20
40	40SDS40	SDS	6.650	6.373	B	2	1 1/2	1 1/2	3 3/16	1 1/2	1 1/2	3/4	0.284	3.72	2.72
42	40SDS42	SDS	6.970	6.691	B	2	1 1/2	1 1/2	3 3/16	1 1/2	1 1/2	3/4	0.284	3.92	2.92
45	40SDS45	SDS	7.450	7.168	B	2	1 1/2	1 1/2	3 3/16	1 1/2	1 1/2	3/4	0.284	4.32	3.32
48	40SDS48	SDS	7.930	7.645	B	2	1 1/2	1 1/2	3 3/16	1 1/2	1 1/2	3/4	0.284	4.70	3.70
54	40SDS54	SDS	8.890	8.599	B	2	1 1/2	1 1/2	3 3/16	1 1/2	1 1/2	3/4	0.284	5.78	4.78
60	40SDS60	SDS	9.840	9.554	B	2	1 1/2	1 1/2	3 3/16	1 1/2	1 1/2	3/4	0.284	6.86	5.86
70	40SK70	SK	11.430	11.145	B	2 1/2	2 1/2	2 1/2	3 3/8	1 1 1/2	1 1/2	1 1/4	0.284	10.68	8.68
72	40SK72	SK	11.750	11.463	B	2 1/2	2 1/2	2 1/2	3 3/8	1 1 1/2	1 1/2	1 1/4	0.284	10.84	8.84
80	40SK80	SK	13.030	12.736	B	2 1/2	2 1/2	2 1/2	3 3/8	1 1 1/2	1 1/2	1 1/4	0.284	13.20	11.20
84	40SK84	SK	13.660	13.372	B	2 1/2	2 1/2	2 1/2	3 3/8	1 1 1/2	1 1/2	1 1/4	0.284	13.56	11.56
96	40SK96	SK	15.570	15.282	B	2 1/2	2 1/2	2 1/2	3 3/8	1 1 1/2	1 1/2	1 1/4	0.284	17.76	15.76
112	40SK112	SK	18.120	17.828	B	2 1/2	2 1/2	2 1/2	3 3/8	1 1 1/2	1 1/2	1 1/4	0.284	22.28	20.28

# No. 40

## 1/2" Pitch

# All Steel Stock Sprockets

# Martin

### Single - Taper Bushed with Hardened Teeth

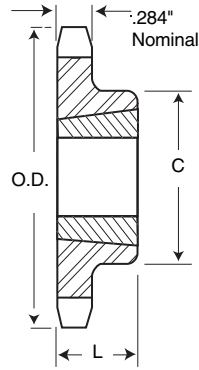

**TAPER BUSHED  
TYPE B**

**SABER  
TOOTH®**

No. Teeth	Catalog Number
14	40BTB14H
15	40BTB15H
16	40BTB16H
17	40BTB17H
18	40BTB18H
19	40BTB19H
20	40BTB20H
21	40BTB21H
22	40BTB22H
23	40BTB23H
24	40BTB24H
25	40BTB25H
26	40BTB26H
28	40BTB28H
30	40BTB30H

### Single - Taper Bushed

No. Teeth	Catalog Number	Bushing	Diameters		Max. Bore	Dimensions		Type	Weight Lbs. (Approx.)	
			Outside Diameter	Pitch Diameter		L	C		Rim Only	Bushing Only
14	40BTB14	1008	2.491	2.247	1	7/8	★1 1/16	B	0.3	0.3
15	40BTB15	1008	2.652	2.405	1	7/8	1 1/16	B	0.4	0.3
16	40BTB16	1008	2.814	2.563	1	7/8	1 1/16	B	0.5	0.3
17	40BTB17	1210	2.975	2.721	1 1/4	1	★2 5/8	B	0.5	0.3
18	40BTB18	1210	3.135	2.879	1 1/4	1	★2 5/16	B	0.6	0.6
19	40BTB19	1210	3.296	3.038	1 1/4	1	2 5/16	B	0.7	0.6
20	40BTB20	1610	3.457	3.196	1 1/2	1	★2 5/8	B	0.7	0.9
21	40BTB21	1610	3.617	3.355	1 1/2	1	2 5/8	B	0.8	0.9
22	40BTB22	1610	3.778	3.513	1 1/2	1	2 5/8	B	0.9	0.9
23	40BTB23	1610	3.938	3.672	1 1/2	1	3 3/16	B	1.0	0.9
24	40BTB24	1610	4.098	3.831	1 1/2	1	3 1/4	B	1.4	0.9
25	40BTB25	1610	4.258	3.989	1 1/2	1	3 1/2	B	1.5	0.9
26	40BTB26	1610	4.418	4.148	1 1/2	1	3 1/2	B	1.7	0.9
28	40BTB28	1610	4.738	4.466	1 1/2	1	3 1/2	B	1.8	0.9
30	40BTB30	1610	5.057	4.783	1 1/2	1	3 1/2	B	1.9	0.9
32	40BTB32	1610	5.377	5.101	1 1/2	1	3 1/2	B	1.9	0.9
35	40BTB35	1610	5.855	5.578	1 1/2	1	3 1/2	B	2.3	0.9
36	40BTB36	1610	6.015	5.737	1 1/2	1	3	B	2.4	0.9
40	40BTB40	1610	6.653	6.373	1 1/2	1	3	B	2.8	0.9
42	40BTB42	1610	6.972	6.691	1 1/2	1	3	B	2.9	0.9
45	40BTB45	1610	7.451	7.168	1 1/2	1	3	B	3.5	0.9
48	40BTB48	1610	7.928	7.645	1 1/2	1	3	B	4.0	0.9
54	40BTB54	1610	8.885	8.599	1 1/2	1	3	B	4.9	0.9
60	40BTB60	1610	9.841	9.554	1 1/2	1	3	B	6.0	0.9
70	40BTB70	2012	11.434	11.145	2	1 1/4	3 9/16	B	8.2	1.7
72	40BTB72	2012	11.752	11.463	2	1 1/4	3 9/16	B	9.0	1.7
80	40BTB80	2012	13.026	12.736	2	1 1/4	3 9/16	B	10.8	1.7
84	40BTB84	2012	13.663	13.372	2	1 1/4	3 9/16	B	11.3	1.7
96	40BTB96	2012	15.573	15.282	2	1 1/4	3 9/16	B	14.6	1.7
112	40BTB112	2517	18.122	17.828	2 1/2	1 3/4	4 1/4	B	20.5	1.7

★ Has recessed groove in hub for chain clearance.

## Single - MST<sup>®</sup> Sprockets

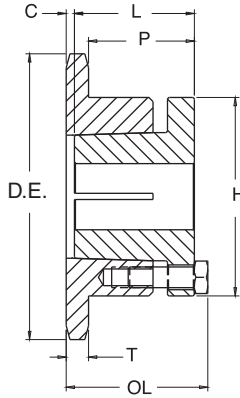

**TYPE 3**

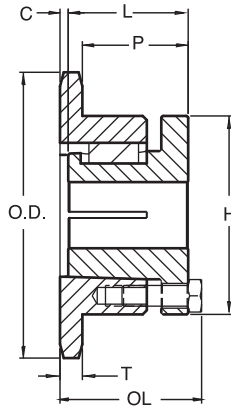

**TYPE 4**

No. Teeth	Catalog Number	Bush- ing	Diameters		Type	Max. Bore	Dimensions						Weight Lbs. (Approx.)	
			Outside Dia.	Pitch Dia.			OL	L	C	H	P	T(nom)	With Hub	Rim Only
15	40H15H	H	2.650	2.405	3	1-1/2	1-19/32	1-1/4	5/32	2-1/2	1-1/8	.284	1.3	0.5
16	40H16H	H	2.810	2.563	3	1-1/2	1-19/32	1-1/4	5/32	2-1/2	1-1/8	.284	1.4	0.6
17	40H17H	H	2.980	2.721	3	1-1/2	1-1/2	1-1/4	1/16	2-1/2	1-1/32	.284	1.4	0.6
18	40H18H	H	3.140	2.879	3	1-1/2	1-1/2	1-1/4	1/16	2-1/2	1-1/32	.284	1.4	0.6
18	40P18H	P1	3.140	2.879	3	1-3/4	2-3/16	1-15/16	0	3	1-21/32	.284	2.7	1.4
19	40H19H	H	3.300	3.038	3	1-1/2	1-1/2	1-1/4	1/16	2 1/2	1-1/32	.284	1.6	0.8
19	40P19H	P1	3.300	3.038	4	1-3/4	2-3/16	1-15/16	0	3	1-21/32	.284	2.6	1.3
20	40H20H	H	3.460	3.196	3	1-1/2	1-1/2	1-1/4	1/16	2-1/2	1-1/32	.284	1.7	0.9
20	40P20H	P1	3.460	3.196	4	1-3/4	2-3/16	1-15/16	0	3	1-21/32	.284	2.6	1.3
21	40H21H	H	3.620	3.355	3	1-1/2	1-1/2	1-1/4	1/16	2-1/2	1-1/32	.284	1.7	0.9
21	40P21H	P1	3.620	3.355	4	1-3/4	2-3/16	1-15/16	0	3	1-21/32	.284	2.8	1.5
22	40H22H	H	3.780	3.513	3	1-1/2	1-1/2	1-1/4	1/16	2-1/2	1-1/32	.284	1.8	1.0
22	40P22H	P1	3.780	3.513	4	1-3/4	2-3/16	1-15/16	0	3	1-21/32	.284	2.9	1.6
23	40H23H	H	3.940	3.672	3	1-1/2	1-1/2	1-1/4	1/16	2-1/2	1-1/32	.284	1.8	1.0
23	40P23H	P1	3.940	3.672	4	1-3/4	2-3/16	1-15/16	0	3	1-21/32	.284	3.0	1.7
24	40H24H	H	4.100	3.831	3	1-1/2	1 1/2	1-1/4	1/16	2-1/2	1-1/32	.284	1.9	1.1
24	40P24H	P1	4.100	3.831	4	1-3/4	2 3/16	1-15/16	0	3	1-21/32	.284	3.1	1.8
25	40H25H	H	4.260	3.989	3	1-1/2	1 1/2	1-1/4	1/16	2-1/2	1-1/32	.284	2.1	1.3
25	40P25H	P1	4.260	3.989	4	1-3/4	2 3/16	1-15/16	0	3	1-21/32	.284	3.2	1.9
26	40H26H	H	4.420	4.148	3	1-1/2	1 1/2	1-1/4	1/16	2-1/2	1-1/32	.284	2.1	1.3
26	40P26H	P1	4.420	4.148	4	1-3/4	2-3/16	1-15/16	0	3	1-21/32	.284	3.2	1.9
27	40H27H	H	4.580	4.307	3	1-1/2	1-1/2	1-1/4	1/16	2-1/2	1-1/32	.284	2.2	1.4
28	40H28H	H	4.740	4.466	3	1-1/2	1-1/2	1-1/4	1/16	2-1/2	1-1/32	.284	2.2	1.4
28	40P28H	P1	4.740	4.466	4	1-3/4	2-3/16	1-15/16	0	3	1-21/32	.284	3.4	2.1
29	40P29H	P1	4.900	4.625	4	1-3/4	2-3/16	1-15/16	0	3	1-21/32	.284	3.6	2.3
30	40H30H	H	5.060	4.783	3	1-1/2	1-1/2	1-1/4	1/16	2-1/2	1-1/32	.284	2.4	1.6
30	40P30H	P1	5.060	4.783	4	1-3/4	2-3/16	1-15/16	0	3	1-21/32	.284	3.6	2.3
31	40P31	P1	5.220	4.942	4	1-3/4	2-3/16	1-15/16	0	3	1-21/32	.284	3.8	2.5
32	40H32H	H	5.380	5.101	3	1-1/2	1-1/2	1-1/4	1/16	2-1/2	1-1/32	.284	2.6	1.8
32	40P32	P1	5.380	5.101	4	1-3/4	2-3/16	1-15/16	0	3	1-21/32	.284	3.9	2.6
33	40H33H	H	5.540	5.260	3	1-1/2	1-1/2	1-1/4	1/16	2-1/2	1-1/32	.284	2.7	1.9
33	40P33	P1	5.540	5.260	4	1-3/4	2-3/16	1-15/16	0	3	1-21/32	.284	3.9	2.6
34	40P34	P1	5.700	5.419	4	1-3/4	2-3/16	1-15/16	0	3	1-21/32	.284	4.1	2.8
35	40H35H	H	5.860	5.578	3	1-1/2	1-1/2	1-1/4	1/16	2-1/2	1-1/32	.284	2.9	2.1
35	40P35	P1	5.860	5.578	4	1-3/4	2-3/16	1-15/16	0	3	1-21/32	.284	4.2	2.9
36	40H36H	H	6.020	5.737	3	1-1/2	1-1/2	1-1/4	1/16	2-1/2	1-1/32	.284	3.1	2.3
36	40P36	P1	6.020	5.737	4	1-3/4	2-3/16	1-15/16	0	3	1-21/32	.284	4.4	3.1
37	40P37	P1	6.180	5.896	4	1-3/4	2-3/16	1-15/16	0	3	1-21/32	.284	4.6	3.3
38	40H38H	H	6.330	6.055	3	1-1/2	1-1/2	1-1/4	1/16	2-1/2	1-1/32	.284	3.4	2.6
38	40P38	P1	6.330	6.055	4	1-3/4	2-3/16	1-15/16	0	3	1-21/32	.284	4.6	3.3
40	40H40H	H	6.650	6.373	3	1-1/2	1-1/2	1-1/4	1/16	2-1/2	1-1/32	.284	3.6	2.8
40	40P40	P1	6.650	6.373	4	1-3/4	2-3/16	1-15/16	0	3	1-21/32	.284	4.8	3.5
41	40P41	P1	6.810	6.532	4	1-3/4	2-3/16	1-15/16	0	3	1-21/32	.284	4.9	3.6
42	40P42	P1	6.970	6.691	4	1-3/4	2-3/16	1-15/16	0	3	1-21/32	.284	5.2	3.9
44	40P44	P1	7.290	7.009	4	1-3/4	2-3/16	1-15/16	0	3	1-21/32	.284	5.3	4.0
45	40P45	P1	7.450	7.168	4	1-3/4	2-3/16	1-15/16	0	3	1-21/32	.284	5.5	4.2
47	40P47	P1	7.770	7.486	4	1-3/4	2-3/16	1-15/16	0	3	1-21/32	.284	5.9	4.6
48	40P48	P1	7.930	7.645	4	1-3/4	2 3/16	1-15/16	0	3	1-21/32	.284	6.1	4.8
50	40P50	P1	8.250	7.963	4	1-3/4	2-3/16	1-15/16	0	3	1-21/32	.284	6.3	5.0
54	40P54	P1	8.890	8.599	4	1-3/4	2-3/16	1-15/16	0	3	1-21/32	.284	6.8	5.5
56	40P56	P1	9.200	8.917	4	1-3/4	2-3/16	1-15/16	0	3	1-21/32	.284	7.2	5.9
60	40P60	P1	9.840	9.554	4	1-3/4	2-3/16	1-15/16	0	3	1-21/32	.284	7.9	6.6
60	40Q60	Q1	9.840	9.554	4	2-11/16	2-25/32	2-1/2	0	4-1/8	2-7/32	.284	12.3	8.8
70	40P70	P1	11.430	11.145	4	1-3/4	2-3/16	1-15/16	0	3	1-21/32	.284	9.9	8.6
70	40Q70	Q1	11.430	11.145	4	2-11/16	2-25/32	2-1/2	0	4-1/8	2-7/32	.284	14.5	11.0
72	40Q72	Q1	11.750	11.463	4	2-11/16	2-25/32	2-1/2	0	4-1/8	2-7/32	.284	14.7	11.2
80	40Q80	Q1	13.030	12.736	4	2-11/16	2-25/32	2-1/2	0	4-1/8	2-7/32	.284	16.6	13.1
84	40Q84	Q1	13.660	13.372	4	2-11/16	2-25/32	2-1/2	0	4-1/8	2-7/32	.284	17.6	14.1
96	40Q96	Q1	15.570	15.281	4	2-11/16	2-25/32	2-1/2	0	4-1/8	2-7/32	.284	16.3	12.8
112	40Q112	Q1	18.120	17.828	4	2-11/16	2-25/32	2-1/2	0	4-1/8	2-7/32	.284	20.8	17.3

Sprockets with "H" suffix have hardened teeth.

# No. 40-2

## 1/2" Pitch

# All Steel Stock Sprockets

# Martin

## Double - Type B

No. Teeth	Catalog Number	Outside Diameter	Type	Bore (inches)		Hub (inches)		Weight Lbs. (Approx.)
				Stock	Rec. Max.	Dia.	Length Thru	
11	D40B11H	2.000	B	1/2	3/4	1 1/16*	1 1/2	0.62
12	D40B12H	2.170	B	1/2	7/8	1 1/8	1 1/2	0.76
13	D40B13H	2.330	B	1/2	1	1 1/8	1 1/2	0.86
14	D40B14H	2.490	B	1/2	1 1/8	1 1/8	1 1/2	1.08
15	D40B15H	2.650	B	1/2	1 1/4	1 1/8	1 1/2	1.24
16	D40B16H	2.810	B	5/8	1 3/8	2	1 1/2	1.42
17	D40B17H	2.980	B	3/4	1 1/2	2 1/8	1 1/2	1.64
18	D40B18H	3.140	B	3/4	1 1/2	2 1/8	1 1/2	1.92
19	D40B19H	3.300	B	3/4	1 3/4	2 1/8	1 1/2	2.22
20	D40B20H	3.460	B	3/4	1 3/4	2 3/8	1 1/2	2.64
21	D40B21H	3.620	B	3/4	1 3/4	2 3/8	1 1/2	2.94
22	D40B22H	3.780	B	3/4	1 3/4	2 3/8	1 1/2	3.18
23	D40B23H	3.940	B	3/4	2	3	1 1/2	3.52
24	D40B24H	4.100	B	3/4	2 1/4	3 1/4	1 1/2	4.04
25	D40B25H	4.260	B	3/4	2 1/4	3 1/4	1 1/2	4.26
26	D40B26	4.420	B	3/4	2 1/4	3 1/4	1 1/2	4.48
30	D40B30	5.060	B	7/8	2 1/4	3 1/4	1 1/2	5.34
35	D40B35	5.860	B	7/8	2 1/4	3 1/4	1 1/2	6.80
36	D40B36	6.020	B	1 1/16	2 1/2	3 3/4	1 1/2	7.20
40	D40B40	6.650	B	1 1/16	2 1/2	3 3/4	1 1/2	9.40
42	D40B42	6.970	B	1 1/16	2 1/2	3 3/4	1 1/2	10.20
45	D40B45	7.450	B	1 1/16	2 1/2	3 3/4	1 1/2	11.36
48	D40B48	7.930	B	1 1/16	2 1/2	3 3/4	1 1/2	12.66
52	D40B52	8.570	B	1 1/16	2 1/2	3 3/4	1 1/2	14.46
54	D40B54	8.890	B	1 1/16	2 1/2	3 3/4	1 1/2	15.48
60	D40B60	9.840	B	1 1/16	2 1/2	3 3/4	1 1/2	18.60
68	D40B68	11.120	B	1 1/16	2 3/4	4 1/4	2 1/2	24.96
72	D40B72	11.750	B	1 1/16	2 3/4	4 1/4	2 1/2	27.88
76	D40B76	12.390	B	1 1/16	2 3/4	4 1/4	2 1/2	30.18
84	D40B84	13.660	B	1 1/16	2 3/4	4 1/4	2 1/2	36.24
95	D40B95	15.410	B	1 1/16	2 3/4	4 1/4	2 1/2	38.84
96	D40B96	15.570	B	1 1/16	2 3/4	4 1/4	2 1/2	39.50
102	D40B102	16.530	B	1 1/16	2 3/4	4 1/4	2 1/2	42.72
112	D40B112	18.120	B	1 1/16	2 3/4	4 1/4	2 1/2	55.54

\* Has recessed groove in hub for chain clearance.

Maximum bores shown will accommodate standard keyseat and setscrew over keyseat. Slightly larger bores are possible with no keyseat, shallow keyseat, or setscrew at angle to keyseat.

NOTE: Double 40 stock sprockets with 25 teeth or less have hardened teeth. As indicated by H suffix.

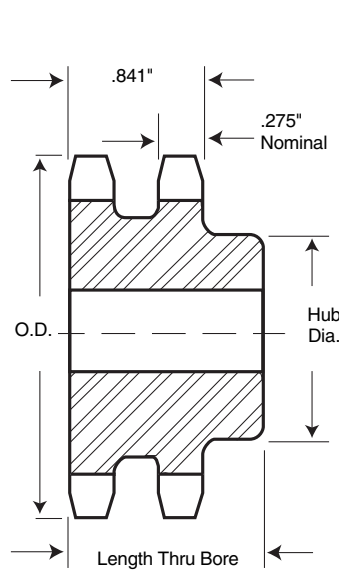

TYPE B

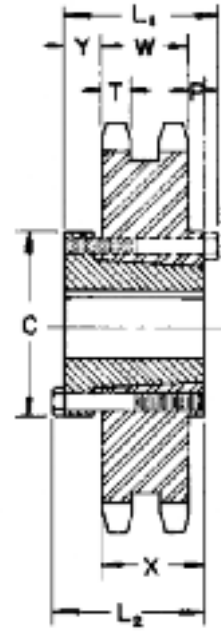

QD — TYPE C

### Alteration Charges

See current discount sheet for alteration charges.

## Double - Type QD

No. Teeth	Catalog Number	Bush-ing	Diameters		Type	Max. Bore	Dimensions								Weight Lbs. (Approx.)	
			Outside Diameter	Pitch Diameter			L <sub>1</sub>	L <sub>2</sub>	C	Y	P	X	T	W	With Hub	Rim Only
36	D40SK36	SK	6.020	5.737	C	2 1/2	2 1/2	2 1/2	3 3/8	5/8	1 1/2	1 1/4	0.275	0.841	6.68	4.68
40	D40SK40	SK	6.650	6.373	C	2 1/2	2 1/2	2 1/2	3 3/8	5/8	1 1/2	1 1/4	0.275	0.841	8.02	6.02
42	D40SK42	SK	6.970	6.691	C	2 1/2	2 1/2	2 1/2	3 3/8	5/8	1 1/2	1 1/4	0.275	0.841	8.82	6.82
45	D40SK45	SK	7.450	7.168	C	2 1/2	2 1/2	2 1/2	3 3/8	5/8	1 1/2	1 1/4	0.275	0.841	9.98	7.98
48	D40SK48	SK	7.930	7.645	C	2 1/2	2 1/2	2 1/2	3 3/8	5/8	1 1/2	1 1/4	0.275	0.841	11.22	9.22
52	D40SK52	SK	8.570	8.281	C	2 1/2	2 1/2	2 1/2	3 3/8	5/8	1 1/2	1 1/4	0.275	0.841	13.04	11.04
54	D40SK54	SK	8.890	8.599	C	2 1/2	2 1/2	2 1/2	3 3/8	5/8	1 1/2	1 1/4	0.275	0.841	14.06	12.06
60	D40SK60	SK	9.840	9.554	C	2 1/2	2 1/2	2 1/2	3 3/8	5/8	1 1/2	1 1/4	0.275	0.841	16.98	14.98
68	D40SF68	SF	11.180	10.826	C	2 1/16	2 1/4	2 1/4	4 1/4	3/4	1 1/2	1 1/4	2.750	0.841	22.72	19.72
72	D40SF72	SF	11.750	11.463	C	2 1/16	2 1/4	2 1/4	4 1/4	3/4	1 1/2	1 1/4	2.750	0.841	24.20	22.20
76	D40SF76	SF	12.390	12.099	C	2 1/16	2 1/4	2 1/4	4 1/4	3/4	1 1/2	1 1/4	2.750	0.841	28.20	25.20
84	D40SF84	SF	13.660	13.372	C	2 1/16	2 1/4	2 1/4	4 1/4	3/4	1 1/2	1 1/4	2.750	0.841	33.64	30.64
95	D40SF95	SF	15.410	15.122	C	2 1/16	2 1/4	2 1/4	4 1/4	3/4	1 1/2	1 1/4	2.750	0.841	40.22	37.22
102	D40SF102	SF	16.530	16.236	C	2 1/16	2 1/4	2 1/4	4 1/4	3/4	1 1/2	1 1/4	2.750	0.841	42.70	39.70
112	D40SF112	SF	18.120	17.828	C	2 1/16	2 1/4	2 1/4	4 1/4	3/4	1 1/2	1 1/4	2.750	0.841	52.60	49.60

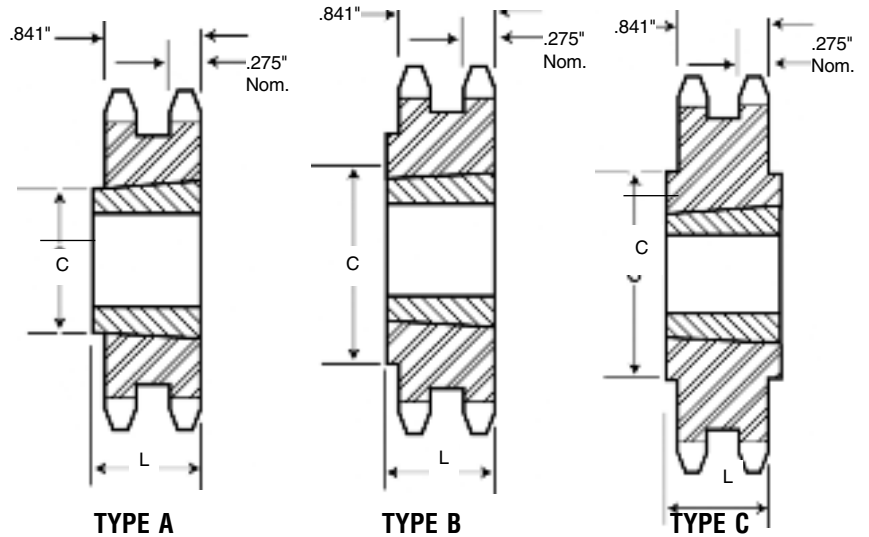

### Double - Taper Bushed

No. Teeth	Catalog Number	Bushing	Diameters		Max. Bore	Dimensions		Type	Weight Lbs. (Approx.)	
			Outside Diameter	Pitch Diameter		L	C		Rim Only	Bushing Only
15	D40ATB15H	1008	2.652	2.405	1	3/8	1 1/4	A	0.5	0.3
16	D40ATB16H	1008	2.814	2.563	1	3/8	1 1/4	A	0.6	0.3
17	D40ATB17H	1008	2.975	2.721	1	3/8	1 1/4	A	0.7	0.3
18	D40BTB18H	1210	3.135	2.879	1 1/4	1	2 5/8	B	0.7	0.6
19	D40BTB19H	1210	3.296	3.038	1 1/4	1	2 1/2	B	0.9	0.6
20	D40BTB20H	1610	3.457	3.196	1 1/2	1	2 5/8	B	0.9	0.9
21	D40BTB21H	1610	3.617	3.355	1 1/2	1	2 3/4	B	1.0	0.9
23	D40BTB23H	1610	3.938	3.672	1 1/2	1	3	B	1.3	0.9
25	D40BTB25H	2012	4.258	3.989	2	1 1/4	3 1/2	B	1.6	1.7
30	D40BTB30	2012	5.057	4.783	2	1 1/4	4 1/4	B	3.4	1.7
36	D40BTB36	2012	6.015	5.737	2	1 1/4	5 1/2	B	5.9	1.7
42	D40CTB42	2517	6.972	6.691	2 1/2	1 3/4	4 1/4	C	7.0	3.5
48	D40CTB48	2517	7.928	7.645	2 1/2	1 3/4	4 1/4	C	9.6	3.5
52	D40CTB52	2517	8.566	8.281	2 1/2	1 3/4	4 1/4	C	11.4	3.5
60	D40CTB60	2517	9.841	9.554	2 1/2	1 3/4	4 1/4	C	15.4	3.5
68	D40CTB68	2517	11.115	10.826	2 1/2	1 3/4	4 1/4	C	20.5	3.5
76	D40CTB76	2517	12.389	12.099	2 1/2	1 3/4	4 1/4	C	25.7	3.5
84	D40CTB84	2517	13.663	13.372	2 1/2	1 3/4	4 1/4	C	31.6	3.5
95	D40CTB95	2517	15.414	15.122	2 1/2	1 3/4	4 1/4	C	34.1	3.5
102	D40CTB102	2517	16.529	16.236	2 1/2	1 3/4	4 1/4	C	36.8	3.5

NOTE: Double 40 stock sprockets with 25 teeth or less have hardened teeth. As indicated by H suffix.

# No. 40-2

## 1/2" Pitch

# MST® Sprockets

# Martin

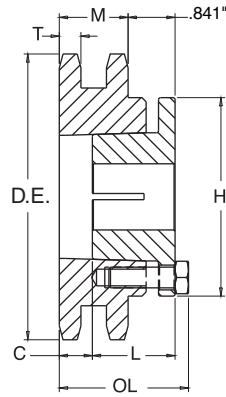

**TYPE 11**

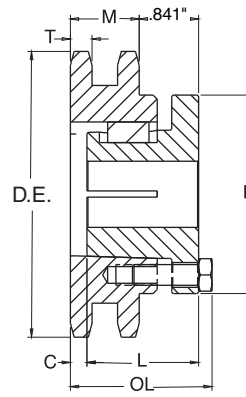

**TYPE 12**

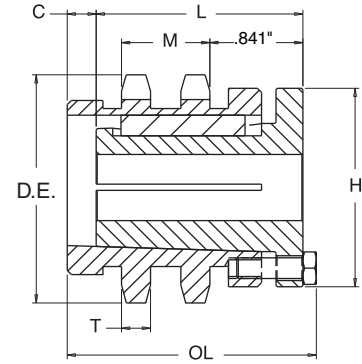

**TYPE 16**

## Double - MST® Sprockets

No. Teeth	Catalog Number	Bush-ing	Diameters		Type	Max. Bore	Dimensions					Weight Lbs. (Approx.)		
			Outside Dia.	Pitch Dia.			OL	L	C	H	P	T(nom)	With Hub	Rim Only
15	D40H15H	H	2.650	2.405	11	1-1/2	2-5/32	1-1/4	23/32	2-1/2	1-1/8	0.275	1.7	0.9
16	D40H16H	H	2.810	2.563	11	1-1/2	2-5/32	1-1/4	23/32	2-1/2	1-1/8	0.275	1.8	1.0
17	D40H17H	H	2.980	2.721	11	1-1/2	2-5/32	1-1/4	23/32	2-1/2	1-1/8	0.275	1.9	1.1
18	D40P18H	P1	3.140	2.879	16	1-3/4	3-3/16	1-15/16	1	3	1-3/8	0.275	3.1	1.8
19	D40P19H	P1	3.300	3.038	12	1-3/4	2-15/32	1-15/16	9/32	3	1-3/8	0.275	2.7	1.4
20	D40P20H	P1	3.460	3.196	12	1-3/4	2-13/32	1-15/16	7/32	3	1-3/8	0.275	2.9	1.6
21	D40P21H	P1	3.620	3.355	12	1-3/4	2-13/32	1-15/16	7/32	3	1-3/8	0.275	3.1	1.8
22	D40P22H	P1	3.780	3.513	12	1-3/4	2-13/32	1-15/16	7/32	3	1-3/8	0.275	3.3	2.0
23	D40P23H	P1	3.940	3.672	12	1-3/4	2-3/16	1-15/16	0	3	1-3/32	0.275	3.3	2.0
24	D40P24H	P1	4.100	3.831	12	1-3/4	2-3/16	1-15/16	0	3	1-3/32	0.275	3.5	2.2
25	D40P25H	P1	4.260	3.989	12	1-3/4	2-3/16	1-15/16	0	3	1-3/32	0.275	3.8	2.5
26	D40P26H	P1	4.420	4.148	12	1-3/4	2-3/16	1-15/16	0	3	1-3/32	0.275	4.0	2.7
28	D40P28H	P1	4.740	4.466	12	1-3/4	2-3/16	1-15/16	0	3	1-3/32	0.275	4.4	3.1
30	D40Q30H	Q1	5.060	4.783	12	2-11/16	2-25/32	2-1/2	0	4-1/8	1-21/32	0.275	7.7	4.2
32	D40Q32H	Q1	5.380	5.101	12	2-11/16	2-25/32	2-1/2	0	4-1/8	1-21/32	0.275	8.8	5.3
35	D40Q35H	Q1	5.860	5.578	12	2-11/16	2-25/32	2-1/2	0	4-1/8	1-21/32	0.275	9.6	6.1
36	D40Q36H	Q1	6.020	5.737	12	2-11/16	2-25/32	2-1/2	0	4-1/8	1-21/32	0.275	10.0	6.5
40	D40Q40H	Q1	6.650	6.373	12	2-11/16	2-25/32	2-1/2	0	4-1/8	1-21/32	0.275	11.4	7.9
42	D40Q42H	Q1	6.970	6.691	12	2-11/16	2-25/32	2-1/2	0	4-1/8	1-21/32	0.275	12.4	8.9
45	D40Q45H	Q1	7.450	7.168	12	2-11/16	2-25/32	2-1/2	0	4-1/8	1-21/32	0.275	13.6	10.1
48	D40Q48H	Q1	7.930	7.645	12	2-11/16	2-25/32	2-1/2	0	4-1/8	1-21/32	0.275	15.3	11.8
52	D40Q52H	Q1	8.570	8.281	12	2-11/16	2-25/32	2-1/2	0	4-1/8	1-21/32	0.275	16.1	12.6
54	D40Q54H	Q1	8.890	8.599	12	2-11/16	2-25/32	2-1/2	0	4-1/8	1-21/32	0.275	17.8	14.3
60	D40Q60H	Q1	9.840	9.554	12	2-11/16	2-25/32	2-1/2	0	4-1/8	1-21/32	0.275	20.9	17.4
68	D40Q68	Q1	11.120	10.826	12	2-11/16	2-25/32	2-1/2	0	4-1/8	1-21/32	0.275	25.0	21.5
72	D40Q72	Q1	11.750	11.463	12	2-11/16	2-25/32	2-1/2	0	4-1/8	1-21/32	0.275	28.5	25.0
76	D40Q76	Q1	12.390	12.099	12	2-11/16	2-25/32	2-1/2	0	4-1/8	1-21/32	0.275	30.4	26.9
84	D40Q84	Q1	13.660	13.372	12	2-11/16	2-25/32	2-1/2	0	4-1/8	1-21/32	0.275	37.6	34.1
95	D40Q95	Q1	15.410	15.122	12	2-11/16	2-25/32	2-1/2	0	4-1/8	1-21/32	0.275	45.5	42.0
96	D40Q96	Q1	15.570	15.281	12	2-11/16	2-25/32	2-1/2	0	4-1/8	1-21/32	0.275	47.6	44.
102	D40Q102	Q1	16.530	16.236	12	2-11/16	2-25/32	2-1/2	0	4-1/8	1-21/32	0.275	52.0	48.5
112	D40Q112	Q1	18.120	17.828	12	2-11/16	2-25/32	2-1/2	0	4-1/8	1-21/32	0.275	64.5	61.0

Sprockets with "H" suffix have hardened teeth.



### Triple - Type B

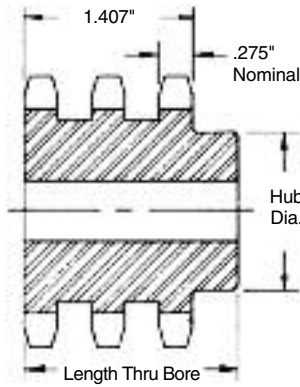

**TYPE B**



**QD — TYPE B**

#### Alteration Charges

See current discount sheet for alteration charges.

No. Teeth	Catalog Number	Outside Diameter	Type	Bore (inches)		Hub (inches)		Weight Lbs. (Approx.)
				Stock	Rec. Max.	Dia.	Length Thru	
11	E40B11H	2.000	B	1/2	3/4	1 1/16*	2 1/2	0.80
12	E40B12H	2.170	B	1/2	15/16	1 1/8*	2 1/2	1.10
13	E40B13H	2.330	B	1/2	1	1 1/8	2 1/2	1.24
14	E40B14H	2.490	B	1/2	1 1/8	1 1/16	2 1/2	1.50
15	E40B15H	2.650	B	1/2	1 1/4	1 3/16	2 1/2	1.76
16	E40B16H	2.810	B	5/8	1 3/8	2	2 1/2	2.04
17	E40B17H	2.980	B	5/8	1 7/8	2 1/8	2 1/2	2.34
18	E40B18H	3.140	B	5/8	2	2 1/8	2 1/2	2.72
19	E40B19H	3.300	B	5/8	2 1/8	2 1/2	2 1/2	3.10
20	E40B20H	3.460	B	5/8	2 1/4	2 3/8	2 1/2	3.72
21	E40B21H	3.620	B	5/8	2 1/2	2 3/4	2 1/2	4.06
22	E40B22H	3.780	B	5/8	2 3/4	2 3/4	2 1/2	4.52
23	E40B23H	3.940	B	5/8	2	3	2 1/2	4.96
24	E40B24H	4.100	B	5/8	2 1/4	3 1/4	2 1/2	5.64
25	E40B25H	4.260	B	5/8	2 1/2	3 3/4	2 1/2	6.02
26	E40B26	4.420	B	5/8	2 1/2	3 3/4	2 1/2	6.36
30	E40B30	5.060	B	7/8	2 1/4	3 3/4	2 1/2	7.84
35	E40B35	5.860	B	7/8	2 1/2	3 3/4	2 1/2	10.30
36	E40B36	6.020	B	15/16	2 1/2	3 3/4	2 1/2	11.72
42	E40B42	6.970	B	15/16	2 1/2	3 3/4	2 1/2	15.36
48	E40B48	7.930	B	15/16	2 1/2	3 3/4	2 1/2	19.36
52	E40B52	8.570	B	15/16	2 1/2	3 3/4	2 1/2	22.44
60	E40B60	9.840	B	15/16	2 1/2	3 3/4	2 1/2	30.02
68	E40B68	11.120	B	1 1/16	2 1/2	4	2 1/2	38.44
72	E40B72	11.750	B	1 1/16	2 1/2	4	2 1/2	42.46
76	E40B76	12.390	B	1 1/16	2 1/2	4	2 1/2	46.90
84	E40B84	13.660	B	1 1/16	2 1/2	4 1/4	2 1/2	57.30
95	E40B95	15.410	B	1 1/16	2 1/2	4 1/4	2 1/2	62.18
102	E40B102	16.530	B	1 1/16	2 1/2	4 1/4	2 1/2	68.40

\* Has recessed groove in hub for chain clearance.

Maximum bores shown will accommodate standard keyseat and setscrew over keyseat. Slightly larger bores are possible with no keyseat, shallow keyseat, or setscrew at angle to keyseat.

NOTE: Triple 40 stock sprockets with 25 teeth or less have hardened teeth. As indicated by H suffix.

### Triple - Type QD

No. Teeth	Catalog Number	Bush-ing	Diameters		Type	Max. Bore	Dimensions							Weight Lbs. (Approx.)	
			Outside Diameter	Pitch Diameter			L <sub>1</sub>	L <sub>2</sub>	C	Y	X	T	W	With Hub	Rim Only
36	E40SK36	SK	6.020	5.737	B	2 5/8	2 1/2	2 1/2	3 3/8	1 5/16	1 1/4	0.275	1.407	8.16	6.16
42	E40SK42	SK	6.970	6.691	B	2 5/8	2 1/2	2 1/2	3 3/8	1 5/16	1 1/4	0.275	1.407	11.92	9.52
48	E40SK48	SK	7.930	7.645	B	2 5/8	2 1/2	2 1/2	3 3/8	1 5/16	1 1/4	0.275	1.407	15.13	13.16
52	E40SK52	SK	8.570	8.281	B	2 5/8	2 1/2	2 1/2	3 3/8	1 5/16	1 1/4	0.275	1.407	18.08	16.08
60	E40SK60	SK	9.840	9.554	B	2 5/8	2 1/2	2 1/2	3 3/8	1 5/16	1 1/4	0.275	1.407	24.60	22.60
68	E40SF68	SF	11.120	10.826	B	2 5/8	2 1/2	2 1/2	4 1/8	1 9/16	1 1/4	0.275	1.407	31.98	29.98
72	E40SF72	SF	11.750	11.463	B	2 5/8	2 1/2	2 1/2	4 1/8	1 9/16	1 1/4	0.275	1.407	37.40	34.40
76	E40SF76	SF	12.390	12.099	B	2 5/8	2 1/2	2 1/2	4 1/8	1 9/16	1 1/4	0.275	1.407	51.92	48.92
84	E40SF84	SF	13.660	13.372	B	2 5/8	2 1/2	2 1/2	4 1/8	1 9/16	1 1/4	0.275	1.407	56.70	53.78
95	E40SF95	SF	15.410	15.122	B	2 5/8	2 1/2	2 1/2	4 1/8	1 9/16	1 1/4	0.275	1.407	58.94	55.94
102	E40SF102	SF	16.530	16.236	B	2 5/8	2 1/2	2 1/2	4 1/8	1 9/16	1 1/4	0.275	1.407	62.24	59.24

# No. 40-3

## 1/2" Pitch

# MST® Sprockets

# Martin

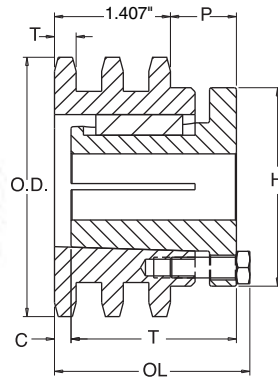

**TYPE 22**

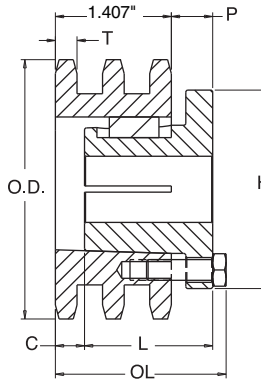

**TYPE 23**

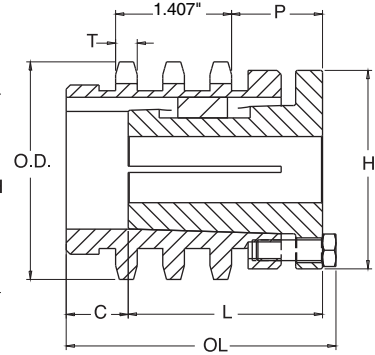

**TYPE 27**

## Triple - MST® Sprockets

No. Teeth	Catalog Number	Bush-ing	Diameters		Type	Max. Bore	Dimensions						Weight Lbs. (Approx.)	
			Outside Dia.	Pitch Dia.			OL	L	C	H	P	T(nom)	With Hub	Rim Only
18	E40P18H	P1	3.140	2.879	27	1-3/4	3-3/4	1-15/16	1 9/16	3	1-3/8	0.275	3.2	1.9
19	E40P19H	P1	3.300	3.038	22	1-3/4	3-1/32	1-15/16	27/32	3	1-3/8	0.275	3.1	1.8
20	E40P20H	P1	3.460	3.196	22	1-3/4	2-31/32	1-15/16	25/32	3	1-5/16	0.275	3.3	2.0
23	E40P23H	P1	3.940	3.672	23	1-3/4	2-9/32	1-15/16	3/32	3	5/8	0.275	3.6	2.3
24	E40P24H	P1	4.100	3.831	23	1-3/4	2-9/32	1-15/16	3/32	3	5/8	0.275	3.9	2.6
25	E40P25H	P1	4.260	3.989	23	1-3/4	2-9/32	1-15/16	3/32	3	5/8	0.275	4.3	3.0
27	E40P27H	P1	4.580	4.307	23	1-3/4	2-9/32	1-15/16	3/32	3	5/8	0.275	4.6	3.3
30	E40Q30H	Q1	5.060	4.783	22	2-11/16	2-25/32	2-1/2	0	4-1/8	1-3/32	0.275	8.0	4.5
35	E40Q35H	Q1	5.860	5.578	22	2-11/16	2-25/32	2-1/2	0	4-1/8	1-3/32	0.275	10.4	6.9
36	E40Q36H	Q1	6.020	5.737	22	2-11/16	2-25/32	2-1/2	0	4-1/8	1-3/32	0.275	11.1	7.6
42	E40Q42H	Q1	6.970	6.691	22	2-11/16	2-25/32	2-1/2	0	4-1/8	1-3/32	0.275	14.6	11.1
48	E40Q48H	Q1	7.930	7.645	22	2-11/16	2-25/32	2-1/2	0	4-1/8	1-3/32	0.275	18.7	15.2
52	E40Q52H	Q1	8.570	8.281	22	2-11/16	2-25/32	2-1/2	0	4-1/8	1-3/32	0.275	22.2	18.7
54	E40Q54H	Q1	8.890	8.599	22	2-11/16	2-25/32	2-1/2	0	4-1/8	1-3/32	0.275	23.4	19.9
60	E40Q60H	Q1	9.840	9.554	22	2-11/16	2-25/32	2-1/2	0	4-1/8	1-3/32	0.275	28.8	25.3
68	E40Q68	Q1	11.120	10.826	22	2-11/16	2-25/32	2-1/2	0	4-1/8	1-3/32	0.275	37.0	33.5
72	E40Q72	Q1	11.750	11.463	22	2-11/16	2-25/32	2-1/2	0	4-1/8	1-3/32	0.275	41.4	37.9
76	E40Q76	Q1	12.390	12.099	22	2-11/16	2-25/32	2-1/2	0	4-1/8	1-3/32	0.275	46.0	42.5
84	E40Q84	Q1	13.660	13.372	22	2-11/16	2-25/32	2-1/2	0	4-1/8	1-3/32	0.275	55.9	52.4
95	E40Q95	Q1	15.410	15.122	22	2-11/16	2-25/32	2-1/2	0	4-1/8	1-3/32	0.275	71.4	67.9
102	E40Q102	Q1	16.530	16.236	22	2-11/16	2-25/32	2-1/2	0	4-1/8	1-3/32	0.275	82.0	78.5

Sprockets with "H" suffix have hardened teeth.

### Single Type BS — 2 Setscrews — Bored-To-Size

No. Teeth	Catalog Number	Outside Diameter	Length Thru Bore	Weight Lbs. (Approx.)	Stock Finished Bores Includes Keyway and 2 Setscrews
9	50BS9	2.090	1	0.30	3/8 — 3/8
10	50BS10	2.300	1	0.30	3/8 — 3/8 — 7/8 — 1 <sup>†</sup>
11	50BS11	2.500	1	0.60	3/8 — 3/8 — 7/8 — 1
12	50BS12	2.710	1	0.70	3/8 — 3/8 — 7/8 — 1 — 1 1/8 — 1 3/8 — 1 1/2
13	50BS13	2.910	1	0.80	3/8 — 3/8 — 7/8 — 1 — 1 1/8 — 1 3/8 — 1 1/2
14	50BS14	3.110	1	1.00	3/8 — 3/8 — 7/8 — 1 — 1 1/8 — 1 3/8 — 1 1/2
15	50BS15	3.320	1	1.20	3/8 — 3/8 — 7/8 — 1 — 1 1/8 — 1 3/8 — 1 1/2 — 1 3/8 — 1 7/8 — 1 1/2
16	50BS16	3.520	1	1.45	3/8 — 3/8 — 7/8 — 1 — 1 1/8 — 1 3/8 — 1 1/2 — 1 3/8 — 1 7/8 — 1 1/2 — 1 3/8
17	50BS17	3.720	1	1.60	3/8 — 3/8 — 7/8 — 1 — 1 1/8 — 1 3/8 — 1 1/2 — 1 3/8 — 1 7/8 — 1 1/2 — 1 3/8
18	50BS18	3.920	1	1.90	3/8 — 3/8 — 7/8 — 1 — 1 1/8 — 1 3/8 — 1 1/2 — 1 3/8 — 1 7/8 — 1 1/2 — 1 3/8
19	50BS19	4.120	1	2.00	3/8 — 3/8 — 7/8 — 1 — 1 1/8 — 1 3/8 — 1 1/2 — 1 3/8 — 1 7/8 — 1 1/2 — 1 3/8
20	50BS20	4.320	1	2.10	3/8 — 7/8 — 1 — 1 1/8 — 1 3/8 — 1 1/2 — 1 3/8 — 1 7/8 — 1 1/2 — 1 3/8
21	50BS21	4.520	1	2.25	3/8 — 7/8 — 1 — 1 1/8 — 1 3/8 — 1 1/2 — 1 3/8 — 1 7/8 — 1 1/2
22	50BS22	4.720	1	2.40	3/8 — 7/8 — 1 — 1 1/8 — 1 3/8 — 1 1/2 — 1 3/8 — 1 7/8 — 1 1/2
23	50BS23	4.920	1	2.50	3/8 — 7/8 — 1 — 1 1/8 — 1 3/8 — 1 1/2 — 1 3/8 — 1 7/8 — 1 1/2
24	50BS24	5.120	1 1/4	3.00	3/8 — 7/8 — 1 — 1 1/8 — 1 3/8 — 1 1/2 — 1 3/8 — 1 7/8 — 1 1/2
25	50BS25	5.320	1 1/4	3.10	3/8 — 7/8 — 1 — 1 1/8 — 1 3/8 — 1 1/2 — 1 3/8 — 1 7/8 — 1 1/2
26	50BS26	5.520	1 1/4	3.30	3/8 — 7/8 — 1 — 1 1/8 — 1 3/8 — 1 1/2 — 1 3/8 — 1 7/8 — 1 1/2
27	50BS27	5.720	1 1/4	3.46	3/8 — 7/8 — 1 — 1 1/8 — 1 3/8 — 1 1/2 — 1 3/8 — 1 7/8 — 1 1/2
28	50BS28	5.920	1 1/4	3.60	3/8 — 7/8 — 1 — 1 1/8 — 1 3/8 — 1 1/2 — 1 3/8 — 1 7/8 — 1 1/2
29	50BS29	6.120	1 1/4	3.78	3/8 — 7/8 — 1 — 1 1/8 — 1 3/8 — 1 1/2 — 1 3/8 — 1 7/8 — 1 1/2
30	50BS30	6.320	1 1/4	3.90	3/8 — 7/8 — 1 — 1 1/8 — 1 3/8 — 1 1/2 — 1 3/8 — 1 7/8 — 1 1/2
31	50BS31	6.520	1 1/4	4.46	3/8 — 7/8 — 1 — 1 1/8 — 1 3/8 — 1 1/2 — 1 3/8 — 1 7/8 — 1 1/2 — — 1 3/8 — 1 5/8
32	50BS32	6.720	1 1/4	4.70	3/8 — 7/8 — 1 — 1 1/8 — 1 3/8 — 1 1/2 — 1 3/8 — 1 7/8 — 1 1/2 — — 1 3/8 — 1 5/8
33	50BS33	6.920	1 1/4	4.92	3/8 — 7/8 — 1 — 1 1/8 — 1 3/8 — 1 1/2 — 1 3/8 — 1 7/8 — 1 1/2 — — 1 3/8 — 1 5/8
34	50BS34	7.120	1 1/4	5.06	3/8 — 7/8 — 1 — 1 1/8 — 1 3/8 — 1 1/2 — 1 3/8 — 1 7/8 — 1 1/2 — — 1 3/8 — 1 5/8
35	50BS35	7.320	1 1/4	5.30	3/8 — 7/8 — 1 — 1 1/8 — 1 3/8 — 1 1/2 — 1 3/8 — 1 7/8 — 1 1/2 — — 1 3/8 — 1 5/8
36	50BS36	7.520	1 1/4	5.50	3/8 — 7/8 — 1 — 1 1/8 — 1 3/8 — 1 1/2 — 1 3/8 — 1 7/8 — 1 1/2 — — 1 3/8 — 1 5/8
37	50BS37	7.720	1 1/4	5.62	3/8 — 7/8 — 1 — 1 1/8 — 1 3/8 — 1 1/2 — 1 3/8 — 1 7/8 — 1 1/2 — — 1 3/8 — 1 5/8
38	50BS38	7.920	1 1/4	5.80	3/8 — 7/8 — 1 — 1 1/8 — 1 3/8 — 1 1/2 — 1 3/8 — 1 7/8 — 1 1/2 — — 1 3/8 — 1 5/8
39	50BS39	8.120	1 1/4	6.02	3/8 — 7/8 — 1 — 1 1/8 — 1 3/8 — 1 1/2 — 1 3/8 — 1 7/8 — 1 1/2 — — 1 3/8 — 1 5/8
40	50BS40	8.320	1 1/4	6.20	3/8 — 7/8 — 1 — 1 1/8 — 1 3/8 — 1 1/2 — 1 3/8 — 1 7/8 — 1 1/2 — — 1 3/8 — 1 5/8
41	50BS41	8.520	1 1/4	6.45	3/8 — 7/8 — 1 — 1 1/8 — 1 3/8 — 1 1/2 — 1 3/8 — 1 7/8 — 1 1/2 — — 1 3/8 — 1 5/8
42	50BS42	8.720	1 1/4	6.68	3/8 — 7/8 — 1 — 1 1/8 — 1 3/8 — 1 1/2 — 1 3/8 — 1 7/8 — 1 1/2 — — 1 3/8 — 1 5/8
43	50BS43	8.910	1 1/4	6.99	3/8 — 7/8 — 1 — 1 1/8 — 1 3/8 — 1 1/2 — 1 3/8 — 1 7/8 — 1 1/2 — — 1 3/8 — 1 5/8
44	50BS44	9.110	1 1/4	7.30	3/8 — 7/8 — 1 — 1 1/8 — 1 3/8 — 1 1/2 — 1 3/8 — 1 7/8 — 1 1/2 — — 1 3/8 — 1 5/8
45	50BS45	9.310	1 1/4	8.00	3/8 — 7/8 — 1 — 1 1/8 — 1 3/8 — 1 1/2 — 1 3/8 — 1 7/8 — 1 1/2 — — 1 3/8 — 1 5/8
46	50BS46	9.510	1 1/4	8.51	1 — 1 1/8 — 1 3/8 — 1 1/2 — 1 3/8 — 1 7/8 — 1 1/2 — — 1 3/8 — 1 5/8
47	50BS47	9.710	1 1/4	8.76	1 — 1 1/8 — 1 3/8 — 1 1/2 — 1 3/8 — 1 7/8 — 1 1/2 — — 1 3/8 — 1 5/8
48	50BS48	9.910	1 1/4	9.03	1 — 1 1/8 — 1 3/8 — 1 1/2 — 1 3/8 — 1 7/8 — 1 1/2 — — 1 3/8 — 1 5/8
49	50BS49	10.110	1 1/4	9.33	1 — 1 1/8 — 1 3/8 — 1 1/2 — 1 3/8 — 1 7/8 — 1 1/2 — — 1 3/8 — 1 5/8
50	50BS50	10.310	1 1/4	9.63	1 — 1 1/8 — 1 3/8 — 1 1/2 — 1 3/8 — 1 7/8 — 1 1/2 — — 1 3/8 — 1 5/8
51	50BS51	10.510	1 1/4	9.81	1 — 1 1/8 — 1 3/8 — 1 1/2 — 1 3/8 — 1 7/8 — 1 1/2 — — 1 3/8 — 1 5/8
52	50BS52	10.710	1 1/4	9.99	1 — 1 1/8 — 1 3/8 — 1 1/2 — 1 3/8 — 1 7/8 — 1 1/2 — — 1 3/8 — 1 5/8
53	50BS53	10.910	1 1/4	10.37	1 — 1 1/8 — 1 3/8 — 1 1/2 — 1 3/8 — 1 7/8 — 1 1/2 — — 1 3/8 — 1 5/8
54	50BS54	11.110	1 1/4	10.75	1 — 1 1/8 — 1 3/8 — 1 1/2 — 1 3/8 — 1 7/8 — 1 1/2 — — 1 3/8 — 1 5/8
55	50BS55	11.310	1 1/4	11.08	1 — 1 1/8 — 1 3/8 — 1 1/2 — 1 3/8 — 1 7/8 — 1 1/2 — — 1 3/8 — 1 5/8
56	50BS56	11.500	1 1/4	11.41	1 — 1 1/8 — 1 3/8 — 1 1/2 — 1 3/8 — 1 7/8 — 1 1/2 — — 1 3/8 — 1 5/8
57	50BS57	11.700	1 1/4	11.75	1 — 1 1/8 — 1 3/8 — 1 1/2 — 1 3/8 — 1 7/8 — 1 1/2 — — 1 3/8 — 1 5/8
58	50BS58	11.900	1 1/4	12.08	1 — 1 1/8 — 1 3/8 — 1 1/2 — 1 3/8 — 1 7/8 — 1 1/2 — — 1 3/8 — 1 5/8
59	50BS59	12.100	1 1/4	12.41	1 — 1 1/8 — 1 3/8 — 1 1/2 — 1 3/8 — 1 7/8 — 1 1/2 — — 1 3/8 — 1 5/8
60	50BS60	12.300	1 1/4	13.50	1 — 1 1/8 — 1 3/8 — 1 1/2 — 1 3/8 — 1 7/8 — 1 1/2 — — 1 3/8 — 1 5/8
70	50BS70	14.290	1 1/4	17.81	1 — 1 1/8 — 1 3/8 — 1 1/2 — 1 3/8 — 1 7/8 — 1 1/2 — — 1 3/8 — 1 5/8
72	50BS72	14.690	1 3/8	19.13	1 — 1 1/8 — 1 3/8 — 1 1/2 — 1 3/8 — 1 7/8 — 1 1/2 — — 1 3/8 — 1 5/8
80	50BS80	16.280	1 3/8	24.39	1 — 1 1/8 — 1 3/8 — 1 1/2 — 1 3/8 — 1 7/8 — 1 1/2 — — 1 3/8 — 1 5/8
84	50BS84	17.080	1 3/8	25.15	1 — 1 1/8 — 1 3/8 — 1 1/2 — 1 3/8 — 1 7/8 — 1 1/2 — — 1 3/8 — 1 5/8
96	50BS96	19.470	1 3/8	32.57	1 — 1 1/8 — 1 3/8 — 1 1/2 — 1 3/8 — 1 7/8 — 1 1/2 — — 1 3/8 — 1 5/8
112	50BS112	22.650	1 3/8	41.65	1 — 1 1/8 — 1 3/8 — 1 1/2 — 1 3/8 — 1 7/8 — 1 1/2 — — 1 3/8 — 1 5/8

<sup>†</sup> Keyway with Setscrew at 90°.

Hub diameters vary to suit different bore sizes.

KEYWAY IS ON CENTER LINE OF TOOTH.

No. 50  
5/8" Pitch

All Steel  
Stock Sprockets

Martin



No. 50 — Hardened Teeth — 2 Setscrews — Bored-To-Size

No. Teeth	Catalog Number	Outside Diameter	Length Thru Bore	Weight Lbs. (Approx.)	Stock Finished Bores Includes Keyway and 2 Setscrews
9	50BS9HT	2.09	1	0.3	$\frac{3}{8}$ — $\frac{3}{8}$
10	50BS10HT	2.30	1	0.3	$\frac{3}{8}$ — $\frac{3}{8}$ — $\frac{7}{8}$ — $\dagger$ 1
11	50BS11HT	2.50	1	0.6	$\frac{3}{8}$ — $\frac{3}{8}$ — $\frac{7}{8}$ — 1
12	50BS12HT	2.71	1	0.7	$\frac{3}{8}$ — $\frac{3}{8}$ — $\frac{7}{8}$ — 1 — $1\frac{1}{8}$ — $1\frac{1}{16}$ — $1\frac{1}{4}$
13	50BS13HT	2.91	1	0.8	$\frac{3}{8}$ — $\frac{3}{8}$ — $\frac{7}{8}$ — 1 — $1\frac{1}{8}$ — $1\frac{1}{16}$ — $1\frac{1}{4}$
14	50BS14HT	3.11	1	1.0	$\frac{3}{8}$ — $\frac{3}{8}$ — $\frac{7}{8}$ — 1 — $1\frac{1}{8}$ — $1\frac{1}{16}$ — $1\frac{1}{4}$
15	50BS15HT	3.32	1	1.2	$\frac{3}{8}$ — $\frac{3}{8}$ — $\frac{7}{8}$ — 1 — $1\frac{1}{8}$ — $1\frac{1}{16}$ — $1\frac{1}{4}$ — $1\frac{1}{8}$ — $1\frac{1}{16}$ — $1\frac{1}{2}$ — $1\frac{1}{8}$
16	50BS16HT	3.52	1	1.5	$\frac{3}{8}$ — $\frac{3}{8}$ — $\frac{7}{8}$ — 1 — $1\frac{1}{8}$ — $1\frac{1}{16}$ — $1\frac{1}{4}$ — $1\frac{1}{8}$ — $1\frac{1}{16}$ — $1\frac{1}{2}$ — $1\frac{1}{8}$ — $1\frac{1}{16}$
17	50BS17HT	3.72	1	1.7	$\frac{3}{8}$ — $\frac{3}{8}$ — $\frac{7}{8}$ — 1 — $1\frac{1}{8}$ — $1\frac{1}{16}$ — $1\frac{1}{4}$ — $1\frac{1}{8}$ — $1\frac{1}{16}$ — $1\frac{1}{2}$ — $1\frac{1}{8}$ — $1\frac{1}{16}$
18	50BS18HT	3.92	1	2.0	$\frac{3}{8}$ — $\frac{3}{8}$ — $\frac{7}{8}$ — 1 — $1\frac{1}{8}$ — $1\frac{1}{16}$ — $1\frac{1}{4}$ — $1\frac{1}{8}$ — $1\frac{1}{16}$ — $1\frac{1}{2}$ — $1\frac{1}{8}$ — $1\frac{1}{16}$
19	50BS19HT	4.12	1	2.2	$\frac{3}{8}$ — $\frac{3}{8}$ — $\frac{7}{8}$ — 1 — $1\frac{1}{8}$ — $1\frac{1}{16}$ — $1\frac{1}{4}$ — $1\frac{1}{8}$ — $1\frac{1}{16}$ — $1\frac{1}{2}$ — $1\frac{1}{8}$ — $1\frac{1}{16}$
20	50BS20HT	4.32	1	2.5	$\frac{3}{8}$ — $\frac{3}{8}$ — $\frac{7}{8}$ — 1 — $1\frac{1}{8}$ — $1\frac{1}{16}$ — $1\frac{1}{4}$ — $1\frac{1}{8}$ — $1\frac{1}{16}$ — $1\frac{1}{2}$ — $1\frac{1}{8}$ — $1\frac{1}{16}$
21	50BS21HT	4.52	1	2.6	$\frac{3}{8}$ — 1 — $1\frac{1}{8}$ — $1\frac{1}{16}$ — $1\frac{1}{4}$ — $1\frac{1}{8}$ — $1\frac{1}{16}$ — $1\frac{1}{2}$ — $1\frac{1}{8}$ — $1\frac{1}{16}$
22	50BS22HT	4.72	1	2.8	$\frac{3}{8}$ — 1 — $1\frac{1}{8}$ — $1\frac{1}{16}$ — $1\frac{1}{4}$ — $1\frac{1}{8}$ — $1\frac{1}{16}$ — $1\frac{1}{2}$ — $1\frac{1}{8}$ — $1\frac{1}{16}$
23	50BS23HT	4.92	1	3.2	$\frac{3}{8}$ — 1 — $1\frac{1}{8}$ — $1\frac{1}{16}$ — $1\frac{1}{4}$ — $1\frac{1}{8}$ — $1\frac{1}{16}$ — $1\frac{1}{2}$ — $1\frac{1}{8}$ — $1\frac{1}{16}$
24	50BS24HT	5.12	1 1/2	4.0	$\frac{3}{8}$ — 1 — $1\frac{1}{8}$ — $1\frac{1}{16}$ — $1\frac{1}{4}$ — $1\frac{1}{8}$ — $1\frac{1}{16}$ — $1\frac{1}{2}$ — $1\frac{1}{8}$ — $1\frac{1}{16}$

† Setscrews at 90° and 180° to key.  
NOTE: KEYWAY IS ON CENTER LINE OF TOOTH.

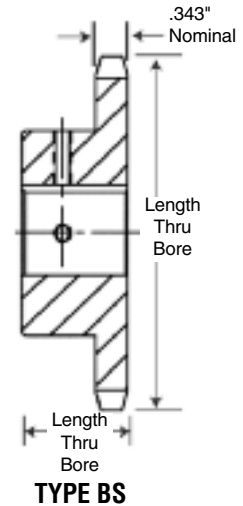

Martin stock hardened teeth sprockets afford longer chain and sprocket life. Hardened teeth on the smaller sprocket of a roller chain drive are recommended if the drive ratio is four to one or greater or if the smaller sprocket has 24 teeth or less and is running at a speed of over 600 R.P.M.

Single - Type C — Steel

No. Teeth	Catalog Number	Outside Diameter	Bore (inches)		Hub (inches)		Weight Lbs. (Approx.)
			Stock	Rec. Max.	Diameter	Length	
12	50C12	2.710	$\frac{3}{8}$	1 1/4	2*	1 1/8	1.25
13	50C13	2.910	$\frac{3}{8}$	1 1/8	1 1/8	1 1/8	1.47
14	50C14	3.110	$\frac{3}{8}$	1 1/8	2 1/8	1 1/8	1.69
15	50C15	3.320	$\frac{3}{8}$	1 1/2	2 3/8	1 1/8	1.94
16	50C16	3.520	$\frac{3}{8}$	1 3/4	2 1/2	1 1/8	2.42
17	50C17	3.720	$\frac{3}{8}$	1 3/4	2 3/4	1 1/8	2.75
18	50C18	3.920	$\frac{3}{8}$	1 3/4	2 7/8	1 1/8	3.25
19	50C19	4.120	$\frac{3}{8}$	2	3 1/8	1 1/8	3.87
20	50C20	4.320	$\frac{3}{8}$	2	3	1 1/8	4.40

\* Has recessed groove in hub for chain clearance.

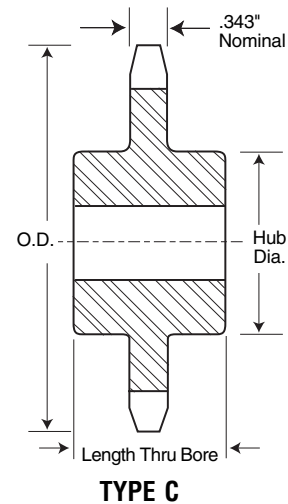

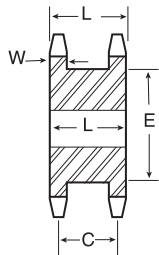

**TYPE A**

### Double Single - Type A — Steel

No. Teeth	Catalog Number	Diameters		Type	Min. Bore	Max. Bore	Dimensions				Wt. Lbs. (Approx.)
		Outside Diameter	Pitch Diameter				L	C	E	w Nom.	
15	DS50A15	3.320	3.006	A	3/8	1 1/2	1 3/32	1 1/16	2 3/8	0.343	2.1
16	DS50A16	3.520	3.204	A	3/8	1 1/16	1 3/32	1 1/16	2 31/64	0.343	2.4
17	DS50A17	3.720	3.401	A	3/8	1 1/8	1 3/32	1 1/16	2 1/16	0.343	2.9
18	DS50A18	3.920	3.599	A	3/8	1 1/4	1 3/32	1 1/16	2 5/16	0.343	3.3
19	DS50A19	4.120	3.797	A	3/8	2 1/16	1 3/32	1 1/16	3 3/16	0.343	3.7
20	DS50A20	4.320	3.995	A	3/8	2 1/8	1 3/32	1 1/16	3 3/8	0.343	4.2
21	DS50A21	4.520	4.194	A	3/8	2 1/4	1 3/32	1 1/16	3 31/64	0.343	4.8
22	DS50A22	4.720	4.392	A	3/8	2 3/8	1 3/32	1 1/16	3 1/16	0.343	5.3
23	DS50A23	4.920	4.590	A	3/8	2 3/4	1 3/32	1 1/16	3 5/16	0.343	5.8
24	DS50A24	5.120	4.788	A	3/8	3	1 3/32	1 1/16	4 3/16	0.343	6.3

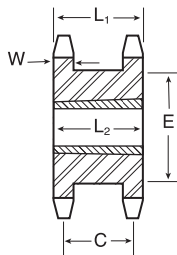

**TAPER BUSH  
TYPE A**

### Double Single - Taper Bushed — Steel

No. Teeth	Catalog Number	Bushing Size	Diameters		Min. Bore	Max. Bore	Type	Dimensions					Wt. Rim Only
			Outside Diameter	Pitch Diameter				L <sub>1</sub>	C	E	L <sub>2</sub>	w Nom.	
16	DS50ATB16H	1215	3.520	3.204	1/2	1 1/8	A	1 21/32	1 1/16	2 31/64	1 1/2	0.343	1.5
17	DS50ATB17H	1615	3.720	3.401	1/2	1 1/4	A	1 21/32	1 1/16	2 11/16	1 1/2	0.343	1.8
18	DS50ATB18H	1615	3.920	3.599	1/2	1 1/2	A	1 21/32	1 1/16	2 5/8	1 1/2	0.343	2.2
19	DS50ATB19H	1615	4.120	3.797	1/2	1 3/4	A	1 21/32	1 1/16	3 1/8	1 1/2	0.343	2.7
20	DS50ATB20H	1615	4.320	3.995	1/2	2	A	1 21/32	1 1/16	3 3/8	1 1/2	0.343	5.0
21	DS50ATB21H	2012	4.520	4.194	1/2	2 1/8	A	1 21/32	1 1/16	3 31/64	1 1/4	0.343	3.3
23	DS50ATB23H	2012	4.920	4.590	1/2	2 1/2	A	1 21/32	1 1/16	3 5/8	1 1/4	0.343	3.7
24	DS50ATB24H	2012	5.120	4.788	1/2	3	A	1 21/32	1 1/16	4 3/16	1 1/4	0.343	4.1

Sprockets with "H" suffix have hardened teeth.

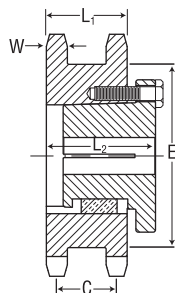

**MST  
TYPE B**

### Double Single- MST® — Steel

No. Teeth	Catalog Number	Bushing Size	Diameters		Min. Bore	Max. Bore	Type	Dimensions					Wt. Rim Only
			Outside Diameter	Pitch Diameter				L <sub>1</sub>	C	E	L <sub>2</sub>	w Nom.	
17	DS50H17H	H	3.720	3.401	3/8	1 1/2	BH	1 21/32	1 1/16	2 11/16	2 3/8	0.343	2.3
19	DS50P19H	P1	4.120	3.797	1/2	1 3/4	B	1 21/32	1 1/16	3 3/8	2 17/32	0.343	2.8
21	DS50P21H	P1	4.520	4.194	1/2	2	B	1 21/32	1 1/16	3 31/64	2 17/32	0.343	3.8
23	DS50P23H	P1	4.920	4.590	1/2	2 1/4	B	1 21/32	1 1/16	3 5/8	2 17/32	0.343	4.6
24	DS50P24H	P1	5.120	4.788	1/2	2 3/4	B	1 21/32	1 1/16	4 3/16	2 17/32	0.343	5.0

Sprockets with "H" suffix have hardened teeth.

No. 50  
5/8" Pitch

# Stainless Steel Stock Sprockets

*Martin*



STAINLESS STEEL

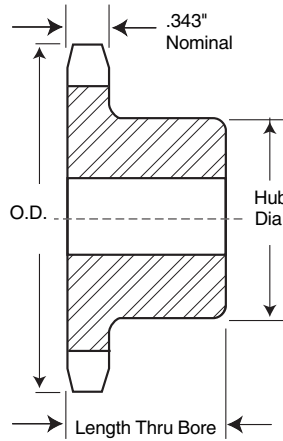

TYPE B

**Alteration Charges**

See current discount sheet for alteration charges.

## Single - Type B — Stainless

## Single - Type A

No. Teeth	Catalog Number	Outside Diameter	Type	Bore (inches)		Hub (inches)		Weight Lbs. (Approx.)	Type	Catalog Number	Stock Bore	Lbs. (Approx.)
				Stock	Rec. Max.	Diameter	Length Thru					
8	50B8SS	1.884	B	5/8	5/8	1 1/8	1	0.25				
9	50B9SS	2.093	B	5/8	3/4	1 1/8	1	0.36				
10	50B10SS	2.300	B	5/8	7/8	1 1/8*	1	0.50				
11	50B11SS	2.500	B	5/8	1	1 1/8*	1	0.60				
12	50B12SS	2.710	B	5/8	1 1/4	1 5/8*	1	0.70				
13	50B13SS	2.910	B	5/8	1 1/8	1 7/8	1	0.80	A	50A13SS	5/8	0.42
14	50B14SS	3.110	B	5/8	1 1/8	2 1/8	1	1.00	A	50A14SS	5/8	0.50
15	50B15SS	3.320	B	5/8	1 1/2	2 1/8	1	1.30	A	50A15SS	5/8	0.54
16	50B16SS	3.520	B	5/8	1 3/4	2 1/8	1	1.50	A	50A16SS	5/8	0.68
17	50B17SS	3.720	B	5/8	1 7/8	2 1/8	1	1.80	A	50A17SS	5/8	0.76
18	50B18SS	3.920	B	5/8	1 7/8	2 1/8	1	2.00	A	50A18SS	5/8	0.86
19	50B19SS	4.120	B	5/8	1 3/4	2 1/2	1	2.23	A	50A19SS	5/8	0.94
20	50B20SS	4.320	B	5/8	1 3/4	2 1/2	1	2.30	A	50A20SS	3/4	1.06
21	50B21SS	4.520	B	5/8	2	3	1	2.42	A	50A21SS	21/32	1.40
22	50B22SS	4.720	B	5/8	2	3	1	2.54	A	50A22SS	21/32	1.60
23	50B23SS	4.920	B	5/8	2	3	1	2.67	A	50A23SS	21/32	1.70
24	50B24SS	5.120	B	5/8	2	3	1 1/4	3.38	A	50A24SS	21/32	1.80
25	50B25SS	5.320	B	5/8	2	3	1 1/4	3.42	A	50A25SS	21/32	1.90
26	50B26SS	5.520	B	5/8	2	3	1 1/4	3.57	A	50A26SS	21/32	1.70
28	50B28SS	5.920	B	5/8	2	3	1 1/4	3.88	A	50A28SS	21/32	2.50
30	50B30SS	6.320	B	5/8	2 1/4	3 1/4	1 1/4	4.54	A	50A30SS	21/32	2.70
32	50B32SS	6.721	B	5/8	2 1/4	3 1/4	1 1/4	4.96	A	50A32SS	21/32	2.72
35	50B35SS	7.320	B	5/8	2 1/4	3 1/4	1 1/4	5.44	A	50A35SS	21/32	3.70
36	50B36SS	7.519	B	5/8	2 1/4	3 1/4	1 1/4	5.64	A	50A36SS	21/32	3.82
40	50B40SS	8.320	B	5/8	2 1/4	3 1/4	1 1/4	6.50	A	50A40SS	21/32	4.70
45	50B45SS	9.310	B	5/8	2 1/2	3 1/4	1 1/4	8.50	A	50A45SS	21/32	6.00
48	50B48SS	9.911	B	1	2 1/2	3 1/4	1 1/4	9.28	A	50A46SS	19/16	6.58
54	50B54SS	11.106	B	1	2 1/2	3 1/4	1 1/4	11.00	A	50A54SS	19/16	8.30
60	50B60SS	12.300	B	1	2 1/2	3 1/4	1 1/4	14.00	A	50A60SS	19/16	10.80

\* Has recessed groove in hub for chain clearance.

Maximum bores shown will accommodate standard keyseat and setscrew over keyseat. Slightly larger bores are possible with no keyseat, shallow keyseat, or setscrew at angle to keyseat.

Sprockets altered at factory (rebored with keyway and setscrew added) will be supplied with stainless setscrew.

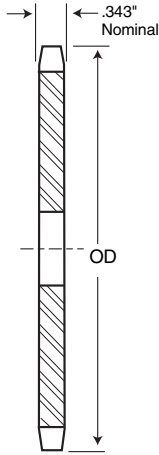

TYPE A

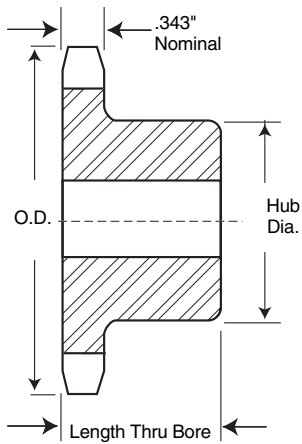

TYPE B

### Alteration Charges

See current discount sheet for alteration charges.

### Single - Type B

### Single - Type A

No. Teeth	Catalog Number	Outside Diameter	Type	Bore (inches)		Hub (inches)		Weight Lbs (Approx.)	Type	Catalog Number	Stock Bore	Weight Lbs. (Approx.)
				Stock	Rec. Max.	Diameter	Length Thru					
8	50B8	1.880	B	%	%	1 1/8★	1	0.25				
9	50B9	2.090	B	%	%	1 3/8★	1	0.36				
10	50B10	2.300	B	%	7/8	1 1/2★	1	0.48				
11	50B11	2.500	B	%	1	1 3/4★	1	0.64				
12	50B12	2.710	B	%	1 1/4	1 5/8★	1	0.83	A	50A12	%	0.34
13	50B13	2.910	B	%	1 1/2	1 3/4	1	0.88	A	50A13	%	0.42
14	50B14	3.110	B	%	1 5/8	2 1/8	1	1.13	A	50A14	%	0.50
15	50B15	3.320	B	%	1 3/4	2 1/4	1	1.34	A	50A15	%	0.54
16	50B16	3.520	B	%	1 7/8	2 3/8	1	1.51	A	50A16	%	0.68
17	50B17	3.720	B	%	2	2 1/4	1	1.74	A	50A17	%	0.76
18	50B18	3.920	B	%	2 1/8	2 3/8	1	2.00	A	50A18	%	0.86
19	50B19	4.120	B	%	2 1/4	3	1	2.22	A	50A19	%	0.94
20	50B20	4.320	B	%	2 3/8	3 1/8	1	2.28	A	50A20	3/4	1.06
21	50B21	4.520	B	%	2 1/2	3 1/4	1	2.40	A	50A21	3/4	1.12
22	50B22	4.720	B	%	2 3/4	3 3/8	1	2.56	A	50A22	3/4	1.30
23	50B23	4.920	B	3/4	2	3	1	2.66	A	50A23	3/4	1.44
24	50B24	5.120	B	3/4	2	3	1 1/4	3.30	A	50A24	2 3/8	1.50
25	50B25	5.320	B	3/4	2	3	1 1/2	3.40	A	50A25	2 3/8	1.62
26	50B26	5.520	B	3/4	2	3	1 3/4	3.44	A	50A26	2 3/8	1.72
27	50B27	5.720	B	3/4	2	3	1 7/8	3.74	A	50A27	2 3/8	1.96
28	50B28	5.920	B	3/4	2	3	2	3.80	A	50A28	2 3/8	2.04
29	50B29	6.120	B	3/4	2	3	2 1/4	4.06	A	50A29	2 3/8	2.36
30	50B30	6.320	B	3/4	2 1/4	3 1/4	1 1/4	4.56	A	50A30	2 3/8	2.54
31	50B31	6.520	B	3/4	2 3/8	3 3/8	1 1/2	4.74	A	50A31	2 3/8	2.80
32	50B32	6.720	B	3/4	2 1/2	3 1/2	1 3/4	4.96	A	50A32	2 3/8	2.72
33	50B33	6.920	B	3/4	2 3/4	3 3/4	1 3/4	5.20	A	50A33	2 3/8	3.14
34	50B34	7.120	B	3/4	2 3/4	3 3/4	1 3/4	5.14	A	50A34	2 3/8	3.20
35	50B35	7.320	B	3/4	2 3/4	3 3/4	1 3/4	5.44	A	50A35	2 3/8	3.34
36	50B36	7.520	B	3/4	2 3/4	3 3/4	1 3/4	5.64	A	50A36	2 3/8	3.82
37	50B37	7.720	B	3/4	2 3/4	3 3/4	1 3/4	5.90	A	50A37	2 3/8	3.98
38	50B38	7.920	B	3/4	2 3/4	3 3/4	1 3/4	6.08	A	50A38	2 3/8	4.14
39	50B39	8.120	B	3/4	2 3/4	3 3/4	1 3/4	6.30	A	50A39	2 3/8	4.42
40	50B40	8.320	B	3/4	2 3/4	3 3/4	1 3/4	6.50	A	50A40	2 3/8	4.46
41	50B41	8.520	B	3/4	2 3/4	3 3/4	1 3/4	6.64	A	50A41	2 3/8	4.86
42	50B42	8.720	B	3/4	2 3/4	3 3/4	1 3/4	6.96	A	50A42	2 3/8	4.98
43	50B43	8.910	B	3/4	2 3/4	3 3/4	1 3/4	7.06	A	50A43	2 3/8	5.24
44	50B44	9.110	B	3/4	2 3/4	3 3/4	1 3/4	7.58	A	50A44	2 3/8	5.42
45	50B45	9.310	B	3/4	2 3/4	3 3/4	1 3/4	8.58	A	50A45	2 3/8	5.92
46	50B46	9.510	B	1	2 1/2	3 3/4	1 3/4	8.22	A	50A46	1 5/8	6.42
47	50B47	9.710	B	1	2 1/2	3 3/4	1 3/4	8.48	A	50A47	1 5/8	6.50
48	50B48	9.910	B	1	2 1/2	3 3/4	1 3/4	9.28	A	50A48	1 5/8	6.58
49	50B49	10.110	B	1	2 1/2	3 3/4	1 3/4	9.22	A	50A49	1 5/8	7.06
50	50B50	10.310	B	1	2 1/2	3 3/4	1 3/4	9.88	A	50A50	1 5/8	7.10
51	50B51	10.510	B	1	2 1/2	3 3/4	1 3/4	9.70	A	50A51	1 5/8	7.32
52	50B52	10.710	B	1	2 1/2	3 3/4	1 3/4	10.24	A	50A52	1 5/8	7.98
53	50B53	10.910	B	1	2 1/2	3 3/4	1 3/4	10.48	A	50A53	1 5/8	8.08
54	50B54	11.110	B	1	2 1/2	3 3/4	1 3/4	11.00	A	50A54	1 5/8	8.30
55	50B55	11.310	B	1	2 1/2	3 3/4	1 3/4	10.93	A	50A55	1 5/8	8.56
56	50B56	11.500	B	1	2 1/2	3 3/4	1 3/4	11.50	A	50A56	1 5/8	8.90
57	50B57	11.700	B	1	2 1/2	3 3/4	1 3/4	12.00	A	50A57	1 5/8	9.38
58	50B58	11.900	B	1	2 1/2	3 3/4	1 3/4	11.82	A	50A58	1 5/8	10.30
59	50B59	12.100	B	1	2 1/2	3 3/4	1 3/4	12.32	A	50A59	1 5/8	10.50
60	50B60	12.300	B	1	2 1/2	3 3/4	1 3/4	13.00	A	50A60	1 5/8	10.80
70	50B70	14.290	B	1	2 3/4	4 1/4	1 3/4	18.16	A	50A70	1 5/8	14.00
72	50B72	14.690	B	1	2 3/4	4 1/4	1 3/4	19.48	A	50A72	1 5/8	15.24
76	50B76	15.486	B	1	2 3/4	4 1/4	1 3/4	21.00	A	50A76	1 5/8	20.08
80	50B80	16.280	B	1	2 3/4	4 1/4	1 3/4	24.74	A	50A80	1 5/8	21.00
84	50B84	17.080	B	1	2 3/4	4 1/4	1 3/4	25.50	A	50A84	1 5/8	22.08
95	50B95	19.270	B	1	2 3/4	4 1/4	1 3/4	32.00	A	50A95	1 5/8	27.00
96	50B96	19.470	B	1	2 3/4	4 1/4	1 3/4	32.92	A	50A96	1 5/8	27.40
112	50B112	22.650	B	1	2 3/4	4 1/4	1 3/4	42.00	A	50A112	1 5/8	37.70

★ Has recessed groove in hub for chain clearance.

Maximum bores shown will accommodate standard keyseat and setscrew over keyseat. Slightly larger bores are possible with no keyseat, shallow keyseat, or setscrew at angle to keyseat.

No. 50  
5/8" Pitch

All Steel  
Stock Sprockets

Martin

Single - Type QD With Hardened Teeth

No. Teeth	Catalog Number
12	50JA12H
13	50JA13H
14	50JA14H
15	50JA15H
16	50JA16H
17	50SH17H
18	50SH18H
19	50SH19H
20	50SDS20H
21	50SDS21H
22	50SDS22H
23	50SDS23H
24	50SDS24H
25	50SDS25H
26	50SDS26H
27	50SDS27H
28	50SDS28H
30	50SDS30H

S  
A  
B  
E  
R  
T  
O  
O  
T  
H<sup>®</sup>

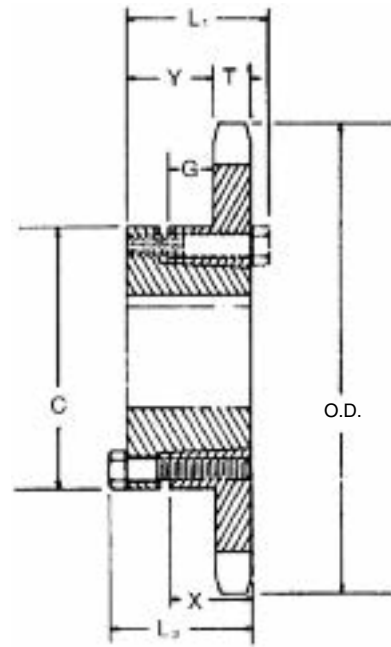

QD — TYPE B

Single - Type QD

No. Teeth	Catalog Number	Bush- ing	Diameters		Type	Max. Bore	Dimensions							Weight (Approx.)	
			Outside Diameter	Pitch Diameter			L <sub>1</sub>	L <sub>2</sub>	C	Y	G	X	T	With Hub	Rim Only
12	50JA12	JA	2.710	2.415	B	1/4	1 1/8	1 1/8	2 1/16	2 1/32	3/32	5/8	0.343	1.24	0.34
13	50JA13	JA	2.910	2.612	B	1/4	1 1/8	1 1/8	2 1/16	2 1/32	3/32	5/8	0.343	1.30	0.40
14	50JA14	JA	3.110	2.803	B	1/4	1 1/8	1 1/8	2 1/16	2 1/32	3/32	5/8	0.343	1.45	0.52
15	50JA15	JA	3.320	3.006	B	1/4	1 1/8	1 1/8	2 1/16	2 1/32	3/32	5/8	0.343	1.50	0.60
16	50JA16	JA	3.520	3.204	B	1/4	1 1/8	1 1/8	2 1/16	2 1/32	3/32	5/8	0.343	1.58	0.68
17	50SH17	SH	3.720	3.401	B	1/2	1 1/16	1 1/8	2 1/16	2 1/32	1/16	1 1/16	0.343	1.84	0.84
18	50SH18	SH	3.920	3.599	B	1/2	1 1/16	1 1/8	2 1/16	2 1/32	1/16	1 1/16	0.343	2.04	1.04
19	50SH19	SH	4.120	3.797	B	1/2	1 1/16	1 1/8	2 1/16	2 1/32	1/16	1 1/16	0.343	2.24	1.24
20	50SDS20	SDS	4.320	3.995	B	2	1 1/2	1 1/2	3 3/16	3 1/32	1/32	3/4	0.343	2.20	1.20
21	50SDS21	SDS	4.520	4.194	B	2	1 1/2	1 1/2	3 3/16	3 1/32	1/32	3/4	0.343	2.32	1.32
22	50SDS22	SDS	4.720	4.392	B	2	1 1/2	1 1/2	3 3/16	3 1/32	1/32	3/4	0.343	2.48	1.42
23	50SDS23	SDS	4.920	4.590	B	2	1 1/2	1 1/2	3 3/16	3 1/32	1/32	3/4	0.343	2.58	1.58
24	50SDS24	SDS	5.120	4.788	B	2	1 1/2	1 1/2	3 3/16	3 1/32	1/32	3/4	0.343	2.70	1.70
25	50SDS25	SDS	5.320	4.987	B	2	1 1/2	1 1/2	3 3/16	3 1/32	1/32	3/4	0.343	2.86	1.86
26	50SDS26	SDS	5.520	5.185	B	2	1 1/2	1 1/2	3 3/16	3 1/32	1/32	3/4	0.343	3.00	2.00
27	50SDS27	SDS	5.720	5.384	B	2	1 1/2	1 1/2	3 3/16	3 1/32	1/32	3/4	0.343	3.12	2.12
28	50SDS28	SDS	5.920	5.582	B	2	1 1/2	1 1/2	3 3/16	3 1/32	1/32	3/4	0.343	3.32	2.32
30	50SDS30	SDS	6.320	5.979	B	2	1 1/2	1 1/2	3 3/16	3 1/32	1/32	3/4	0.343	3.64	2.64
32	50SDS32	SDS	6.720	6.376	B	2	1 1/2	1 1/2	3 3/16	3 1/32	1/32	3/4	0.343	3.98	2.98
35	50SDS35	SDS	7.320	6.972	B	2	1 1/2	1 1/2	3 3/16	3 1/32	1/32	3/4	0.343	4.62	3.62
36	50SDS36	SDS	7.520	7.171	B	2	1 1/2	1 1/2	3 3/16	3 1/32	1/32	3/4	0.343	4.64	3.64
40	50SDS40	SDS	8.320	7.966	B	2	1 1/2	1 1/2	3 3/16	3 1/32	1/32	3/4	0.343	5.74	4.74
42	50SDS42	SDS	8.720	8.363	B	2	1 1/2	1 1/2	3 3/16	3 1/32	1/32	3/4	0.343	6.40	5.40
45	50SDS45	SDS	9.310	8.960	B	2	1 1/2	1 1/2	3 3/16	3 1/32	1/32	3/4	0.343	6.90	5.90
48	50SDS48	SDS	9.910	9.556	B	2	1 1/2	1 1/2	3 3/16	3 1/32	1/32	3/4	0.343	7.66	6.66
54	50SK54	SK	11.110	10.749	B	2 1/2	2 1/2	2 1/2	3 3/16	1 1/32	2/32	1 1/4	0.343	11.68	9.68
60	50SK60	SK	12.300	11.942	B	2 1/2	2 1/2	2 1/2	3 3/16	1 1/32	2/32	1 1/4	0.343	13.88	11.88
70	50SK70	SK	14.290	13.931	B	2 1/2	2 1/2	2 1/2	3 3/16	1 1/32	2/32	1 1/4	0.343	17.52	15.52
72	50SK72	SK	14.690	14.329	B	2 1/2	2 1/2	2 1/2	3 3/16	1 1/32	2/32	1 1/4	0.343	18.44	16.44
80	50SF80	SF	16.280	15.920	B	2 1/16	2 1/4	2 1/4	4 1/8	1 2/32	2/32	1 1/4	0.343	22.90	19.90
84	50SF84	SF	17.080	16.715	B	2 1/16	2 1/4	2 1/4	4 1/8	1 2/32	2/32	1 1/4	0.343	25.98	22.98
96	50SF96	SF	19.470	19.102	B	2 1/16	2 1/4	2 1/4	4 1/8	1 2/32	2/32	1 1/4	0.343	32.88	29.88
112	50SF112	SF	22.650	22.285	B	2 1/16	2 1/4	2 1/4	4 1/8	1 2/32	2/32	1 1/4	0.343	43.10	40.10



### Single - Taper Bushed with Hardened Teeth

No. Teeth	Catalog Number
12	50BTB12H
13	50BTB13H
14	50BTB14H
15	50BTB15H
16	50BTB16H
17	50BTB17H
18	50BTB18H
19	50BTB19H
20	50BTB20H
21	50BTB21H
22	50BTB22H
23	50BTB23H
24	50BTB24H
25	50BTB25H
26	50BTB26H
27	50BTB27H
28	50BTB28H
30	50BTB30H

**SABER  
TOOTH®**

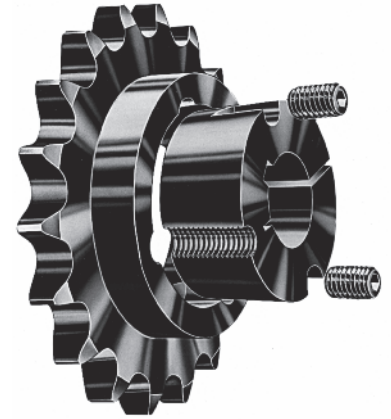
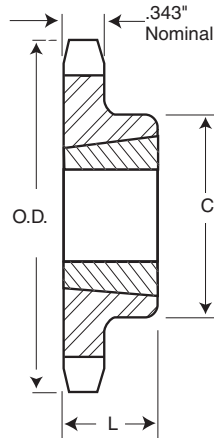

TYPE B

### Single - Taper Bushed

No. Teeth	Catalog Number	Bushing	Diameter		Max. Bore	Dimensions		Type	Weight Lbs. (Approx.)	
			Outside Diameter	Pitch Diameter		L	C		Rim Only	Bushing Only
12	50BTB12	1008	2.708	2.415	1	3/8	1 15/16**	B	0.5	0.3
13	50BTB13	1008	2.911	2.612	1	3/8	1 1/16	B	0.5	0.3
14	50BTB14	1008	3.113	2.809	1	3/8	1 15/16	B	0.6	0.3
15	50BTB15	1210	3.315	3.006	1 1/4	1	2 15/32**	B	0.7	0.6
16	50BTB16	1610	3.517	3.204	1 1/2	1	2 25/32**	B	0.7	0.9
17	50BTB17	1610	3.719	3.401	1 1/2	1	2 25/32**	B	0.8	0.9
18	50BTB18	1610	3.920	3.599	1 1/2	1	2 25/32	B	0.9	0.9
19	50BTB19	1610	4.120	3.797	1 1/2	1	3	B	1.3	0.9
20	50BTB20	1610	4.321	3.995	1 1/2	1	3 3/4	B	1.6	0.9
21	50BTB21	1610	4.522	4.193	1 1/2	1	3 1/2	B	1.5	0.9
22	50BTB22	1610	4.722	4.392	1 1/2	1	3 1/2	B	1.6	0.9
23	50BTB23	2012	4.922	4.590	2	1 1/4	3 3/8	B	2.0	1.7
24	50BTB24	2012	5.122	4.788	2	1 1/4	4	B	2.2	1.7
25	50BTB25	2012	5.322	4.987	2	1 1/4	4	B	2.4	1.7
26	50BTB26	2012	5.522	5.185	2	1 1/4	4	B	2.5	1.7
27	50BTB27	2012	5.723	5.384	2	1 1/4	4	B	2.6	1.7
28	50BTB28	2012	5.922	5.582	2	1 1/4	4	B	2.8	1.7
30	50BTB30	2012	6.321	5.979	2	1 1/4	3 3/8	B	3.2	1.7
32	50BTB32	2012	6.721	6.376	2	1 1/4	3 3/8	B	3.6	1.7
35	50BTB35	2012	7.319	6.972	2	1 1/4	3 3/8	B	4.2	1.7
36	50BTB36	2012	7.519	7.171	2	1 1/4	3 3/8	B	4.3	1.7
40	50BTB40	2012	8.316	7.966	2	1 1/4	3 3/8	B	5.2	1.7
42	50BTB42	2012	8.715	8.363	2	1 1/4	3 3/8	B	5.9	1.7
45	50BTB45	2012	9.313	8.960	2	1 1/4	3 3/8	B	6.5	1.7
48	50BTB48	2012	9.911	9.556	2	1 1/4	3 3/8	B	7.3	1.7
54	50BTB54	2012	11.106	10.749	2	1 1/4	3 3/8	B	9.0	1.7
60	50BTB60	2012	12.301	11.942	2	1 1/4	3 3/8	B	10.8	1.7
70	50BTB70	2517	14.292	13.931	2 1/2	1 1/4	4 1/4	B	14.0	3.5
72	50BTB72	2517	14.690	14.329	2 1/2	1 1/4	4 1/4	B	15.5	3.5
80	50BTB80	2517	16.282	15.920	2 1/2	1 1/4	4 1/4	B	19.5	3.5
84	50BTB84	2517	17.079	16.715	2 1/2	1 1/4	4 1/4	B	22.5	3.5
96	50BTB96	2517	19.466	19.102	2 1/2	1 1/4	4 1/4	B	29.0	3.5
112	50BTB112	2517	22.651	22.285	2 1/2	1 1/4	4 1/4	B	38.7	3.5

\*\* Has recessed groove in hub for chain clearance.

# No. 50

## 5/8" Pitch

# MST® Sprockets

# Martin

### Single - MST® Sprockets

No. Teeth	Catalog Number	Bush-ing	Diameters		Type	Max. Bore	Dimensions						Weight Lbs. (Approx.)	
			Outside Dia.	Pitch Dia.			OL	L	C	H	P	T(nom)	With Hub	Rim Only
13	50H13H	H	2.910	2.612	3	1-1/2	1 21/32	1 1/4	7/32	2-1/2	1-1/8	0.343	1.4	0.6
14	50H14H	H	3.110	2.809	3	1-1/2	1 19/32	1 1/4	5/32	2-1/2	1-1/16	0.343	1.4	0.6
15	50H15H	H	3.320	3.006	3	1-1/2	1 1/2	1 1/4	1/16	2-1/2	31/32	0.343	1.6	0.8
15	50P15H	P1	3.320	3.006	4	1-3/4	2 3/16	1 15/16	-	3	1-19/32	0.343	2.4	1.1
16	50H16H	H	3.520	3.204	3	1-1/2	1 1/2	1 1/4	1/16	2-1/2	31/32	0.343	1.7	0.9
16	50P16H	P1	3.520	3.204	4	1-3/4	2 3/16	1 15/16	-	3	1-19/32	0.343	2.7	1.4
17	50H17H	H	3.720	3.401	3	1-1/2	1 1/2	1 1/4	1/16	2-1/2	31/32	0.343	1.8	1.0
17	50P17H	P1	3.720	3.401	4	1-3/4	2 3/16	1 15/16	-	3	1-19/32	0.343	2.7	1.4
18	50H18H	H	3.920	3.599	3	1-1/2	1 1/2	1 1/4	1/16	2-1/2	31/32	0.343	1.9	1.1
18	50P18H	P1	3.920	3.599	4	1-3/4	2 3/16	1 15/16	-	3	1-19/32	0.343	3.1	1.8
19	50H19H	H	4.120	3.797	3	1-1/2	1 1/2	1 1/4	1/16	2-1/2	31/32	0.343	2.1	1.3
19	50P19H	P1	4.120	3.797	4	1-3/4	2 3/16	1 15/16	-	3	1-19/32	0.343	3.1	1.8
20	50H20H	H	4.320	3.995	3	1-1/2	1 1/2	1 1/4	1/16	2-1/2	31/32	0.343	2.3	1.5
20	50P20H	P1	4.320	3.995	4	1-3/4	2 3/16	1 15/16	-	3	1-19/32	0.343	3.3	2.0
21	50H21H	H	4.520	4.194	3	1-1/2	1 1/2	1 1/4	1/16	2-1/2	31/32	0.343	2.2	1.4
21	50P21H	P1	4.520	4.194	4	1-3/4	2 3/16	1 15/16	-	3	1-19/32	0.343	3.4	2.1
22	50H22H	H	4.720	4.392	3	1-1/2	1-1/2	1-1/4	1/16	2-1/2	31/32	0.343	2.3	1.5
22	50P22H	P1	4.720	4.392	4	1-3/4	2 3/16	1 15/16	-	3	1-19/32	0.343	3.5	2.2
23	50H23H	H	4.920	4.590	3	1-1/2	1-1/2	1-1/4	1/16	2-1/2	31/32	0.343	2.5	1.7
23	50P23H	P1	4.920	4.590	4	1-3/4	2 3/16	1 15/16	-	3	1-19/32	0.343	3.7	2.4
23	50Q23H	Q1	4.920	4.590	4	2-11/16	2-25/32	2-1/2	-	4-1/8	2-5/32	0.343	6.7	3.2
24	50H24H	H	5.120	4.788	3	1-1/2	1-1/2	1-1/4	1/16	2-1/2	31/32	0.343	2.6	1.8
24	50P24H	P1	5.120	4.788	4	1-3/4	2 3/16	1 15/16	-	3	1-19/32	0.343	3.9	2.6
24	50Q24H	Q1	5.120	4.788	4	2-11/16	2-25/32	2-1/2	-	4-1/8	2-5/32	0.343	7.0	3.5
25	50H25H	H	5.320	4.987	3	1-1/2	1-1/2	1-1/4	1/16	2-1/2	31/32	0.343	2.7	1.9
25	50P25H	P1	5.320	4.987	4	1-3/4	2 3/16	1 15/16	-	3	1-19/32	0.343	4.0	2.7
25	50Q25H	Q1	5.320	4.987	4	2-11/16	2-25/32	2-1/2	-	4-1/8	2-5/32	0.343	7.1	3.6
26	50H26H	H	5.520	5.185	3	1-1/2	1-1/2	1-1/4	1/16	2-1/2	31/32	0.343	2.8	2.0
26	50P26H	P1	5.520	5.185	4	1-3/4	2 3/16	1 15/16	-	3	1-19/32	0.343	4.1	2.8
26	50Q26H	Q1	5.520	5.185	4	2-11/16	2-25/32	2-1/2	-	4-1/8	2-5/32	0.343	7.2	3.7
27	50H27H	H	5.720	5.384	3	1-1/2	1-1/2	1-1/4	1/16	2-1/2	31/32	0.343	3.0	2.2
27	50P27H	P1	5.720	5.384	4	1-3/4	2 3/16	1 15/16	-	3	1-19/32	0.343	4.2	2.9
27	50Q27H	Q1	5.720	5.384	4	2-11/16	2-25/32	2-1/2	-	4-1/8	2-5/32	0.343	7.3	3.8
28	50H28H	H	5.920	5.582	3	1-1/2	1-1/2	1-1/4	1/16	2-1/2	31/32	0.343	3.3	2.5
28	50P28H	P1	5.920	5.582	4	1-3/4	2 3/16	1 15/16	-	3	1-19/32	0.343	4.3	3.0
28	50Q28H	Q1	5.920	5.582	4	2-11/16	2-25/32	2-1/2	-	4-1/8	2-5/32	0.343	7.5	4.0
29	50P29H	P1	6.120	5.781	4	1-3/4	2 3/16	1 15/16	-	3	1-19/32	0.343	4.7	3.4
30	50H30H	H	6.320	5.979	3	1-1/2	1-1/2	1-1/4	1/16	2-1/2	31/32	0.343	3.7	2.9
30	50P30H	P1	6.320	5.979	4	1-3/4	2 3/16	1 15/16	-	3	1-19/32	0.343	4.9	3.6
30	50Q30H	Q1	6.320	5.979	4	2-11/16	2-25/32	2-1/2	-	4-1/8	2-5/32	0.343	9.1	5.6
31	50P31	P1	6.520	6.178	4	1-3/4	2 3/16	1 15/16	-	3	1-19/32	0.343	4.9	3.6
32	50H32H	H	6.720	6.376	3	1-1/2	1-1/2	1 1/4	1/16	2-1/2	31/32	0.343	4.0	3.2
32	50P32	P1	6.720	6.376	4	1-3/4	2 3/16	1 15/16	-	3	1-19/32	0.343	5.2	3.9
32	50Q32	Q1	6.720	6.376	4	2-11/16	2-25/32	2-1/2	-	4-1/8	2-5/32	0.343	9.6	6.1
33	50H33H	H	6.920	6.575	3	1-1/2	1-1/2	1-1/4	1/16	2-1/2	31/32	0.343	4.2	3.4
33	50P33	P1	6.920	6.575	4	1-3/4	2 3/16	1 15/16	-	3	1-19/32	0.343	5.4	4.1
34	50H34H	H	7.120	6.774	3	1-1/2	1-1/2	1-1/4	1/16	2-1/2	31/32	0.343	4.5	3.7
34	50P34	P1	7.120	6.774	4	1-3/4	2 3/16	1 15/16	-	3	1-19/32	0.343	5.6	4.3
35	50H35H	H	7.320	6.972	3	1-1/2	1-1/2	1-1/4	1/16	2-1/2	31/32	0.343	4.6	3.8
35	50P35	P1	7.320	6.972	4	1-3/4	2 3/16	1 15/16	-	3	1-19/32	0.343	5.6	4.3
35	50Q35	Q1	7.320	6.972	4	2-11/16	2-25/32	2-1/2	-	4-1/8	2 5/32	0.343	10.3	6.8
36	50H36H	H	7.520	7.171	3	1-1/2	1-1/2	1-1/4	1/16	2-1/2	31/32	0.343	4.8	4.0
36	50P36	P1	7.520	7.171	4	1-3/4	2 3/16	1 15/16	-	3	1-19/32	0.343	6.1	4.8
36	50Q36	Q1	7.520	7.171	4	2-11/16	2-25/32	2-1/2	-	4-1/8	2-5/32	0.343	10.3	6.8
37	50Q37	Q1	7.720	7.370	4	2-11/16	2-25/32	2-1/2	-	4-1/8	2-5/32	0.343	10.5	7.0
38	50H38H	H	7.920	7.569	3	1-1/2	1-1/2	1-1/4	1/16	2-1/2	31/32	0.343	5.2	4.4
38	50Q38	Q1	7.920	7.569	4	2-11/16	2-25/32	2-1/2	-	4-1/8	2-5/32	0.343	10.9	7.4
39	50Q39	Q1	8.120	7.767	4	2-11/16	2-25/32	2-1/2	-	4-1/8	2-5/32	0.343	11.1	7.6
40	50H40H	H	8.320	7.966	3	1-1/2	1-1/2	1-1/4	1/16	2-1/2	31/32	0.343	5.6	4.8
40	50Q40	Q1	8.320	7.966	4	2-11/16	2-25/32	2-1/2	-	4-1/8	2-5/32	0.343	11.5	8.0
41	50Q41	Q1	8.520	8.165	4	2-11/16	2-25/32	2-1/2	-	4-1/8	2-5/32	0.343	11.7	8.2
42	50Q42	Q1	8.720	8.363	4	2-11/16	2-25/32	2-1/2	-	4-1/8	2-5/32	0.343	11.8	8.3
44	50Q44	Q1	9.110	8.761	4	2-11/16	2-25/32	2-1/2	-	4-1/8	2-5/32	0.343	12.1	8.6
45	50Q45	Q1	9.310	8.960	4	2-11/16	2-25/32	2-1/2	-	4-1/8	2-5/32	0.343	12.5	9.0
47	50Q47	Q1	9.710	9.357	4	2-11/16	2-25/32	2-1/2	-	4-1/8	2-5/32	0.343	12.8	9.3
48	50Q48	Q1	9.910	9.556	4	2-11/16	2-25/32	2-1/2	-	4-1/8	2-5/32	0.343	13.1	9.6
50	50Q50	Q1	10.310	9.954	4	2-11/16	2-25/32	2-1/2	-	4-1/8	2-5/32	0.343	13.3	9.8
54	50Q54	Q1	11.110	10.749	4	2-11/16	2-25/32	2-1/2	-	4-1/8	2-5/32	0.343	14.8	11.3
56	50Q56	Q1	11.500	11.147	4	2-11/16	2-25/32	2-1/2	-	4-1/8	2-5/32	0.343	15.8	12.3
60	50Q60	Q1	12.300	11.942	4	2-11/16	2-25/32	2-1/2	-	4-1/8	2-5/32	0.343	16.8	13.3
70	50Q70	Q1	14.290	13.931	4	2-11/16	2-25/32	2-1/2	-	4-1/8	2-5/32	0.343	20.4	16.9
72	50Q72	Q1	14.690	14.329	4	2-11/16	2-25/32	2-1/2	-	4-1/8	2-5/32	0.343	21.6	18.1
80	50Q80	Q1	16.280	15.920	4	2-11/16	2-25/32	2-1/2	-	4-1/8	2-5/32	0.343	24.6	21.1
84	50Q84	Q1	17.080	16.715	4	2-11/16	2-25/32	2-1/2	-	4-1/8	2-5/32	0.343	27.8	24.3
96	50Q96	Q1	19.470	19.102	4	2-11/16	2-25/32	2-1/2	-	4-1/8	2-5/32	0.343	33.3	29.8
112	50Q112	Q1	22.650	22.285	4	2-11/16	2-25/32	2-1/2	-	4-1/8	2-5/32	0.343	42.8	39.3

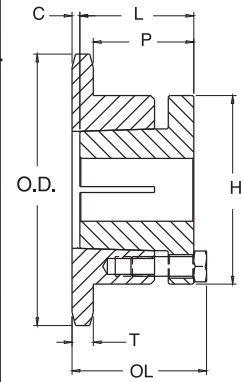

TYPE 3

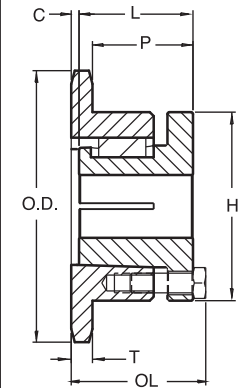

TYPE 4

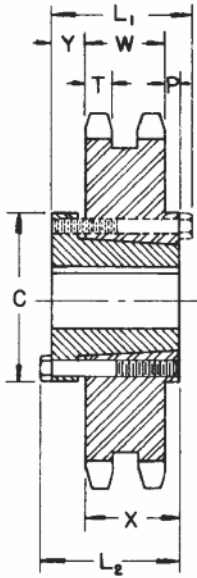

QD — TYPE C

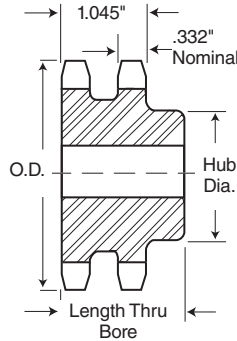

TYPE B

### Alteration Charges

See current discount sheet for alteration charges.

### Double - Type B

No. Teeth	Catalog Number	Outside Diameter	Type	Bore (inches)		Hub (inches)		Weight Lbs. (Approx.)
				Stock	Rec. Max.	Dia.	Length Thru	
11	D50B11H	2.500	B	5/8	15/16	1 1/32	1 1/4	0.96
12	D50B12H	2.710	B	5/8	1 1/8	1 1/16	1 1/4	1.25
13	D50B13H	2.910	B	5/8	1 1/8	1 1/8	1 1/4	1.56
14	D50B14H	3.110	B	5/8	1 1/8	1 1/8	1 1/4	1.86
15	D50B15H	3.320	B	3/4	1 1/2	2 1/16	1 1/4	2.22
16	D50B16H	3.520	B	3/4	1 1/2	2 1/2	1 1/4	2.62
17	D50B17H	3.720	B	3/4	1 1/2	2 1/16	1 1/4	3.04
18	D50B18H	3.920	B	3/4	1 1/2	2 1/16	1 1/4	3.58
19	D50B19H	4.120	B	1	2 1/8	3 3/8	1 1/4	3.90
20	D50B20H	4.320	B	1	2 1/4	3 1/4	1 1/4	4.26
21	D50B21H	4.520	B	1	2 3/8	3 1/2	1 1/4	4.90
22	D50B22H	4.720	B	1	2 3/8	3 3/8	1 1/4	5.58
23	D50B23H	4.920	B	1	2 1/2	3 3/8	1 1/4	6.10
24	D50B24H	5.120	B	1	2 1/2	3 3/8	1 1/4	6.50
25	D50B25H	5.320	B	1	2 1/2	3 3/8	1 1/4	6.94
26	D50B26	5.520	B	1	2 1/2	3 3/8	1 1/4	7.54
30	D50B30	6.320	B	1	2 1/2	3 3/4	1 1/4	9.40
32	D50B32	6.720	B	1	2 1/2	3 3/4	1 1/4	10.46
35	D50B35	7.320	B	1	2 1/2	3 3/4	1 1/4	12.28
36	D50B36	7.520	B	1 1/16	2 3/4	4	2 1/4	13.94
40	D50B40	8.320	B	1 1/16	2 3/4	4	2 1/4	16.54
42	D50B42	8.720	B	1 1/16	2 3/4	4	2 1/4	17.92
45	D50B45	9.310	B	1 1/16	2 3/4	4	2 1/4	20.30
48	D50B48	9.910	B	1 1/16	2 3/4	4 1/4	2 1/4	24.08
52	D50B52	10.710	B	1 1/16	2 3/4	4 1/4	2 1/4	27.42
54	D50B54	11.110	B	1 1/16	2 3/4	4 1/4	2 1/4	29.16
60	D50B60	12.300	B	1 1/16	3	4 1/2	2 1/4	35.88
68	D50B68	13.890	B	1 1/16	3	4 1/2	2 1/4	44.98
72	D50B72	14.690	B	1 1/16	3	4 1/2	2 1/4	50.22
76	D50B76	15.490	B	1 1/16	3	4 1/2	2 1/4	45.64
84	D50B84	17.080	B	1 1/16	3	4 1/2	2 1/4	51.64
95	D50B95	19.270	B	1 1/16	3	4 1/2	2 1/4	64.32
96	D50B96	19.470	B	1 1/16	3	4 1/2	2 1/4	67.42
102	D50B102	20.660	B	1 1/16	3	4 1/2	2 1/4	72.68
112	D50B112	22.650	B	1 1/16	3 3/16	5 1/4	2 1/4	90.22

Maximum bores shown will accommodate standard keyseat and setscrew over keyseat. Slightly larger bores are possible with no keyseat, shallow keyseat, or setscrew at angle to keyseat.

NOTE: Double 50 stock sprockets with 25 teeth or less have hardened teeth, as indicated by H suffix.

### Double - Type QD

No. Teeth	Catalog Number	Bush-ing	Diameters		Type	Max. Bore	Dimensions							Weight Lbs. (Approx.)		
			Outside Diameter	Pitch Diameter			L <sub>1</sub>	L <sub>2</sub>	C	Y	P	X	T	W	With Hub	Rim Only
36	D50SK36	SK	7.520	7.171	C	2 5/16	2 1/8	2 1/8	3 3/8	5/8	1 3/16	1 1/4	0.332	1.045	11.08	9.08
42	D50SK42	SK	8.720	8.363	C	2 5/16	2 1/8	2 1/8	3 3/8	5/8	1 3/16	1 1/4	0.332	1.045	15.16	13.16
48	D50SK48	SK	9.910	9.556	C	2 5/16	2 1/8	2 1/8	3 3/8	5/8	1 3/16	1 1/4	0.332	1.045	19.90	17.90
52	D50SF52	SF	10.710	10.351	C	2 5/16	2 1/4	2 1/4	4 3/8	3/4	1 3/16	1 1/4	0.332	1.045	24.26	21.26
54	D50SF54	SF	11.110	10.749	C	2 5/16	2 1/4	2 1/4	4 3/8	3/4	1 3/16	1 1/4	0.332	1.045	26.18	23.18
60	D50SF60	SF	12.300	11.942	C	2 5/16	2 1/4	2 1/4	4 3/8	3/4	1 3/16	1 1/4	0.332	1.045	32.12	29.12
68	D50SF68	SF	13.890	13.533	C	2 5/16	2 1/4	2 1/4	4 3/8	3/4	1 3/16	1 1/4	0.332	1.045	41.16	38.16
72	D50SF72	SF	14.690	14.329	C	2 5/16	2 1/4	2 1/4	4 3/8	3/4	1 3/16	1 1/4	0.332	1.045	46.28	43.26
76	D50SF76	SF	15.490	15.124	C	2 5/16	2 1/4	2 1/4	4 3/8	3/4	1 3/16	1 1/4	0.332	1.045	47.00	44.00
84	D50SF84	SF	17.080	16.715	C	2 5/16	2 1/4	2 1/4	4 3/8	3/4	1 3/16	1 1/4	0.332	1.045	48.89	45.88
95	D50SF95	SF	19.270	18.903	C	2 5/16	2 1/4	2 1/4	4 3/8	3/4	1 3/16	1 1/4	0.332	1.045	61.80	58.88
102	D50SF102	SF	20.660	20.295	C	2 5/16	2 1/4	2 1/4	4 3/8	3/4	1 3/16	1 1/4	0.332	1.045	69.02	66.02
112	D50SF112	SF	22.650	22.285	C	2 5/16	2 1/4	2 1/4	4 3/8	3/4	1 3/16	1 1/4	0.332	1.045	88.26	85.26

# No. 50-2

## 5/8" Pitch

# All Steel Stock Sprockets

# Martin

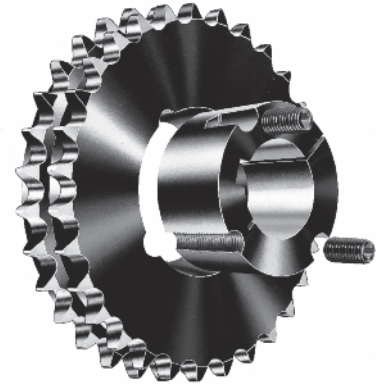
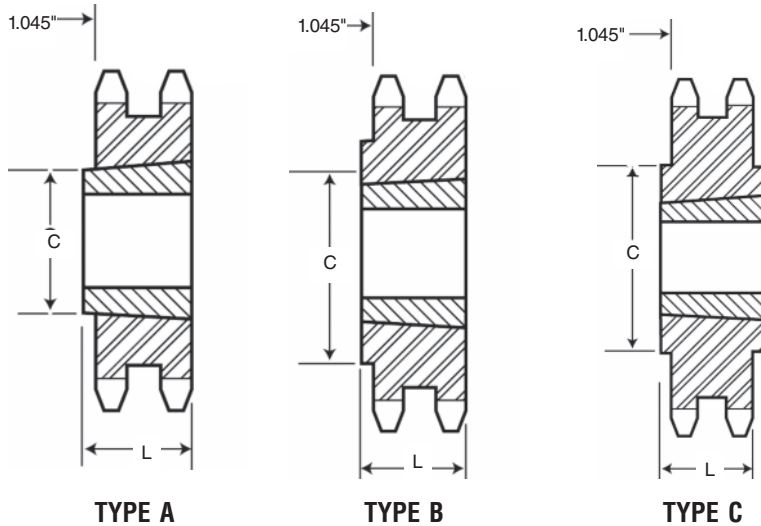

## Double - Taper Bushed

No. Teeth	Catalog Number	Bushing	Diameter		Max. Bore	Dimensions			Weight Lbs. (Approx.)	
			Outside Diameter	Pitch Diameter		L	C	Type	Rim Only	Bushing Only
14	D50ATB14H	1008	3.113	2.809	1	7/8	—	A	0.8	0.3
15	D50ATB15H	1210	3.315	3.006	1 1/4	1	—	A	0.9	0.6
16	D50ATB16H	1210	3.517	3.204	1 1/4	1	—	A	1.1	0.6
17	D50ATB17H	1610	3.719	3.410	1 1/2	1	—	A	1.1	0.6
18	D50ATB18H	1610	3.920	3.599	1 1/2	1	—	A	1.3	0.9
19	D50ATB19H	1610	4.120	3.797	1 1/2	1	—	A	1.6	0.9
20	D50BTB20H	2012	4.321	3.995	2	1 1/4	3 1/4	B	1.5	1.7
21	D50BTB21H	2012	4.522	4.193	2	1 1/4	3 1/2	B	1.9	1.7
25	D50BTB25H	2012	5.322	4.987	2	1 1/4	4 1/2	B	3.8	1.7
30	D50BTB30	2517	6.321	5.979	2 1/2	1 1/4	5 1/2	B	7.5	3.5
36	D50CTB36	2517	7.519	7.171	2 1/2	1 1/4	4 1/4	C	9.4	3.5
42	D50CTB42	2517	8.715	8.363	2 1/2	1 1/4	4 1/4	C	13.4	3.5
48	D50CTB48	2517	9.911	9.556	2 1/2	1 1/4	4 1/4	C	18.6	3.5
52	D50CTB52	2517	10.707	10.351	2 1/2	1 1/4	4 1/4	C	22.2	3.5
60	D50CTB60	2517	12.301	11.942	2 1/2	1 1/4	4 1/4	C	30.3	3.5
68	D50CTB68	2517	13.893	13.533	2 1/2	1 1/4	4 1/4	C	39.4	3.5
76	D50CTB76	2517	15.486	15.124	2 1/2	1 1/4	4 1/4	C	41.2	3.5
84	D50CTB84	2517	17.079	16.715	2 1/2	1 1/4	4 1/4	C	45.3	3.5
95	D50CTB95	2517	19.267	18.903	2 1/2	1 1/4	4 1/4	C	58.8	3.5
102	D50CTB102	2517	20.661	20.295	2 1/2	1 1/4	4 1/4	C	67.1	3.5

NOTE: Double 50 stock sprockets with 25 teeth or less have hardened teeth, as indicated by H suffix.

# Martin

## MST<sup>®</sup> Sprockets

## No. 50-2 5/8" Pitch

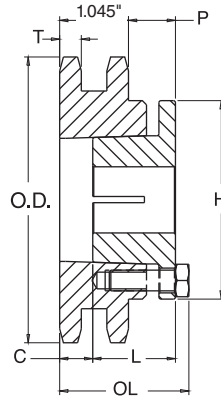
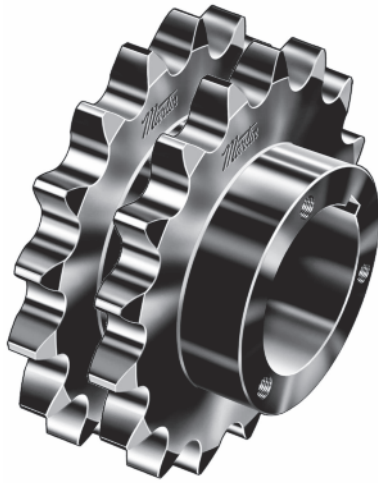

TYPE 11

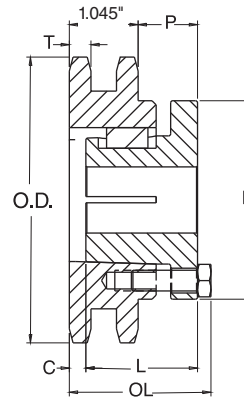

TYPE 12

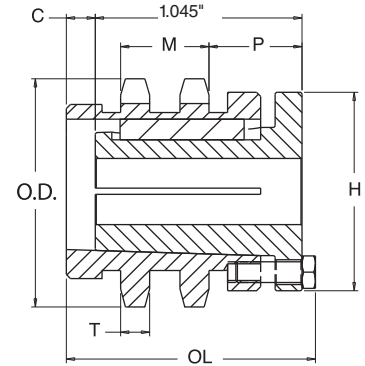

TYPE 16

### Double - MST<sup>®</sup> Sprockets

No. Teeth	Catalog Number	Bush-ing	Diameters		Type	Max. Bore	Dimensions						Weight Lbs. (Approx.)	
			Outside Dia.	Pitch Dia.			OL	L	C	H	P	T(nom)	With Hub	Rim Only
14	D50H14H	H	3.110	2.809	11	1-1/2	2-5/16	1-1/4	7/8	2-1/2	1-3/32	0.332	2.0	1.2
15	D50P15H	P1	3.320	3.006	16	1-3/4	3-7/16	1-15/16	1-1/4	3	1-13/32	0.332	3.3	2.0
16	D50P16H	P1	3.520	3.204	12	1-3/4	2-11/16	1-15/16	1/2	3	1-13/32	0.332	2.9	1.6
17	D50P17H	P1	3.720	3.401	12	1-3/4	2-11/16	1-15/16	1/2	3	1-13/32	0.332	3.4	2.1
18	D50P18H	P1	3.920	3.599	12	1-3/4	2-11/16	1-15/16	1/2	3	1-13/32	0.332	3.8	2.5
19	D50P19H	P1	4.120	3.797	12	1-3/4	2-3/16	1-15/16	-	3	29/32	0.332	3.3	2.0
20	D50P20H	P1	4.320	3.995	12	1-3/4	2-3/16	1-15/16	-	3	29/32	0.332	3.8	2.5
21	D50P21H	P1	4.520	4.194	12	1-3/4	2-3/16	1-15/16	-	3	29/32	0.332	4.1	2.8
22	D50P22H	P1	4.720	4.392	12	1-3/4	2-3/16	1-15/16	-	3	29/32	0.332	4.5	3.2
23	D50P23H	P1	4.920	4.590	12	1-3/4	2-3/16	1-15/16	-	3	29/32	0.332	4.9	3.6
24	D50Q24H	Q1	5.120	4.788	12	2-11/16	2-25/32	2-1/2	-	4-1/8	1-15/32	0.332	7.5	4.0
25	D50Q25H	Q1	5.320	4.987	12	2-11/16	2-25/32	2-1/2	-	4-1/8	1-15/32	0.332	8.0	4.5
26	D50Q26H	Q1	5.520	5.185	12	2-11/16	2-25/32	2-1/2	-	4-1/8	1-15/32	0.332	8.8	5.3
27	D50Q27H	Q1	5.720	5.384	12	2-11/16	2-25/32	2-1/2	-	4-1/8	1-15/32	0.332	9.4	5.9
28	D50Q28H	Q1	5.920	5.582	12	2-11/16	2-25/32	2-1/2	-	4-1/8	1-15/32	0.332	9.8	6.3
30	D50Q30H	Q1	6.320	5.979	12	2-11/16	2-25/32	2-1/2	-	4-1/8	1-15/32	0.332	11.0	7.5
32	D50Q32H	Q1	6.720	6.376	12	2-11/16	2-25/32	2-1/2	-	4-1/8	1-15/32	0.332	12.0	8.5
35	D50Q35H	Q1	7.320	6.972	12	2-11/16	2-25/32	2-1/2	-	4-1/8	1-15/32	0.332	13.9	10.4
36	D50Q36H	Q1	7.520	7.171	12	2-11/16	2-25/32	2-1/2	-	4-1/8	1-15/32	0.332	14.5	11.0
40	D50Q40H	Q1	8.320	7.966	12	2-11/16	2-25/32	2-1/2	-	4-1/8	1-15/32	0.332	17.1	13.6
42	D50Q42H	Q1	8.720	8.363	12	2-11/16	2-25/32	2-1/2	-	4-1/8	1-15/32	0.332	18.5	15.0
45	D50Q45H	Q1	9.310	8.960	12	2-11/16	2-25/32	2-1/2	-	4-1/8	1-15/32	0.332	21.0	17.5
48	D50Q48H	Q1	9.910	9.556	12	2-11/16	2-25/32	2-1/2	-	4-1/8	1-15/32	0.332	23.9	20.4
52	D50Q52	Q1	10.710	10.351	12	2-11/16	2-25/32	2-1/2	-	4-1/8	1-15/32	0.332	26.8	23.3
54	D50Q54	Q1	11.110	10.749	12	2-11/16	2-25/32	2-1/2	-	4-1/8	1-15/32	0.332	26.8	23.3
60	D50Q60	Q1	12.300	11.942	12	2-11/16	2-25/32	2-1/2	-	4-1/8	1-15/32	0.332	29.0	25.5
72	D50Q72	Q1	14.690	14.329	12	2-11/16	2-25/32	2-1/2	-	4-1/8	1-15/32	0.332	46.6	43.1
76	D50Q76	Q1	15.490	15.124	12	2-11/16	2-25/32	2-1/2	-	4-1/8	1-15/32	0.332	49.5	46.0
84	D50Q84	Q1	17.080	16.715	12	2-11/16	2-25/32	2-1/2	-	4-1/8	1-15/32	0.332	60.2	56.7
95	D50R95	R1	19.270	18.903	12	3-3/4	3-5/32	2-7/8	-	5-3/8	2-3/32	0.332	79.8	72.3
96	D50R96	R1	19.470	19.102	12	3-3/4	3-5/32	2-7/8	-	5-3/8	2-3/32	0.332	88.2	80.7
102	D50R102	R1	20.660	20.295	12	3-3/4	3-5/32	2-7/8	-	5-3/8	2-3/32	0.332	92.0	84.5
112	D50R112	R1	22.650	22.285	12	3-3/4	3-5/32	2-7/8	-	5-3/8	2-3/32	0.332	100.7	93.2

Sprockets with "H" suffix have hardened teeth.

# No. 50-3

## 5/8" Pitch

# All Steel Stock Sprockets

# Martin

## Triple - Type B & C

No. Teeth	Catalog Number	Outside Diameter	Type	Bore (inches)		Hub (inches)		Weight Lbs. (Approx.)
				Stock	Rec. Max.	Dia.	Length Thru	
11	E50B11H	2.500	B	5/8	15/16	1 1/32	2 1/2	1.42
12	E50B12H	2.710	B	5/8	1 1/8	1 1/16	2 1/2	1.84
13	E50B13H	2.910	B	5/8	1 1/4	1 1/8	2 1/2	2.28
14	E50B14H	3.110	B	5/8	1 1/2	2 1/16	2 1/2	2.72
15	E50B15H	3.320	B	3/4	1 1/2	2 5/16	2 1/2	3.24
16	E50B16H	3.520	B	3/4	1 3/4	2 1/2	2 1/2	3.76
17	E50B17H	3.720	B	3/4	1 3/4	2 11/16	2 1/2	4.38
18	E50B18H	3.920	B	3/4	1 5/8	2 5/8	2 1/2	5.10
19	E50B19H	4.120	B	1	2 1/8	3 1/8	2 1/2	5.60
20	E50B20H	4.320	B	1	2 1/4	3 1/4	2 1/2	6.42
21	E50B21H	4.520	B	1	2 3/8	3 3/8	2 1/2	7.42
22	E50B22H	4.720	B	1	2 3/4	3 3/4	2 1/2	8.13
23	E50B23H	4.920	B	1	2 1/2	3 3/8	2 1/2	8.85
24	E50B24H	5.120	B	1	2 1/2	3 3/8	2 1/2	9.42
25	E50B25H	5.320	B	1	2 1/2	3 3/8	2 1/2	10.16
26	E50B26	5.520	B	1	2 1/2	3 3/8	2 1/2	11.02
30	E50B30	6.320	B	1	2 1/2	3 3/8	2 1/2	14.24
35	E50B35	7.320	B	1	2 1/2	3 3/8	2 1/2	19.09
36	E50B36	7.520	B	1 1/16	2 3/4	4	2 1/2	20.60
42	E50B42	8.720	B	1 3/16	2 3/4	4	2 1/2	27.46
48	E50B48	9.910	B	1 3/16	2 3/4	4	3 3/8	36.64
52	E50B52	10.710	B	1 3/16	2 3/4	4	3 3/8	42.54
60	E50B60	12.300	B	1 1/8	3	4 1/2	3 3/8	57.17
68	E50B68	13.890	B	1 1/8	3	4 1/2	3 3/8	73.21
72	E50C72	14.690	C	1 1/8	3	4 3/4	3 3/8	57.04
76	E50C76	15.490	C	1 1/8	3	4 3/4	3 3/8	61.57
84	E50C84	17.080	C	1 1/8	3	4 3/4	3 1/2	62.86
95	E50C95	19.270	C	1 1/8	3	4 3/4	3 3/8	75.01
102	E50C102	20.660	C	1 1/8	3	4 3/4	3 3/8	86.26

Maximum bores shown will accommodate standard keyseat and setscrew over keyseat. Slightly larger bores are possible with no keyseat, shallow keyseat, or setscrew at angle to keyseat.

NOTE: Triple 50 stock sprockets with 25 teeth or less have Hardened Teeth. As indicated by H suffix.

**Alteration Charges**

See current discount sheet for alteration charges.

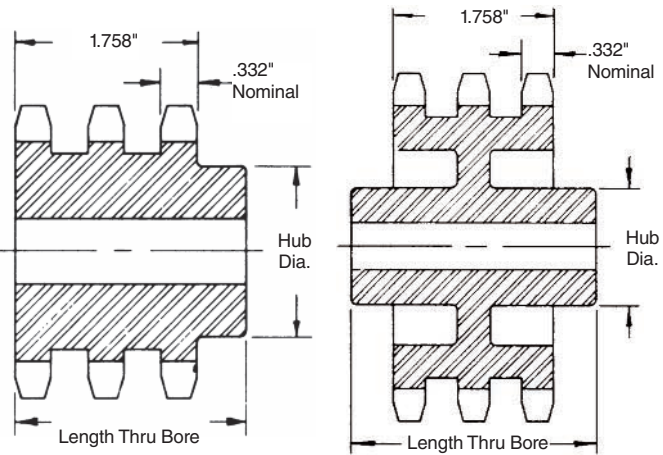

TYPE B

TYPE C

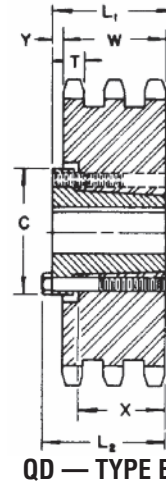

QD — TYPE B

NOTE: Triple 50 stock sprockets with 25 teeth or less have hardened teeth.

## Triple - Type QD

No. Teeth	Catalog Number	Bush-ing	Diameters		Type	Max. Bore	Dimensions								Weight Lbs. (Approx.)	
			Outside Diameter	Pitch Diameter			L <sub>1</sub>	L <sub>2</sub>	C	Y	V	X	T	W	With Hub	Rim Only
36	E50SK36	SK	7.520	7.171	B	2 1/2	2 1/2	2 1/2	3 3/8	1/2	—	1 1/4	0.332	1.758	14.8	12.8
42	E50SK42	SK	8.720	8.363	B	2 1/2	2 1/2	2 1/2	3 3/8	1/2	—	1 1/4	0.332	1.758	21.5	19.5
48	E50SK48	SK	9.910	9.556	B	2 1/2	2 1/2	2 1/2	3 3/8	1/2	—	1 1/4	0.332	1.758	29.6	27.6
52	E50SF52	SF	10.710	10.351	B	2 15/16	2 1/2	2 1/2	4 3/8	1/2	—	1 1/4	0.332	1.758	31.6	28.6
60	E50SF60	SF	12.300	11.942	B	2 15/16	2 1/2	2 1/2	4 3/8	1/2	—	1 1/4	0.332	1.758	42.1	41.3
68	E50SF68	SF	13.890	13.533	B	2 15/16	2 1/2	2 1/2	4 3/8	1/2	—	1 1/4	0.332	1.758	53.8	45.3
72	E50SF72	SF	14.690	14.329	B	2 15/16	2 1/2	2 1/2	4 3/8	1/2	1/2	1 1/4	0.332	1.758	46.6	60.2
76	E50SF76	SF	15.490	15.124	B	2 15/16	2 1/2	2 1/2	4 3/8	1/2	1/2	1 1/4	0.332	1.758	49.9	67.3
84	E50SF84	SF	17.080	16.715	B	2 15/16	2 1/2	2 1/2	4 3/8	1/2	1/2	1 1/4	0.332	1.758	53.9	72.4
95	E50SF95	SF	19.270	18.903	B	2 15/16	2 1/2	2 1/2	4 3/8	1/2	1/2	1 1/4	0.332	1.758	62.3	91.4
102	E50SF102	SF	20.660	20.295	B	2 15/16	2 1/2	2 1/2	4 3/8	1/2	1/2	1 1/4	0.332	1.758	69.3	103.2

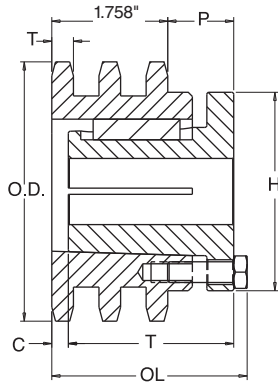

TYPE 22

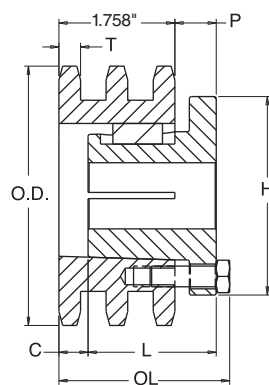

TYPE 23

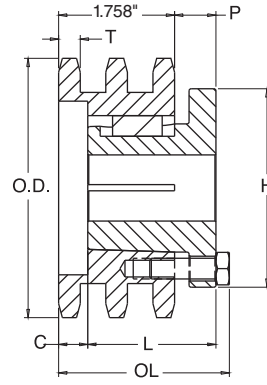

TYPE 24

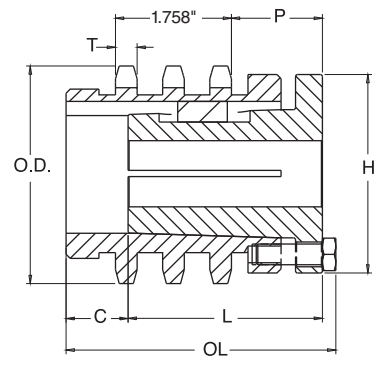

TYPE 27

### Triple - MST® Sprockets

No. Teeth	Catalog Number	Bush- ing	Diameters		Type	Max. Bore	Dimensions					Weight Lbs. (Approx.)		
			Outside Dia.	Pitch Dia.			OL	L	C	H	P	T(nom)	With Hub	Rim Only
15	E50P15H	P2	3.320	3.006	27	1-3/4	4-1/8	2-15/16	15/16	3	1-3/8	0.332	4.0	2.5
16	E50P16H	P2	3.520	3.204	22	1-3/4	3 3/8	2-15/16	3/16	3	1-3/8	0.332	3.9	2.4
17	E50P17H	P2	3.720	3.401	22	1-3/4	3 3/8	2-15/16	3/16	3	1-3/8	0.332	4.3	2.8
18	E50P18H	P2	3.920	3.599	22	1-3/4	3 3/8	2-15/16	3/16	3	1-3/8	0.332	4.9	3.4
19	E50P19H	P1	4.120	3.797	24	1-3/4	2-5/8	1-15/16	7/16	3	5/8	0.332	4.2	2.9
20	E50P20H	P1	4.320	3.995	24	1-3/4	2-5/8	1-15/16	7/16	3	5/8	0.332	4.4	3.1
21	E50P21H	P1	4.520	4.194	24	1-3/4	2-5/8	1-15/16	7/16	3	5/8	0.332	4.8	3.5
23	E50P23H	P1	4.920	4.590	24	1-3/4	2-5/8	1-15/16	7/16	3	5/8	0.332	5.8	4.5
24	E50Q24H	Q1	5.120	4.788	23	2-11/16	2-25/32	2-1/2	-	4-1/8	3/4	0.332	8.2	4.7
25	E50Q25H	Q1	5.320	4.987	23	2-11/16	2-25/32	2-1/2	-	4-1/8	3/4	0.332	8.5	5.0
26	E50Q26H	Q1	5.520	5.185	23	2-11/16	2-25/32	2-1/2	-	4-1/8	3/4	0.332	9.4	5.9
28	E50Q28H	Q1	5.920	5.582	23	2-11/16	2-25/32	2-1/2	-	4-1/8	3/4	0.332	10.8	7.3
30	E50Q30H	Q1	6.320	5.979	23	2-11/16	2-25/32	2-1/2	-	4-1/8	3/4	0.332	12.3	8.8
32	E50Q32H	Q1	6.720	6.376	23	2-11/16	2-25/32	2-1/2	-	4-1/8	3/4	0.332	14.4	10.9
35	E50Q35H	Q1	7.320	6.972	23	2-11/16	2-25/32	2-1/2	-	4-1/8	3/4	0.332	17.2	13.7
36	E50Q36H	Q1	7.520	7.171	23	2-11/16	2-25/32	2-1/2	-	4-1/8	3/4	0.332	18.1	14.6
40	E50Q40H	Q1	8.320	7.966	23	2-11/16	2-25/32	2-1/2	-	4-1/8	3/4	0.332	22.6	19.1
42	E50Q42H	Q1	8.720	8.363	23	2-11/16	2-25/32	2-1/2	-	4-1/8	3/4	0.332	25.0	21.5
48	E50Q48H	Q1	9.910	9.556	23	2-11/16	2-25/32	2-1/2	-	4-1/8	3/4	0.332	33.1	29.6
52	E50Q52	Q1	10.710	10.351	23	2-11/16	2-25/32	2-1/2	-	4-1/8	3/4	0.332	39.9	36.4
60	E50R60	R1	12.300	11.942	22	3-3/4	2-5/32	2-7/8	-	5-3/8	1-1/8	0.332	55.5	48.0
68	E50R68	R1	13.890	13.533	22	3-3/4	2-5/32	2-7/8	-	5-3/8	1-1/8	0.332	71.0	63.5
72	E50R72	R1	14.690	14.329	22	3-3/4	2-5/32	2-7/8	-	5-3/8	1-1/8	0.332	79.5	72.0
76	E50R76	R1	15.490	15.124	22	3-3/4	2-5/32	2-7/8	-	5-3/8	1-1/8	0.332	88.5	81.0
84	E50R84	R1	17.080	16.715	22	3-3/4	2-5/32	2-7/8	-	5-3/8	1-1/8	0.332	107.5	100.0
95	E50R95	R1	19.270	18.903	22	3-3/4	2-5/32	2-7/8	-	5-3/8	1-1/8	0.332	137.5	130.0
102	E50R102	R1	20.660	20.295	22	3-3/4	2-5/32	2-7/8	-	5-3/8	1-1/8	0.332	158.5	151.0

Sprockets with "H" suffix have hardened teeth.

# No. 60

## 3/4" Pitch

# All Steel Stock Sprockets

# Martin

### Single Type BS — 2 Setscrews — Bored-To-Size

No. Teeth	Catalog Number	Outside Diameter	Length Thru Bore	Weight Lbs. (Approx.)	Stock Finished Bores Includes Keyway and Setscrews
9	60BS9	2.510	1 1/4	0.6	3/4 — 7/8 — 1
10	60BS10	2.760	1 1/4	0.7	3/4 — 7/8 — 1 — 1 1/8 — 1 1/4 — 1 1/2
11	60BS11	3.000	1 1/4	0.9	3/4 — 7/8 — 1 — 1 1/8 — 1 1/4 — 1 1/2
11	60BS11W*	3.000	1 1/4	0.8	1 1/4
12	60BS12	3.250	1 1/4	1.3	3/4 — 7/8 — 1 — 1 1/8 — 1 1/4 — 1 1/2 — 1 3/4
12	60BS12W*	3.250	1 1/4	1.1	1 1/4
13	60BS13	3.490	1 1/4	1.3	3/4 — 7/8 — 1 — 1 1/8 — 1 1/4 — 1 1/2 — 1 3/4 — 1 7/8 — 1 7/8 — 1 1/2
14	60BS14	3.740	1 1/4	1.6	3/4 — 7/8 — 1 — 1 1/8 — 1 1/4 — 1 1/2 — 1 3/4 — 1 7/8 — 1 7/8 — 1 1/2 — 1 5/8
15	60BS15	3.980	1 1/4	1.7	3/4 — 7/8 — 1 — 1 1/8 — 1 1/4 — 1 1/2 — 1 3/4 — 1 7/8 — 1 7/8 — 1 1/2 — 1 5/8 — 1 3/4
16	60BS16	4.220	1 1/4	2.1	3/4 — 7/8 — 1 — 1 1/8 — 1 1/4 — 1 1/2 — 1 3/4 — 1 7/8 — 1 7/8 — 1 1/2 — 1 5/8 — 1 3/4 — 1 5/8
17	60BS17	4.460	1 1/4	2.4	1 — 1 1/8 — 1 1/4 — 1 1/2 — 1 3/4 — 1 7/8 — 1 7/8 — 1 1/2 — 1 5/8 — 1 3/4 — 1 5/8
18	60BS18	4.700	1 1/4	2.6	1 — 1 1/8 — 1 1/4 — 1 1/2 — 1 3/4 — 1 7/8 — 1 7/8 — 1 1/2 — 1 5/8 — 1 3/4 — 1 5/8
18	60BS18W*	4.700	1 1/4	2.6	1 1/4
19	60BS19	4.950	1 1/4	3.4	1 — 1 1/8 — 1 1/4 — 1 1/2 — 1 3/4 — 1 7/8 — 1 7/8 — 1 1/2 — 1 5/8 — 1 3/4 — 1 5/8
20	60BS20	5.190	1 1/4	3.9	1 — 1 1/8 — 1 1/4 — 1 1/2 — 1 3/4 — 1 7/8 — 1 7/8 — 1 1/2 — 1 5/8 — 1 3/4 — 1 5/8
21	60BS21	5.430	1 1/4	4.4	1 — 1 1/8 — 1 1/4 — 1 1/2 — 1 3/4 — 1 7/8 — 1 7/8 — 1 1/2 — 1 5/8 — 1 3/4 — 1 5/8
22	60BS22	5.670	1 1/4	4.7	1 — 1 1/8 — 1 1/4 — 1 1/2 — 1 3/4 — 1 7/8 — 1 7/8 — 1 1/2 — 1 5/8 — 1 3/4 — 1 5/8
23	60BS23	5.910	1 1/4	5.0	1 — 1 1/8 — 1 1/4 — 1 1/2 — 1 3/4 — 1 7/8 — 1 7/8 — 1 1/2 — 1 5/8 — 1 3/4 — 1 5/8
24	60BS24	6.150	1 1/4	5.3	1 — 1 1/8 — 1 1/4 — 1 1/2 — 1 3/4 — 1 7/8 — 1 7/8 — 1 1/2 — 1 5/8 — 1 3/4 — 1 5/8
25	60BS25	6.390	1 1/4	5.4	1 — 1 1/8 — 1 1/4 — 1 1/2 — 1 3/4 — 1 7/8 — 1 7/8 — 1 1/2 — 1 5/8 — 1 3/4 — 1 5/8
26	60BS26	6.630	1 1/4	5.8	1 — 1 1/8 — 1 1/4 — 1 1/2 — 1 3/4 — 1 7/8 — 1 7/8 — 1 1/2 — 1 5/8 — 1 3/4 — 1 5/8
27	60BS27	6.870	1 1/4	6.3	1 — 1 1/8 — 1 1/4 — 1 1/2 — 1 3/4 — 1 7/8 — 1 7/8 — 1 1/2 — 1 5/8 — 1 3/4 — 1 5/8
28	60BS28	7.110	1 1/4	6.4	1 — 1 1/8 — 1 1/4 — 1 1/2 — 1 3/4 — 1 7/8 — 1 7/8 — 1 1/2 — 1 5/8 — 1 3/4 — 1 5/8
29	60BS29	7.350	1 1/4	6.9	1 — 1 1/8 — 1 1/4 — 1 1/2 — 1 3/4 — 1 7/8 — 1 7/8 — 1 1/2 — 1 5/8 — 1 3/4 — 1 5/8
30	60BS30	7.590	1 1/4	7.1	1 — 1 1/8 — 1 1/4 — 1 1/2 — 1 3/4 — 1 7/8 — 1 7/8 — 1 1/2 — 1 5/8 — 1 3/4 — 1 5/8
31	60BS31	7.830	1 1/4	7.4	1 — 1 1/8 — 1 1/4 — 1 1/2 — 1 3/4 — 1 7/8 — 1 7/8 — 1 1/2 — 1 5/8 — 1 3/4 — 1 5/8
32	60BS32	8.070	1 1/4	7.8	1 — 1 1/8 — 1 1/4 — 1 1/2 — 1 3/4 — 1 7/8 — 1 7/8 — 1 1/2 — 1 5/8 — 1 3/4 — 1 5/8
33	60BS33	8.300	1 1/4	8.2	1 — 1 1/8 — 1 1/4 — 1 1/2 — 1 3/4 — 1 7/8 — 1 7/8 — 1 1/2 — 1 5/8 — 1 3/4 — 1 5/8
34	60BS34	8.540	1 1/4	8.5	1 — 1 1/8 — 1 1/4 — 1 1/2 — 1 3/4 — 1 7/8 — 1 7/8 — 1 1/2 — 1 5/8 — 1 3/4 — 1 5/8
35	60BS35	8.780	1 1/4	8.8	1 — 1 1/8 — 1 1/4 — 1 1/2 — 1 3/4 — 1 7/8 — 1 7/8 — 1 1/2 — 1 5/8 — 1 3/4 — 1 5/8
36	60BS36	9.020	1 1/4	9.2	1 — 1 1/8 — 1 1/4 — 1 1/2 — 1 3/4 — 1 7/8 — 1 7/8 — 1 1/2 — 1 5/8 — 1 3/4 — 1 5/8 — 2 — 2 1/8 — 2 1/8
37	60BS37	9.260	1 1/4	9.9	1 — 1 1/8 — 1 1/4 — 1 1/2 — 1 3/4 — 1 7/8 — 1 7/8 — 1 1/2 — 1 5/8 — 1 3/4 — 1 5/8 — 2 — 2 1/8 — 2 1/8
38	60BS38	9.500	1 1/4	10.5	1 — 1 1/8 — 1 1/4 — 1 1/2 — 1 3/4 — 1 7/8 — 1 7/8 — 1 1/2 — 1 5/8 — 1 3/4 — 1 5/8 — 2 — 2 1/8 — 2 1/8
39	60BS39	9.740	1 1/4	10.9	1 — 1 1/8 — 1 1/4 — 1 1/2 — 1 3/4 — 1 7/8 — 1 7/8 — 1 1/2 — 1 5/8 — 1 3/4 — 1 5/8 — 2 — 2 1/8 — 2 1/8
40	60BS40	9.980	1 1/4	11.2	1 — 1 1/8 — 1 1/4 — 1 1/2 — 1 3/4 — 1 7/8 — 1 7/8 — 1 1/2 — 1 5/8 — 1 3/4 — 1 5/8 — 2 — 2 1/8 — 2 1/8
41	60BS41	10.220	1 1/4	11.8	1 — 1 1/8 — 1 1/4 — 1 1/2 — 1 3/4 — 1 7/8 — 1 7/8 — 1 1/2 — 1 5/8 — 1 3/4 — 1 5/8 — 2 — 2 1/8 — 2 1/8
42	60BS42	10.460	1 1/4	12.4	1 — 1 1/8 — 1 1/4 — 1 1/2 — 1 3/4 — 1 7/8 — 1 7/8 — 1 1/2 — 1 5/8 — 1 3/4 — 1 5/8 — 2 — 2 1/8 — 2 1/8
43	60BS43	10.700	1 1/4	13.0	1 — 1 1/8 — 1 1/4 — 1 1/2 — 1 3/4 — 1 7/8 — 1 7/8 — 1 1/2 — 1 5/8 — 1 3/4 — 1 5/8 — 2 — 2 1/8 — 2 1/8
44	60BS44	10.940	1 1/4	13.5	1 — 1 1/8 — 1 1/4 — 1 1/2 — 1 3/4 — 1 7/8 — 1 7/8 — 1 1/2 — 1 5/8 — 1 3/4 — 1 5/8 — 2 — 2 1/8 — 2 1/8
45	60BS45	11.180	1 1/4	13.8	1 — 1 1/8 — 1 1/4 — 1 1/2 — 1 3/4 — 1 7/8 — 1 7/8 — 1 1/2 — 1 5/8 — 1 3/4 — 1 5/8 — 2 — 2 1/8 — 2 1/8
46	60BS46	11.420	1 1/4	14.1	1 — 1 1/8 — 1 1/4 — 1 1/2 — 1 3/4 — 1 7/8 — 1 7/8 — 1 1/2 — 1 5/8 — 1 3/4 — 1 5/8 — 2 — 2 1/8 — 2 1/8
47	60BS47	11.650	1 1/4	14.6	1 — 1 1/8 — 1 1/4 — 1 1/2 — 1 3/4 — 1 7/8 — 1 7/8 — 1 1/2 — 1 5/8 — 1 3/4 — 1 5/8 — 2 — 2 1/8 — 2 1/8
48	60BS48	11.890	1 1/4	15.4	1 — 1 1/8 — 1 1/4 — 1 1/2 — 1 3/4 — 1 7/8 — 1 7/8 — 1 1/2 — 1 5/8 — 1 3/4 — 1 5/8 — 2 — 2 1/8 — 2 1/8
49	60BS49	12.130	1 1/4	16.4	1 — 1 1/8 — 1 1/4 — 1 1/2 — 1 3/4 — 1 7/8 — 1 7/8 — 1 1/2 — 1 5/8 — 1 3/4 — 1 5/8 — 2 — 2 1/8 — 2 1/8
50	60BS50	12.370	1 1/4	17.3	1 — 1 1/8 — 1 1/4 — 1 1/2 — 1 3/4 — 1 7/8 — 1 7/8 — 1 1/2 — 1 5/8 — 1 3/4 — 1 5/8 — 2 — 2 1/8 — 2 1/8
51	60BS51	12.610	1 1/4	18.3	1 — 1 1/8 — 1 1/4 — 1 1/2 — 1 3/4 — 1 7/8 — 1 7/8 — 1 1/2 — 1 5/8 — 1 3/4 — 1 5/8 — 2 — 2 1/8 — 2 1/8
52	60BS52	12.850	1 1/4	19.3	1 — 1 1/8 — 1 1/4 — 1 1/2 — 1 3/4 — 1 7/8 — 1 7/8 — 1 1/2 — 1 5/8 — 1 3/4 — 1 5/8 — 2 — 2 1/8 — 2 1/8
53	60BS53	13.090	1 1/4	20.3	1 — 1 1/8 — 1 1/4 — 1 1/2 — 1 3/4 — 1 7/8 — 1 7/8 — 1 1/2 — 1 5/8 — 1 3/4 — 1 5/8 — 2 — 2 1/8 — 2 1/8
54	60BS54	13.330	1 1/4	21.0	1 — 1 1/8 — 1 1/4 — 1 1/2 — 1 3/4 — 1 7/8 — 1 7/8 — 1 1/2 — 1 5/8 — 1 3/4 — 1 5/8 — 2 — 2 1/8 — 2 1/8
55	60BS55	13.570	1 1/4	21.2	1 — 1 1/8 — 1 1/4 — 1 1/2 — 1 3/4 — 1 7/8 — 1 7/8 — 1 1/2 — 1 5/8 — 1 3/4 — 1 5/8 — 2 — 2 1/8 — 2 1/8
56	60BS56	13.810	1 1/4	21.3	— 1 1/8 — 1 1/4 — 1 1/2 — 1 3/4 — 1 7/8 — 1 7/8 — 1 1/2 — 1 5/8 — 1 3/4 — 1 5/8 — 2 — 2 1/8 — 2 1/8
57	60BS57	14.040	1 1/4	22.2	— 1 1/8 — 1 1/4 — 1 1/2 — 1 3/4 — 1 7/8 — 1 7/8 — 1 1/2 — 1 5/8 — 1 3/4 — 1 5/8 — 2 — 2 1/8 — 2 1/8
58	60BS58	14.280	1 1/4	23.0	— 1 1/8 — 1 1/4 — 1 1/2 — 1 3/4 — 1 7/8 — 1 7/8 — 1 1/2 — 1 5/8 — 1 3/4 — 1 5/8 — 2 — 2 1/8 — 2 1/8
59	60BS59	14.520	1 1/4	23.8	— 1 1/8 — 1 1/4 — 1 1/2 — 1 3/4 — 1 7/8 — 1 7/8 — 1 1/2 — 1 5/8 — 1 3/4 — 1 5/8 — 2 — 2 1/8 — 2 1/8
60	60BS60	14.760	1 1/4	25.0	— 1 1/8 — 1 1/4 — 1 1/2 — 1 3/4 — 1 7/8 — 1 7/8 — 1 1/2 — 1 5/8 — 1 3/4 — 1 5/8 — 2 — 2 1/8 — 2 1/8
70	60BS70	17.150	1 3/4	31.4	— 1 1/8 — 1 1/4 — 1 1/2 — 1 3/4 — 1 7/8 — 1 7/8 — 1 1/2 — 1 5/8 — 1 3/4 — 1 5/8 — 2 — 2 1/8 — 2 1/8
72	60BS72	17.630	2	33.5	— 1 1/8 — 1 1/4 — 1 1/2 — 1 3/4 — 1 7/8 — 1 7/8 — 1 1/2 — 1 5/8 — 1 3/4 — 1 5/8 — 2 — 2 1/8 — 2 1/8
80	60BS80	19.540	2	41.2	— 1 1/8 — 1 1/4 — 1 1/2 — 1 3/4 — 1 7/8 — 1 7/8 — 1 1/2 — 1 5/8 — 1 3/4 — 1 5/8 — 2 — 2 1/8 — 2 1/8
84	60BS84	20.490	2	45.8	— 1 1/8 — 1 1/4 — 1 1/2 — 1 3/4 — 1 7/8 — 1 7/8 — 1 1/2 — 1 5/8 — 1 3/4 — 1 5/8 — 2 — 2 1/8 — 2 1/8
96	60BS96	23.360	2 1/2	62.3	— 1 1/8 — 1 1/4 — 1 1/2 — 1 3/4 — 1 7/8 — 1 7/8 — 1 1/2 — 1 5/8 — 1 3/4 — 1 5/8 — 2 — 2 1/8 — 2 1/8
112	60BS112	27.180	2 1/2	81.0	— 1 1/8 — 1 1/4 — 1 1/2 — 1 3/4 — 1 7/8 — 1 7/8 — 1 1/2 — 1 5/8 — 1 3/4 — 1 5/8 — 2 — 2 1/8 — 2 1/8

Hub diameters vary to suit different bore sizes.

W = Winch Sprockets — KW 3/16" x 3/32" — One SS at 90°

KEYWAY IS ON CENTER LINE OF TOOTH.





### SABER TOOTH®

#### No. 60-Hardened Teeth — 2 Setscrews

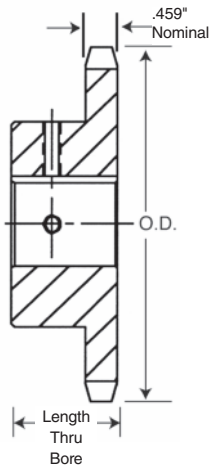

**TYPE BS**

No. Teeth	Catalog Number	Outside Diameter	Length Thru Bore	Weight Lbs. (Approx.)	Stock Finished Bores Includes Keyway and Setscrews
9	60BS9HT	2.51	1 1/4	0.6	3/4 — 7/8 — 1
10	60BS10HT	2.76	1 1/4	0.7	1 — 1 1/8 — 1 1/16 — 1 1/4
11	60BS11HT	3.00	1 1/4	0.9	1 — 1 1/8 — 1 1/16 — 1 1/4
12	60BS12HT	3.25	1 1/4	1.3	1 — 1 1/8 — 1 1/16 — 1 1/4 — 1 1/16
13	60BS13HT	3.49	1 1/4	1.3	1 — 1 1/8 — 1 1/16 — 1 1/4 — 1 1/16 — 1 1/2
14	60BS14HT	3.74	1 1/4	1.6	1 — 1 1/8 — 1 1/16 — 1 1/4 — 1 1/16 — 1 1/2 — 1 1/8
15	60BS15HT	3.98	1 1/4	1.7	1 — 1 1/8 — 1 1/16 — 1 1/4 — 1 1/16 — 1 1/2 — 1 1/8 — 1 1/4
16	60BS16HT	4.22	1 1/4	2.1	1 — 1 1/8 — 1 1/16 — 1 1/4 — 1 1/16 — 1 1/2 — 1 1/8 — 1 1/4 — 1 1/16
17	60BS17HT	4.46	1 1/4	2.4	1 — 1 1/8 — 1 1/16 — 1 1/4 — 1 1/16 — 1 1/2 — 1 1/8 — 1 1/4 — 1 1/16
18	60BS18HT	4.70	1 1/4	2.6	1 — 1 1/8 — 1 1/16 — 1 1/4 — 1 1/16 — 1 1/2 — 1 1/8 — 1 1/4 — 1 1/16
19	60BS19HT	4.95	1 1/4	3.4	1 — 1 1/8 — 1 1/16 — 1 1/4 — 1 1/16 — 1 1/2 — 1 1/8 — 1 1/4 — 1 1/16

KEYWAY IS ON CENTER LINE OF TOOTH.

*Martin* stock hardened teeth sprockets afford longer chain and sprocket life. Hardened teeth on the smaller sprocket of a roller chain drive are recommended if the drive ratio is four to one or greater or if the smaller sprocket has 24 teeth or less and is running at a speed of over 600 R.P.M.

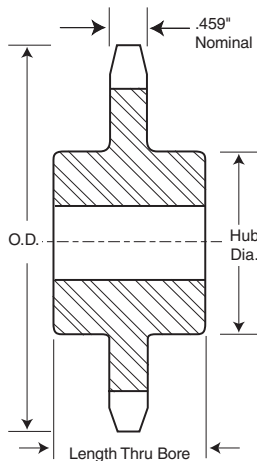

**TYPE C**

#### Single - Type C

No. Teeth	Catalog Number	Outside Diameter	Bore (inches)		Hub (inches)		Weight Lbs. (Approx.)
			Stock	Rec. Max.	Diameter	Length	
12	60C12	3.250	3/4	1 1/8	2 5/8★★	2	2.25
13	60C13	3.490	3/4	1 1/2	2 1/2	2	2.75
14	60C14	3.740	3/4	1 3/4	2 1/16	2	3.19
15	60C15	3.980	3/4	1 7/8	2 1/8	2	3.10
16	60C16	4.220	3/4	2	3 1/16	2	4.19
17	60C17	4.460	3/4	2 1/4	3 1/4	2	4.81
18	60C18	4.700	3/4	2 3/4	3 1/2	2	5.62

★★ Has recessed groove in hub for chain clearance.

No. 60  
3/4" Pitch

All Steel  
Stock Sprockets

Martin

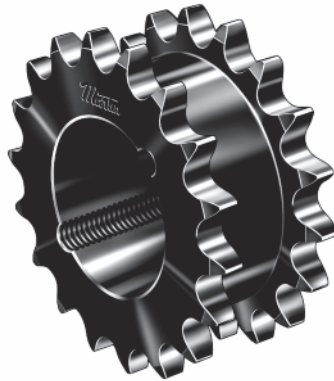

### Double Single - Type A — Steel

No. Teeth	Catalog Number	Diameters		Type	Min. Bore	Max. Bore	Dimensions				Wt. Lbs. (Approx.)
		Outside Diameter	Pitch Diameter				L	C	E	w Nom.	
13	DS60A13	3.490	3.134	A	3/4	1 1/4	1 15/16	1 3/64	2 1/32	0.459	2.6
14	DS60A14	3.740	3.371	A	3/4	1 1/8	1 15/16	1 3/64	2 7/16	0.459	3.2
15	DS60A15	3.980	3.607	A	3/4	1 1/2	1 15/16	1 3/64	2 7/8	0.459	3.8
16	DS60A16	4.220	3.844	A	3/4	1 1/8	1 15/16	1 3/64	3 3/64	0.459	4.5
17	DS60A17	4.460	4.082	A	3/4	1 3/4	1 15/16	1 3/64	3 1/4	0.459	5.3
18	DS60A18	4.700	4.319	A	3/4	1 7/8	1 15/16	1 3/64	3 1/2	0.459	6.5
19	DS60A19	4.950	4.557	A	3/4	2 1/8	1 15/16	1 3/64	3 5/8	0.459	6.8
20	DS60A20	5.190	4.794	A	3/4	2 1/4	1 15/16	1 3/64	3 5/8	0.459	7.0
21	DS60A21	5.430	5.032	A	3/4	2 3/4	1 15/16	1 3/64	4 1/16	0.459	7.5
22	DS60A22	5.670	5.270	A	3/4	2 3/4	1 15/16	1 3/64	4 7/16	0.459	11.0
23	DS60A23	5.910	5.508	A	3/4	2 3/4	1 15/16	1 3/64	4 21/32	0.459	11.5
24	DS60A24	6.150	5.749	A	3/4	2 3/4	1 15/16	1 3/64	4 29/32	0.459	12.0

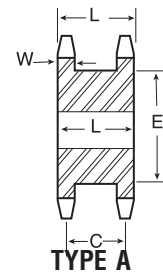

### Double Single - Taper Bushed — Steel

No. Teeth	Catalog Number	Bushing Size	Diameters		Min. Bore	Max. Bore	Type	Dimensions				w Nom.	Wt. Rim Only
			Outside Diameter	Pitch Diameter				L <sub>1</sub>	C	E	L <sub>2</sub>		
16	DS60ATB16H	1615	4.220	3.844	1/2	1 1/8	A	1 15/16	1 3/64	2 23/64	1 1/2	0.459	4.5
17	DS60ATB17H	1615	4.460	4.002	1/2	1 1/8	A	1 15/16	1 31/64	3 3/32	1 1/2	0.459	4.5
18	DS60ATB18H	2012	4.700	4.319	1/2	2	A	1 15/16	1 3/64	3 3/32	1 1/4	0.459	5.0
19	DS60ATB19H	2012	4.950	4.557	1/2	2	A	1 15/16	1 3/64	3 3/64	1 1/4	0.459	5.8
20	DS60ATB20H	2517	5.190	4.794	1/2	2 1/2	A	1 15/16	1 31/64	3 3/64	1 3/4	0.459	5.6
21	DS60ATB21H	2517	5.430	5.032	1/2	2 1/2	A	1 15/16	1 3/64	4 1/16	1 3/4	0.459	6.4
23	DS60ATB23H	2517	5.910	5.508	1/2	2 1/2	A	1 15/16	1 3/64	4 3/64	1 3/4	0.459	7.3
24	DS60ATB24H	2517	6.150	5.746	1/2	2 1/2	A	1 15/16	1 31/64	4 29/32	1 3/4	0.459	8.2

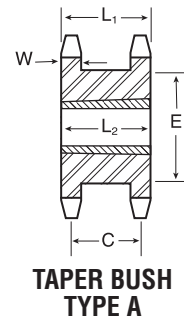

### Double Single - MST® — Steel

No. Teeth	Catalog Number	Bushing Size	Diameters		Min. Bore	Max. Bore	Type	Dimensions				w Nom.	Wt. Rim Only
			Outside Diameter	Pitch Diameter				L <sub>1</sub>	C	E	L <sub>2</sub>		
17	DS60P17H	P1	4.460	4.002	1/2	1 3/4	B	1 15/16	1 31/64	3 3/32	1 15/16	0.459	3.9
19	DS60P19H	P1	4.950	4.557	1/2	1 3/4	B	1 15/16	1 31/64	3 3/64	1 15/16	0.459	5.3
21	DS60Q21H	Q1	5.430	5.032	3/4	2 1/16	B	1 15/16	1 31/64	4 1/16	2 1/2	0.459	5.4
22	DS60Q22H	Q1	5.670	5.270	3/4	2 1/16	B	1 15/16	1 31/64	4 2/64	2 1/2	0.459	6.2
23	DS60Q23H	Q1	5.910	5.508	3/4	2 1/16	B	1 15/16	1 31/64	4 3/64	2 1/2	0.459	6.9
24	DS60Q24H	Q1	6.150	5.746	3/4	2 1/16	B	1 15/16	1 31/64	4 29/32	2 1/2	0.459	7.6

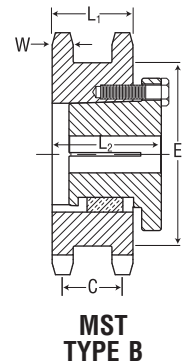



STAINLESS STEEL

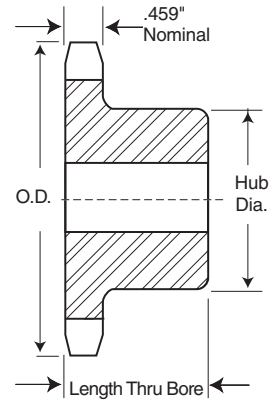

TYPE B

### Single - Type B — Stainless

### Single - Type A

No. Teeth	Catalog Number	Outside Diameter	Type	Bore (inches)		Hub (inches)		Weight Lbs. (Approx.)	Type	Catalog Number	Stock Bore	Weight Lbs. (Appl.)
				Stock	Rec. Max.	Diameter	Length Thru					
8	60B8SS	2.261	B	5/8	5/8	1 1/2★	1 1/4	0.54	—	—	—	—
9	60B9SS	2.511	B	3/4	7/8	1 1/8★	1 1/4	0.64	—	—	—	—
10	60B10SS	2.759	B	3/4	1 1/8	1 1/8★	1 1/4	0.99	—	—	—	—
11	60B11SS	3.005	B	3/4	1 1/8	2 1/8★	1 1/4	1.16	—	—	—	—
12	60B12SS	3.249	B	3/4	1 1/8	2 3/8★	1 1/4	1.50	—	—	—	—
13	60B13SS	3.493	B	3/4	1 1/2	2 1/2	1 1/4	1.71	—	—	—	—
14	60B14SS	3.736	B	3/4	1 1/2	2 9/16	1 1/4	2.05	A	60A13SS	3/4	0.80
15	60B15SS	3.978	B	3/4	1 1/2	2 1/8	1 1/4	2.51	A	60A14SS	3/4	0.94
16	60B16SS	4.220	B	3/4	2	3 1/8	1 1/4	2.88	A	60A15SS	3/4	1.08
17	60B17SS	4.462	B	3/4	2 1/4	3 1/4	1 1/4	3.27	A	60A16SS	3/4	1.24
18	60B18SS	4.703	B	3/4	2 1/2	3 1/2	1 1/4	3.77	A	60A17SS	3/4	1.44
19	60B19SS	4.945	B	3/4	2 1/2	3 1/2	1 1/4	3.98	A	60A18SS	3/4	1.62
20	60B20SS	5.186	B	3/4	2 1/2	3 3/8	1 1/4	4.69	A	60A20SS	3/4	1.84
21	60B21SS	5.426	B	3/4	2 1/2	4	1 1/4	5.10	A	60A21SS	3/4	2.34
22	60B22SS	5.666	B	3/4	2 1/2	4	1 1/4	5.34	A	60A22SS	3/4	2.56
23	60B23SS	5.907	B	3/4	2 1/2	4	1 1/4	5.59	A	60A23SS	3/4	2.81
24	60B24SS	6.147	B	3/4	2 1/2	4	1 1/4	5.59	A	60A24SS	29/32	3.08
25	60B25SS	6.387	B	3/4	2 1/2	4	1 1/4	6.13	A	60A25SS	29/32	3.35
26	60B26SS	6.627	B	3/4	2 1/2	4	1 1/4	6.42	A	60A26SS	29/32	3.67
28	60B28SS	7.106	B	3/4	2 1/2	4	1 1/4	7.03	A	60A28SS	29/32	4.28
30	60B30SS	7.586	B	3/4	2 1/2	4	1 1/4	7.69	A	60A30SS	29/32	4.94
32	60B32SS	8.065	B	3/4	2 1/2	4	1 1/4	5.26	A	60A32SS	29/32	5.52
35	60B35SS	8.783	B	1	2 1/2	4	1 1/4	9.41	A	60A35SS	15/16	6.74
36	60B36SS	9.023	B	1	2 1/2	4	1 1/4	9.60	A	60A36SS	15/16	6.82
40	60B40SS	9.980	B	1	2 1/2	4 1/4	1 1/4	11.91	A	60A40SS	15/16	8.88
45	60B45SS	11.176	B	1	2 1/2	4 1/4	1 1/4	14.34	A	60A45SS	15/16	11.30
60	60B60SS	14.761	B	1 1/4	2 1/2	4 1/4	1 1/4	25.05	A	60A60SS	1 1/4	20.08

★ Has recessed groove in hub for chain clearance.

Maximum bores shown will accommodate standard keyseat and setscrew over keyseat. Slightly larger bores are possible with no keyseat, shallow keyseat, or setscrew at angle to keyseat.

Sprockets altered at factory (rebored with keyway and setscrew added) will be supplied with stainless setscrew.

#### Alteration Charges

See current discount sheet for alteration charges.

# No. 60

## 3/4" Pitch

# All Steel Stock Sprockets

# Martin

### Single - Type B

### Single - Type A

No. Teeth	Catalog Number	Outside Diameter	Type	Bore (inches)		Hub (inches)		Weight Lbs (Approx.)	Type	Catalog Number	Stock Bore	Weight Lbs. (Approx.)
				Stock	Rec. Max.	Diameter	Length Thru					
8	60B8	2.260	B	3/8	3/8	1 15/16★	1 1/4	0.54	-	-	-	-
9	60B9	2.510	B	3/8	3/8	1 15/16★	1 1/4	0.64	-	-	-	-
10	60B10	2.760	B	3/8	1 1/8	1 15/16★	1 1/4	0.99	A	60A10	3/8	0.44
11	60B11	3.000	B	3/8	1 1/8	2 1/16★	1 1/4	1.16	A	60A11	3/8	0.54
12	60B12	3.250	B	3/8	1 1/8	2 3/16★	1 1/4	1.47	A	60A12	3/8	0.68
13	60B13	3.490	B	3/8	1 1/2	2 1/2	1 1/4	1.66	A	60A13	3/8	0.80
14	60B14	3.740	B	3/8	1 1/2	2 5/16	1 1/4	2.00	A	60A14	3/8	0.94
15	60B15	3.980	B	3/8	1 1/2	2 3/8	1 1/4	2.51	A	60A15	3/8	1.08
16	60B16	4.220	B	3/8	2	3 1/16	1 1/4	2.81	A	60A16	3/8	1.24
17	60B17	4.460	B	3/8	2 1/4	3 1/4	1 1/4	3.22	A	60A17	3/8	1.44
18	60B18	4.700	B	3/8	2 1/2	3 3/8	1 1/4	3.72	A	60A18	3/8	1.62
19	60B19	4.950	B	3/8	2 3/4	3 3/4	1 1/4	3.92	A	60A19	3/8	1.84
20	60B20	5.190	B	3/8	2 3/4	3 3/8	1 1/4	4.63	A	60A20	3/8	2.12
21	60B21	5.430	B	3/8	2 3/4	4	1 1/4	5.00	A	60A21	3/8	2.28
22	60B22	5.670	B	3/8	2 3/4	4	1 1/4	5.25	A	60A22	3/8	2.48
23	60B23	5.910	B	3/8	2 3/4	4	1 1/4	5.48	A	60A23	3/8	2.68
24	60B24	6.150	B	3/8	2 3/4	4	1 1/4	5.78	A	60A24	3/8	3.00
25	60B25	6.390	B	3/8	2 3/4	4	1 1/4	6.13	A	60A25	3/8	3.34
26	60B26	6.630	B	3/8	2 3/4	4	1 1/4	6.38	A	60A26	3/8	3.54
27	60B27	6.870	B	3/8	2 3/4	4	1 1/4	6.72	A	60A27	3/8	3.96
28	60B28	7.110	B	3/8	2 3/4	4	1 1/4	6.88	A	60A28	3/8	4.14
29	60B29	7.350	B	3/8	2 3/4	4	1 1/4	7.28	A	60A29	3/8	4.40
30	60B30	7.590	B	3/8	2 3/4	4	1 1/4	7.58	A	60A30	3/8	4.78
31	60B31	7.830	B	3/8	2 3/4	4	1 1/4	7.72	A	60A31	3/8	5.24
32	60B32	8.070	B	3/8	2 3/4	4	1 1/4	8.26	A	60A32	3/8	5.52
33	60B33	8.300	B	1	2 3/4	4	1 1/4	8.42	A	60A33	3/8	5.86
34	60B34	8.540	B	1	2 3/4	4	1 1/4	8.80	A	60A34	3/8	6.16
35	60B35	8.780	B	1	2 3/4	4	1 1/4	9.04	A	60A35	3/8	6.78
36	60B36	9.020	B	1	2 3/4	4	1 1/4	9.60	A	60A36	3/8	6.82
37	60B37	9.260	B	1	2 3/4	4	1 1/4	10.24	A	60A37	3/8	7.52
38	60B38	9.500	B	1	2 3/4	4 1/4	1 1/4	10.84	A	60A38	3/8	7.84
39	60B39	9.740	B	1	2 3/4	4 1/4	1 1/4	11.36	A	60A39	3/8	8.28
40	60B40	9.980	B	1	2 3/4	4 1/4	1 1/4	11.50	A	60A40	3/8	8.56
41	60B41	10.220	B	1	2 3/4	4 1/4	1 1/4	12.14	A	60A41	3/8	9.10
42	60B42	10.460	B	1	2 3/4	4 1/4	1 1/4	12.74	A	60A42	3/8	9.84
43	60B43	10.700	B	1	2 3/4	4 1/4	1 1/4	13.00	A	60A43	3/8	9.74
44	60B44	10.940	B	1 1/16	2 3/4	4 1/4	1 1/4	13.88	A	60A44	3/8	10.76
45	60B45	11.180	B	1 1/16	2 3/4	4 1/4	1 1/4	13.98	A	60A45	3/8	11.08
46	60B46	11.420	B	1 1/16	2 3/4	4 1/4	1 1/4	14.60	A	60A46	3/8	11.50
47	60B47	11.650	B	1 1/16	2 3/4	4 1/4	1 1/4	15.00	A	60A47	3/8	12.32
48	60B48	11.890	B	1 1/16	2 3/4	4 1/4	1 1/4	15.82	A	60A48	3/8	12.42
49	60B49	12.130	B	1 1/16	2 3/4	4 1/4	1 1/4	15.90	A	60A49	3/8	12.92
50	60B50	12.370	B	1 1/16	2 3/4	4 1/4	1 1/4	17.66	A	60A50	3/8	13.98
51	60B51	12.610	B	1 1/16	2 3/4	4 1/4	1 1/4	16.98	A	60A51	3/8	14.58
52	60B52	12.850	B	1 1/16	2 3/4	4 1/4	1 1/4	17.93	A	60A52	3/8	14.60
53	60B53	13.090	B	1 1/16	2 3/4	4 1/4	1 1/4	17.99	A	60A53	3/8	15.84
54	60B54	13.330	B	1 1/16	2 3/4	4 1/4	1 1/4	21.60	A	60A54	3/8	15.92
55	60B55	13.570	B	1 1/4	2 3/4	4 1/4	1 1/4	21.14	A	60A55	1 1/4	16.96
56	60B56	13.810	B	1 1/4	2 3/4	4 1/4	1 1/4	21.88	A	60A56	1 1/4	17.60
57	60B57	14.040	B	1 1/4	2 3/4	4 1/4	1 1/4	22.26	A	60A57	1 1/4	17.62
58	60B58	14.280	B	1 1/4	2 3/4	4 1/4	1 1/4	22.80	A	60A58	1 1/4	19.00
59	60B59	14.520	B	1 1/4	2 3/4	4 1/4	1 1/4	23.86	A	60A59	1 1/4	19.20
60	60B60	14.760	B	1 1/4	2 3/4	4 1/4	1 1/4	25.22	A	60A60	1 1/4	20.02
64	60B64	15.720	B	1 1/4	2 3/4	4 1/4	1 1/4	27.40	A	60A64	1 1/4	23.00
65	60B65	15.960	B	1 1/4	2 3/4	4 1/4	1 1/4	28.92	A	60A65	1 1/4	23.24
66	-	-	-	-	-	-	-	-	A	60A66	1 1/4	24.42
68	60B68	16.670	B	1 1/4	2 3/4	4 1/4	1 1/4	30.38	A	60A68	1 1/4	25.54
70	60B70	17.150	B	1 1/4	2 3/4	4 1/4	1 1/4	31.98	A	60A70	1 1/4	27.20
72	60B72	17.630	B	1 1/4	2 3/4	4 1/4	2	34.18	A	60A72	1 1/4	28.90
76	60B76	18.580	B	1 1/4	2 3/4	4 1/4	2	38.06	A	60A76	1 1/4	32.34
80	60B80	19.540	B	1 1/4	2 3/4	4 1/4	2	41.88	A	60A80	1 1/4	45.50
84	60B84	20.490	B	1 1/4	3 3/8	4 3/8	2	46.46	A	60A84	1 1/4	40.18
90	60B90	21.930	B	1 1/4	3 3/8	5	2 1/4	63.20	A	60A90	1 1/4	43.44
96	60B96	23.360	B	1 1/4	3 3/8	5 1/2	2 1/4	63.08	A	60A96	1 1/4	52.02
112	60B112	27.180	B	1 1/4	3 3/8	5 1/2	2 1/4	81.78	A	60A112	1 1/4	70.80

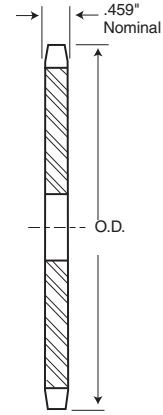

TYPE A

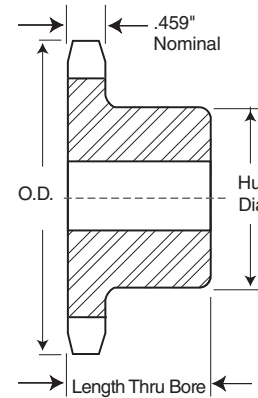

TYPE B

#### Alteration Charges

See current discount sheet for alteration charges.

★ Has recessed groove in hub for chain clearance.

Maximum bores shown will accommodate standard keyseat and setscrew over keyseat. Slightly larger bores are possible with no keyseat, shallow keyseat, or setscrew at angle to keyseat.

# Martin

## All Steel Stock Sprockets

# No. 60

## 3/4" Pitch

### Single - Type QD With Hardened Teeth

No. Teeth	Catalog Number
11	60JA11H
12	60JA12H
13	60JA13H
14	60SH14H
15	60SH15H
16	60SH16H
17	60SDS17H
18	60SDS18H
19	60SDS19H
20	60SDS20H
21	60SDS21H
22	60SDS22H
23	60SDS23H
24	60SDS24H
25	60SDS25H
26	60SK26H
27	60SK27H
28	60SK28H
30	60SK30H

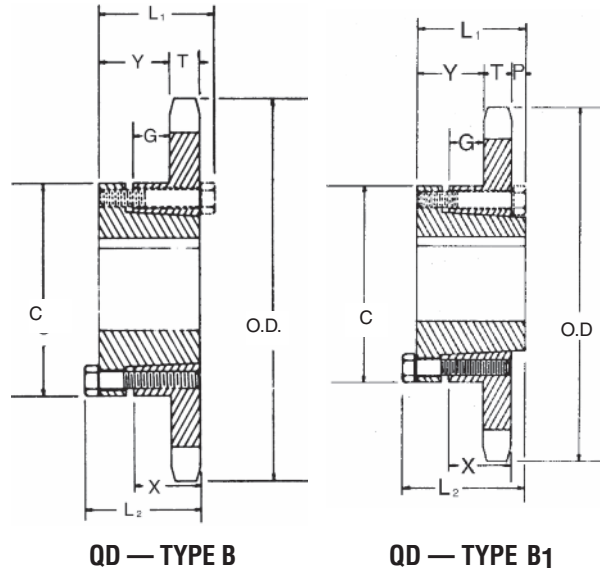

SABER  
TOOTH®



### Single - Type QD

No. Teeth	Catalog Number	Bush- ing	Diameters		Type	Max. Bore	Dimensions						Weight Lbs. (Approx.)		
			Outside Diameter	Pitch Diameter			L <sub>1</sub>	L <sub>2</sub>	C	Y	G	X	T	With Hub	Rim Only
11	60JA11	JA	3.000	2.662	B	1 1/4	1 1/8	1 1/8	2 1/16	35/64	11/64	5/8	0.459	1.36	0.46
12	60JA12	JA	3.250	2.898	B	1 1/4	1 1/8	1 1/8	2 1/16	35/64	11/64	5/8	0.459	1.50	0.60
13	60JA13	JA	3.490	3.134	B	1 1/4	1 1/8	1 1/8	2 1/16	35/64	11/64	5/8	0.459	1.66	0.76
14	60SH14	SH	3.740	3.371	B	1 1/8	1 1/16	1 1/16	2 1/16	51/64	23/64	13/16	0.459	1.88	0.88
15	60SH15	SH	3.980	3.607	B	1 1/8	1 1/16	1 1/16	2 1/16	51/64	23/64	13/16	0.459	2.08	1.08
16	60SH16	SH	4.220	3.844	B	1 1/8	1 1/16	1 1/16	2 1/16	51/64	23/64	13/16	0.459	2.26	1.26
17	60SDS17	SDS	4.460	4.082	B	2	1 1/2	1 1/2	3 3/16	55/64	19/64	3/4	0.459	2.38	1.38
18	60SDS18	SDS	4.700	4.319	B	2	1 1/2	1 1/2	3 3/16	55/64	19/64	3/4	0.459	2.56	1.56
19	60SDS19	SDS	4.950	4.557	B	2	1 1/2	1 1/2	3 3/16	55/64	19/64	3/4	0.459	2.76	1.76
20	60SDS20	SDS	5.190	4.794	B	2	1 1/2	1 1/2	3 3/16	55/64	19/64	3/4	0.459	3.00	2.00
21	60SDS21	SDS	5.430	5.032	B	2	1 1/2	1 1/2	3 3/16	55/64	19/64	3/4	0.459	3.20	2.20
22	60SDS22	SDS	5.670	5.270	B	2	1 1/2	1 1/2	3 3/16	55/64	19/64	3/4	0.459	3.44	2.44
23	60SDS23	SDS	5.910	5.508	B	2	1 1/2	1 1/2	3 3/16	55/64	19/64	3/4	0.459	3.70	2.70
24	60SDS24	SDS	6.150	5.746	B	2	1 1/2	1 1/2	3 3/16	55/64	19/64	3/4	0.459	3.94	2.94
25	60SDS25	SDS	6.390	5.984	B	2	1 1/2	1 1/2	3 3/16	55/64	19/64	3/4	0.459	4.24	3.24
26	60SK26	SK	6.630	6.222	B	2 3/8	2 1/8	2 1/8	3 3/8	1 27/64	51/64	1 1/4	0.459	6.18	4.18
27	60SK27	SK	6.870	6.460	B	2 3/8	2 1/8	2 1/8	3 3/8	1 27/64	51/64	1 1/4	0.459	6.52	4.52
28	60SK28	SK	7.110	6.699	B	2 3/8	2 1/8	2 1/8	3 3/8	1 27/64	51/64	1 1/4	0.459	6.72	4.72
30	60SK30	SK	7.590	7.175	B	2 3/8	2 1/8	2 1/8	3 3/8	1 27/64	51/64	1 1/4	0.459	7.34	5.34
32	60SK32	SK	8.070	7.652	B	2 3/8	2 1/8	2 1/8	3 3/8	1 27/64	51/64	1 1/4	0.459	8.10	6.10
35	60SK35	SK	8.780	8.367	B	2 3/8	2 1/8	2 1/8	3 3/8	1 27/64	51/64	1 1/4	0.459	9.42	7.42
36	60SK36	SK	9.020	8.605	B	2 3/8	2 1/8	2 1/8	3 3/8	1 27/64	51/64	1 1/4	0.459	9.70	7.70
40	60SK40	SK	9.980	9.559	B	2 3/8	2 1/8	2 1/8	3 3/8	1 27/64	51/64	1 1/4	0.459	11.56	9.56
42	60SF42	SF	10.460	10.036	B	2 3/16	2 1/4	2 1/4	4 3/8	1 35/64	51/64	1 1/4	0.459	13.78	10.78
45	60SF45	SF	11.180	10.752	B	2 3/16	2 1/4	2 1/4	4 3/8	1 35/64	51/64	1 1/4	0.459	15.40	12.40
48	60SF48	SF	11.890	11.467	B	2 3/16	2 1/4	2 1/4	4 3/8	1 35/64	51/64	1 1/4	0.459	17.26	14.26
54	60SF54	SF	13.330	12.899	B	2 3/16	2 1/4	2 1/4	4 3/8	1 35/64	51/64	1 1/4	0.459	20.02	17.02
60	60SF60	SF	14.760	14.331	B	2 3/16	2 1/4	2 1/4	4 3/8	1 35/64	51/64	1 1/4	0.459	23.76	20.76
70	60SF70	SF	17.150	16.717	B	2 3/16	2 1/4	2 1/4	4 3/8	1 35/64	51/64	1 1/4	0.459	31.60	28.60
72	60SF72	SF	17.630	17.194	B	2 3/16	2 1/4	2 1/4	4 3/8	1 35/64	51/64	1 1/4	0.459	32.58	29.58
80	60SF80	SF	19.540	19.103	B	2 3/16	2 1/4	2 1/4	4 3/8	1 35/64	51/64	1 1/4	0.459	41.24	38.24
84	60SF84	SF	20.490	20.058	B	2 3/16	2 1/4	2 1/4	4 3/8	1 35/64	51/64	1 1/4	0.459	43.94	40.94
96	60SF96	SF	23.360	22.922	B	2 3/16	2 1/4	2 1/4	4 3/8	1 35/64	51/64	1 1/4	0.459	55.40	52.40
112	60E112	E	27.180	26.742	B1	3 1/2	2 3/8	2 3/8	6	2 3/16	1 11/64	1 1/8	0.459	83.76	73.76

# No. 60 Pitch $\frac{3}{4}$ "

# All Steel Stock Sprockets

# Martin

## Single - Taper Bushed with Hardened Teeth

No. Teeth	Catalog Number
11	60BTB11H
12	60BTB12H
13	60BTB13H
14	60BTB14H
15	60BTB15H
16	60BTB16H
17	60BTB17H
18	60BTB18H
19	60BTB19H
20	60BTB20H
21	60BTB21H
22	60BTB22H
23	60BTB23H
24	60BTB24H
25	60BTB25H
26	60BTB26H
27	60BTB27H
28	60BTB28H
30	60BTB30H

**SABER  
TOOTH®**

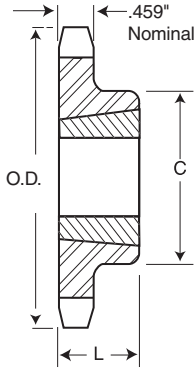

**TAPER BUSH  
TYPE B**

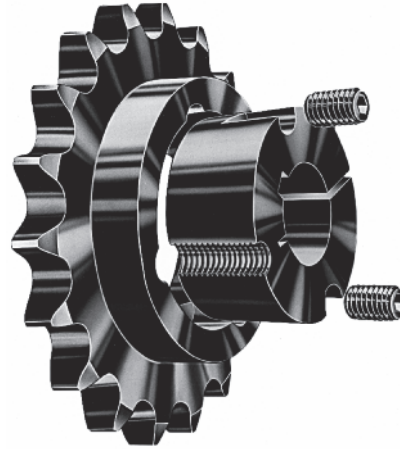

## Single - Taper Bushed

No. Teeth	Catalog Number	Bushing	Diameters		Max. Bore	Dimensions		Type	Weight Lbs. (Approx.)	
			Outside Diameter	Pitch Diameter		L	C		Rim Only	Bushing Only
11	60BTB11	1008	3.004	2.662	1	$\frac{7}{8}$	$1\frac{1}{16}$	B	0.6	0.3
12	60BTB12	1008	3.249	2.898	1	$\frac{7}{8}$	$1\frac{1}{16}$	B	0.8	0.3
13	60BTB13	1210	3.493	3.134	$1\frac{1}{4}$	1	$2\frac{15}{32}$ *	B	0.8	0.6
14	60BTB14	1210	3.736	3.371	$1\frac{1}{4}$	1	$2\frac{19}{32}$	B	1.0	0.6
15	60BTB15	1610	3.979	3.607	$1\frac{1}{2}$	1	$2\frac{25}{32}$	B	1.0	0.9
16	60BTB16	1610	4.221	3.844	$1\frac{1}{2}$	1	3	B	1.4	0.9
17	60BTB17	1610	4.462	4.082	$1\frac{1}{2}$	1	$3\frac{1}{4}$	B	1.8	0.9
18	60BTB18	1610	4.704	4.319	$1\frac{1}{2}$	1	$3\frac{1}{2}$	B	1.9	0.9
19	60BTB19	1610	4.945	4.557	$1\frac{1}{2}$	1	$3\frac{1}{2}$	B	2.2	0.9
20	60BTB20	2012	5.185	4.794	2	$1\frac{1}{4}$	$3\frac{15}{16}$	B	2.2	1.7
21	60BTB21	2012	5.426	5.032	2	$1\frac{1}{4}$	4	B	2.5	1.7
22	60BTB22	2012	5.666	5.270	2	$1\frac{1}{4}$	4	B	2.8	1.7
23	60BTB23	2012	5.907	5.508	2	$1\frac{1}{4}$	4	B	3.1	1.7
24	60BTB24	2012	6.147	5.746	2	$1\frac{1}{4}$	$3\frac{3}{16}$	B	3.4	1.7
25	60BTB25	2012	6.387	5.984	2	$1\frac{1}{4}$	$3\frac{3}{16}$	B	3.7	1.7
26	60BTB26	2012	6.627	6.222	2	$1\frac{1}{4}$	$3\frac{3}{16}$	B	4.0	1.7
27	60BTB27	2012	6.867	6.416	2	$1\frac{1}{4}$	$3\frac{3}{16}$	B	4.2	1.7
28	60BTB28	2012	7.107	6.699	2	$1\frac{1}{4}$	$3\frac{3}{16}$	B	4.6	1.7
30	60BTB30	2012	7.586	7.175	2	$1\frac{1}{4}$	$3\frac{3}{16}$	B	5.2	1.7
32	60BTB32	2012	8.065	7.652	2	$1\frac{1}{4}$	$3\frac{3}{16}$	B	5.6	1.7
35	60BTB35	2012	8.783	8.367	2	$1\frac{1}{4}$	$3\frac{3}{16}$	B	6.4	1.7
36	60BTB36	2012	9.022	8.605	2	$1\frac{1}{4}$	$3\frac{3}{16}$	B	6.6	1.7
40	60BTB40	2012	9.980	9.559	2	$1\frac{1}{4}$	$3\frac{3}{16}$	B	8.3	1.7
42	60BTB42	2012	10.458	10.036	2	$1\frac{1}{4}$	$3\frac{3}{16}$	B	10.0	1.7
45	60BTB45	2012	11.175	10.752	2	$1\frac{1}{4}$	$3\frac{3}{16}$	B	11.5	1.7
48	60BTB48	2012	11.893	11.467	2	$1\frac{1}{4}$	$3\frac{3}{16}$	B	13.2	1.7
54	60BTB54	2517	13.327	12.899	$2\frac{1}{2}$	$1\frac{1}{4}$	$4\frac{1}{4}$	B	17.1	3.5
60	60BTB60	2517	14.761	14.330	$2\frac{1}{2}$	$1\frac{1}{4}$	$4\frac{1}{4}$	B	21.0	3.5
70	60BTB70	2517	17.150	16.717	$2\frac{1}{2}$	$1\frac{1}{4}$	$4\frac{1}{4}$	B	27.6	3.5
72	60BTB72	2517	17.628	17.194	$2\frac{1}{2}$	$1\frac{1}{4}$	$4\frac{1}{4}$	B	30.0	3.5
80	60BTB80	2517	19.539	19.103	$2\frac{1}{2}$	$1\frac{1}{4}$	$4\frac{1}{4}$	B	36.3	3.5
84	60BTB84	2517	20.494	20.058	$2\frac{1}{2}$	$1\frac{1}{4}$	$4\frac{1}{4}$	B	40.6	3.5

\* Has recessed groove in hub for chain clearance.

### Single - MST<sup>®</sup> Sprockets

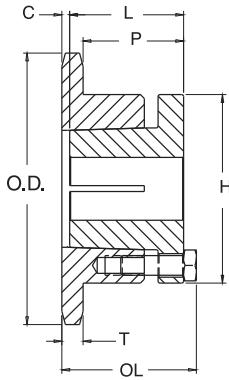

**TYPE 3**

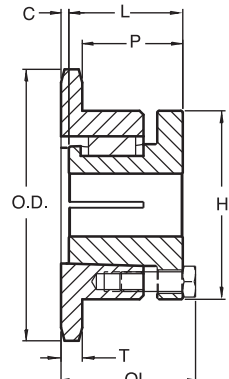

**TYPE 4**

No. Teeth	Catalog Number	Bush-ing	Diameters		Type	Max. Bore	Dimensions						Weight Lbs. (Approx.)	
			Outside Dia.	Pitch Dia.			OL	L	C	H	P	T(nom)	With Hub	Rim Only
11	60H11H	H	3.000	2.662	3	1-1/2	1-13/16	1-1/4	3/8	2-1/2	1-5/32	0.459	1.5	0.7
12	60H12H	H	3.250	2.898	3	1-1/2	1-3/4	1-1/4	5/16	2-1/2	1-3/32	0.459	1.6	0.8
13	60H13H	H	3.490	3.134	3	1-1/2	1-1/2	1-1/4	1/16	2-1/2	27/32	0.459	1.6	0.8
13	60P13H	P1	3.490	3.134	4	1-3/4	2-3/16	1-15/16	-	3	1-15/32	0.459	2.5	1.2
14	60H14H	H	3.740	3.371	3	1-1/2	1-1/2	1-1/4	1/16	2-1/2	27/32	0.459	1.9	1.1
14	60P14H	P1	3.740	3.371	4	1-3/4	2-3/16	1-15/16	-	3	1-15/32	0.459	2.7	1.4
15	60H15H	H	3.980	3.607	3	1-1/2	1-1/2	1-1/4	1/16	2-1/2	27/32	0.459	2.2	1.4
15	60P15H	P1	3.980	3.607	4	1-3/4	2-3/16	1-15/16	-	3	1-15/32	0.459	3.0	1.7
16	60H16H	H	4.220	3.844	3	1-1/2	1-1/2	1-1/4	1/16	2-1/2	27/32	0.459	2.1	1.3
16	60P16H	P1	4.220	3.844	4	1-3/4	2-3/16	1-15/16	-	3	1-15/32	0.459	3.1	1.8
17	60H17H	H	4.460	4.082	3	1-1/2	1-1/2	1-1/4	1/16	2-1/2	27/32	0.459	2.3	1.5
17	60P17H	P1	4.460	4.082	4	1-3/4	2-3/16	1-15/16	-	3	1-15/32	0.459	3.4	2.1
18	60H18H	H	4.700	4.319	3	1-1/2	1-1/2	1-1/4	1/16	2-1/2	27/32	0.459	2.5	1.7
18	60P18H	P1	4.700	4.319	4	1-3/4	2-3/16	1-15/16	-	3	1-15/32	0.459	3.5	2.2
19	60H19H	H	4.950	4.557	3	1-1/2	1-1/2	1-1/4	1/16	2-1/2	27/32	0.459	2.7	1.9
19	60P19H	P1	4.950	4.557	4	1-3/4	2-3/16	1-15/16	-	3	1-15/32	0.459	3.8	2.5
20	60H20H	H	5.190	4.794	3	1-1/2	1-1/2	1-1/4	1/16	2-1/2	27/32	0.459	2.9	2.1
20	60P20H	P1	5.190	4.794	4	1-3/4	2-3/16	1-15/16	-	3	1-15/32	0.459	4.4	3.1
20	60Q20H	Q1	5.190	4.794	4	2-11/16	2-25/32	2-1/2	-	4-1/8	2-1/32	0.459	7.0	3.5
21	60P21H	P1	5.430	5.032	4	1-3/4	2-3/16	1-15/16	-	3	1-15/32	0.459	4.2	2.9
21	60Q21H	Q1	5.430	5.032	4	2-11/16	2-25/32	2-1/2	-	4-1/8	2-1/32	0.459	7.1	3.6
22	60H22H	H	5.670	5.270	3	1-1/2	1-1/2	1-1/4	1/16	2-1/2	27/32	0.459	3.4	2.6
22	60P22H	P1	5.670	5.270	4	1-3/4	2-3/16	1-15/16	-	3	1-15/32	0.459	4.5	3.2
22	60Q22H	Q1	5.670	5.270	4	2-11/16	2-25/32	2-1/2	-	4-1/8	2-1/32	0.459	7.5	4.0
23	60P23H	P1	5.910	5.508	4	1-3/4	2-3/16	1-15/16	-	3	1-15/32	0.459	4.8	3.5
23	60Q23H	Q1	5.910	5.508	4	2-11/16	2-25/32	2-1/2	-	4-1/8	2-1/32	0.459	7.6	4.1
24	60H24H	H	6.150	5.746	3	1-1/2	1-1/2	1-1/4	1/16	2-1/2	27/32	0.459	3.8	3.0
24	60P24H	P1	6.150	5.746	4	1-3/4	2-3/16	1-15/16	-	3	1-15/32	0.459	5.1	3.8
24	60Q24H	Q1	6.150	5.746	4	2-11/16	2-25/32	2-1/2	-	4-1/8	2-1/32	0.459	8.0	4.5
25	60P25H	P1	6.390	5.984	4	1-3/4	2-3/16	1-15/16	-	3	1-15/32	0.459	5.4	4.1
25	60Q25H	Q1	6.390	5.984	4	2-11/16	2-25/32	2-1/2	-	4-1/8	2-1/32	0.459	9.4	5.9
26	60P26H	P1	6.630	6.222	4	1-3/4	2-3/16	1-15/16	-	3	1-15/32	0.459	5.6	4.3
26	60Q26H	Q1	6.630	6.222	4	2-11/16	2-25/32	2-1/2	-	4-1/8	2-1/32	0.459	9.8	6.3
27	60P27H	P1	6.870	6.460	4	1-3/4	2-3/16	1-15/16	-	3	1-15/32	0.459	5.8	4.5
27	60Q27H	Q1	6.870	6.460	4	2-11/16	2-25/32	2-1/2	-	4-1/8	2-1/32	0.459	9.9	6.4
28	60P28H	P1	7.110	6.699	4	1-3/4	2-3/16	1-15/16	-	3	1-15/32	0.459	6.2	4.9
28	60Q28H	Q1	7.110	6.699	4	2-11/16	2-25/32	2-1/2	-	4-1/8	2-1/32	0.459	10.4	6.9
29	60Q29H	Q1	7.350	6.937	4	2-11/16	2-25/32	2-1/2	-	4-1/8	2-1/32	0.459	10.8	7.3
30	60P30H	P1	7.590	7.175	4	1-3/4	2-3/16	1-15/16	-	3	1-15/32	0.459	6.9	5.6
30	60Q30H	Q1	7.590	7.175	4	2-11/16	2-25/32	2-1/2	-	4-1/8	2-1/32	0.459	11.1	7.6
31	60Q31	Q1	7.830	7.413	4	2-11/16	2-25/32	2-1/2	-	4-1/8	2-1/32	0.459	11.3	7.8
32	60Q32	Q1	8.070	7.652	4	2-11/16	2-25/32	2-1/2	-	4-1/8	2-1/32	0.459	11.8	8.3
33	60Q33	Q1	8.300	7.890	4	2-11/16	2-25/32	2-1/2	-	4-1/8	2-1/32	0.459	12.2	8.7
34	60Q34	Q1	8.540	8.129	4	2-11/16	2-25/32	2-1/2	-	4-1/8	2-1/32	0.459	12.6	9.1
35	60Q35	Q1	8.780	8.367	4	2-11/16	2-25/32	2-1/2	-	4-1/8	2-1/32	0.459	12.8	9.3
36	60Q36	Q1	9.020	8.605	4	2-11/16	2-25/32	2-1/2	-	4-1/8	2-1/32	0.459	13.4	9.9
37	60Q37	Q1	9.260	8.844	4	2-11/16	2-25/32	2-1/2	-	4-1/8	2-1/32	0.459	13.8	10.3
38	60Q38	Q1	9.500	9.082	4	2-11/16	2-25/32	2-1/2	-	4-1/8	2-1/32	0.459	14.1	10.6
39	60Q39	Q1	9.740	9.321	4	2-11/16	2-25/32	2-1/2	-	4-1/8	2-1/32	0.459	14.6	11.1
40	60Q40	Q1	9.980	9.559	4	2-11/16	2-25/32	2-1/2	-	4-1/8	2-1/32	0.459	15.1	11.6
41	60Q41	Q1	10.220	9.798	4	2-11/16	2-25/32	2-1/2	-	4-1/8	2-1/32	0.459	15.4	11.9
42	60Q42	Q1	10.460	10.036	4	2-11/16	2-25/32	2-1/2	-	4-1/8	2-1/32	0.459	16.1	12.6
44	60Q44	Q1	10.940	10.513	4	2-11/16	2-25/32	2-1/2	-	4-1/8	2-1/32	0.459	16.9	13.4
45	60Q45	Q1	11.180	10.752	4	2-11/16	2-25/32	2-1/2	-	4-1/8	2-1/32	0.459	17.4	13.9
47	60Q47	Q1	11.650	11.229	4	2-11/16	2-25/32	2-1/2	-	4-1/8	2-1/32	0.459	19.8	16.3
48	60Q48	Q1	11.890	11.467	4	2-11/16	2-25/32	2-1/2	-	4-1/8	2-1/32	0.459	19.9	16.4
50	60Q50	Q1	12.370	11.945	4	2-11/16	2-25/32	2-1/2	-	4-1/8	2-1/32	0.459	20.4	16.9
54	60Q54	Q1	13.330	12.899	4	2-11/16	2-25/32	2-1/2	-	4-1/8	2-1/32	0.459	23.1	19.6
56	60Q56	Q1	13.810	13.376	4	2-11/16	2-25/32	2-1/2	-	4-1/8	2-1/32	0.459	23.8	20.3
60	60Q60	Q1	14.760	14.331	4	2-11/16	2-25/32	2-1/2	-	4-1/8	2-1/32	0.459	26.4	22.9
70	60Q70	Q1	17.150	16.717	4	2-11/16	2-25/32	2-1/2	-	4-1/8	2-1/32	0.459	34.4	30.9
70	60R70	R1	17.150	16.717	4	3-3/4	3-5/32	2-7/8	-	5-3/8	2-13/32	0.459	39.3	31.8
72	60Q72	Q1	17.630	17.194	4	2-11/16	2-25/32	2-1/2	-	4-1/8	2-1/32	0.459	35.4	31.9
72	60R72	R1	17.630	17.194	4	3-3/4	3-5/32	2-7/8	-	5-3/8	2-13/32	0.459	41.6	34.1
80	60Q80	Q1	19.540	19.103	4	2-11/16	2-25/32	2-1/2	-	4-1/8	2-1/32	0.459	42.6	39.1
80	60R80	R1	19.540	19.103	4	3-3/4	3-5/32	2-7/8	-	5-3/8	2-13/32	0.459	49.0	41.5
84	60Q84	Q1	20.490	20.058	4	2-11/16	2-25/32	2-1/2	-	4-1/8	2-1/32	0.459	45.1	41.6
84	60R84	R1	20.490	20.058	4	3-3/4	3-5/32	2-7/8	-	5-3/8	2-13/32	0.459	52.3	44.8
96	60Q96	Q1	23.360	22.922	4	2-11/16	2-25/32	2-1/2	-	4-1/8	2-1/32	0.459	57.5	54.0
96	60R96	R1	23.360	22.922	4	3-3/4	3-5/32	2-7/8	-	5-3/8	2-13/32	0.459	63.5	56.0
112	60Q112	Q1	27.180	26.742	4	2-11/16	2-25/32	2-1/2	-	4-1/8	2-1/32	0.459	76.5	73.0
112	60R112	R1	27.180	26.742	4	3-3/4	3-5/32	2-7/8	-	5-3/8	2-13/32	0.459	82.0	74.5

Sprockets with "H" suffix have hardened teeth.

# No. 60-2

## 3/4" Pitch

# All Steel Stock Sprockets

# Martin

## Double - Type B & C

No. Teeth	Catalog Number	Outside Diameter	Type	Bore (inches)		Hub (inches)		Weight Lbs. (Approx.)
				Stock	Rec. Max.	Dia.	Length Thru	
11	D60B11H	3.000	B	1	1 1/4	1 1/16	2 1/2	1.62
12	D60B12H	3.250	B	1	1 1/8	2 1/8	2 1/2	2.20
13	D60B13H	3.490	B	1	1 1/2	2 1/4	2 1/2	2.60
14	D60B14H	3.740	B	1	1 1/4	2 1/2	2 1/2	3.24
15	D60B15H	3.980	B	1	1 1/4	2 5/16	2 1/2	3.96
16	D60B16H	4.220	B	1	2	3	2 1/2	4.62
17	D60B17H	4.460	B	1	2 1/4	3 1/4	2 1/2	5.40
18	D60B18H	4.700	B	1	2 1/2	3 1/2	2 1/2	6.24
19	D60B19H	4.950	B	1	2 1/2	3 7/16	2 1/2	7.00
20	D60B20H	5.190	B	1	2 1/2	3 3/4	2 1/2	7.72
21	D60B21H	5.430	B	1	2 1/2	4 1/8	2 1/2	8.82
22	D60B22H	5.670	B	1	2 1/2	4 1/4	2 1/2	9.68
23	D60B23H	5.910	B	1	2 1/2	4 1/2	2 1/2	10.30
24	D60B24H	6.150	B	1	2 1/2	4 3/4	2 1/2	11.14
25	D60B25H	6.390	B	1	2 1/2	4 1/2	2 1/2	11.96
26	D60B26	6.630	B	1	2 1/2	4 1/2	2 1/2	12.70
30	D60B30	7.590	B	1	2 1/2	4 1/2	2 1/2	16.36
32	D60B32	8.070	B	1 1/4	3	4 1/2	2 1/2	19.52
35	D60B35	8.780	B	1 1/4	3	4 1/2	2 1/2	22.80
36	D60B36	9.020	B	1 1/4	3	4 1/2	2 1/2	23.82
40	D60B40	9.980	B	1 1/4	3 1/4	4 3/4	2 1/2	30.84
42	D60B42	10.460	B	1 1/4	3 1/4	4 3/4	2 1/2	33.08
45	D60B45	11.180	B	1 1/4	3 1/4	4 3/4	2 1/2	37.08
52	D60B52	12.850	B	1 1/4	3 1/4	4 3/4	2 1/2	48.70
60	D60B60	14.760	B	1 1/4	3 1/4	4 3/4	2 1/2	63.10
68	D60C68	16.670	C	1 1/4	3 3/16	5	3	53.68
72	D60C72	17.630	C	1 1/4	3 3/16	5	3	53.74
76	D60C76	18.580	C	1 1/4	3 3/16	5	3	60.28
95	D60C95	23.120	C	1 1/4	3 3/4	5 1/2	3 1/2	87.14

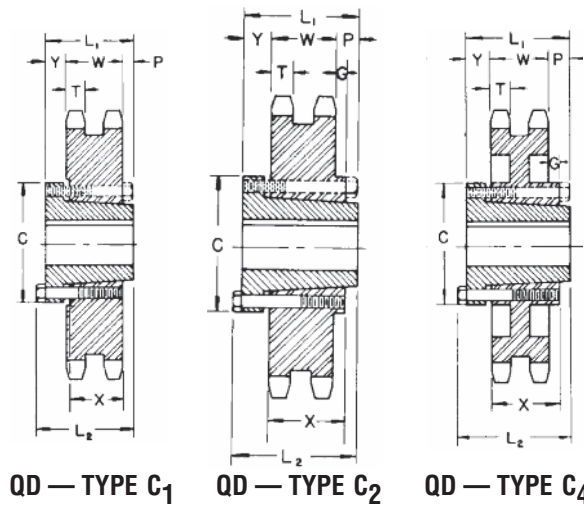
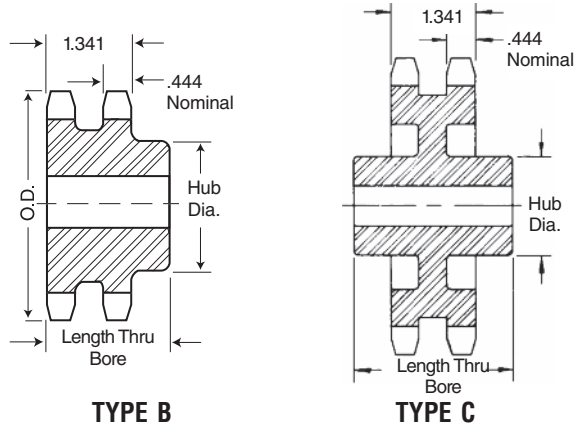

Maximum bores shown will accommodate standard keyseat and setscrew over keyseat. Slightly larger bores are possible with no keyseat, shallow keyseat, or setscrew at angle to keyseat.

NOTE: Double 60 stock sprockets with 25 teeth or less have hardened teeth. As indicated by H suffix.

**Alteration Charges**

See current discount sheet for alteration charges.

## Double - Type QD

No. Teeth	Catalog Number	Bush-ing	Diameters		Type	Max. Bore	Dimensions										Weight Lbs. (Approx.)	
			Outside Diameter	Pitch Diameter			L <sub>1</sub>	L <sub>2</sub>	C	Y	P	G	X	T	W	With Hub	Rim Only	
14	D60SH14H	SH	3.740	3.371	B★	1 1/2	1 3/32	1 3/32	2 1/16	1/2	—	—	—	—	0.444	1.341	2.50	1.50
22	D60SDS22H	SDS	5.670	5.270	B★	2	1 17/32	1 17/32	3 1/8	—	—	—	—	0.444	1.341	5.44	4.44	
36	D60SF36	SF	9.020	8.605	C1	2 5/16	2	2 1/4	4 5/8	3/4	—	—	1 1/4	0.444	1.341	19.26	16.26	
42	D60E42	E	10.460	10.036	C2	3 1/2	2 5/8	2 5/16	6	7/8	13/32	9/32	1 1/8	0.444	1.341	34.04	24.04	
45	D60E45	E	11.180	10.752	C2	3 1/2	2 5/8	2 5/16	6	7/8	13/32	9/32	1 1/8	0.444	1.341	38.26	28.36	
52	D60E52	E	12.850	12.422	C2	3 1/2	2 5/8	2 5/16	6	7/8	13/32	9/32	1 1/8	0.444	1.341	49.52	39.52	
60	D60E60	E	14.760	14.331	C2	3 1/2	2 5/8	2 5/16	6	7/8	13/32	9/32	1 1/8	0.444	1.341	63.39	53.74	
68	D60E68	E	16.670	16.240	C4	3 1/2	2 5/8	2 5/16	6	7/8	13/32	9/32	1 1/8	0.444	1.341	54.32	44.32	
76	D60E76	E	18.580	18.149	C4	3 1/2	2 5/8	2 5/16	6	7/8	13/32	9/32	1 1/8	0.444	1.341	61.48	51.48	
95	D60E95	E	23.120	22.683	C4	3 1/2	2 5/8	2 5/16	6	7/8	13/32	9/32	1 1/8	0.444	1.341	82.96	72.96	

★★ Not illustrated. Dimensions listed correspond approximately to illustrations shown.



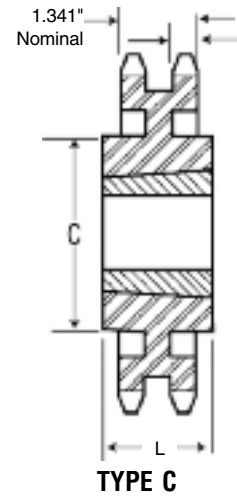
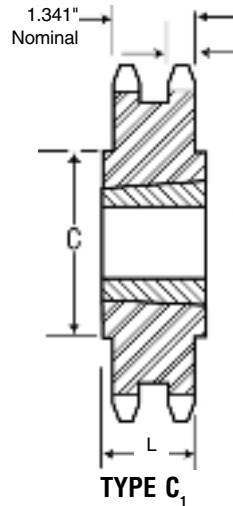
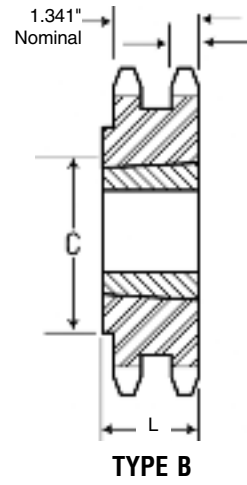
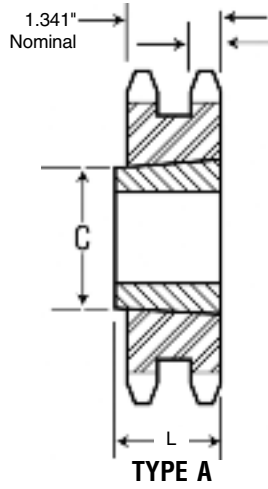

### Double - Taper Bushed

No. Teeth	Catalog Number	Bushing	Diameters		Max. Bore	Dimensions			Weight Lbs. (Approx.)	
			Outside Diameter	Pitch Diameter		L	C	Type	Rim Only	Bushing Only
13	D60BTB13H	1215	3.493	3.134	1 1/4	1 1/2	2 1/4	B	1.2	1.6
14	D60BTB14H	1215	3.736	3.371	1 1/4	1 1/2	2 1/2	B	1.6	1.7
15	D60BTB15H	1615	3.979	3.607	1 1/2	1 1/2	2 5/8	B	1.3	1.8
16	D60BTB16H	1615	4.221	3.844	1 1/2	1 1/2	3	B	2.2	2.3
17	D60BTB17H	1615	4.462	4.082	1 5/8	1 1/2	3 1/4	B	2.5	2.8
18	D60ATB18H	2012	4.704	4.319	2	1 1/4	—	A	3.0	2.4
19	D60ATB19H	2012	4.945	4.557	2	1 1/4	—	A	3.5	2.9
20	D60BTB20H	2517	5.185	4.794	2 1/2	1 1/4	3 5/8	B	4.0	2.9
21	D60BTB21H	2517	5.426	5.032	2 1/2	1 1/4	4 1/8	B	5.0	3.8
25	D60BTB25H	2517	6.387	4.984	2 1/2	1 1/4	5 5/8	B	7.5	7.4
30	D60BTB30	2517	7.586	7.175	2 1/2	1 1/4	6 5/8	B	13.5	13.3
36	D60CTB36	2517	9.022	8.605	2 1/2	1 1/4	4 1/4	C 1	17.5	17.4
42	D60CTB42	2517	10.458	10.036	2 1/2	1 1/4	4 1/4	C 1	25.5	25.0
45	D60CTB45	2517	11.176	10.752	2 1/2	1 1/4	4 1/4	C 1	29.5	29.3
52	D60CTB52	2517	12.849	12.422	2 1/2	1 1/4	4 1/4	C 1	41.0	40.3
60	D60CTB60	2517	14.761	14.330	2 1/2	1 1/4	4 1/4	C	32.5	33.5
68	D60CTB68	2517	16.672	16.240	2 1/2	1 1/4	4 1/2	C	36.5	43.2
76	D60CTB76	3020	18.583	18.149	3	2	5	C	42.5	47.8
95	D60CTB95	3020	23.121	22.684	3	2	5 1/4	C	48.5	69.8

NOTE: Double 60 stock sprockets with 25 teeth or less have hardened teeth.

# No. 60-2

## 3/4" Pitch

# MST® Sprockets

# Martin

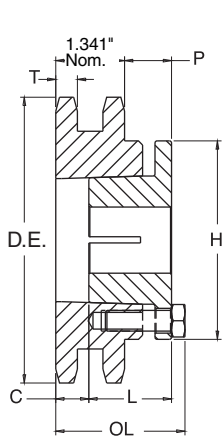

TYPE 11

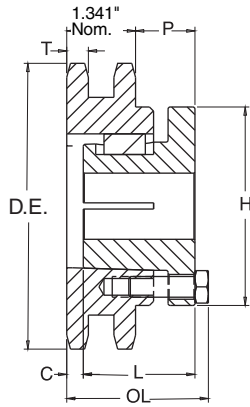

TYPE 12

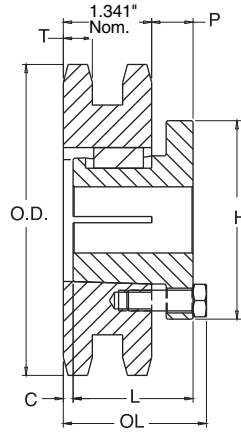

TYPE 13

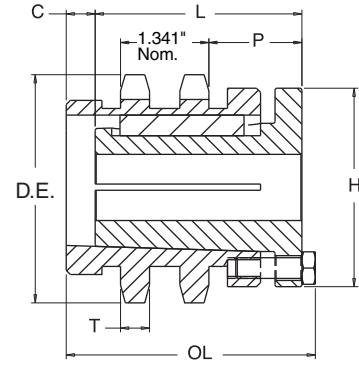

TYPE 16

## Double - MST® Sprockets

No. Teeth	Catalog Number	Bushing	Diameters		Type	Max. Bore	Dimensions						Weight Lbs. (Approx.)	
			Outside Dia.	Pitch Dia.			OL	L	C	H	P	T(nom)	With Hub	Rim Only
13	D60P13H	P1	3.490	3.134	16	1-3/4	3-13/16	1-15/16	1 5/8	3	1-13/32	0.444	3.8	2.5
14	D60P14H	P1	3.740	3.371	12	1-3/4	3	1-15/16	13/16	3	1-13/32	0.444	3.6	2.3
15	D60P15H	P1	3.980	3.607	12	1-3/4	3	1-15/16	13/16	3	1-13/32	0.444	4.0	2.7
16	D60P16H	P1	4.220	3.844	13	1-3/4	2-7/32	1-15/16	1/32	3	5/8	0.444	3.7	2.4
17	D60P17H	P1	4.460	4.082	13	1-3/4	2-7/32	1-15/16	1/32	3	5/8	0.444	4.1	2.8
18	D60P18H	P1	4.700	4.319	13	1-3/4	2-7/32	1-15/16	1/32	3	5/8	0.444	4.7	3.4
19	D60P19H	P1	4.950	4.557	13	1-3/4	2-7/32	1-15/16	1/32	3	5/8	0.444	5.3	4.0
20	D60P20H	P1	5.190	4.794	13	1-3/4	2-7/32	1-15/16	1/32	3	5/8	0.444	6.0	4.7
21	D60Q21H	Q1	5.430	5.032	12	2-11/16	2-25/32	2-1/2	0	4-1/8	1-5/32	0.444	8.3	4.8
22	D60Q22H	Q1	5.670	5.270	12	2-11/16	2-25/32	2-1/2	0	4-1/8	1-5/32	0.444	9.1	5.6
23	D60Q23H	Q1	5.910	5.508	12	2-11/16	2-25/32	2-1/2	0	4-1/8	1-5/32	0.444	9.8	6.3
24	D60Q24H	Q1	6.150	5.746	12	2-11/16	2-25/32	2-1/2	0	4-1/8	1-5/32	0.444	10.5	7.0
25	D60Q25H	Q1	6.390	5.984	12	2-11/16	2-25/32	2-1/2	0	4-1/8	1-5/32	0.444	11.4	7.9
26	D60Q26H	Q1	6.630	6.222	12	2-11/16	2-25/32	2-1/2	0	4-1/8	1-5/32	0.444	12.3	8.8
27	D60Q27H	Q1	6.870	6.460	12	2-11/16	2-25/32	2-1/2	0	4-1/8	1-5/32	0.444	13.1	9.6
28	D60Q28H	Q1	7.110	6.699	12	2-11/16	2-25/32	2-1/2	0	4-1/8	1-5/32	0.444	14.0	10.5
30	D60Q30H	Q1	7.590	7.175	12	2-11/16	2-25/32	2-1/2	0	4-1/8	1-5/32	0.444	15.8	12.3
32	D60Q32H	Q1	8.070	7.652	12	2-11/16	2-25/32	2-1/2	0	4-1/8	1-5/32	0.444	17.8	14.3
35	D60Q35H	Q1	8.780	8.367	12	2-11/16	2-25/32	2-1/2	0	4-1/8	1-5/32	0.444	21.2	17.7
36	D60Q36H	Q1	9.020	8.605	12	2-11/16	2-25/32	2-1/2	0	4-1/8	1-5/32	0.444	21.9	18.4
40	D60Q40H	Q1	9.980	9.559	12	2-11/16	2-25/32	2-1/2	0	4-1/8	1-5/32	0.444	27.4	23.9
42	D60Q42	Q1	10.460	10.036	12	2-11/16	2-25/32	2-1/2	0	4-1/8	1-5/32	0.444	29.8	26.3
42	D60R42	R1	10.460	10.036	12	3-3/4	3-5/32	2-7/8	0	5-3/8	1-17/32	0.444	33.2	25.7
45	D60R45	R1	11.180	10.752	12	3-3/4	3-5/32	2-7/8	0	5-3/8	1-17/32	0.444	37.7	30.2
48	D60R48	R1	11.890	11.467	12	3-3/4	3-5/32	2-7/8	0	5-3/8	1-17/32	0.444	42.6	35.1
52	D60R52	R1	12.850	12.422	12	3-3/4	3-5/32	2-7/8	0	5-3/8	1-17/32	0.444	49.3	41.8
54	D60R54	R1	13.330	12.899	12	3-3/4	3-5/32	2-7/8	0	5-3/8	1-17/32	0.444	52.6	45.1
60	D60R60	R1	14.760	14.331	12	3-3/4	3-5/32	2-7/8	0	5-3/8	1-17/32	0.444	62.3	54.8
68	D60R68	R1	16.670	16.240	12	3-3/4	3-5/32	2-7/8	0	5-3/8	1-17/32	0.444	81.3	73.8
72	D60R72	R1	17.630	17.194	12	3-3/4	3-5/32	2-7/8	0	5-3/8	1-17/32	0.444	89.3	81.8
76	D60R76	R1	18.580	18.149	12	3-3/4	3-5/32	2-7/8	0	5-3/8	1-17/32	0.444	100.5	93.0
84	D60R84	R1	20.490	20.058	12	3-3/4	3-5/32	2-7/8	0	5-3/8	1-17/32	0.444	118.5	111.0
95	D60R95	R1	23.120	22.683	12	3-3/4	3-5/32	2-7/8	0	5-3/8	1-17/32	0.444	155.5	148.0
96	D60R96	R1	23.360	22.922	12	3-3/4	3-5/32	2-7/8	0	5-3/8	1-17/32	0.444	162.5	155.0

Sprockets with "H" suffix have hardened teeth.

### Triple - Type B & C

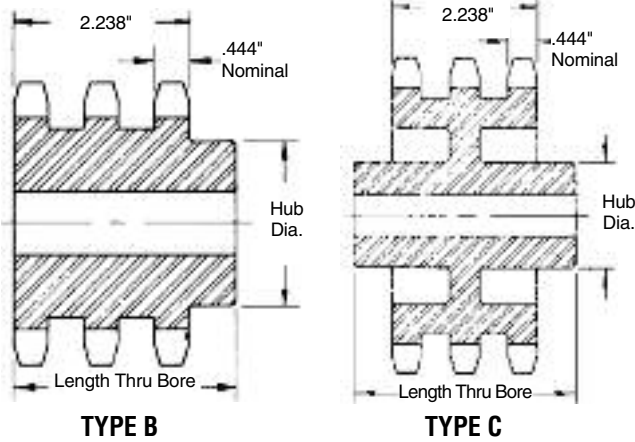

No. Teeth	Catalog Number	Outside Diameter	Type	Bore (inches)		Hub (inches)		Weight Lbs. (Approx.)
				Stock	Rec. Max.	Dia.	Length Thru	
11	E60B11H	3.000	B	1	1 1/4	1 1/16	3	2.5
12	E60B12H	3.250	B	1	1 1/8	2 1/8	3	3.3
13	E60B13H	3.490	B	1	1 1/2	2 1/2	3	3.9
14	E60B14H	3.740	B	1	1 3/4	2 3/4	3	4.5
15	E60B15H	3.980	B	1	1 7/8	2 7/8	3	5.4
16	E60B16H	4.220	B	1	2	3	3	6.5
17	E60B17H	4.460	B	1	2 1/8	3 1/8	3	7.7
18	E60B18H	4.700	B	1	2 1/4	3 1/4	3	8.5
19	E60B19H	4.950	B	1	2 1/2	3 1/2	3	10.0
20	E60B20H	5.190	B	1	2 3/4	3 3/4	3	11.2
21	E60B21H	5.430	B	1	2 7/8	4	3	12.5
22	E60B22H	5.670	B	1	3	4 1/8	3	13.2
23	E60B23H	5.910	B	1	3 1/8	4 1/8	3	14.6
24	E60B24H	6.150	B	1	3 1/4	4 1/4	3	15.8
25	E60B25H	6.390	B	1	3 3/8	4 3/8	3	17.0
26	E60B26	6.630	B	1	3 1/2	4 1/2	3	18.6
30	E60B30	7.590	B	1	3 3/4	4 3/4	3	23.2
35	E60B35	8.780	B	1 1/4	4	5 1/8	3 1/2	34.5
36	E60B36	9.020	B	1 1/2	4 1/4	5 1/4	3 3/4	37.0
42	E60B42	10.460	B	1 3/4	4 3/4	5 3/4	3 3/4	49.0
45	E60B45	11.180	B	1 3/4	5	6	3 3/4	57.0
52	E60C52	12.850	C	1 3/4	5 1/4	6 1/4	3 3/4	73.0
60	E60C60	14.760	C	1 3/4	5 3/4	6 3/4	3 1/2	63.0
68	E60C68	16.670	C	1 3/4	6	7	3 1/2	73.0
72	E60C72	17.630	C	1 3/4	6 1/4	7 1/4	3 1/2	85.0
76	E60C76	18.580	C	1 3/4	6 3/4	7 3/4	3 1/2	82.0
95	E60C95	23.120	C	1 3/4	7 3/4	8 3/4	4	105.0

Maximum bores shown will accommodate standard keyseat and setscrew over keyseat. Slightly larger bores are possible with no keyseat, shallow over keyseat, or setscrew at angle to keyseat.

NOTE: Triple 60 stock sprockets with 25 teeth or less have hardened teeth. As indicated by H suffix.



#### Alteration Charges

See current discount sheet for alteration charges.



QD — TYPE B

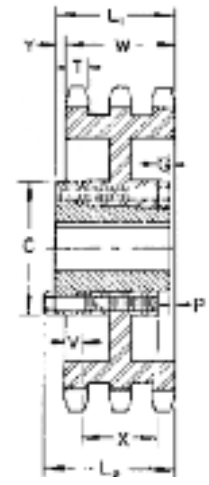

QD — TYPE B1

### Triple - Type QD

No. Teeth	Catalog Number	Bush-ing	Diameters		Type	Max. Bore	Dimensions										Weight Lbs. (Approx.)	
			Outside Diameter	Pitch Diameter			L <sub>1</sub>	L <sub>2</sub>	C	Y	P	G	V	X	T	W	With Hub	Rim Only
36	E60E36	E	9.020	8.605	B	3 1/2	2 1/2	2 1/16	6	1 3/4	1/8	—	—	1 1/8	0.444	2.238	49.0	37.0
42	E60E42	E	10.460	10.036	B	3 3/4	2 5/8	2 1/8	6	1 3/4	1/8	—	—	1 1/8	0.444	2.238	62.0	50.0
52	E60E52	E	12.850	12.422	B	3 1/2	2 5/8	2 1/8	6	1 3/4	1/8	—	—	1 1/8	0.444	2.238	80.0	68.0
68	E60E68	E	16.670	16.240	B1	3 1/2	2 3/8	3 3/4	6	1 1/2	3/16	1/8	3/16	1 1/8	0.444	2.238	83.0	71.0
76	E60E76	E	18.580	18.149	B1	3 1/2	2 3/8	3 3/4	6	1 1/2	3/16	1/8	3/16	1 1/8	0.444	2.238	99.0	87.0
95	E60E95	E	23.120	22.683	B1	3 1/2	2 3/8	3 3/4	6	1 1/2	3/16	1/8	3/16	1 1/8	0.444	2.238	129.0	117.0

# No. 60-3

## 3/4" Pitch

# MST® Sprockets

# Martin

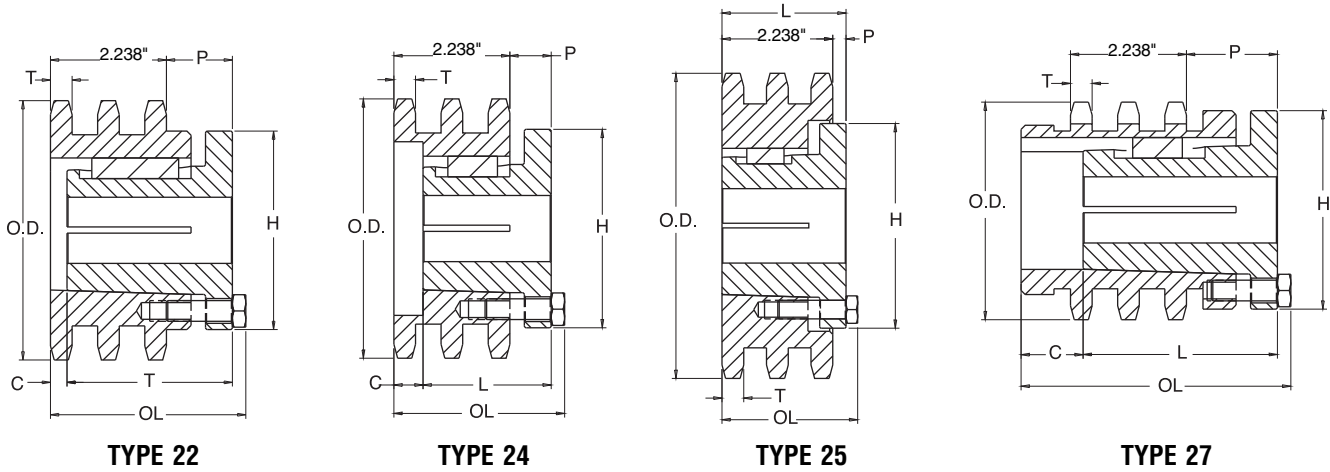

## Triple - MST® Sprockets

No. Teeth	Catalog Number	Bush-ing	Diameters		Type	Max. Bore	Dimensions						Weight Lbs. (Approx.)	
			Outside Dia.	Pitch Dia.			OL	L	C	H	P	T(nom)	With Hub	Rim Only
13	E60P13H	P2	3.490	3.134	27	1-3/4	4-23/32	2-15/16	1 17/32	3	1-13/32	0.444	4.8	3.3
14	E60P14H	P2	3.740	3.371	22	1-3/4	3-29/32	2-15/16	1-23/32	3	1-13/32	0.444	4.8	3.3
15	E60P15H	P2	3.980	3.607	22	1-3/4	3-29/32	2-15/16	1-23/32	3	1-13/32	0.444	5.5	4.0
16	E60P16H	P1	4.220	3.844	24	1-3/4	3 1/8	1-15/16	15/16	3	5/8	0.444	4.7	3.4
17	E60Q17H	Q1	4.460	4.082	27	2-11/16	5	3-1/2	13/32	4-1/8	1-21/32	0.444	8.1	4.6
18	E60Q18H	Q1	4.700	4.319	22	2-11/16	4-3/16	3-1/2	13/32	4-1/8	1-21/32	0.444	8.5	5.0
19	E60Q19H	Q1	4.950	4.557	22	2-11/16	4-3/16	3-1/2	13/32	4-1/8	1-21/32	0.444	9.4	5.9
20	E60Q20H	Q1	5.190	4.794	22	2-11/16	4-3/16	3-1/2	13/32	4-1/8	1-21/32	0.444	10.5	6.2
21	E60Q21H	Q1	5.430	5.032	24	2-11/16	3-1/4	2-1/2	15/32	4-1/8	3/4	0.444	9.2	6.4
22	E60Q22H	Q1	5.670	5.270	24	2-11/16	3-1/4	2-1/2	15/32	4-1/8	3/4	0.444	10.1	6.6
23	E60Q23H	Q1	5.910	5.508	25	2-11/16	2-25/32	2-1/2	0	4-1/8	1/4	0.444	11.2	7.7
24	E60Q24H	Q1	6.150	5.746	25	2-11/16	2-25/32	2-1/2	0	4-1/8	1/4	0.444	12.3	8.8
25	E60Q25H	Q1	6.390	5.984	25	2-11/16	2-25/32	2-1/2	0	4-1/8	1/4	0.444	13.5	10.0
26	E60Q26H	Q1	6.630	6.222	25	2-11/16	2-25/32	2-1/2	0	4-1/8	1/4	0.444	14.6	11.1
27	E60Q27H	Q1	6.870	6.460	25	2-11/16	2-25/32	2-1/2	0	4-1/8	1/4	0.444	15.9	12.4
28	E60Q28H	Q1	7.110	6.699	25	2-11/16	2-25/32	2-1/2	0	4-1/8	1/4	0.444	17.1	13.6
30	E60R30H	R1	7.590	7.175	25	3-3/4	3-5/32	2-7/8	0	5-3/8	5/8	0.444	21.5	14.0
32	E60R32H	R1	8.070	7.652	25	3-3/4	3-5/32	2-7/8	0	5-3/8	5/8	0.444	26.5	19.0
35	E60R35H	R1	8.780	8.367	25	3-3/4	3-5/32	2-7/8	0	5-3/8	5/8	0.444	29.5	22.0
36	E60R36H	R1	9.020	8.605	25	3-3/4	3-5/32	2-7/8	0	5-3/8	5/8	0.444	30.9	23.4
40	E60R40	R1	9.980	9.559	25	3-3/4	3-5/32	2-7/8	0	5-3/8	5/8	0.444	38.8	31.3
42	E60R42	R1	10.460	10.036	25	3-3/4	3-5/32	2-7/8	0	5-3/8	5/8	0.444	42.8	35.3
52	E60R52	R1	12.850	12.422	25	3-3/4	3-5/32	2-7/8	0	5-3/8	5/8	0.444	70.7	63.2

Sprockets with "H" suffix have hardened teeth.

### Single Type BS — 2 Setscrews — Bored-To-Size

No. Teeth	Catalog Number	Outside Diameter	Length Thru Bore	Weight Lbs. (Approx.)	Stock Finished Bores Includes Keyway and Setscrews																		
9	80BS9	3.350	1 $\frac{1}{8}$	1.6	1	—	1 $\frac{1}{8}$	—	1 $\frac{1}{8}$	—	1 $\frac{1}{8}$	—	1 $\frac{1}{8}$	—	1 $\frac{1}{8}$	—	1 $\frac{1}{8}$	—	1 $\frac{1}{8}$	—	1 $\frac{1}{8}$	—	1 $\frac{1}{8}$
10	80BS10	3.680	1 $\frac{1}{8}$	1.7	1	—	1 $\frac{1}{8}$	—	1 $\frac{1}{8}$	—	1 $\frac{1}{8}$	—	1 $\frac{1}{8}$	—	1 $\frac{1}{8}$	—	1 $\frac{1}{8}$	—	1 $\frac{1}{8}$	—	1 $\frac{1}{8}$	—	1 $\frac{1}{8}$
10	80BS10W★	3.680	1 $\frac{1}{8}$	1.7																			
11	80BS11	4.010	1 $\frac{1}{8}$	1.8	1	—	1 $\frac{1}{8}$	—	1 $\frac{1}{8}$	—	1 $\frac{1}{8}$	—	1 $\frac{1}{8}$	—	1 $\frac{1}{8}$	—	1 $\frac{1}{8}$	—	1 $\frac{1}{8}$	—	1 $\frac{1}{8}$	—	1 $\frac{1}{8}$
11	80BS11W★	4.010	1 $\frac{1}{8}$	1.8																			
12	80BS12	4.330	1 $\frac{1}{8}$	3.0	1	—	1 $\frac{1}{8}$	—	1 $\frac{1}{8}$	—	1 $\frac{1}{8}$	—	1 $\frac{1}{8}$	—	1 $\frac{1}{8}$	—	1 $\frac{1}{8}$	—	1 $\frac{1}{8}$	—	1 $\frac{1}{8}$	—	1 $\frac{1}{8}$
12	80BS12W★	4.330	1 $\frac{1}{8}$	3.0																			
13	80BS13	4.660	1 $\frac{1}{8}$	3.5	1	—	1 $\frac{1}{8}$	—	1 $\frac{1}{8}$	—	1 $\frac{1}{8}$	—	1 $\frac{1}{8}$	—	1 $\frac{1}{8}$	—	1 $\frac{1}{8}$	—	1 $\frac{1}{8}$	—	1 $\frac{1}{8}$	—	1 $\frac{1}{8}$
14	80BS14	4.980	1 $\frac{1}{8}$	4.1	1	—	1 $\frac{1}{8}$	—	1 $\frac{1}{8}$	—	1 $\frac{1}{8}$	—	1 $\frac{1}{8}$	—	1 $\frac{1}{8}$	—	1 $\frac{1}{8}$	—	1 $\frac{1}{8}$	—	1 $\frac{1}{8}$	—	1 $\frac{1}{8}$
15	80BS15	5.300	1 $\frac{1}{8}$	5.2	1	—	1 $\frac{1}{8}$	—	1 $\frac{1}{8}$	—	1 $\frac{1}{8}$	—	1 $\frac{1}{8}$	—	1 $\frac{1}{8}$	—	1 $\frac{1}{8}$	—	1 $\frac{1}{8}$	—	1 $\frac{1}{8}$	—	1 $\frac{1}{8}$
15	80BS15W★	5.300	1 $\frac{1}{8}$	5.3																			
16	80BS16	5.630	1 $\frac{1}{8}$	5.5	1	—	—	1 $\frac{1}{8}$	—	1 $\frac{1}{8}$	—	1 $\frac{1}{8}$	—	1 $\frac{1}{8}$	—	1 $\frac{1}{8}$	—	1 $\frac{1}{8}$	—	1 $\frac{1}{8}$	—	1 $\frac{1}{8}$	—
17	80BS17	5.950	1 $\frac{1}{8}$	6.0	1	—	—	1 $\frac{1}{8}$	—	1 $\frac{1}{8}$	—	1 $\frac{1}{8}$	—	1 $\frac{1}{8}$	—	1 $\frac{1}{8}$	—	1 $\frac{1}{8}$	—	1 $\frac{1}{8}$	—	1 $\frac{1}{8}$	—
18	80BS18	6.270	1 $\frac{1}{8}$	6.5	1	—	—	1 $\frac{1}{8}$	—	1 $\frac{1}{8}$	—	1 $\frac{1}{8}$	—	1 $\frac{1}{8}$	—	1 $\frac{1}{8}$	—	1 $\frac{1}{8}$	—	1 $\frac{1}{8}$	—	1 $\frac{1}{8}$	—
18	80BS18W★	6.270	1 $\frac{1}{8}$	6.0																			
19	80BS19	6.590	1 $\frac{1}{8}$	7.0	1	—	—	1 $\frac{1}{8}$	—	1 $\frac{1}{8}$	—	1 $\frac{1}{8}$	—	1 $\frac{1}{8}$	—	1 $\frac{1}{8}$	—	1 $\frac{1}{8}$	—	1 $\frac{1}{8}$	—	1 $\frac{1}{8}$	—
20	80BS20	6.910	1 $\frac{1}{8}$	8.0	1	—	—	1 $\frac{1}{8}$	—	1 $\frac{1}{8}$	—	1 $\frac{1}{8}$	—	1 $\frac{1}{8}$	—	1 $\frac{1}{8}$	—	1 $\frac{1}{8}$	—	1 $\frac{1}{8}$	—	1 $\frac{1}{8}$	—
21	80BS21	7.240	1 $\frac{1}{8}$	8.9	1	—	—	1 $\frac{1}{8}$	—	1 $\frac{1}{8}$	—	1 $\frac{1}{8}$	—	1 $\frac{1}{8}$	—	1 $\frac{1}{8}$	—	1 $\frac{1}{8}$	—	1 $\frac{1}{8}$	—	1 $\frac{1}{8}$	—
22	80BS22	7.560	1 $\frac{1}{8}$	9.5	1	—	—	1 $\frac{1}{8}$	—	1 $\frac{1}{8}$	—	1 $\frac{1}{8}$	—	1 $\frac{1}{8}$	—	1 $\frac{1}{8}$	—	1 $\frac{1}{8}$	—	1 $\frac{1}{8}$	—	1 $\frac{1}{8}$	—
23	80BS23	7.880	1 $\frac{1}{8}$	10.2	1	—	—	1 $\frac{1}{8}$	—	1 $\frac{1}{8}$	—	1 $\frac{1}{8}$	—	1 $\frac{1}{8}$	—	1 $\frac{1}{8}$	—	1 $\frac{1}{8}$	—	1 $\frac{1}{8}$	—	1 $\frac{1}{8}$	—
24	80BS24	8.200	1 $\frac{1}{8}$	10.8	1	—	—	1 $\frac{1}{8}$	—	1 $\frac{1}{8}$	—	1 $\frac{1}{8}$	—	1 $\frac{1}{8}$	—	1 $\frac{1}{8}$	—	1 $\frac{1}{8}$	—	1 $\frac{1}{8}$	—	1 $\frac{1}{8}$	—
25	80BS25	8.520	1 $\frac{1}{8}$	11.4	1	—	—	1 $\frac{1}{8}$	—	1 $\frac{1}{8}$	—	1 $\frac{1}{8}$	—	1 $\frac{1}{8}$	—	1 $\frac{1}{8}$	—	1 $\frac{1}{8}$	—	1 $\frac{1}{8}$	—	1 $\frac{1}{8}$	—
26	80BS26	8.840	2	14.0																			
27	80BS27	9.160	2	14.7																			
28	80BS28	9.480	2	15.3																			
29	80BS29	9.800	2	16.4																			
30	80BS30	10.110	2	16.7																			
31	80BS31	10.430	2	18.0																			
32	80BS32	10.750	2	18.8																			
33	80BS33	11.070	2	18.9																			
34	80BS34	11.390	2	20.6																			
35	80BS35	11.710	2	21.4																			
36	80BS36	12.030	2	22.4																			
37	80BS37	12.350	2	23.9																			
38	80BS38	12.670	2	24.0																			
39	80BS39	12.990	2	24.9																			
40	80BS40	13.310	2	26.0																			
41	80BS41	13.630	2	27.1																			
42	80BS42	13.940	2	28.0																			
43	80BS43	14.260	2	29.3																			
44	80BS44	14.580	2	29.3																			
45	80BS45	14.900	2	30.7																			
46	80BS46	15.220	2	32.4																			
47	80BS47	15.540	2	33.3																			
48	80BS48	15.860	2	34.8																			
49	80BS49	16.180	2	35.1																			
50	80BS50	16.500	2	36.6																			
51	80BS51	16.810	2	38.5																			
52	80BS52	17.130	2	40.3																			
53	80BS53	17.450	2	42.2																			
54	80BS54	17.770	2	44.0																			
55	80BS55	18.090	2	46.3																			
56	80BS56	18.410	2	47.3																			
57	80BS57	18.730	2	48.9																			
58	80BS58	19.040	2	50.6																			
59	80BS59	19.360	2	52.2																			
60	80BS60	19.680	2	58.8																			

Hub diameters vary to suit different bore sizes.

★ W = Winch Sprockets — KW  $\frac{3}{16}$  ×  $\frac{3}{32}$  — One S.S. at 90°

NOTE: KEYWAY IS ON CENTER LINE OF TOOTH

# No. 80 1" Pitch

# All Steel Stock Sprockets

# Martin

## Single Type BS Winch — 1 Setscrew

No. Teeth	Catalog Number	Outside Diameter	Length Thru Bore	Weight Lbs. (Approx.)	Stock Finished Bores Includes Keyway (see Footnote) and Set Screw at 90° from Keyway
10	80BS10W	3.680	1"	1.7	1"
11	80BS11W	4.010	1"	1.8	1"
12	80BS12W	4.330	1"	3.0	1"
15	80BS15W	5.300	1"	5.2	1"
18	80BS18W	6.270	1"	7.8	1" — 1 1/2"

NOTE: KEYWAY IS ON CENTER LINE OF TOOTH.

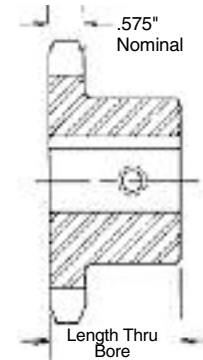

SINGLE TYPE BS

## Double Type BS Winch (Hardened Teeth) — 1 Setscrew

No. Teeth	Catalog Number	Outside Diameter	Length Thru Bore	Weight Lbs. (Approx.)	Stock Finished Bores Includes Keyway (see Footnote) and Set Screw at 90° from Keyway
12	D80BS12HW	3.680	2"	5.2	1 1/4" — 1 1/2" — 1 3/4"
15	D80BS15HW	5.300	2"	9.2	1 1/4" — 1 1/2" — 1 3/4"
18	D80BS18HW	6.270	2"	13.5	1 1/2" — 1 3/4" — 2"
20	D80BS20HW	6.910	2"	16.2	1 1/2" — 1 3/4" — 2"
24	D80BS24HW	8.200	2"	23.2	1 1/2" — 2"

NOTE: KEYWAY IS ON CENTER LINE OF TOOTH.

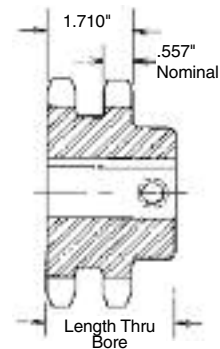

DOUBLE TYPE BS

Footnote: 1/4" bore has a 5/16" x 3/32" keyway  
 1/2" bore has a 5/16" x 3/32" keyway  
 3/4" bore has a 3/8" x 3/16" keyway  
 2" bore has a 3/8" x 3/16" keyway



## No. 80 — Hardened Teeth — 2 Setscrews

No. Teeth	Catalog Number	Outside Diameter	Length Thru Bore	Weight Lbs. (Approx.)	Stock Finished Bores Includes Keyway and 2 Setscrews
9	80BS9HT	3.350	1"	1.6	1 — 1 1/8" — 1 1/4" — 1 1/2"
10	80BS10HT	3.368	1"	1.7	1 — 1 1/8" — 1 1/4" — 1 1/2"
11	80BS11HT	4.010	1"	1.8	1 — 1 1/8" — 1 1/4" — 1 1/2" — 1 3/4" — 1 1/2" — 1 3/4"
12	80BS12HT	4.330	1"	3.0	1 — 1 1/8" — 1 1/4" — 1 1/2" — 1 3/4" — 1 1/2" — 1 3/4" — 1 1/2" — 1 3/4"
13	80BS13HT	4.660	1"	3.5	1 — 1 1/8" — 1 1/4" — 1 1/2" — 1 3/4" — 1 1/2" — 1 3/4" — 1 1/2" — 1 3/4" — 1 1/2" — 1 3/4"
14	80BS14HT	4.980	1 1/2"	4.1	1 — 1 1/8" — 1 1/4" — 1 1/2" — 1 3/4" — 1 1/2" — 1 3/4" — 1 1/2" — 1 3/4" — 1 1/2" — 1 3/4" — 1 1/2" — 1 3/4"
15	80BS15HT	5.300	1 1/2"	5.2	1 — 1 1/8" — 1 1/4" — 1 1/2" — 1 3/4" — 1 1/2" — 1 3/4" — 1 1/2" — 1 3/4" — 1 1/2" — 1 3/4" — 1 1/2" — 1 3/4"
16	80BS16HT	5.630	1 1/2"	6.1	1 — 1 1/8" — 1 1/4" — 1 1/2" — 1 3/4" — 1 1/2" — 1 3/4" — 1 1/2" — 1 3/4" — 1 1/2" — 1 3/4" — 1 1/2" — 1 3/4"
17	80BS17HT	5.950	1 1/2"	7.0	1 — 1 1/8" — 1 1/4" — 1 1/2" — 1 3/4" — 1 1/2" — 1 3/4" — 1 1/2" — 1 3/4" — 1 1/2" — 1 3/4" — 1 1/2" — 1 3/4"
18	80BS18HT	6.270	1 1/2"	7.8	1 — 1 1/8" — 1 1/4" — 1 1/2" — 1 3/4" — 1 1/2" — 1 3/4" — 1 1/2" — 1 3/4" — 1 1/2" — 1 3/4" — 1 1/2" — 1 3/4"
19	80BS19HT	6.590	1 1/2"	8.3	1 — 1 1/8" — 1 1/4" — 1 1/2" — 1 3/4" — 1 1/2" — 1 3/4" — 1 1/2" — 1 3/4" — 1 1/2" — 1 3/4" — 1 1/2" — 1 3/4"
20	80BS20HT	6.910	1 1/2"	9.5	1 — 1 1/8" — 1 1/4" — 1 1/2" — 1 3/4" — 1 1/2" — 1 3/4" — 1 1/2" — 1 3/4" — 1 1/2" — 1 3/4" — 1 1/2" — 1 3/4"

NOTE: KEYWAY IS ON CENTER LINE OF TOOTH

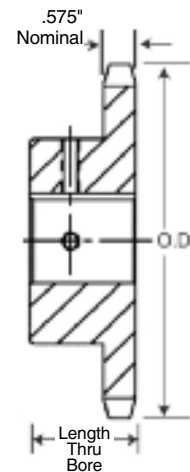

TYPE BS

*Martin* stock hardened teeth sprockets afford longer chain and sprocket life. Hardened teeth on the smaller sprocket of a roller chain drive are recommended if the drive ratio is four to one or greater or if the smaller sprocket has 24 teeth or less and is running at a speed of over 600 R.P.M.

## Single - Type C — Steel

No. Teeth	Catalog Number	Outside Diameter	Bore (inches)		Hub (inches)		Weight Lbs. (Approx.)
			Stock	Rec. Max.	Diameter	Length	
11	80C11	4.010	1	1 1/8"	2 3/32" ★	2"	3.87
12	80C12	4.330	1	1 1/8"	3" ★	2"	4.31
13	80C13	4.660	1	2"	3 3/4"	2"	5.32
14	80C14	4.980	1	2 1/4"	3 1/2"	2"	6.44
15	80C15	5.300	1	2 1/2"	3 1/4"	2"	7.75
16	80C16	5.630	1	2 3/4"	4"	2"	8.81

★ Has recessed groove in hub for chain clearance.

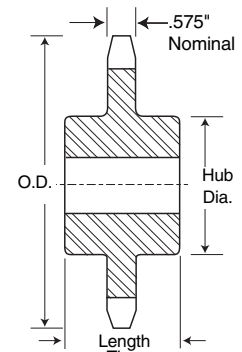

TYPE C



### Double Single - Type A — Steel

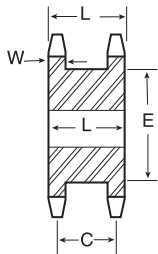

TYPE A

No. Teeth	Catalog Number	Diameters		Type	Min. Bore	Max. Bore	Dimensions				Wt. (Approx.)
		Outside Diameter	Pitch Diameter				L	C	E	w Nom.	
13	DS80A13	4.660	4.179	A	1	2	2 <sup>3</sup> / <sub>16</sub>	1 <sup>5</sup> / <sub>8</sub>	3 <sup>3</sup> / <sub>16</sub>	0.575	6.5
14	DS80A14	4.980	4.494	A	1	2 <sup>1</sup> / <sub>4</sub>	2 <sup>3</sup> / <sub>16</sub>	1 <sup>5</sup> / <sub>8</sub>	3 <sup>1</sup> / <sub>2</sub>	0.575	7.7
15	DS80A15	5.300	4.810	A	1	2 <sup>3</sup> / <sub>8</sub>	2 <sup>3</sup> / <sub>16</sub>	1 <sup>5</sup> / <sub>8</sub>	3 <sup>3</sup> / <sub>16</sub>	0.575	9.1
16	DS80A16	5.630	5.126	A	1	2 <sup>1</sup> / <sub>2</sub>	2 <sup>3</sup> / <sub>16</sub>	1 <sup>5</sup> / <sub>8</sub>	4	0.575	9.5
17	DS80A17	5.950	5.442	A	1	2 <sup>3</sup> / <sub>8</sub>	2 <sup>3</sup> / <sub>16</sub>	1 <sup>5</sup> / <sub>8</sub>	4 <sup>1</sup> / <sub>16</sub>	0.575	10.8
18	DS80A18	6.270	5.759	A	1	3 <sup>1</sup> / <sub>8</sub>	2 <sup>3</sup> / <sub>16</sub>	1 <sup>5</sup> / <sub>8</sub>	4 <sup>1</sup> / <sub>16</sub>	0.575	12.1
19	DS80A19	6.590	6.076	A	1	3 <sup>1</sup> / <sub>4</sub>	2 <sup>3</sup> / <sub>16</sub>	1 <sup>5</sup> / <sub>8</sub>	4 <sup>3</sup> / <sub>16</sub>	0.575	12.8
20	DS80A20	6.910	6.392	A	1	3 <sup>1</sup> / <sub>2</sub>	2 <sup>3</sup> / <sub>16</sub>	1 <sup>5</sup> / <sub>8</sub>	5 <sup>1</sup> / <sub>16</sub>	0.575	14.0
21	DS80A21	7.240	6.710	A	1	3 <sup>3</sup> / <sub>8</sub>	2 <sup>3</sup> / <sub>16</sub>	1 <sup>5</sup> / <sub>8</sub>	5 <sup>1</sup> / <sub>16</sub>	0.575	16.5
22	DS80A22	7.560	7.027	A	1	3 <sup>1</sup> / <sub>2</sub>	2 <sup>3</sup> / <sub>16</sub>	1 <sup>5</sup> / <sub>8</sub>	5 <sup>3</sup> / <sub>16</sub>	0.575	18.4
23	DS80A23	7.880	7.344	A	1	3 <sup>1</sup> / <sub>2</sub>	2 <sup>3</sup> / <sub>16</sub>	1 <sup>5</sup> / <sub>8</sub>	6 <sup>1</sup> / <sub>16</sub>	0.575	20.5

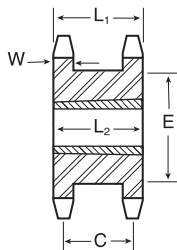

TAPER BUSH  
TYPE A

### Double Single - Taper Bushed — Steel

No. Teeth	Catalog Number	Bushing Size	Diameters		Min. Bore	Max. Bore	Type	Dimensions				Wt. Rim Only	
			Outside Diameter	Pitch Diameter				L <sub>1</sub>	C	E	L <sub>2</sub>		w Nom.
17	DS80ATB17H	2517	5.950	5.442	1/2	2 1/2	A	2 <sup>3</sup> / <sub>16</sub>	1 <sup>5</sup> / <sub>8</sub>	4 <sup>1</sup> / <sub>16</sub>	1 <sup>3</sup> / <sub>8</sub>	0.575	7.6
18	DS80ATB18H	2517	6.270	5.759	1/2	2 1/2	A	2 <sup>3</sup> / <sub>16</sub>	1 <sup>5</sup> / <sub>8</sub>	4 <sup>1</sup> / <sub>16</sub>	1 <sup>3</sup> / <sub>8</sub>	0.575	8.7
19	DS80ATB19H	3020	6.590	6.076	1/16	3	A	2 <sup>3</sup> / <sub>16</sub>	1 <sup>5</sup> / <sub>8</sub>	4 <sup>3</sup> / <sub>16</sub>	2	0.575	9.7
20	DS80ATB20H	3020	6.910	6.392	1/16	3	A	2 <sup>3</sup> / <sub>16</sub>	1 <sup>5</sup> / <sub>8</sub>	5 <sup>1</sup> / <sub>16</sub>	2	0.575	10.0
21	DS80ATB21H	3020	7.240	6.710	1/16	3	A	2 <sup>3</sup> / <sub>16</sub>	1 <sup>5</sup> / <sub>8</sub>	5 <sup>3</sup> / <sub>16</sub>	2	0.575	12.0
22	DS80ATB22H	3020	7.560	7.027	1/16	3	A	2 <sup>3</sup> / <sub>16</sub>	1 <sup>5</sup> / <sub>8</sub>	5 <sup>9</sup> / <sub>16</sub>	2	0.575	13.0
23	DS80ATB23H	3020	7.880	7.344	1/16	3	A	2 <sup>3</sup> / <sub>16</sub>	1 <sup>5</sup> / <sub>8</sub>	6 <sup>1</sup> / <sub>16</sub>	2	0.575	14.5

Sprockets with "H" suffix have hardened teeth.

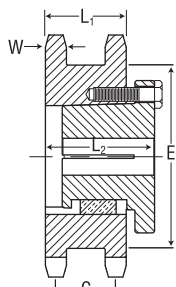

MST  
TYPE B

### Double Single - MST® — Steel

No. Teeth	Catalog Number	Bushing Size	Diameters		Min. Bore	Max. Bore	Type	Dimensions				Wt. Rim Only	
			Outside Diameter	Pitch Diameter				L <sub>1</sub>	C	E	L <sub>2</sub>		w Nom.
17	DS80Q17H	Q1	5.950	5.442	3/4	2 1/16	B	2 <sup>3</sup> / <sub>16</sub>	1 <sup>5</sup> / <sub>8</sub>	4 <sup>3</sup> / <sub>16</sub>	3 <sup>1</sup> / <sub>16</sub>	0.575	7.2
19	DS80Q19H	Q1	6.590	6.076	3/4	2 1/16	B	2 <sup>3</sup> / <sub>16</sub>	1 <sup>5</sup> / <sub>8</sub>	4 <sup>3</sup> / <sub>16</sub>	3 <sup>1</sup> / <sub>16</sub>	0.575	10.5
20	DS80Q20H	Q1	6.910	6.392	3/4	2 1/16	B	2 <sup>3</sup> / <sub>16</sub>	1 <sup>5</sup> / <sub>8</sub>	5 <sup>1</sup> / <sub>16</sub>	3 <sup>1</sup> / <sub>16</sub>	0.575	12.2
21	DS80R21H	R1	7.240	6.710	1 <sup>1</sup> / <sub>8</sub>	3 <sup>3</sup> / <sub>8</sub>	B	2 <sup>3</sup> / <sub>16</sub>	1 <sup>5</sup> / <sub>8</sub>	5 <sup>3</sup> / <sub>16</sub>	3 <sup>23</sup> / <sub>64</sub>	0.575	12.8
23	DS80R23H	R1	7.880	7.344	1 <sup>1</sup> / <sub>8</sub>	3 <sup>3</sup> / <sub>8</sub>	B	2 <sup>3</sup> / <sub>16</sub>	1 <sup>5</sup> / <sub>8</sub>	6 <sup>1</sup> / <sub>16</sub>	3 <sup>23</sup> / <sub>64</sub>	0.575	13.3

Sprockets with "H" suffix have hardened teeth.

# No. 80 1" Pitch

# Stainless Steel Stock Sprockets

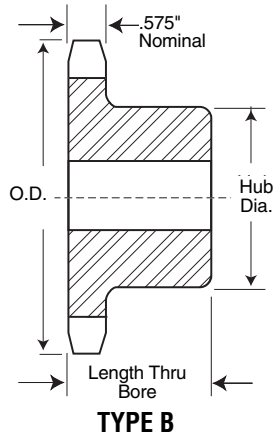
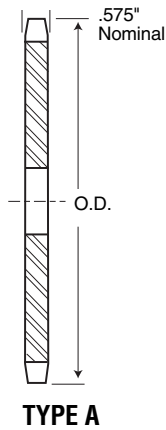

## Single - Type B

## Single - Type A

No. Teeth	Catalog Number	Outside Diameter	Type	Bore (inches)		Hub (inches)		Weight Lbs (Approx.)	Type	Catalog Number	Stock Bore	Weight Lbs. (Approx.)
				Stock	Rec. Max.	Dia.	Length Thru					
10	80B10SS	3.680	B	1	1½	2 <sup>5</sup> / <sub>16</sub> ★	1 <sup>5</sup> / <sub>8</sub>	2.14	—	—	—	—
11	80B11SS	4.010	B	1	1 <sup>5</sup> / <sub>8</sub>	2 <sup>3</sup> / <sub>16</sub> ★	1 <sup>5</sup> / <sub>8</sub>	2.72	—	—	—	—
12	80B12SS	4.330	B	1	1 <sup>5</sup> / <sub>8</sub>	3 <sup>1</sup> / <sub>8</sub> ★	1 <sup>5</sup> / <sub>8</sub>	3.42	A	80A12SS	1 <sup>5</sup> / <sub>16</sub>	1.50
13	80B13SS	4.660	B	1	2	3	1½	3.53	A	80A13SS	1 <sup>5</sup> / <sub>16</sub>	1.80
14	80B14SS	4.980	B	1	2 <sup>1</sup> / <sub>8</sub>	3 <sup>3</sup> / <sub>8</sub>	1½	4.19	A	80A14SS	1 <sup>5</sup> / <sub>16</sub>	2.20
15	80B15SS	5.300	B	1	2 <sup>1</sup> / <sub>8</sub>	3 <sup>13</sup> / <sub>16</sub>	1½	5.38	A	80A15SS	1 <sup>5</sup> / <sub>16</sub>	2.50
16	80B16SS	5.630	B	1	2 <sup>3</sup> / <sub>8</sub>	4	1½	6.07	A	80A16SS	1 <sup>5</sup> / <sub>16</sub>	2.90
17	80B17SS	5.950	B	1	2 <sup>3</sup> / <sub>8</sub>	4	1½	6.45	A	80A17SS	1 <sup>5</sup> / <sub>16</sub>	3.30
18	80B18SS	6.270	B	1	2 <sup>3</sup> / <sub>8</sub>	4 <sup>1</sup> / <sub>4</sub>	1½	7.34	A	80A18SS	1 <sup>5</sup> / <sub>16</sub>	3.70
19	80B19SS	6.590	B	1	2 <sup>3</sup> / <sub>8</sub>	4 <sup>1</sup> / <sub>4</sub>	1½	7.80	A	80A19SS	1 <sup>5</sup> / <sub>16</sub>	4.10
20	80B20SS	6.910	B	1	2 <sup>3</sup> / <sub>8</sub>	4 <sup>1</sup> / <sub>4</sub>	1½	8.22	A	80A20SS	1 <sup>5</sup> / <sub>16</sub>	4.70
21	80B21SS	7.240	B	1	2 <sup>3</sup> / <sub>8</sub>	4 <sup>1</sup> / <sub>4</sub>	1 <sup>3</sup> / <sub>4</sub>	9.40	A	80A21SS	1 <sup>5</sup> / <sub>16</sub>	5.10
22	80B22SS	7.560	B	1	2 <sup>3</sup> / <sub>8</sub>	4 <sup>1</sup> / <sub>4</sub>	1 <sup>3</sup> / <sub>4</sub>	10.00	A	80A22SS	1 <sup>5</sup> / <sub>16</sub>	5.61
23	80B23SS	7.880	B	1	2 <sup>3</sup> / <sub>8</sub>	4 <sup>1</sup> / <sub>4</sub>	1 <sup>3</sup> / <sub>4</sub>	10.70	A	80A23SS	1 <sup>5</sup> / <sub>16</sub>	6.10
24	80B24SS	8.200	B	1	2 <sup>3</sup> / <sub>8</sub>	4 <sup>1</sup> / <sub>4</sub>	1 <sup>3</sup> / <sub>4</sub>	11.36	A	80A24SS	1 <sup>5</sup> / <sub>16</sub>	6.73
25	80B25SS	8.520	B	1	2 <sup>3</sup> / <sub>8</sub>	4 <sup>1</sup> / <sub>4</sub>	1 <sup>3</sup> / <sub>4</sub>	11.90	A	80A25SS	1 <sup>5</sup> / <sub>16</sub>	7.26
26	80B26SS	8.840	B	1 <sup>1</sup> / <sub>4</sub>	3 <sup>1</sup> / <sub>4</sub>	4 <sup>1</sup> / <sub>4</sub>	2	14.57	A	80A26SS	1 <sup>3</sup> / <sub>16</sub>	6.73
30	80B30SS	10.110	B	1 <sup>1</sup> / <sub>8</sub>	3 <sup>1</sup> / <sub>4</sub>	4 <sup>1</sup> / <sub>4</sub>	2	17.50	A	80A30SS	1 <sup>3</sup> / <sub>16</sub>	10.53
35	80B35SS	11.710	B	1 <sup>1</sup> / <sub>8</sub>	3 <sup>1</sup> / <sub>4</sub>	4 <sup>1</sup> / <sub>4</sub>	2	21.48	A	80A35SS	1 <sup>3</sup> / <sub>16</sub>	13.07
40	80B40SS	13.310	B	1 <sup>1</sup> / <sub>8</sub>	3 <sup>1</sup> / <sub>4</sub>	4 <sup>1</sup> / <sub>4</sub>	2	26.00	A	80A40SS	1 <sup>3</sup> / <sub>16</sub>	19.22

★ Has recessed groove in hub for chain clearance.

Maximum bores shown will accommodate standard keyseat and setscrew over keyseat. Slightly larger bores are possible with no keyseat, shallow keyseat, or setscrew at angle to keyseat.



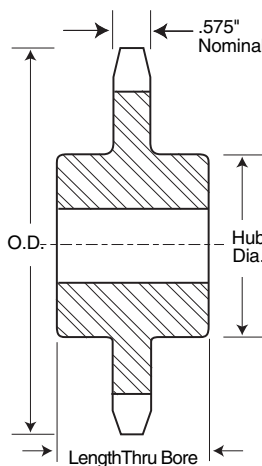
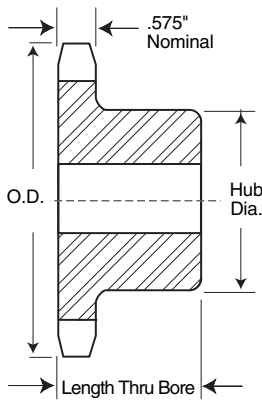
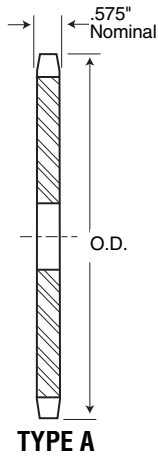

**TYPE C**

### Single - Type B & C

### Single - Type A

No. Teeth	Catalog Number	Outside Diameter	Type	Bore (inches)		Hub (inches)		Weight Lbs (Approx.)	Type	Catalog Number	Stock Bore	Weight Lbs. (Approx.)
				Stock	Rec. Max.	Dia.	Length Thru					
8	80B8	3.010	B	1	1	1 <sup>1</sup> / <sub>16</sub> ★	1 <sup>1</sup> / <sub>8</sub>	1.4	-	-	-	-
9	80B9	3.350	B	1	1 <sup>1</sup> / <sub>16</sub>	2 <sup>1</sup> / <sub>16</sub> ★	1 <sup>1</sup> / <sub>8</sub>	1.6	A	80A9	1 <sup>1</sup> / <sub>16</sub>	.8
10	80B10	3.680	B	1	1 <sup>1</sup> / <sub>2</sub>	2 <sup>1</sup> / <sub>16</sub> ★	1 <sup>1</sup> / <sub>8</sub>	2.2	A	80A10	1 <sup>1</sup> / <sub>16</sub>	1.0
11	80B11	4.010	B	1	1 <sup>1</sup> / <sub>2</sub>	2 <sup>1</sup> / <sub>16</sub> ★	1 <sup>1</sup> / <sub>8</sub>	3.2	A	80A11	1 <sup>1</sup> / <sub>16</sub>	1.3
12	80B12	4.330	B	1	1 <sup>1</sup> / <sub>2</sub>	3 <sup>1</sup> / <sub>16</sub> ★	1 <sup>1</sup> / <sub>8</sub>	3.4	A	80A12	1 <sup>1</sup> / <sub>16</sub>	1.5
13	80B13	4.660	B	1	2	3	1 <sup>1</sup> / <sub>8</sub>	3.5	A	80A13	1 <sup>1</sup> / <sub>16</sub>	1.8
14	80B14	4.980	B	1	2 <sup>1</sup> / <sub>4</sub>	3 <sup>1</sup> / <sub>16</sub>	1 <sup>1</sup> / <sub>8</sub>	4.1	A	80A14	1 <sup>1</sup> / <sub>16</sub>	2.2
15	80B15	5.300	B	1	2 <sup>1</sup> / <sub>4</sub>	3 <sup>1</sup> / <sub>16</sub>	1 <sup>1</sup> / <sub>8</sub>	5.3	A	80A15	1 <sup>1</sup> / <sub>16</sub>	2.5
16	80B16	5.630	B	1	2 <sup>3</sup> / <sub>4</sub>	4	1 <sup>1</sup> / <sub>2</sub>	5.9	A	80A16	1 <sup>1</sup> / <sub>16</sub>	2.9
17	80B17	5.950	B	1	2 <sup>3</sup> / <sub>4</sub>	4	1 <sup>1</sup> / <sub>2</sub>	6.6	A	80A17	1 <sup>1</sup> / <sub>16</sub>	3.3
18	80B18	6.270	B	1	2 <sup>3</sup> / <sub>4</sub>	4 <sup>1</sup> / <sub>16</sub>	1 <sup>1</sup> / <sub>2</sub>	7.3	A	80A18	1 <sup>1</sup> / <sub>16</sub>	3.7
19	80B19	6.590	B	1	2 <sup>3</sup> / <sub>4</sub>	4 <sup>1</sup> / <sub>16</sub>	1 <sup>1</sup> / <sub>2</sub>	7.8	A	80A19	1 <sup>1</sup> / <sub>16</sub>	4.1
20	80B20	6.910	B	1	2 <sup>3</sup> / <sub>4</sub>	4 <sup>1</sup> / <sub>16</sub>	1 <sup>1</sup> / <sub>2</sub>	8.4	A	80A20	1 <sup>1</sup> / <sub>16</sub>	4.7
21	80B21	7.240	B	1	2 <sup>3</sup> / <sub>4</sub>	4 <sup>1</sup> / <sub>16</sub>	1 <sup>1</sup> / <sub>2</sub>	9.4	A	80A21	1 <sup>1</sup> / <sub>16</sub>	4.9
22	80B22	7.560	B	1	2 <sup>3</sup> / <sub>4</sub>	4 <sup>1</sup> / <sub>16</sub>	1 <sup>1</sup> / <sub>2</sub>	10.0	A	80A22	1 <sup>1</sup> / <sub>16</sub>	5.5
23	80B23	7.880	B	1	2 <sup>3</sup> / <sub>4</sub>	4 <sup>1</sup> / <sub>16</sub>	1 <sup>1</sup> / <sub>2</sub>	10.7	A	80A23	1 <sup>1</sup> / <sub>16</sub>	6.3
24	80B24	8.200	B	1	2 <sup>3</sup> / <sub>4</sub>	4 <sup>1</sup> / <sub>16</sub>	1 <sup>1</sup> / <sub>2</sub>	11.3	A	80A24	1 <sup>1</sup> / <sub>16</sub>	6.7
25	80B25	8.520	B	1	2 <sup>3</sup> / <sub>4</sub>	4 <sup>1</sup> / <sub>16</sub>	1 <sup>1</sup> / <sub>2</sub>	11.9	A	80A25	1 <sup>1</sup> / <sub>16</sub>	7.2
26	80B26	8.840	B	1 <sup>1</sup> / <sub>16</sub>	3 <sup>1</sup> / <sub>4</sub>	4 <sup>1</sup> / <sub>16</sub>	2	14.3	A	80A26	1 <sup>1</sup> / <sub>16</sub>	7.8
27	80B27	9.160	B	1 <sup>1</sup> / <sub>16</sub>	3 <sup>1</sup> / <sub>4</sub>	4 <sup>1</sup> / <sub>16</sub>	2	15.4	A	80A27	1 <sup>1</sup> / <sub>16</sub>	8.6
28	80B28	9.480	B	1 <sup>1</sup> / <sub>16</sub>	3 <sup>1</sup> / <sub>4</sub>	4 <sup>1</sup> / <sub>16</sub>	2	16.0	A	80A28	1 <sup>1</sup> / <sub>16</sub>	9.3
29	80B29	9.800	B	1 <sup>1</sup> / <sub>16</sub>	3 <sup>1</sup> / <sub>4</sub>	4 <sup>1</sup> / <sub>16</sub>	2	17.1	A	80A29	1 <sup>1</sup> / <sub>16</sub>	9.8
30	80B30	10.110	B	1 <sup>1</sup> / <sub>16</sub>	3 <sup>1</sup> / <sub>4</sub>	4 <sup>1</sup> / <sub>16</sub>	2	17.4	A	80A30	1 <sup>1</sup> / <sub>16</sub>	10.7
31	80B31	10.430	B	1 <sup>1</sup> / <sub>16</sub>	3 <sup>1</sup> / <sub>4</sub>	4 <sup>1</sup> / <sub>16</sub>	2	18.7	A	80A31	1 <sup>1</sup> / <sub>16</sub>	11.3
32	80B32	10.750	B	1 <sup>1</sup> / <sub>16</sub>	3 <sup>1</sup> / <sub>4</sub>	4 <sup>1</sup> / <sub>16</sub>	2	19.5	A	80A32	1 <sup>1</sup> / <sub>16</sub>	12.1
33	80B33	11.070	B	1 <sup>1</sup> / <sub>16</sub>	3 <sup>1</sup> / <sub>4</sub>	4 <sup>1</sup> / <sub>16</sub>	2	19.6	A	80A33	1 <sup>1</sup> / <sub>16</sub>	13.6
34	80B34	11.390	B	1 <sup>1</sup> / <sub>16</sub>	3 <sup>1</sup> / <sub>4</sub>	4 <sup>1</sup> / <sub>16</sub>	2	21.3	A	80A34	1 <sup>1</sup> / <sub>16</sub>	14.3
35	80B35	11.710	B	1 <sup>1</sup> / <sub>16</sub>	3 <sup>1</sup> / <sub>4</sub>	4 <sup>1</sup> / <sub>16</sub>	2	22.1	A	80A35	1 <sup>1</sup> / <sub>16</sub>	14.8
36	80B36	12.030	B	1 <sup>1</sup> / <sub>16</sub>	3 <sup>1</sup> / <sub>4</sub>	4 <sup>1</sup> / <sub>16</sub>	2	23.1	A	80A36	1 <sup>1</sup> / <sub>16</sub>	16.1
37	80B37	12.350	B	1 <sup>1</sup> / <sub>16</sub>	3 <sup>1</sup> / <sub>4</sub>	4 <sup>1</sup> / <sub>16</sub>	2	23.8	A	80A37	1 <sup>1</sup> / <sub>16</sub>	16.8
38	80B38	12.670	B	1 <sup>1</sup> / <sub>16</sub>	3 <sup>1</sup> / <sub>4</sub>	4 <sup>1</sup> / <sub>16</sub>	2	24.7	A	80A38	1 <sup>1</sup> / <sub>16</sub>	17.2
39	80B39	12.990	B	1 <sup>1</sup> / <sub>16</sub>	3 <sup>1</sup> / <sub>4</sub>	4 <sup>1</sup> / <sub>16</sub>	2	25.6	A	80A39	1 <sup>1</sup> / <sub>16</sub>	17.9
40	80B40	13.310	B	1 <sup>1</sup> / <sub>16</sub>	3 <sup>1</sup> / <sub>4</sub>	4 <sup>1</sup> / <sub>16</sub>	2	26.7	A	80A40	1 <sup>1</sup> / <sub>16</sub>	18.9
41	80B41	13.630	B	1 <sup>1</sup> / <sub>16</sub>	3 <sup>1</sup> / <sub>4</sub>	4 <sup>1</sup> / <sub>16</sub>	2	27.8	A	80A41	1 <sup>1</sup> / <sub>16</sub>	21.0
42	80B42	13.940	B	1 <sup>1</sup> / <sub>16</sub>	3 <sup>1</sup> / <sub>4</sub>	4 <sup>1</sup> / <sub>16</sub>	2	28.7	A	80A42	1 <sup>1</sup> / <sub>16</sub>	21.8
43	80B43	14.260	B	1 <sup>1</sup> / <sub>16</sub>	3 <sup>1</sup> / <sub>4</sub>	4 <sup>1</sup> / <sub>16</sub>	2	29.4	A	80A43	1 <sup>1</sup> / <sub>16</sub>	23.6
44	80B44	14.580	B	1 <sup>1</sup> / <sub>16</sub>	3 <sup>1</sup> / <sub>4</sub>	4 <sup>1</sup> / <sub>16</sub>	2	29.9	A	80A44	1 <sup>1</sup> / <sub>16</sub>	24.3
45	80B45	14.900	B	1 <sup>1</sup> / <sub>16</sub>	3 <sup>1</sup> / <sub>4</sub>	4 <sup>1</sup> / <sub>16</sub>	2	31.4	A	80A45	1 <sup>1</sup> / <sub>16</sub>	25.2
46	80B46	15.220	B	1 <sup>1</sup> / <sub>16</sub>	3 <sup>1</sup> / <sub>4</sub>	4 <sup>1</sup> / <sub>16</sub>	2	33.1	A	80A46	1 <sup>1</sup> / <sub>16</sub>	26.6
47	80B47	15.540	B	1 <sup>1</sup> / <sub>16</sub>	3 <sup>1</sup> / <sub>4</sub>	4 <sup>1</sup> / <sub>16</sub>	2	34.0	A	80A47	1 <sup>1</sup> / <sub>16</sub>	26.4
48	80B48	15.860	B	1 <sup>1</sup> / <sub>16</sub>	3 <sup>1</sup> / <sub>4</sub>	4 <sup>1</sup> / <sub>16</sub>	2	35.5	A	80A48	1 <sup>1</sup> / <sub>16</sub>	27.8
49	80B49	16.180	B	1 <sup>1</sup> / <sub>16</sub>	3 <sup>1</sup> / <sub>4</sub>	4 <sup>1</sup> / <sub>16</sub>	2	35.8	A	80A49	1 <sup>1</sup> / <sub>16</sub>	28.9
50	80B50	16.500	B	1 <sup>1</sup> / <sub>16</sub>	3 <sup>1</sup> / <sub>4</sub>	4 <sup>1</sup> / <sub>16</sub>	2	37.3	A	80A50	1 <sup>1</sup> / <sub>16</sub>	30.9
51	80B51	16.810	B	1 <sup>1</sup> / <sub>16</sub>	3 <sup>1</sup> / <sub>4</sub>	4 <sup>1</sup> / <sub>16</sub>	2	38.6	A	80A51	1 <sup>1</sup> / <sub>16</sub>	32.2
52	80B52	17.130	B	1 <sup>1</sup> / <sub>16</sub>	3 <sup>1</sup> / <sub>4</sub>	4 <sup>1</sup> / <sub>16</sub>	2	39.4	A	80A52	1 <sup>1</sup> / <sub>16</sub>	33.0
53	80B53	17.450	B	1 <sup>1</sup> / <sub>16</sub>	3 <sup>1</sup> / <sub>4</sub>	4 <sup>1</sup> / <sub>16</sub>	2	41.3	A	80A53	1 <sup>1</sup> / <sub>16</sub>	34.9
54	80B54	17.770	B	1 <sup>1</sup> / <sub>16</sub>	3 <sup>1</sup> / <sub>4</sub>	5 <sup>1</sup> / <sub>16</sub>	2	44.7	A	80A54	1 <sup>1</sup> / <sub>16</sub>	36.6
55	80B55	18.090	B	1 <sup>1</sup> / <sub>16</sub>	3 <sup>1</sup> / <sub>2</sub>	5 <sup>1</sup> / <sub>16</sub>	2	45.6	A	80A55	1 <sup>1</sup> / <sub>16</sub>	37.5
56	80B56	18.410	B	1 <sup>1</sup> / <sub>16</sub>	3 <sup>1</sup> / <sub>2</sub>	5 <sup>1</sup> / <sub>16</sub>	2	47.5	A	80A56	1 <sup>1</sup> / <sub>16</sub>	39.4
57	80B57	18.730	B	1 <sup>1</sup> / <sub>16</sub>	3 <sup>1</sup> / <sub>2</sub>	5 <sup>1</sup> / <sub>16</sub>	2	48.5	A	80A57	1 <sup>1</sup> / <sub>16</sub>	40.4
58	80B58	19.040	B	1 <sup>1</sup> / <sub>16</sub>	3 <sup>1</sup> / <sub>2</sub>	5 <sup>1</sup> / <sub>16</sub>	2	50.5	A	80A58	1 <sup>1</sup> / <sub>16</sub>	41.3
59	80B59	19.360	B	1 <sup>1</sup> / <sub>16</sub>	3 <sup>1</sup> / <sub>2</sub>	5 <sup>1</sup> / <sub>16</sub>	2	52.1	A	80A59	1 <sup>1</sup> / <sub>16</sub>	42.9
60	80B60	19.680	B	1 <sup>1</sup> / <sub>16</sub>	3 <sup>1</sup> / <sub>2</sub>	5 <sup>1</sup> / <sub>16</sub>	2	54.5	A	80A60	1 <sup>1</sup> / <sub>16</sub>	45.3
65	80B65	21.270	B	1 <sup>1</sup> / <sub>16</sub>	3 <sup>1</sup> / <sub>2</sub>	5 <sup>1</sup> / <sub>16</sub>	2	61.8	A	80A65	1 <sup>1</sup> / <sub>16</sub>	52.2
70	80C70	22.870	C	1 <sup>1</sup> / <sub>2</sub>	4 <sup>1</sup> / <sub>16</sub>	6 <sup>1</sup> / <sub>16</sub>	3 <sup>1</sup> / <sub>2</sub>	75.7	A	80A70	1 <sup>1</sup> / <sub>2</sub>	59.8
72	80C72	23.500	C	1 <sup>1</sup> / <sub>2</sub>	4 <sup>1</sup> / <sub>16</sub>	6 <sup>1</sup> / <sub>16</sub>	3 <sup>1</sup> / <sub>2</sub>	81.4	A	80A72	1 <sup>1</sup> / <sub>2</sub>	65.7
76	80C76	24.780	C	1 <sup>1</sup> / <sub>2</sub>	4 <sup>1</sup> / <sub>16</sub>	6 <sup>1</sup> / <sub>16</sub>	3 <sup>1</sup> / <sub>2</sub>	87.8	A	80A76	1 <sup>1</sup> / <sub>2</sub>	70.2
80	80C80	26.050	C	1 <sup>1</sup> / <sub>2</sub>	4 <sup>1</sup> / <sub>16</sub>	6 <sup>1</sup> / <sub>16</sub>	3 <sup>1</sup> / <sub>2</sub>	89.9	A	80A80	1 <sup>1</sup> / <sub>2</sub>	79.6
84	80C84	27.330	C	1 <sup>1</sup> / <sub>2</sub>	4 <sup>1</sup> / <sub>16</sub>	6 <sup>1</sup> / <sub>16</sub>	3 <sup>1</sup> / <sub>2</sub>	99.2	A	80A84	1 <sup>1</sup> / <sub>2</sub>	86.1
90	80C90	29.240	C	1 <sup>1</sup> / <sub>2</sub>	4 <sup>1</sup> / <sub>16</sub>	6 <sup>1</sup> / <sub>16</sub>	3 <sup>1</sup> / <sub>2</sub>	106.0	A	80A90	1 <sup>1</sup> / <sub>2</sub>	101.0
96	80C96	31.150	C	1 <sup>1</sup> / <sub>2</sub>	4 <sup>1</sup> / <sub>16</sub>	6 <sup>1</sup> / <sub>16</sub>	3 <sup>1</sup> / <sub>2</sub>	117.0	A	80A96	1 <sup>1</sup> / <sub>2</sub>	120.0
112	80C112	36.240	C	1 <sup>1</sup> / <sub>2</sub>	4 <sup>1</sup> / <sub>16</sub>	6 <sup>1</sup> / <sub>16</sub>	3 <sup>1</sup> / <sub>2</sub>	154.0	A	80A112	1 <sup>1</sup> / <sub>2</sub>	165.0

★ Has recessed groove in hub for chain clearance.

Maximum bores shown will accommodate standard keyseat and setscrew over keyseat. Slightly larger bores are possible with no keyseat, shallow keyseat, or setscrew at angle to keyseat.

# No. 80 1" Pitch

# All Steel Stock Sprockets

# Martin

## Single - Type QD With Hardened Teeth

No. Teeth	Catalog Number
11	80SH11H
12	80SH12H
13	80SDS13H
14	80SDS14H
15	80SK15H
16	80SK16H
17	80SK17H
18	80SK18H
19	80SK19H
20	80SF20H
21	80SF21H
22	80SF22H
23	80SF23H
24	80SF24H
25	80SF25H
26	80SF26H
27	80SF27H
28	80SF28H
30	80SF30H

**SABER  
TOOTH®**

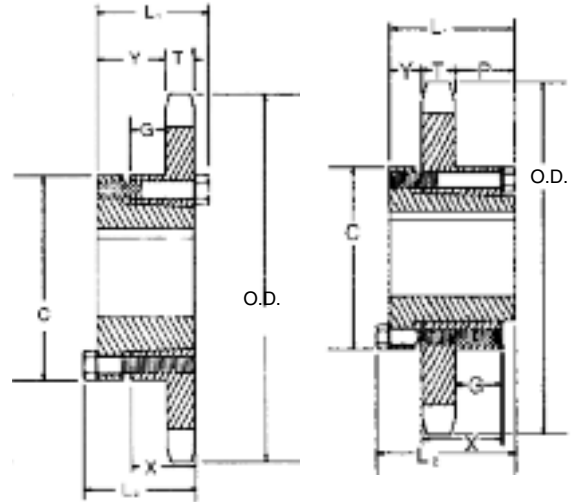

QD — TYPE B

QD — TYPE C

## Single - Type QD

No. Teeth	Catalog Number	Bush- ing	Diameters		Type	Max. Bore	Dimensions								Weight Lbs. (Approx.)	
			Outside Diameter	Pitch Diameter			L <sub>1</sub>	L <sub>2</sub>	C	Y	P	G	X	T	With Hub	Rim Only
11	80SH11	SH	4.010	3.550	B	1 $\frac{1}{16}$	1 $\frac{1}{16}$	1 $\frac{1}{16}$	2 $\frac{1}{16}$	2 $\frac{1}{32}$	—	1 $\frac{1}{64}$	1 $\frac{1}{16}$	0.575	2.0	1.0
12	80SH12	SH	4.330	3.864	B	1 $\frac{1}{16}$	1 $\frac{1}{16}$	1 $\frac{1}{16}$	2 $\frac{1}{16}$	2 $\frac{1}{32}$	—	1 $\frac{1}{64}$	1 $\frac{1}{16}$	0.575	2.4	1.4
13	80SDS13	SDS	4.660	4.179	B	2	1 $\frac{1}{2}$	1 $\frac{1}{2}$	3 $\frac{3}{16}$	4 $\frac{1}{64}$	—	1 $\frac{1}{64}$	3 $\frac{1}{4}$	0.575	2.5	1.5
14	80SDS14	SDS	4.980	4.494	B	2	1 $\frac{1}{2}$	1 $\frac{1}{2}$	3 $\frac{3}{16}$	4 $\frac{1}{64}$	—	1 $\frac{1}{64}$	3 $\frac{1}{4}$	0.575	2.8	1.8
15	80SK15	SK	5.300	4.810	B	2 $\frac{1}{8}$	2 $\frac{1}{8}$	2 $\frac{1}{8}$	3 $\frac{1}{8}$	1 $\frac{19}{64}$	—	2 $\frac{1}{32}$	1 $\frac{1}{4}$	0.575	4.5	2.5
16	80SK16	SK	5.630	5.126	B	2 $\frac{1}{8}$	2 $\frac{1}{8}$	2 $\frac{1}{8}$	3 $\frac{1}{8}$	1 $\frac{19}{64}$	—	2 $\frac{1}{32}$	1 $\frac{1}{4}$	0.575	5.1	3.1
17	80SK17	SK	5.950	5.442	B	2 $\frac{1}{8}$	2 $\frac{1}{8}$	2 $\frac{1}{8}$	3 $\frac{1}{8}$	1 $\frac{19}{64}$	—	2 $\frac{1}{32}$	1 $\frac{1}{4}$	0.575	5.5	3.5
18	80SK18	SK	6.270	5.759	B	2 $\frac{1}{8}$	2 $\frac{1}{8}$	2 $\frac{1}{8}$	3 $\frac{1}{8}$	1 $\frac{19}{64}$	—	2 $\frac{1}{32}$	1 $\frac{1}{4}$	0.575	5.9	3.9
19	80SK19	SK	6.590	6.076	B	2 $\frac{1}{8}$	2 $\frac{1}{8}$	2 $\frac{1}{8}$	3 $\frac{1}{8}$	1 $\frac{19}{64}$	—	2 $\frac{1}{32}$	1 $\frac{1}{4}$	0.575	6.4	4.4
20	80SF20	SF	6.910	6.392	B	2 $\frac{1}{8}$	2 $\frac{1}{4}$	2 $\frac{1}{4}$	4 $\frac{1}{8}$	1 $\frac{27}{64}$	—	2 $\frac{1}{32}$	1 $\frac{1}{4}$	0.575	8.3	5.3
21	80SF21	SF	7.240	6.710	B	2 $\frac{1}{8}$	2 $\frac{1}{4}$	2 $\frac{1}{4}$	4 $\frac{1}{8}$	1 $\frac{27}{64}$	—	2 $\frac{1}{32}$	1 $\frac{1}{4}$	0.575	8.7	5.7
22	80SF22	SF	7.560	7.027	B	2 $\frac{1}{8}$	2 $\frac{1}{4}$	2 $\frac{1}{4}$	4 $\frac{1}{8}$	1 $\frac{27}{64}$	—	2 $\frac{1}{32}$	1 $\frac{1}{4}$	0.575	9.3	6.3
23	80SF23	SF	7.880	7.344	B	2 $\frac{1}{8}$	2 $\frac{1}{4}$	2 $\frac{1}{4}$	4 $\frac{1}{8}$	1 $\frac{27}{64}$	—	2 $\frac{1}{32}$	1 $\frac{1}{4}$	0.575	9.8	6.8
24	80SF24	SF	8.200	7.661	B	2 $\frac{1}{8}$	2 $\frac{1}{4}$	2 $\frac{1}{4}$	4 $\frac{1}{8}$	1 $\frac{27}{64}$	—	2 $\frac{1}{32}$	1 $\frac{1}{4}$	0.575	10.5	7.5
25	80SF25	SF	8.520	7.979	B	2 $\frac{1}{8}$	2 $\frac{1}{4}$	2 $\frac{1}{4}$	4 $\frac{1}{8}$	1 $\frac{27}{64}$	—	2 $\frac{1}{32}$	1 $\frac{1}{4}$	0.575	11.0	8.0
26	80SF26	SF	8.840	8.296	B	2 $\frac{1}{8}$	2 $\frac{1}{4}$	2 $\frac{1}{4}$	4 $\frac{1}{8}$	1 $\frac{27}{64}$	—	2 $\frac{1}{32}$	1 $\frac{1}{4}$	0.575	11.6	8.6
27	80SF27	SF	9.160	8.614	B	2 $\frac{1}{8}$	2 $\frac{1}{4}$	2 $\frac{1}{4}$	4 $\frac{1}{8}$	1 $\frac{27}{64}$	—	2 $\frac{1}{32}$	1 $\frac{1}{4}$	0.575	12.4	9.4
28	80SF28	SF	9.480	8.931	B	2 $\frac{1}{8}$	2 $\frac{1}{4}$	2 $\frac{1}{4}$	4 $\frac{1}{8}$	1 $\frac{27}{64}$	—	2 $\frac{1}{32}$	1 $\frac{1}{4}$	0.575	13.2	10.2
30	80SF30	SF	10.110	9.567	B	2 $\frac{1}{8}$	2 $\frac{1}{4}$	2 $\frac{1}{4}$	4 $\frac{1}{8}$	1 $\frac{27}{64}$	—	2 $\frac{1}{32}$	1 $\frac{1}{4}$	0.575	14.3	11.3
32	80SF32	SF	10.750	10.202	B	2 $\frac{1}{8}$	2 $\frac{1}{4}$	2 $\frac{1}{4}$	4 $\frac{1}{8}$	1 $\frac{27}{64}$	—	2 $\frac{1}{32}$	1 $\frac{1}{4}$	0.575	16.0	13.0
33	80SF33	SF	11.070	10.520	B	2 $\frac{1}{8}$	2 $\frac{1}{4}$	2 $\frac{1}{4}$	4 $\frac{1}{8}$	1 $\frac{27}{64}$	—	2 $\frac{1}{32}$	1 $\frac{1}{4}$	0.575	16.5	13.5
34	80SF34	SF	11.390	10.838	B	2 $\frac{1}{8}$	2 $\frac{1}{4}$	2 $\frac{1}{4}$	4 $\frac{1}{8}$	1 $\frac{27}{64}$	—	2 $\frac{1}{32}$	1 $\frac{1}{4}$	0.575	17.1	14.1
35	80SF35	SF	11.710	11.156	B	2 $\frac{1}{8}$	2 $\frac{1}{4}$	2 $\frac{1}{4}$	4 $\frac{1}{8}$	1 $\frac{27}{64}$	—	2 $\frac{1}{32}$	1 $\frac{1}{4}$	0.575	18.5	15.5
36	80SF36	SF	12.030	11.474	B	2 $\frac{1}{8}$	2 $\frac{1}{4}$	2 $\frac{1}{4}$	4 $\frac{1}{8}$	1 $\frac{27}{64}$	—	2 $\frac{1}{32}$	1 $\frac{1}{4}$	0.575	19.9	16.9
40	80SF40	SF	13.310	12.746	B	2 $\frac{1}{8}$	2 $\frac{1}{4}$	2 $\frac{1}{4}$	4 $\frac{1}{8}$	1 $\frac{27}{64}$	—	2 $\frac{1}{32}$	1 $\frac{1}{4}$	0.575	23.6	20.6
42	80SF42	SF	13.940	13.382	B	2 $\frac{1}{8}$	2 $\frac{1}{4}$	2 $\frac{1}{4}$	4 $\frac{1}{8}$	1 $\frac{27}{64}$	—	2 $\frac{1}{32}$	1 $\frac{1}{4}$	0.575	25.4	22.4
45	80SF45	SF	14.900	14.336	B	2 $\frac{1}{8}$	2 $\frac{1}{4}$	2 $\frac{1}{4}$	4 $\frac{1}{8}$	1 $\frac{27}{64}$	—	2 $\frac{1}{32}$	1 $\frac{1}{4}$	0.575	28.1	25.1
48	80SF48	SF	15.860	15.290	B	2 $\frac{1}{8}$	2 $\frac{1}{4}$	2 $\frac{1}{4}$	4 $\frac{1}{8}$	1 $\frac{27}{64}$	—	2 $\frac{1}{32}$	1 $\frac{1}{4}$	0.575	31.6	28.6
54	80SF54	SF	17.770	17.198	B	2 $\frac{1}{8}$	2 $\frac{1}{4}$	2 $\frac{1}{4}$	4 $\frac{1}{8}$	1 $\frac{27}{64}$	—	2 $\frac{1}{32}$	1 $\frac{1}{4}$	0.575	39.8	36.8
60	80SF60	SF	19.680	19.107	B	2 $\frac{1}{8}$	2 $\frac{1}{4}$	2 $\frac{1}{4}$	4 $\frac{1}{8}$	1 $\frac{27}{64}$	—	2 $\frac{1}{32}$	1 $\frac{1}{4}$	0.575	48.8	45.8
70	80E70	E	22.870	22.289	C	3 $\frac{1}{2}$	2 $\frac{1}{2}$	2 $\frac{1}{2}$	6	3 $\frac{1}{8}$	1 $\frac{1}{16}$	1 $\frac{1}{64}$	1 $\frac{1}{8}$	0.575	65.6	55.6
72	80E72	E	23.500	22.926	C	3 $\frac{1}{2}$	2 $\frac{1}{2}$	2 $\frac{1}{2}$	6	3 $\frac{1}{8}$	1 $\frac{1}{16}$	1 $\frac{1}{64}$	1 $\frac{1}{8}$	0.575	69.3	59.3
80	80E80	E	26.050	25.471	C	3 $\frac{1}{2}$	2 $\frac{1}{2}$	2 $\frac{1}{2}$	6	3 $\frac{1}{8}$	1 $\frac{1}{16}$	1 $\frac{1}{64}$	1 $\frac{1}{8}$	0.575	79.2	69.2
84	80E84	E	27.330	26.744	C	3 $\frac{1}{2}$	2 $\frac{1}{2}$	2 $\frac{1}{2}$	6	3 $\frac{1}{8}$	1 $\frac{1}{16}$	1 $\frac{1}{64}$	1 $\frac{1}{8}$	0.575	84.9	74.9
96	80E96	E	31.150	30.563	C	3 $\frac{1}{2}$	2 $\frac{1}{2}$	2 $\frac{1}{2}$	6	3 $\frac{1}{8}$	1 $\frac{1}{16}$	1 $\frac{1}{64}$	1 $\frac{1}{8}$	0.575	108.0	97.5
112	80F112	F	36.240	35.655	C	3 $\frac{1}{2}$	3 $\frac{1}{2}$	4	6 $\frac{1}{2}$	1	2 $\frac{1}{16}$	1 $\frac{1}{64}$	2 $\frac{1}{2}$	0.575	145.0	134.0

### Single - Taper Bushed with Hardened Teeth

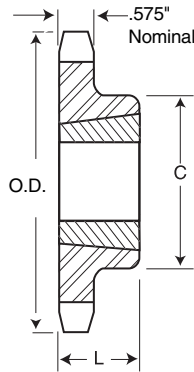

TYPE B



No. Teeth	Catalog Number
10	80BTB10H
11	80BTB11H
12	80BTB12H
13	80BTB13H
14	80BTB14H
15	80BTB15H
16	80BTB16H
17	80BTB17H
18	80BTB18H
19	80BTB19H
20	80BTB20H
21	80BTB21H
22	80BTB22H
23	80BTB23H
24	80BTB24H
25	80BTB25H
26	80BTB26H
27	80BTB27H
28	80BTB28H
30	80BTB30H

S  
A  
B  
E  
R  
  
T  
O  
O  
T  
H<sup>®</sup>

### Single - Taper Bushed

No. Teeth	Catalog Number	Bushing	Diameter		Max. Bore	Dimensions		Type	Weight Lbs. (Approx.)	
			Outside Diameter	Pitch Diameter		L	C		Rim Only	Bushing Only
10	80BTB10	1215	3.678	3.236	1 1/4	1 1/2	2 1/2 ★	B	1.1	0.8
11	80BTB11	1215	4.006	3.549	1 1/4	1 1/2	2 1/2 ★	B	1.5	0.8
12	80BTB12	1615	4.332	3.864	1 1/4	1 1/2	3 ★	B	1.8	1.2
13	80BTB13	1615	4.657	4.179	1 1/4	1 1/2	3	B	2.3	1.2
14	80BTB14	1615	4.982	4.494	1 1/4	1 1/2	3 1/2	B	2.5	1.2
15	80BTB15	1615	5.305	4.810	1 1/4	1 1/2	3 1/2	B	2.7	1.2
16	80BTB16	2012	5.627	5.126	2	1 1/4	4	B	2.8	1.7
17	80BTB17	2012	5.950	5.442	2	1 1/4	4	B	3.1	1.7
18	80BTB18	2012	6.271	5.759	2	1 1/4	3 3/8	B	2.6	1.7
19	80BTB19	2012	6.593	6.076	2	1 1/4	3 3/8	B	4.1	1.7
20	80BTB20	2517	6.914	6.392	2 1/2	1 1/4	4 1/4	B	5.5	1.7
21	80BTB21	2517	7.235	6.710	2 1/2	1 1/4	4 1/4	B	6.0	3.5
22	80BTB22	2517	7.555	7.027	2 1/2	1 1/4	4 1/4	B	6.5	3.5
23	80BTB23	2517	7.875	7.344	2 1/2	1 1/4	4 1/4	B	7.0	3.5
24	80BTB24	2517	8.196	7.661	2 1/2	1 1/4	4 1/4	B	7.5	3.5
25	80BTB25	2517	8.516	7.979	2 1/2	1 1/4	4 1/4	B	8.1	3.5
26	80BTB26	2517	8.836	8.296	2 1/2	1 1/4	4 1/4	B	8.8	3.5
27	80BTB27	2517	9.156	8.614	2 1/2	1 1/4	4 1/4	B	9.0	3.5
28	80BTB28	2517	9.475	8.931	2 1/2	1 1/4	4 1/4	B	9.5	3.5
30	80BTB30	2517	10.114	9.567	2 1/2	1 1/4	4 1/4	B	11.5	3.5
32	80BTB32	2517	10.753	10.202	2 1/2	1 1/4	4 1/4	B	12.0	3.5
35	80BTB35	2517	11.711	11.156	2 1/2	1 1/4	4 1/4	B	15.2	3.5
36	80BTB36	2517	12.030	11.474	2 1/2	1 1/4	4 1/4	B	17.0	3.5
40	80BTB40	2517	13.306	12.746	2 1/2	1 1/4	4 1/4	B	21.0	3.5
45	80BTB45	2517	14.901	14.336	2 1/2	1 1/4	4 1/4	B	26.5	3.5
48	80BTB48	2517	15.857	15.290	2 1/2	1 1/4	4 1/4	B	29.5	3.5
54	80BTB54	2517	17.769	17.198	2 1/2	1 1/4	4 1/4	B	38.5	3.5
60	80BTB60	2517	19.681	19.107	2 1/2	1 1/4	4 1/4	B	45.0	3.5
70	80BTB70	3020	22.867	22.289	3	2	5 1/4	B	52.3	6.5
80	80BTB80	3020	26.052	25.471	3	2	5 1/4	B	69.2	6.5

★ Has recessed groove in hub for chain clearance.

# No. 80 1" Pitch

# MST® Sprockets

# Martin

## Single - MST® Sprockets

No. Teeth	Catalog Number	Bush-ing	Diameters		Type	Max. Bore	Dimensions						Weight Lbs. (Approx.)	
			Outside Dia.	Pitch Dia.			OL	L	C	H	P	T(nom)	With Hub	Rim Only
10	80H10H	H	3.680	3.236	3	1-1/2	2-3/32	1-1/4	21/32	2-1/2	1-21/64	0.575	2.8	2.0
11	80H11H	H	4.010	3.550	3	1-1/2	1-1/2	1-1/4	1/16	2-1/2	3/4	0.575	2.1	1.3
11	80P11H	P	4.010	3.550	4	1-3/4	2-11/32	1-15/16	5/32	3	1-17/32	0.575	2.4	1.6
12	80P12H	P1	4.330	3.864	4	1-3/4	2-3/16	1-15/16	0	3	1-3/8	0.575	3.3	2.0
13	80P13H	P1	4.660	4.179	4	1-3/4	2-3/16	1-15/16	0	3	1-3/8	0.575	3.7	2.4
14	80P14H	P1	4.980	4.494	4	1-3/4	2-3/16	1-15/16	0	3	1-3/8	0.575	3.9	2.6
14	80Q14H	Q1	4.980	4.494	4	2-11/16	2-25/32	2-1/2	0	4-1/8	1-15/16	0.575	6.4	2.9
15	80P15H	P1	5.300	4.810	4	1-3/4	2-3/16	1-15/16	0	3	1-3/8	0.575	4.3	3.0
15	80Q15H	Q1	5.300	4.810	4	2-11/16	2-25/32	2-1/2	0	4-1/8	1-15/16	0.575	6.9	3.4
16	80P16H	P1	5.630	5.126	4	1-3/4	2-3/16	1-15/16	0	3	1-3/8	0.575	4.8	3.5
16	80Q16H	Q1	5.630	5.126	4	2-11/16	2-25/32	2-1/2	0	4-1/8	1-15/16	0.575	8.1	4.6
17	80P17H	P1	5.950	5.442	4	1-3/4	2-3/16	1-15/16	0	3	1-3/8	0.575	5.1	3.8
17	80Q17H	Q1	5.950	5.442	4	2-11/16	2-25/32	2-1/2	0	4-1/8	1-15/16	0.575	8.8	5.3
18	80P18H	P1	6.270	5.759	4	1-3/4	2-3/16	1-15/16	0	3	1-3/8	0.575	5.7	4.4
18	80Q18H	Q1	6.270	5.759	4	2-11/16	2-25/32	2-1/2	0	4-1/8	1-15/16	0.575	9.5	6.0
19	80P19H	P1	6.590	6.076	4	1-3/4	2-3/16	1-15/16	0	3	1-3/8	0.575	6.2	4.9
19	80Q19H	Q1	6.590	6.076	4	2-11/16	2-25/32	2-1/2	0	4-1/8	1-15/16	0.575	10.0	6.5
20	80Q20H	Q1	6.910	6.392	4	2-11/16	2-25/32	2-1/2	0	4-1/8	1-15/16	0.575	10.5	7.0
21	80Q21H	Q1	7.240	6.710	4	2-11/16	2-25/32	2-1/2	0	4-1/8	1-15/16	0.575	10.8	7.3
22	80Q22H	Q1	7.560	7.027	4	2-11/16	2-25/32	2-1/2	0	4-1/8	1-15/16	0.575	11.7	8.2
23	80Q23H	Q1	7.880	7.344	4	2-11/16	2-25/32	2-1/2	0	4-1/8	1-15/16	0.575	12.3	8.8
24	80Q24H	Q1	8.200	7.661	4	2-11/16	2-25/32	2-1/2	0	4-1/8	1-15/16	0.575	12.6	9.1
25	80Q25H	Q1	8.520	7.979	4	2-11/16	2-25/32	2-1/2	0	4-1/8	1-15/16	0.575	13.1	9.6
26	80Q26H	Q1	8.840	8.296	4	2-11/16	2-25/32	2-1/2	0	4-1/8	1-15/16	0.575	14.1	10.6
27	80Q27H	Q1	9.160	8.614	4	2-11/16	2-25/32	2-1/2	0	4-1/8	1-15/16	0.575	14.4	10.9
28	80Q28H	Q1	9.480	8.931	4	2-11/16	2-25/32	2-1/2	0	4-1/8	1-15/16	0.575	15.9	12.4
29	80Q29H	Q1	9.800	9.249	4	2-11/16	2-25/32	2-1/2	0	4-1/8	1-15/16	0.575	16.1	12.6
30	80Q30H	Q1	10.110	9.567	4	2-11/16	2-25/32	2-1/2	0	4-1/8	1-15/16	0.575	16.9	13.4
31	80Q31	Q1	10.430	9.885	4	2-11/16	2-25/32	2-1/2	0	4-1/8	1-15/16	0.575	17.4	13.9
32	80Q32	Q1	10.750	10.202	4	2-11/16	2-25/32	2-1/2	0	4-1/8	1-15/16	0.575	18.3	14.8
33	80Q33	Q1	11.070	10.520	4	2-11/16	2-25/32	2-1/2	0	4-1/8	1-15/16	0.575	19.0	15.5
34	80Q34	Q1	11.390	10.838	4	2-11/16	2-25/32	2-1/2	0	4-1/8	1-15/16	0.575	19.8	16.3
35	80Q35	Q1	11.710	11.156	4	2-11/16	2-25/32	2-1/2	0	4-1/8	1-15/16	0.575	21.3	17.8
36	80Q36	Q1	12.030	11.474	4	2-11/16	2-25/32	2-1/2	0	4-1/8	1-15/16	0.575	21.6	18.1
36	80R36	R1	12.030	11.474	4	3-3/4	3-5/32	2-7/8	0	5-3/8	2-5/16	0.575	27.0	19.5
37	80Q37	Q1	12.350	11.792	4	2-11/16	2-25/32	2-1/2	0	4-1/8	1-15/16	0.575	22.0	18.5
38	80Q38	Q1	12.670	12.110	4	2-11/16	2-25/32	2-1/2	0	4-1/8	1-15/16	0.575	23.5	20.0
39	80R39	R1	12.990	12.428	4	3-3/4	3-5/32	2-7/8	0	5-3/8	2-5/16	0.575	30.3	22.8
40	80Q40	Q1	13.310	12.746	4	2-11/16	2-25/32	2-1/2	0	4-1/8	1-15/16	0.575	25.4	21.9
40	80R40	R1	13.310	12.746	4	3-3/4	3-5/32	2-7/8	0	5-3/8	2-5/16	0.575	30.9	23.4
41	80R41	R1	13.630	13.064	4	3-3/4	3-5/32	2-7/8	0	5-3/8	2-5/16	0.575	31.4	23.9
42	80Q42	Q1	13.940	13.382	4	2-11/16	2-25/32	2-1/2	0	4-1/8	1-15/16	0.575	27.3	23.8
42	80R42	R1	13.940	13.382	4	3-3/4	3-5/32	2-7/8	0	5-3/8	2-5/16	0.575	32.9	25.4
44	80R44	R1	14.580	14.018	4	3-3/4	3-5/32	2-7/8	0	5-3/8	2-5/16	0.575	34.7	27.2
45	80Q45	Q1	14.900	14.336	4	2-11/16	2-25/32	2-1/2	0	4-1/8	1-15/16	0.575	31.3	27.8
45	80R45	R1	14.900	14.336	4	3-3/4	3-5/32	2-7/8	0	5-3/8	2-5/16	0.575	36.0	28.5
47	80R47	R1	15.540	14.972	4	3-3/4	3-5/32	2-7/8	0	5-3/8	2-5/16	0.575	38.5	31.0
48	80Q48	Q1	15.860	15.290	4	2-11/16	2-25/32	2-1/2	0	4-1/8	1-15/16	0.575	34.3	30.8
48	80R48	R1	15.860	15.290	4	3-3/4	3-5/32	2-7/8	0	5-3/8	2-5/16	0.575	39.8	32.3
50	80R50	R1	16.500	15.926	4	3-3/4	3-5/32	2-7/8	0	5-3/8	2-5/16	0.575	42.6	35.1
54	80Q54	Q1	17.770	17.198	4	2-11/16	2-25/32	2-1/2	0	4-1/8	1-15/16	0.575	42.0	38.5
54	80R54	R1	17.770	17.198	4	3-3/4	3-5/32	2-7/8	0	5-3/8	2-5/16	0.575	48.3	40.8
56	80R56	R1	18.410	17.835	4	3-3/4	3-5/32	2-7/8	0	5-3/8	2-5/16	0.575	51.5	44.0
60	80Q60	Q1	19.680	19.107	4	2-11/16	2-25/32	2-1/2	0	4-1/8	1-15/16	0.575	50.3	46.8
60	80R60	R1	19.680	19.107	4	3-3/4	3-5/32	2-7/8	0	5-3/8	2-5/16	0.575	54.8	47.3
70	80Q70	Q1	22.870	22.289	4	2-11/16	2-25/32	2-1/2	0	4-1/8	2-5/16	0.575	63.5	60.0
70	80R70	R1	22.870	22.289	4	3-3/4	3-5/32	2-7/8	0	5-3/8	2-5/16	0.575	71.0	63.5
72	80Q72	Q1	23.500	22.926	4	2-11/16	2-25/32	2-1/2	0	4-1/8	2-5/16	0.575	71.0	67.5
72	80R72	R1	23.500	22.926	5	3-3/4	3-5/32	2-7/8	1-7/16	5-3/8	7/8	0.575	76.9	69.4
80	80R80	R1	26.050	25.471	5	3-3/4	3-5/32	2-7/8	1-7/16	5-3/8	7/8	0.575	92.5	85.0
84	80R84	R1	27.330	26.744	5	3-3/4	3-5/32	2-7/8	1-7/16	5-3/8	7/8	0.575	97.5	90.0
96	80R96	R1	31.150	30.563	5	3-3/4	3-5/32	2-7/8	1-7/16	5-3/8	7/8	0.575	117.5	110.0
112	80S112	S1	36.240	36.655	5	4-1/4	4-3/4	4-3/8	2-3/4	6-3/8	1-1/8	0.575	178.5	165.0

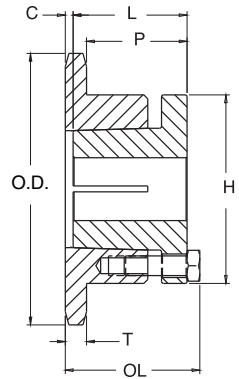

**TYPE 3**

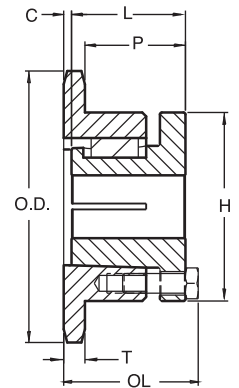

**TYPE 4**

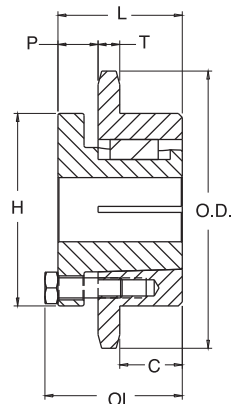

**TYPE 5**

Sprockets with "H" suffix have hardened teeth.

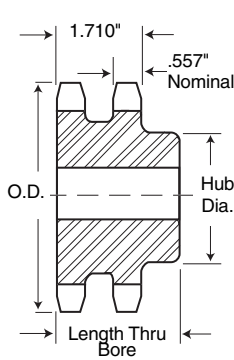

**TYPE B**



**TYPE C**



**QD — TYPE C<sub>1</sub>**



**QD — TYPE C<sub>3</sub>**

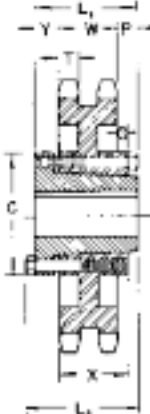

**QD — TYPE C<sub>4</sub>**

### Double - Type B & C

No. Teeth	Catalog Number	Outside Diameter	Type	Bore (inches)		Hub (inches)		Weight Lbs. (Approx.)
				Stock	Rec. Max.	Dia.	Length Thru	
10	D80B10H	3.680	B	1	1½	2½★	2½	3.6
11	D80B11H	4.010	B	1	1½	2½	2½	4.0
12	D80B12H	4.330	B	1	1½	2½	2½	5.1
13	D80B13H	4.660	B	1	2¼	3½	2½	6.3
14	D80B14H	4.980	B	1	2½	3½	2½	7.6
15	D80B15H	5.300	B	1	2½	3¾	2½	9.0
16	D80B16H	5.630	B	1	2¾	4	2½	11.0
17	D80B17H	5.950	B	1	3	4¾	2½	13.2
18	D80B18H	6.270	B	1	3¼	4¾	2½	15.0
19	D80B19H	6.590	B	1	3½	5	2½	17.0
20	D80B20H	6.910	B	1	3½	5	2½	18.2
21	D80B21H	7.240	B	1	3½	5	2½	19.6
22	D80B22H	7.560	B	1	3½	5	2½	21.0
23	D80B23H	7.880	B	1	3½	5	2½	22.8
24	D80B24H	8.200	B	1	3½	5½	2½	25.1
25	D80B25H	8.520	B	1	3½	5½	3	28.3
26	D80B26	8.840	B	1	3½	5½	3	29.9
30	D80B30	10.110	B	1½	3¾	5½	3	39.5
32	D80B32	10.750	B	1½	3¾	5½	3	43.8
35	D80B35	11.710	B	1½	3¾	5½	3	49.1
36	D80B36	12.030	B	1½	3¾	5½	3½	54.2
42	D80B42	13.940	B	1½	3¾	5½	3½	71.5
45	D80B45	14.900	B	1½	3¾	5½	3½	73.5
52	D80C52	17.130	C	1½	3¾	5½	3½	78.4
60	D80C60	19.680	C	1½	3¾	5½	3½	93.3
68	D80C68	22.230	C	1½	3¾	6	4	96.2
76	D80C76	24.780	C	1½	3¾	6	4	113.0
95	D80C95	30.830	C	1½	4	6	4½	165.0

★ Has recessed groove in hub for chain clearance.

Maximum bores shown will accommodate standard keyseat and setscrew over keyseat. Slightly larger bores are possible with no keyseat, shallow keyseat, or setscrew at angle to keyseat.

NOTE: Double 80 stock sprockets with 25 teeth or less have hardened teeth, as indicated by H suffix.

#### Alteration Charges

See current discount sheet for alteration charges.

### Double - Type QD

No. Teeth	Catalog Number	Bush-ing	Diameters		Type	Max. Bore	Dimensions										Weight Lbs. (Approx.)	
			Outside Diameter	Pitch Diameter			L <sub>1</sub>	L <sub>2</sub>	C	Y	P	G	V	X	T	W	With Hub	Rim Only
36	D80E36	E	12.030	11.474	C1	3½	2%	2½	6	5/64	1/8	—	—	1%	0.557	1.710	48.3	38.2
42	D80E42	E	13.940	13.382	C1	3½	2%	2½	6	5/64	1/8	—	—	1%	0.557	1.710	65.3	55.3
45	D80E45	E	14.900	14.336	C1	3½	2%	2½	6	5/64	1/8	—	—	1%	0.557	1.710	74.6	64.6
52	D80E52	E	17.130	16.562	C3	3½	2%	2½	6	5/64	1/8	—	3/32	1%	0.557	1.710	68.2	58.2
60	D80E60	E	19.680	19.107	C3	3½	2%	2½	6	5/64	1/8	—	3/32	1%	0.557	1.710	78.2	68.2
68	D80E68	E	22.230	21.653	C3	3½	2%	2½	6	5/64	1/8	—	3/32	1%	0.557	1.710	84.2	74.2
76	D80E76	E	24.780	24.198	C3	3½	2%	2½	6	5/64	1/8	—	3/32	1%	0.557	1.710	100.0	90.1
95	D80F95	F	30.830	30.245	C4	3½	3%	4	6%	1	59/64	5/64	—	2½	0.557	1.710	152.0	140.0

# No. 80-2 1" Pitch

## All Steel Stock Sprockets

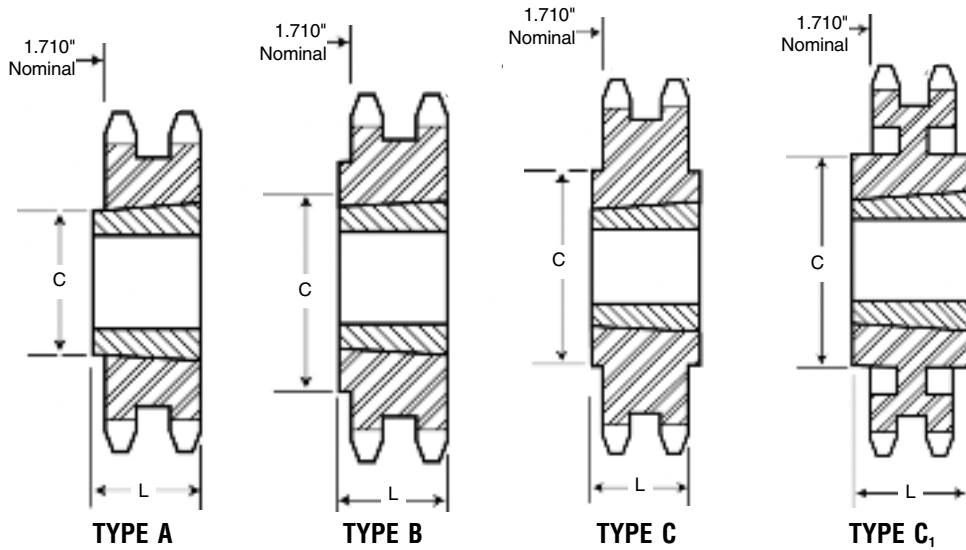

### Double - Taper Bushed

No. Teeth	Catalog Number	Bushing	Diameter		Max. Bore	Dimensions			Weight Lbs. (Approx.)	
			Outside Diameter	Pitch Diameter		L	C	Type	Rim Only	Bushing Only
13	D80ATB13H	1615	4.657	4.179	1 $\frac{1}{2}$	1 $\frac{1}{2}$	—	A	3.4	1.2
14	D80ATB14H	2012	4.982	4.494	2	1 $\frac{1}{4}$	—	A	3.5	1.7
15	D80ATB15H	2012	5.305	4.810	2	1 $\frac{1}{4}$	—	A	4.3	1.7
16	D80ATB16H	2517	5.627	5.126	2 $\frac{1}{2}$	1 $\frac{1}{4}$	3 $\frac{1}{2}$	A	3.8	3.5
17	D80ATB17H	2517	5.950	5.442	2 $\frac{1}{2}$	1 $\frac{1}{4}$	3 $\frac{1}{2}$	A	5.1	3.5
18	D80ATB18H	2517	6.271	5.759	2 $\frac{1}{2}$	1 $\frac{1}{4}$	3 $\frac{1}{2}$	A	6.4	3.5
19	D80BTB19H	3020	6.593	6.076	3	2	5	B	5.6	6.5
20	D80BTB20H	3020	6.914	6.392	3	2	5 $\frac{1}{2}$	B	7.1	6.5
21	D80BTB21H	3020	7.235	6.710	3	2	5 $\frac{5}{8}$	B	8.9	6.5
25	D80BTB25H	3020	8.516	7.979	3	2	6 $\frac{1}{2}$	B	16.5	6.5
30	D80CTB30	3020	10.114	9.567	3	2	5 $\frac{1}{4}$	C	25.1	6.5
36	D80CTB36	3020	12.030	11.474	3	2	5 $\frac{1}{2}$	C	39.4	6.5
42	D80CTB42	3020	13.944	13.392	3	2	5 $\frac{1}{2}$	C	36.4	6.5
45	D80CTB45	3020	14.901	14.336	3	2	5 $\frac{1}{4}$	C1	41.4	6.5
52	D80CTB52	3020	17.132	16.562	3	2	5 $\frac{1}{4}$	C1	56.2	6.5
60	D80CTB60	3020	19.681	19.107	3	2	5 $\frac{1}{2}$	C1	66.3	6.5
68	D80CTB68	3020	22.230	21.653	3	2	5 $\frac{1}{2}$	C1	72.0	6.5
76	D80CTB76	3020	24.778	24.198	3	2	5 $\frac{1}{2}$	C1	89.1	6.5
95	D80CTB95	3020	30.828	30.245	3	2	5 $\frac{1}{2}$	C1	112.0	6.5

NOTE: Double 80 stock sprockets with 25 teeth or less have hardened teeth, as indicated by H suffix.

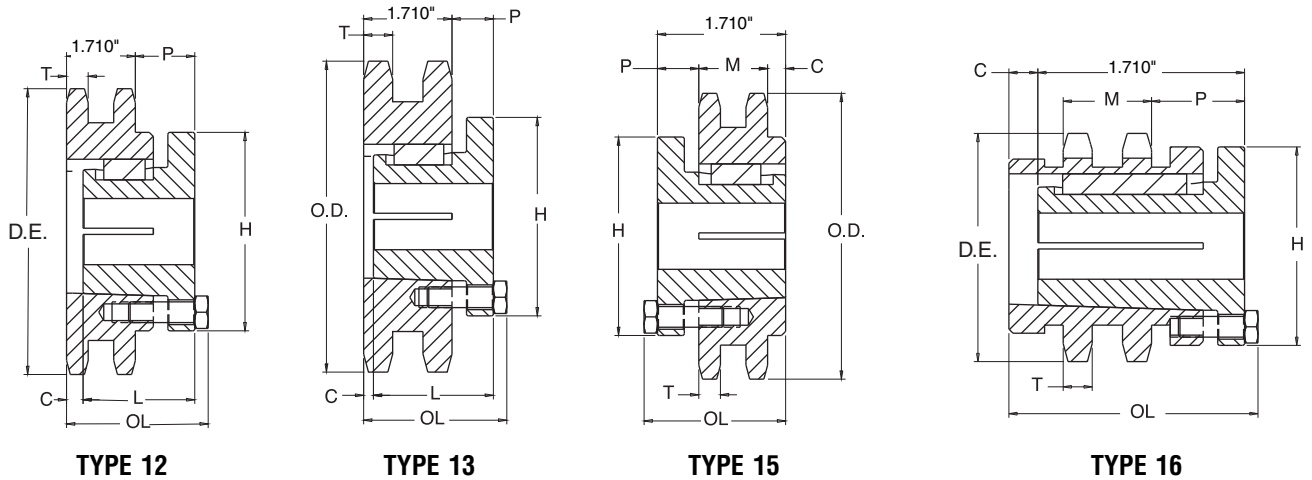

### Double - MST<sup>®</sup> Sprockets

No. Teeth	Catalog Number	Bush- ing	Diameters		Type	Max. Bore	Dimensions						Weight Lbs. (Approx.)	
			Outside Dia.	Pitch Dia.			OL	L	C	H	P	T(nom)	With Hub	Rim Only
13	D80P13H	P1	4.660	4.179	13	1-3/4	2-19/32	1-15/16	13/32	3	5/8	0.557	4.9	3.6
14	D80Q14H	Q2	4.980	4.494	16	2-5/8	4 5/8	3-1/2	27/32	4-1/8	1-3/4	0.557	9.9	5.4
15	D80Q15H	Q2	5.300	4.810	12	2-5/8	3-25/32	3-1/2	0	4-1/8	13/4	0.557	9.9	5.4
16	D80Q16H	Q1	5.630	5.126	13	2-11/16	2-25/32	2-1/2	0	4-1/8	3/4	0.557	8.3	4.8
17	D80Q17H	Q1	5.950	5.442	13	2-11/16	2-25/32	2-1/2	0	4-1/8	3/4	0.557	9.5	6.0
18	D80Q18H	Q1	6.270	5.759	13	2-11/16	2-25/32	2-1/2	0	4-1/8	3/4	0.557	10.8	7.3
19	D80Q19H	Q1	6.590	6.076	13	2-11/16	2-25/32	2-1/2	0	4-1/8	3/4	0.557	12.0	8.5
20	D80R20H	R1	6.910	6.392	12	3-3/4	3-5/32	2-7/8	0	5-3/8	1-5/32	0.557	15.3	7.8
21	D80R21H	R1	7.240	6.710	12	3-3/4	3-5/32	2-7/8	0	5-3/8	1-5/32	0.557	16.9	9.4
22	D80R22H	R1	7.560	7.027	12	3-3/4	3-5/32	2-7/8	0	5-3/8	1-5/32	0.557	18.3	10.8
23	D80R23H	R1	7.880	7.344	12	3-3/4	3-5/32	2-7/8	0	5-3/8	1-5/32	0.557	19.8	12.3
24	D80R24H	R1	8.200	7.661	12	3-3/4	3-5/32	2-7/8	0	5-3/8	1-5/32	0.557	21.6	14.1
25	D80R25H	R1	8.520	7.979	12	3-3/4	3-5/32	2-7/8	0	5-3/8	1-5/32	0.557	23.3	15.8
26	D80R26	R1	8.840	8.296	12	3-3/4	3-5/32	2-7/8	0	5-3/8	1-5/32	0.557	25.6	18.1
27	D80R27	R1	9.160	8.614	12	3-3/4	3-5/32	2-7/8	0	5-3/8	1-5/32	0.557	27.9	20.4
28	D80R28	R1	9.480	8.931	12	3-3/4	3-5/32	2-7/8	0	5-3/8	1-5/32	0.557	30.2	22.7
30	D80R30	R1	10.110	9.567	12	3-3/4	3-5/32	2-7/8	0	5-3/8	1-5/32	0.557	34.3	26.8
36	D80R36	R1	12.030	11.474	12	3-3/4	3-5/32	2-7/8	0	5-3/8	1-5/32	0.557	49.1	41.6
42	D80R42	R1	13.940	13.382	12	3-3/4	3-5/32	2-7/8	0	5-3/8	1-5/32	0.557	65.5	58.0
45	D80R45	R1	14.900	14.336	12	3-3/4	3-5/32	2-7/8	0	5-3/8	1-5/32	0.557	75.5	68.0
48	D80R48	R2	15.860	15.290	15	3-5/8	5-5/32	4-7/8	2-9/32	5-3/8	7/8	0.557	97.0	86.0
52	D80R52	R2	17.130	16.562	15	3-5/8	5-5/32	4-7/8	2-9/32	5-3/8	7/8	0.557	114.0	103.0
54	D80R54	R2	17.770	17.198	15	3-5/8	5-5/32	4-7/8	2-9/32	5-3/8	7/8	0.557	122.0	111.0
60	D80R60	R2	19.680	19.107	15	3-5/8	5-5/32	4-7/8	2-9/32	5-3/8	7/8	0.557	146.0	135.0
68	D80R68	R2	22.230	21.653	15	3-5/8	5-5/32	4-7/8	2-9/32	5-3/8	7/8	0.557	187.0	176.0
72	D80R72	R2	23.500	22.926	15	3-5/8	5-5/32	4-7/8	2-9/32	5-3/8	7/8	0.557	209.0	198.0
76	D80U76	U0	24.780	24.198	15	5-1/2	5-23/32	5-1/4	2-1/32	8-3/8	1-1/2	0.557	249.0	219.0
95	D80U95	U0	30.830	30.245	15	5 1/2	5-23/32	5-1/4	2-1/32	8-3/8	1-1/2	0.557	372.0	342.0

Sprockets with "H" suffix have hardened teeth.

# No. 80-3 1" Pitch

# All Steel Stock Sprockets

# Martin

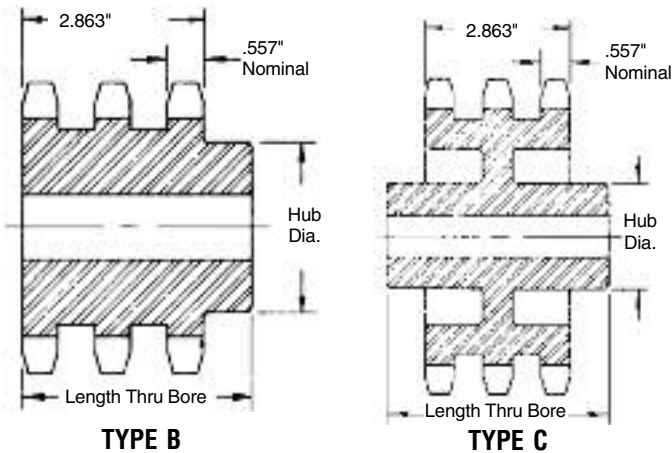

## Triple - Type B & C

No. Teeth	Catalog Number	Outside Diameter	Type	Bore (inches)		Hub (inches)		Weight Lbs. (Approx.)
				Stock	Rec. Max.	Dia.	Length Thru	
11	E80B11H	4.010	B	1	1 1/4	2 1/2	3 3/8	5.9
12	E80B12H	4.330	B	1	1 1/4	2 7/16	3 3/8	7.5
13	E80B13H	4.660	B	1	2 1/4	3 1/2	3 3/8	9.2
14	E80B14H	4.980	B	1	2 3/4	3 5/8	3 3/8	11.0
15	E80B15H	5.300	B	1	2 1/2	3 5/8	3 3/8	13.1
16	E80B16H	5.630	B	1	2 3/4	4	3 3/8	15.8
17	E80B17H	5.950	B	1	3	4 1/4	3 3/8	18.6
18	E80B18H	6.270	B	1	3 1/4	4 3/4	3 3/8	21.2
19	E80B19H	6.590	B	1	3 5/8	5	3 3/8	23.7
20	E80B20H	6.910	B	1	3 3/4	5	3 3/8	26.0
21	E80B21H	7.240	B	1	3 1/2	5	3 3/8	28.4
22	E80B22H	7.560	B	1	3 5/8	5	3 3/8	31.0
23	E80B23H	7.880	B	1	3 1/2	5	3 3/8	33.6
24	E80B24H	8.200	B	1	3 1/2	5 1/4	3 3/8	37.1
25	E80B25H	8.520	B	1	3 1/2	5 1/4	3 3/8	40.1
26	E80B26	8.840	B	1	3 1/2	5 1/4	3 3/8	42.9
30	E80B30	10.110	B	1 1/4	3 3/4	5 3/4	4 1/4	54.5
35	E80B35	11.710	B	1 1/4	3 3/4	5 3/4	4 1/4	79.5
36	E80B36	12.030	B	1 1/4	3 3/4	5 3/4	4 1/4	83.9
42	E80C42	13.940	C	1 1/4	3 3/4	6	4 1/2	84.9
45	E80C45	14.900	C	1 1/4	3 3/4	6	4 1/2	92.4
52	E80C52	17.130	C	1 1/2	4 1/4	6	4 1/2	107.0
60	E80C60	19.680	C	1 1/2	4 1/4	6 1/4	4 1/2	128.0
68	E80C68	22.230	C	1 1/2	4 1/4	6 1/4	4 1/2	140.0
76	E80C76	24.780	C	1 1/2	4 1/4	6 1/4	4 1/2	165.0
95	E80C95	30.830	C	1 1/2	4 1/4	6 1/4	5	240.0

Maximum bores shown will accommodate standard keyseat and setscrew over keyseat. Slightly larger bores are possible with no keyseat, shallow keyseat, or setscrew at angle to keyseat, as indicated by H suffix.

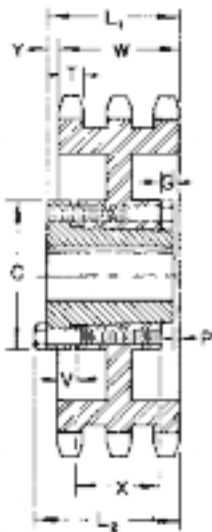

QD — TYPE B<sub>1</sub>



### Alteration Charges

See current discount sheet for alteration charges.

## Triple - Type QD

No. Teeth	Catalog Number	Bushing	Diameters		Type	Max. Bore	Dimensions										Weight Lbs. (Approx.)	
			Outside Diameter	Pitch Diameter			L <sub>1</sub>	L <sub>2</sub>	C	Y	P	G	V	X	T	W	With Hub	Rim Only
36	E80E36	E	12.030	11.474	B	3 1/2	3 3/4	3 7/8	6	1/4	3 1/4	1/2	5/8	1 1/8	0.557	2.863	65.1	55.1
42	E80E42	E	13.940	13.382	B	3 1/2	3 3/4	3 7/8	6	1/4	3 1/4	1/2	5/8	1 1/8	0.557	2.863	81.9	71.9
45	E80E45	E	14.900	14.336	B1	3 1/2	3 3/4	3 7/8	6	1/4	3 1/4	1/2	5/8	1 1/8	0.557	2.863	75.3	65.3
52	E80E52	E	17.130	16.562	B1	3 1/2	3 3/4	3 7/8	6	1/4	3 1/4	1/2	5/8	1 1/8	0.557	2.863	90.0	80.0
60	E80F60	F	19.680	19.107	B1	3 1/4	3 3/4	4 3/4	6 1/2	1 1/8	3/4	1/2	3/8	2 1/2	0.557	2.863	112.0	100.0
68	E80F68	F	22.230	21.653	B1	3 1/4	3 3/4	4 3/4	6 1/2	1 1/8	3/4	1/2	3/8	2 1/2	0.557	2.863	132.0	120.0
76	E80F76	F	24.780	24.198	B1	3 1/4	3 3/4	4 3/4	6 1/2	1 1/8	3/4	1/2	3/8	2 1/2	0.557	2.863	150.0	138.0
95	E80F95	F	30.830	30.245	B1	3 1/4	3 3/4	4 3/4	6 1/2	1 1/8	3/4	1/2	3/8	2 1/2	0.557	2.863	208.0	196.0

NOTE: Triple 80 stock sprockets with 25 teeth or less have hardened teeth.



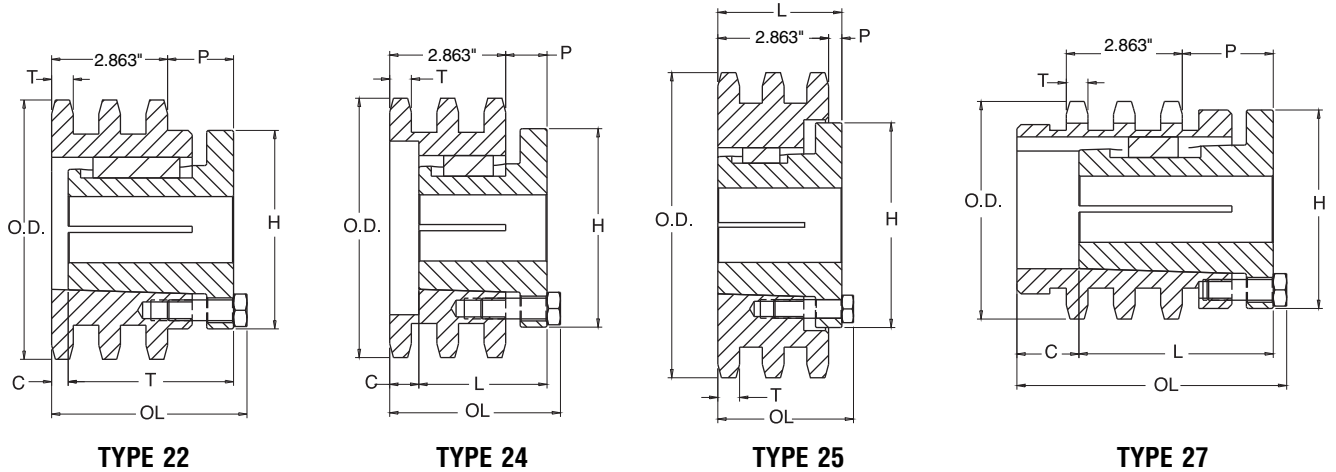

## Triple - MST® Sprockets

No. Teeth	Catalog Number	Bush-ing	Diameters		Type	Max. Bore	Dimensions						Weight Lbs. (Approx.)	
			Outside Dia.	Pitch Dia.			OL	L	C	H	P	T(nom)	With Hub	Rim Only
13	E80P13H	P2	4.660	4.179	24	1-3/4	3-3/4	2-15/16	9/16	3	5/8	0.557	7.2	5.7
14	E80Q14H	Q2	4.980	4.494	27	2-5/8	5-25/32	3-1/2	2	4-1/8	1-3/4	0.557	12.0	7.5
15	E80Q15H	Q2	5.300	4.810	22	2-5/8	4-29/32	3-1/2	1-1/8	4-1/8	1-3/4	0.557	12.6	8.1
16	E80Q16H	Q2	5.630	5.126	25	2-5/8	3-7/8	3-1/2	3/32	4-1/8	3/4	0.557	13.8	9.3
17	E80Q17H	Q2	5.950	5.442	24	2-5/8	3-29/32	3-1/2	1/8	4-1/8	3/4	0.557	14.3	9.8
18	E80Q18H	Q2	6.270	5.759	24	2-5/8	3-29/32	3-1/2	1/8	4-1/8	3/4	0.557	16.5	12.0
19	E80Q19H	Q2	6.590	6.076	24	2-5/8	3-29/32	3-1/2	1/8	4-1/8	3/4	0.557	18.4	13.9
20	E80R20H	R1	6.910	6.392	24	3-3/4	4-1/32	2-7/8	7/8	5-3/8	7/8	0.557	17.7	10.2
21	E80R21H	R1	7.240	6.710	24	3-3/4	4-1/32	2-7/8	7/8	5-3/8	7/8	0.557	19.9	12.4
22	E80R22H	R1	7.560	7.027	24	3-3/4	4-1/32	2-7/8	7/8	5-3/8	7/8	0.557	22.1	14.6
23	E80R23H	R1	7.880	7.344	25	3-3/4	3-5/32	2-7/8	0	5-3/8	0	0.557	23.4	15.9
24	E80R24	R1	8.200	7.661	25	3-3/4	3-5/32	2-7/8	0	5-3/8	0	0.557	7.2	18.5
25	E80R25	R1	8.520	7.979	25	3-3/4	3-5/32	2-7/8	0	5-3/8	0	0.557	12.0	20.3
26	E80R26	R1	8.840	8.296	25	3-3/4	3-5/32	2-7/8	0	5-3/8	0	0.557	12.6	23.4
27	E80R27	R1	9.160	8.614	25	3-3/4	3-5/32	2-7/8	0	5-3/8	0	0.557	13.8	25.8
28	E80R28	R1	9.480	8.931	25	3-3/4	3-5/32	2-7/8	0	5-3/8	0	0.557	14.3	28.1
30	E80R30	R1	10.110	9.567	25	3-3/4	3-5/32	2-7/8	0	5-3/8	0	0.557	16.5	33.3
36	E80S36	S1	12.030	11.474	22	4-1/4	5-1/8	4-3/8	0	6-3/8	1-1/2	0.557	18.4	67.0
42	E80S42	S1	13.940	13.382	22	4-1/4	5-1/8	4-3/8	0	6-3/8	1-1/2	0.557	17.7	96.1
45	E80S45	S1	14.900	14.336	22	4-1/4	5-1/8	4-3/8	0	6-3/8	1-1/2	0.557	19.9	112.0
52	E80U52	U0	17.130	16.562	22	5-1/2	5-23/32	5-1/4	0	8-3/8	1-25/32	0.557	22.1	150.0
60	E80U60	U0	19.680	19.107	22	5-1/2	5-23/32	5-1/4	0	8-3/8	1-25/32	0.557	23.4	207.0
68	E80U68	U0	22.230	21.653	22	5-1/2	5-23/32	5-1/4	0	8-3/8	1-25/32	0.557	23.4	271.0
76	E80U76	U0	24.780	24.198	22	5-1/2	5-23/32	5-1/4	0	8-3/8	1-25/32	0.557	23.4	344.0
95	E80U95	U0	30.830	30.245	25	5-1/2	5-55/64	5-1/4	1/32	8-3/8	1-13/32	0.557	23.4	183.0

Sprockets with "H" suffix have hardened teeth.

# No. 100

## 1 1/4" Pitch

# All Steel Stock Sprockets

# Martin



**BORED-TO-SIZE**

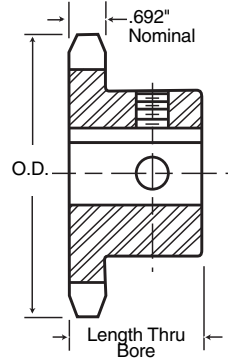

**TYPE BS**

### Single - Type BS — 2 Setscrews — Bored-To-Size

No. Teeth	Catalog Number	Outside Diameter	Length Thru Bore	Weight Lbs. (Approx.)	Stock Finished Bores Includes Keyway and Setscrews
8	100BS8	3.770	1 1/8	2.8	1 — 1 1/8 — 1 1/4
9	100BS9	4.180	1 1/8	3.0	1 — 1 1/8 — 1 1/4 — 1 1/16
10	100BS10	4.600	1 1/8	3.9	1 — 1 1/8 — 1 1/4 — 1 1/16
11	100BS11	5.010	1 1/8	4.9	1 — 1 1/8 — 1 1/4 — 1 1/16 — 1 1/16 — 2 — 2 3/16
12	100BS12	5.420	1 1/8	6.0	1 — 1 1/8 — 1 1/4 — 1 1/16 — 1 1/16 — 2 — 2 3/16
13	100BS13	5.820	1 3/8	6.2	1 — 1 3/8 — 1 1/2 — 1 1/16 — 1 1/16 — 2 — 2 3/16
14	100BS14	6.230	1 3/8	6.6	— 1 1/2 — 1 1/16 — 1 1/16 — 2 — 2 3/16
15	100BS15	6.630	1 3/8	8.4	— 1 1/2 — 1 1/16 — 1 1/16 — 2 — 2 3/16
16	100BS16	7.030	1 3/8	9.0	— 1 1/2 — 1 1/16 — 1 1/16 — 2 — 2 3/16 — 2 7/16 — 2 5/16
17	100BS17	7.440	1 3/8	9.9	— 1 1/2 — 1 1/16 — 1 1/16 — 2 — 2 3/16 — 2 7/16 — 2 5/16
18	100BS18	7.840	1 3/4	10.6	— 1 1/2 — 1 1/16 — 1 1/16 — 2 — 2 3/16 — 2 7/16 — 2 5/16
19	100BS19	8.240	2	12.1	— 1 1/2 — 1 1/16 — 1 1/16 — 2 — 2 3/16 — 2 7/16 — 2 5/16
20	100BS20	8.640	2	13.2	— 1 1/2 — 1 1/16 — 1 1/16 — 2 — 2 3/16 — 2 7/16 — 2 5/16
21	100BS21	9.040	2	14.3	— 1 1/2 — 1 1/16 — 1 1/16 — 2 — 2 3/16 — 2 7/16 — 2 5/16
22	100BS22	9.440	2	15.1	— 1 1/2 — 1 1/16 — 1 1/16 — 2 — 2 3/16 — 2 7/16 — 2 5/16
23	100BS23	9.840	2	16.1	— 1 1/2 — 1 1/16 — 1 1/16 — 2 — 2 3/16 — 2 7/16 — 2 5/16
24	100BS24	10.250	2	18.1	— 1 1/2 — 1 1/16 — 1 1/16 — 2 — 2 3/16 — 2 7/16 — 2 5/16
25	100BS25	10.650	2	18.4	— 1 1/2 — 1 1/16 — 1 1/16 — 2 — 2 3/16 — 2 7/16 — 2 5/16

Hub diameters vary to suit different bore sizes.

NOTE: KEYWAY IS ON CENTER LINE OF TOOTH.

### Single - Type C — Steel

No. Teeth	Catalog Number	Outside Diameter	Bore (inches)		Hub (inches)		Weight Lbs. (Approx.)
			Stock	Rec. Max.	Diameter	Length	
10	100C10	4.600	1	1 1/8	3 5/16	2 1/8	6.13
11	100C11	5.010	1	2 1/4	3 3/8	2 1/8	7.12
12	100C12	5.420	1	2 1/16	4	2 1/8	8.37
13	100C13	5.820	1	2 3/8	3 7/16	2 1/8	10.00
14	100C14	6.230	1	2 3/4	4 1/8	2 1/8	12.19

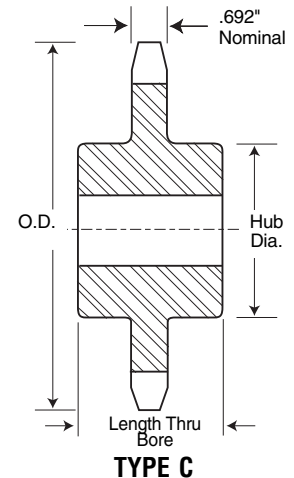

**TYPE C**

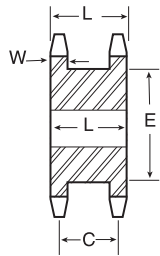

**TYPE A**

### Double Single - Type A — Steel

No. Teeth	Catalog Number	Diameters		Type	Min. Bore	Max. Bore	Dimensions				Wt. Lbs. (Approx.)
		Outside Diameter	Pitch Diameter				L	C	E	w Nom.	
13	DS100A13	5.820	5.223	A	1	2 1/2	2 1/16	2	3 5/32	0.692	11.2
14	DS100A14	6.230	5.617	A	1 1/4	2 1/2	2 1/16	2	4 1/16	0.692	13.5
15	DS100A15	6.630	6.012	A	1 1/4	3 1/16	2 1/16	2	4 1/32	0.692	16.8
16	DS100A16	7.030	6.407	A	1 1/4	3 1/2	2 1/16	2	5	0.692	19.3
17	DS100A17	7.440	6.803	A	1 1/4	3 3/8	2 1/16	2	5 1/32	0.692	21.5
18	DS100A18	7.840	7.198	A	1 1/2	3 1/2	2 1/16	2	5 5/64	0.692	23.0
19	DS100A19	8.240	7.595	A	1 1/2	4 1/16	2 1/16	2	6 1/64	0.692	25.0
20	DS100A20	8.640	7.991	A	1 1/2	4 1/8	2 1/16	2	6 3/64	0.692	26.5
21	DS100A21	9.040	8.387	A	1 1/2	5	2 1/16	2	7	0.692	29.0

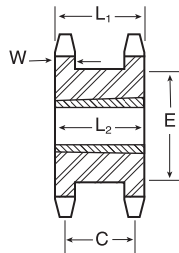

**TAPER BUSH  
TYPE A**

### Double Single - Taper Bushed — Steel

No. Teeth	Catalog Number	Bushing Size	Diameters		Min. Bore	Max. Bore	Type	Dimensions				Wt. Rim Only	
			Outside Diameter	Pitch Diameter				L <sub>1</sub>	C	E	L <sub>2</sub>		w Nom.
15	DS100ATB15H	2517	6.630	6.012	3/4	2 1/2	A	2 1/16	2	4 19/32	1 1/4	0.692	12.5
16	DS100ATB16H	2517	7.030	6.407	3/4	2 1/2	A	2 1/16	2	5	1 1/4	0.692	13.0
17	DS100ATB17H	3020	7.440	6.803	1 1/16	3	A	2 1/16	2	5 13/32	2	0.692	14.0
18	DS100ATB18H	3020	7.840	7.198	1 1/16	3	A	2 1/16	2	5 51/64	2	0.692	16.0
19	DS100ATB19H	3020	8.240	7.595	1 1/16	3	A	2 1/16	2	6 13/64	2	0.692	20.0
20	DS100ATB20H	3020	8.640	7.991	1 1/16	3	A	2 1/16	2	6 39/64	1 1/4	0.692	27.5
21	DS100ATB21H	3020	9.040	8.387	1 1/16	3	A	2 1/16	2	7	2	0.692	27.5

Sprockets with "H" suffix have hardened teeth.

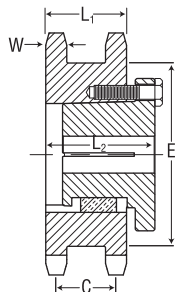

**MST  
TYPE B**

### Double Single - MST® — Steel

No. Teeth	Catalog Number	Bushing Size	Diameters		Min. Bore	Max. Bore	Type	Dimensions				Wt. Rim Only	
			Outside Diameter	Pitch Diameter				L <sub>1</sub>	C	E	L <sub>2</sub>		w Nom.
17	DS100R17H	R1	7.440	6.803	1 1/8	3 3/8	B	2 1/16	2	5 13/32	3 27/32	0.692	12.5
19	DS100R19H	R1	8.240	7.595	1 1/8	3 3/8	B	2 1/16	2	6 13/64	3 27/32	0.692	18.8
21	DS100R21H	R1	9.040	8.387	1 1/8	3 3/8	B	2 1/16	2	7	3 27/32	0.692	23.1

Sprockets with "H" suffix have hardened teeth.

# No. 100 1 1/4" Pitch

# Stainless Steel Stock Sprockets

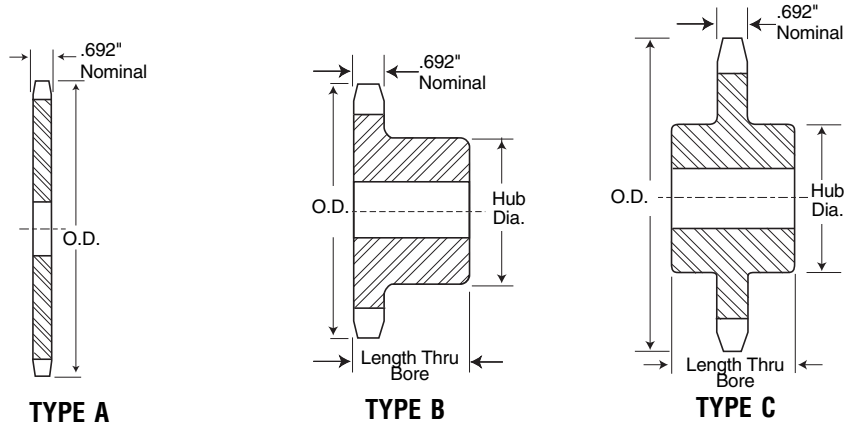

## Single - Type B & C

## Single - Type A

No. Teeth	Catalog Number	Outside Diameter	Type	Bore (inches)		Hub (inches)		Weight Lbs. (Approx.)	Type	Catalog Number	Stock Bore	Weight Lbs. (Approx.)
				Stock	Rec. Max.	Diameter	Length Thru					
11	100B11SS	5.010	B	1	2 1/4	3 5/8 ★	1 1/8	5.3	-	-	-	-
12	100B12SS	5.420	B	1	2 1/4	4 ★	1 1/8	6.4	-	-	-	-
13	100B13SS	5.820	B	1	2 3/8	3 3/8	1 1/8	6.6	-	-	-	-
14	100B14SS	6.230	B	1 1/4	2 3/8	4 3/8	1 1/8	7.4	-	-	-	-
15	100B15SS	6.630	B	1 1/4	3	4 1/2	1 1/8	9.2	-	-	-	-
16	100B16SS	7.030	B	1 1/8	3	4 1/2	1 1/8	9.9	A	100A16SS	1 1/4	5.4
17	100B17SS	7.440	B	1 1/8	3	4 1/2	1 1/8	10.8	A	100A17SS	1 1/4	6.1
18	100B18SS	7.840	B	1 1/8	3	4 1/2	1 1/8	11.5	A	100A18SS	1 1/4	7.0
19	100B19SS	8.240	B	1 1/8	3	4 1/2	2	13.1	A	100A19SS	1 1/4	7.8
20	100B20SS	8.640	B	1 1/8	3	4 1/2	2	14.2	A	100A20SS	1 1/4	8.8
21	100B21SS	9.040	B	1 1/8	3	4 1/2	2	15.3	A	100A21SS	1 1/4	9.8

★ Has recessed groove in hub for chain clearance.

Maximum bores shown will accommodate standard keyseat and setscrew over keyseat. Slightly larger bores are possible with no keyseat, shallow keyseat, or setscrew at angle to keyseat.

### Alteration Charges

See current discount sheet for alteration charges.

### Single - Type B & C

### Single-Type A

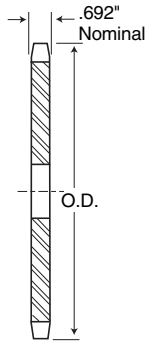

**TYPE A**

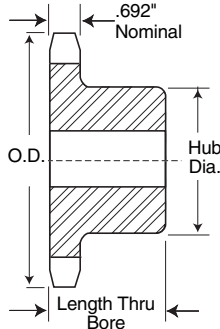

**TYPE B**

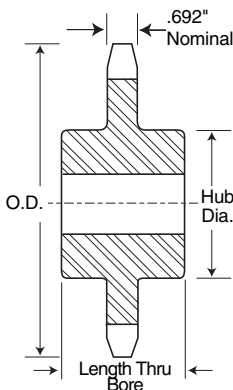

**TYPE C**

**Alteration Charges**

See current discount sheet for alteration charges.

No. Teeth	Catalog Number	Outside Diameter	Type	Bore (inches)		Hub (inches)		Weight Lbs. (Approx.)	Type	Catalog Number	Stock Bore	Weight Lbs. (Approx.)
				Stock	Rec. Max.	Diameter	Length Thru					
7		3.350							A	100A7	1	1.2
8	100B8	3.770	B	1	1 1/4	2 5/16 ★	1 1/4	2.3	A	100A8	1	1.4
9	100B9	4.180	B	1	1 1/4	2 9/16 ★	1 1/4	3.2	A	100A9	1	1.6
10	100B10	4.600	B	1	1 1/4	3 1/4 ★	1 1/4	4.1	A	100A10	1	2.0
11	100B11	5.010	B	1	2 1/4	3 5/16 ★	1 1/4	5.3	A	100A11	1 1/4	2.5
12	100B12	5.420	B	1	2 1/4	4 ★	1 1/4	6.4	A	100A12	1 1/4	3.0
13	100B13	5.820	B	1	2 1/4	3 3/4	1 1/4	6.6	A	100A13	1 1/4	3.5
14	100B14	6.230	B	1 1/4	2 1/4	4 1/16	1 1/4	7.4	A	100A14	1 1/4	4.1
15	100B15	6.630	B	1 1/4	3	4 1/2	1 1/4	9.2	A	100A15	1 1/4	4.7
16	100B16	7.030	B	1 5/16	3	4 1/2	1 1/4	9.9	A	100A16	1 1/4	5.4
17	100B17	7.440	B	1 5/16	3	4 1/2	1 1/4	10.8	A	100A17	1 1/4	6.1
18	100B18	7.840	B	1 5/16	3	4 1/2	1 1/4	11.5	A	100A18	1 1/4	7.0
19	100B19	8.240	B	1 5/16	3	4 1/2	2	13.1	A	100A19	1 1/4	7.8
20	100B20	8.640	B	1 5/16	3	4 1/2	2	14.2	A	100A20	1 1/4	8.8
21	100B21	9.040	B	1 5/16	3	4 1/2	2	15.3	A	100A21	1 1/4	9.8
22	100B22	9.440	B	1 5/16	3	4 1/2	2	16.1	A	100A22	1 1/4	10.5
23	100B23	9.840	B	1 1/2	3	4 1/2	2	17.2	A	100A23	1 1/4	11.8
24	100B24	10.250	B	1 1/2	3	4 1/2	2	19.2	A	100A24	1 1/4	12.8
25	100B25	10.650	B	1 1/2	3	4 1/2	2	19.5	A	100A25	1 1/4	13.9
26	100B26	11.050	B	1 1/2	3 5/16	5	2	21.7	A	100A26	1 1/4	15.0
27	100B27	11.440	B	1 1/2	3 5/16	5	2	23.0	A	100A27	1 1/4	16.0
28	100B28	11.840	B	1 1/2	3 5/16	5	2	24.4	A	100A28	1 1/4	17.4
29	100B29	12.240	B	1 1/2	3 5/16	5	2	25.0	A	100A29	1 1/4	19.6
30	100B30	12.640	B	1 1/2	3 5/16	5	2	26.9	A	100A30	1 1/4	20.1
31		13.040							A	100A31	1 1/4	21.5
32	100B32	13.440	B	1 1/2	3 5/16	5	2	29.8	A	100A32	1 1/4	22.6
33		13.840							A	100A33	1 1/4	24.1
34		14.240							A	100A34	1 1/4	26.0
35	100B35	14.640	B	1 1/2	3 5/16	5	2 1/2	36.9	A	100A35	1 1/4	27.2
36	100B36	15.040	B	1 1/2	3 5/16	5	2 1/2	38.6	A	100A36	1 1/4	30.0
37		15.440							A	100A37	1 1/4	31.0
38	100B38	15.840	B	1 1/2	3 5/16	5	2 1/2	41.5	A	100A38	1 1/4	33.0
39	100B39	16.230	B	1 1/2	3 5/16	5	2 1/2	43.6	A	100A39	1 1/4	35.0
40	100B40	16.630	B	1 1/2	3 5/16	5	2 1/2	46.9	A	100A40	1 1/4	36.0
41		17.030							A	100A41	1 1/4	39.0
42	100B42	17.430	B	1 1/2	3 5/16	5	2 1/2	50.4	A	100A42	1 1/4	40.0
43		17.830							A	100A43	1 1/2	43.0
44		18.230							A	100A44	1 1/2	45.0
45	100B45	18.630	B	1 1/2	3 5/16	5	2 1/2	54.0	A	100A45	1 1/2	47.0
46		19.020							A	100A46	1 1/2	48.0
47		19.420							A	100A47	1 1/2	52.0
48	100B48	19.820	B	1 1/2	4	6	2 1/2	66.0	A	100A48	1 1/2	54.0
49		20.220							A	100A49	1 1/2	56.0
50		20.620							A	100A50	1 1/2	57.0
51		21.020							A	100A51	1 1/2	63.0
52		21.420							A	100A52	1 1/2	64.0
53		21.810							A	100A53	1 1/2	64.2
54	100C54	22.210	C	1 1/2	4	6	3 1/4	78.0	A	100A54	1 1/2	68.0
55		22.610							A	100A55	1 1/2	70.0
56		23.010							A	100A56	1 1/2	72.0
57		23.410							A	100A57	1 1/2	75.8
58		23.810							A	100A58	1 1/2	76.0
59		24.200							A	100A59	1 1/2	77.0
60	100C60	24.600	C	1 1/2	4	6	3 3/4	89.0	A	100A60	1 1/2	80.0
70	100C70	28.580	C	1 1/2	5 1/4	7	3 3/4	125.0	A	100A70	1 1/2	113
72	100C72	29.380	C	1 1/2	5 1/4	7	3 3/4	134.0	A	100A72	1 1/2	119
76	100C76	30.973	C	1 1/2	5 1/4	7	3 3/4	143.0	A	100A76	1 1/2	133
80	100C80	32.570	C	1 1/2	5 1/4	7	3 3/4	151.0	A	100A80	1 1/2	146
84	100C84	34.160	C	1 1/2	5 1/4	7	3 3/4	170.0	A	100A84	1 1/2	162
90	100C90	36.550	C	1 1/2	5 1/4	7	3 3/4	184.0	A	100A90	1 1/2	193
96	100C96	38.930	C	1 1/2	5 1/4	7	4 1/4	203.0	A	100A96	1 1/2	215

★ Has recessed groove in hub for chain clearance.

Maximum bores shown will accommodate standard keyseat and setscrew over keyseat. Slightly larger bores are possible with no keyseat, shallow keyseat, or setscrew at angle to keyseat.

# No. 100

## 1 1/4" Pitch

# All Steel Stock Sprockets

# Martin

### Single - Type QD With Hardened Teeth

No. Teeth	Catalog Number
11	100SDS11H
12	100SDS12H
13	100SK13H
14	100SK14H
15	100SF15H
16	100SF16H
17	100SF17H
18	100E18H
19	100E19H
20	100E20H
21	100E21H
22	100E22H
23	100E23H
24	100E24H
25	100E25H
26	100E26H
27	100E27H
28	100E28H
30	100E30H

**SABER  
TOOTH®**

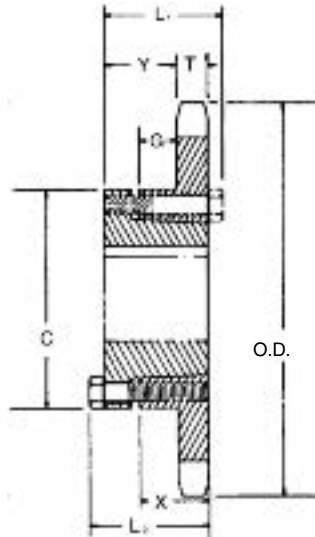

QD — TYPE B

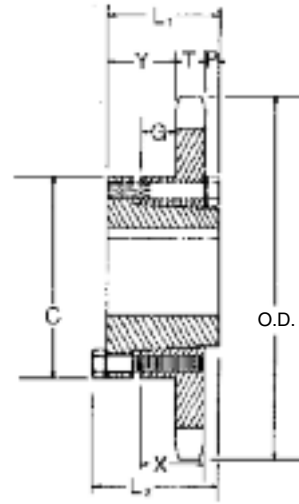

QD — TYPE B<sub>1</sub>

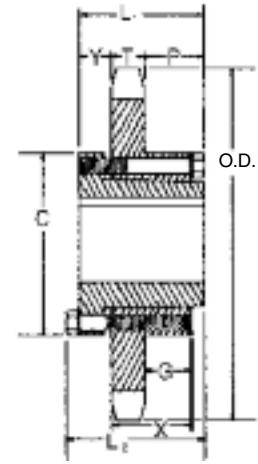

QD — TYPE C

### Single - Type QD

No. Teeth	Catalog Number	Bush-ing	Diameters		Type	Max. Bore	Dimensions								Weight Lbs. (Approx.)	
			Outside Diameter	Pitch Diameter			L <sub>1</sub>	L <sub>2</sub>	C	Y	P	G	X	T	With Hub	Rim Only
11	100SDS11	SDS	5.010	4.437	B	2	1 1/2	1 1/2	3 5/16	5/8	—	1/16	3/4	0.692	3.0	2.0
12	100SDS12	SDS	5.420	4.830	B	2	1 1/2	1 1/2	3 3/16	5/8	—	1/16	3/4	0.692	3.6	2.6
13	100SK13	SK	5.820	5.223	B	2 1/2	2 1/2	2 1/2	3 3/8	1 1/4	—	3/16	1 1/4	0.692	5.3	3.3
14	100SK14	SK	6.230	5.617	B	2 1/2	2 1/2	2 1/2	3 3/8	1 1/4	—	3/16	1 1/4	0.692	6.1	4.1
15	100SF15	SF	6.630	6.012	B	2 1/2	2 1/2	2 1/2	4 1/8	1 1/4	—	3/16	1 1/4	0.692	7.8	4.8
16	100SF16	SF	7.030	6.407	B	2 1/2	2 1/2	2 1/2	4 1/8	1 1/4	—	3/16	1 1/4	0.692	8.6	5.6
17	100SF17	SF	7.440	6.803	B	2 1/2	2 1/2	2 1/2	4 1/8	1 1/4	—	3/16	1 1/4	0.692	9.5	6.5
18	100E18	E	7.840	7.198	B1	3 1/2	2 1/2	2 1/2	6	1 1/2	1/8	1/16	1 1/2	0.692	19.0	9.0
19	100E19	E	8.240	7.595	B1	3 1/2	2 1/2	2 1/2	6	1 1/2	1/8	1/16	1 1/2	0.692	20.2	10.2
20	100E20	E	8.640	7.991	B1	3 1/2	2 1/2	2 1/2	6	1 1/2	1/8	1/16	1 1/2	0.692	21.6	11.6
21	100E21	E	9.040	8.387	B1	3 1/2	2 1/2	2 1/2	6	1 1/2	1/8	1/16	1 1/2	0.692	22.5	12.5
22	100E22	E	9.440	8.783	B1	3 1/2	2 1/2	2 1/2	6	1 1/2	1/8	1/16	1 1/2	0.692	23.5	13.5
23	100E23	E	9.840	9.180	B1	3 1/2	2 1/2	2 1/2	6	1 1/2	1/8	1/16	1 1/2	0.692	24.6	14.6
24	100E24	E	10.250	9.577	B1	3 1/2	2 1/2	2 1/2	6	1 1/2	1/8	1/16	1 1/2	0.692	25.7	15.7
25	100E25	E	10.650	9.973	B1	3 1/2	2 1/2	2 1/2	6	1 1/2	1/8	1/16	1 1/2	0.692	26.8	16.8
26	100E26	E	11.050	10.370	B1	3 1/2	2 1/2	2 1/2	6	1 1/2	1/8	1/16	1 1/2	0.692	28.1	18.1
27	100E27	E	11.440	10.767	B1	3 1/2	2 1/2	2 1/2	6	1 1/2	1/8	1/16	1 1/2	0.692	29.2	19.2
28	100E28	E	11.840	11.164	B1	3 1/2	2 1/2	2 1/2	6	1 1/2	1/8	1/16	1 1/2	0.692	30.7	20.7
30	100E30	E	12.640	11.958	B1	3 1/2	2 1/2	2 1/2	6	1 1/2	1/8	1/16	1 1/2	0.692	33.2	23.2
32	100E32	E	13.440	12.753	B1	3 1/2	2 1/2	2 1/2	6	1 1/2	1/8	1/16	1 1/2	0.692	35.4	25.4
35	100E35	E	14.640	13.945	B1	3 1/2	2 1/2	2 1/2	6	1 1/2	1/8	1/16	1 1/2	0.692	40.5	30.5
36	100E36	E	15.040	14.342	B1	3 1/2	2 1/2	2 1/2	6	1 1/2	1/8	1/16	1 1/2	0.692	42.5	32.3
40	100E40	E	16.630	15.932	B1	3 1/2	2 1/2	2 1/2	6	1 1/2	1/8	1/16	1 1/2	0.692	49.1	39.1
42	100E42	E	17.430	16.727	B1	3 1/2	2 1/2	2 1/2	6	1 1/2	1/8	1/16	1 1/2	0.692	53.4	43.4
45	100E45	E	18.630	17.920	B1	3 1/2	2 1/2	2 1/2	6	1 1/2	1/8	1/16	1 1/2	0.692	58.9	48.9
48	100E48	E	19.820	19.112	B1	3 1/2	2 1/2	2 1/2	6	1 1/2	1/8	1/16	1 1/2	0.692	64.0	54.0
54	100E54	E	22.210	21.498	C	3 1/2	2 1/2	2 1/2	6	7/8	1 1/8	1/16	1 1/2	0.692	72.0	62.0
60	100E60	E	24.600	23.884	C	3 1/2	2 1/2	2 1/2	6	7/8	1 1/8	1/16	1 1/2	0.692	84.0	74.0
70	100F70	F	28.580	27.862	C	3 1/2	3 1/2	4	6 1/2	1	1 1/8	1 1/16	2 1/2	0.692	110.5	99.0
72	100F72	F	29.380	28.657	C	3 1/2	3 1/2	4	6 1/2	1	1 1/8	1 1/16	2 1/2	0.692	117.5	106.0
80	100F80	F	32.570	31.839	C	3 1/2	3 1/2	4	6 1/2	1	1 1/8	1 1/16	2 1/2	0.692	134.5	123.0
84	100F84	F	34.160	33.430	C	3 1/2	3 1/2	4	6 1/2	1	1 1/8	1 1/16	2 1/2	0.692	151.5	140.0

### Single - Taper Bushed with Hardened Teeth



**SABER  
TOOTH®**

No. Teeth	Catalog Number
11	100BTB11H
12	100BTB12H
13	100BTB13H
14	100BTB14H
15	100BTB15H
16	100BTB16H
17	100BTB17H
18	100BTB18H
19	100BTB19H
20	100BTB20H
21	100BTB21H
22	100BTB22H
24	100BTB24H
26	100BTB26H
28	100BTB28H
30	100BTB30H

### Single - Taper Bushed

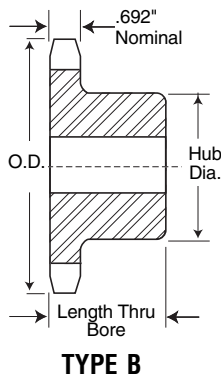

No. Teeth	Catalog Number	Bushing	Diameter		Max. Bore	Dimensions		Type	Weight Lbs. (Approx.)	
			Outside Diameter	Pitch Diameter		L	C		Rim Only	Bushing Only
11	100BTB11	1615	5.007	4.437	1½	1½	3	B	2.7	1.2
12	100BTB12	1615	5.415	4.830	1½	1½	3¼	B	3.5	1.2
13	100BTB13	2012	5.821	5.223	2	1¼	3⅝	B	3.6	1.7
14	100BTB14	2012	6.227	5.617	2	1¼	3⅝	B	3.9	1.7
15	100BTB15	2517	6.631	6.012	2½	1¼	4¼	B	5.0	3.5
16	100BTB16	2517	7.034	6.407	2½	1¼	4½	B	6.4	3.5
17	100BTB17	2517	7.437	6.803	2½	1¼	4½	B	7.1	3.5
18	100BTB18	2517	7.839	7.198	2½	1¼	4½	B	7.8	3.5
19	100BTB19	2517	8.241	7.594	2½	1¼	4½	B	8.7	3.5
20	100BTB20	2517	8.642	7.991	2½	1¼	4½	B	9.6	3.5
21	100BTB21	2517	9.043	8.387	2½	1¼	4½	B	10.6	3.5
22	100BTB22	2517	9.444	8.783	2½	1¼	4½	B	11.0	3.5
24	100BTB24	2517	10.245	9.577	2½	1¼	4½	B	13.0	3.5
26	100BTB26	2517	11.045	10.370	2½	1¼	4½	B	15.0	3.5
28	100BTB28	3020	11.844	11.164	3	2	5¼	B	16.5	6.5
30	100BTB30	3020	12.643	11.958	3	2	5¼	B	22.0	6.5
32	100BTB32	3020	13.442	12.753	3	2	5¼	B	23.0	6.5
35	100BTB35	3020	14.639	13.945	3	2	5¼	B	28.0	6.5
36	100BTB36	3020	15.038	14.342	3	2	5¼	B	31.0	6.5
40	100BTB40	3020	16.633	15.932	3	2	5¼	B	37.0	6.5
45	100BTB45	3020	18.626	17.919	3	2	5¼	B	46.0	6.5
48	100BTB48	3020	19.821	19.112	3	2	5¼	B	53.0	6.5
54	100BTB54	3020	22.212	21.498	3	2	5¼	B	62.0	6.5
60	100BTB60	3020	24.601	23.884	3	2	5¼	B	72.0	6.5

# No. 100

## 1 1/4" Pitch

# MST<sup>®</sup> Sprockets

# Martin

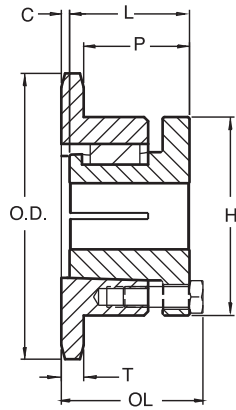

**TYPE 4**

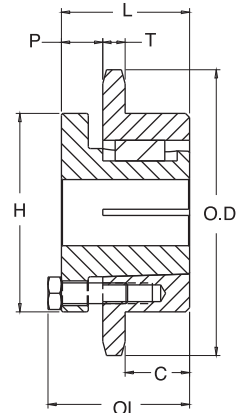

**TYPE 5**

### Single - MST<sup>®</sup> Sprockets

No. Teeth	Catalog Number	Bush-ing	Diameters		Type	Max. Bore	Dimensions						Weight Lbs. (Approx.)	
			Outside Dia.	Pitch Dia.			OL	L	C	H	P	T(nom)	With Hub	Rim Only
11	100P11H	P1	5.010	4.437	4	1-3/4	2-3/16	1-15/16	-	3	1-1/4	0.692	4.1	2.8
12	100Q12H	Q1	5.420	4.830	4	2-11/16	2-27/32	2-1/2	1/16	4-1/8	1-7/8	0.692	7.0	3.5
13	100Q13H	Q1	5.820	5.223	4	2-11/16	2-27/32	2-1/2	1/16	4-1/8	1-7/8	0.692	7.8	4.3
14	100Q14H	Q1	6.230	5.617	4	2-11/16	2-25/32	2-1/2	-	4-1/8	1-13/16	0.692	9.1	5.6
15	100Q15H	Q1	6.630	6.012	4	2-11/16	2-25/32	2-1/2	-	4-1/8	1-13/16	0.692	10.1	6.6
16	100Q16H	Q1	7.030	6.407	4	2-11/16	2-25/32	2-1/2	-	4-1/8	1-13/16	0.692	10.9	7.4
17	100Q17H	Q1	7.440	6.803	4	2-11/16	2-25/32	2-1/2	-	4-1/8	1-13/16	0.692	11.7	8.2
18	100Q18H	Q1	7.840	7.198	4	2-11/16	2-25/32	2-1/2	-	4-1/8	1-13/16	0.692	12.5	9.0
19	100Q19H	Q1	8.240	7.595	4	2-11/16	2-25/32	2-1/2	-	4-1/8	1-13/16	0.692	13.3	9.8
20	100Q20H	Q1	8.640	7.991	4	2-11/16	2-25/32	2-1/2	-	4-1/8	1-13/16	0.692	14.4	10.9
21	100Q21H	Q1	9.040	8.387	4	2-11/16	2-25/32	2-1/2	-	4-1/8	1-13/16	0.692	15.3	11.8
21	100R21H	R1	9.040	8.387	4	3-3/4	3-5/32	2-7/8	-	5-3/8	2-3/16	0.692	20.8	13.3
22	100Q22H	Q1	9.440	8.783	4	2-11/16	2-25/32	2-1/2	-	4-1/8	1-13/16	0.692	16.1	12.6
23	100Q23H	Q1	9.840	9.180	4	2-11/16	2-25/32	2-1/2	-	4-1/8	1-13/16	0.692	17.3	13.8
24	100Q24H	Q1	10.250	9.577	4	2-11/16	2-25/32	2-1/2	-	4-1/8	1-13/16	0.692	18.9	15.4
24	100R24H	R1	10.250	9.577	4	3-3/4	3-5/32	2-7/8	-	5-3/8	2-3/16	0.692	23.1	15.6
25	100Q25H	Q1	10.650	9.973	4	2-11/16	2-25/32	2-1/2	-	4-1/8	1-13/16	0.692	19.5	16.0
25	100R25H	R1	10.650	9.973	4	3-3/4	3-5/32	2-7/8	-	5-3/8	2-3/16	0.692	24.5	17.0
26	100Q26H	Q1	11.050	10.370	4	2-11/16	2-25/32	2-1/2	-	4-1/8	1-13/16	0.692	20.8	17.3
26	100R26H	R1	11.050	10.370	4	3-3/4	3-5/32	2-7/8	-	5-3/8	2-3/16	0.692	25.4	17.9
27	100Q27H	Q1	11.440	10.767	4	2-11/16	2-25/32	2-1/2	-	4-1/8	1-13/16	0.692	21.7	18.2
27	100R27H	R1	11.440	10.767	4	3-3/4	3-5/32	2-7/8	-	5-3/8	2-3/16	0.692	27.1	19.6
28	100Q28H	Q1	11.840	11.164	4	2-11/16	2-25/32	2-1/2	-	4-1/8	1-13/16	0.692	23.1	19.6
28	100R28H	R1	11.840	11.164	4	3-3/4	3-5/32	2-7/8	-	5-3/8	2-3/16	0.692	28.5	21.0
30	100Q30H	Q1	12.640	11.958	4	2-11/16	2-25/32	2-1/2	-	4-1/8	1-13/16	0.692	25.9	22.4
30	100R30H	R1	12.640	11.958	4	3-3/4	3-5/32	2-7/8	-	5-3/8	2-3/16	0.692	32.0	24.5
32	100Q32	Q1	13.440	12.753	4	2-11/16	2-25/32	2-1/2	-	4-1/8	1-13/16	0.692	28.8	25.3
32	100R32	R1	13.440	12.753	4	3-3/4	3-5/32	2-7/8	-	5-3/8	2-3/16	0.692	34.0	26.5
35	100Q35	Q1	14.640	13.945	4	2-11/16	2-25/32	2-1/2	-	4-1/8	1-13/16	0.692	33.7	30.2
35	100R35	R1	14.640	13.945	4	3-3/4	3-5/32	2-7/8	-	5-3/8	2-3/16	0.692	37.3	29.8
36	100R36	R1	15.040	14.342	4	3-3/4	3-5/32	2-7/8	-	5-3/8	2-3/16	0.692	40.5	33.0
40	100R40	R1	16.630	15.932	4	3-3/4	3-5/32	2-7/8	-	5-3/8	2-3/16	0.692	48.4	40.9
42	100R42	R1	17.430	16.727	4	3-3/4	3-5/32	2-7/8	-	5-3/8	2-3/16	0.692	51.8	44.3
45	100R45	R1	18.630	17.920	4	3-3/4	3-5/32	2-7/8	-	5-3/8	2-3/16	0.692	58.0	50.5
48	100R48	R1	19.820	19.112	4	3-3/4	3-5/32	2-7/8	-	5-3/8	2-3/16	0.692	65.0	57.5
54	100R54	R1	22.210	21.498	5	3-3/4	3-5/32	2-7/8	1-5/16	5-3/8	7/8	0.692	76.5	69.0
60	100R60	R1	24.600	23.884	5	3-3/4	3-5/32	2-7/8	1-5/16	5-3/8	7/8	0.692	91.5	84.0
70	100R70	R1	28.580	27.862	5	3-3/4	3-5/32	2-7/8	1-5/16	5-3/8	7/8	0.692	111.5	104.0
72	100R72	R1	29.380	28.657	5	3-3/4	3-5/32	2-7/8	1-5/16	5-3/8	7/8	0.692	113.5	106.0
80	100R80	R1	32.570	31.839	5	3-3/4	3-5/32	2-7/8	1-5/16	5-3/8	7/8	0.692	142.5	135.0
84	100R84	R1	34.160	33.430	5	3-3/4	3-5/32	2-7/8	1-5/16	5-3/8	7/8	0.692	145.5	138.0

Sprockets with "H" suffix have hardened teeth.



### Double - Type B & C

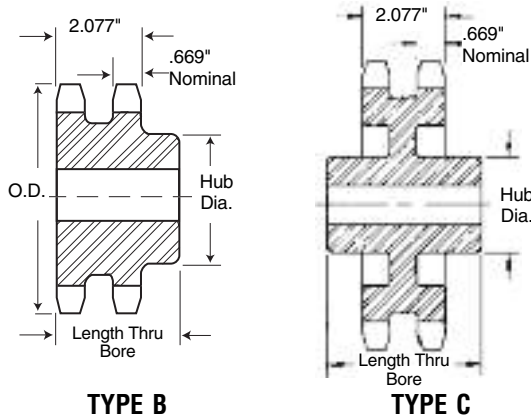

No. Teeth	Catalog Number	Outside Diameter	Type	Bore (inches)		Hub (inches)		Weight Lbs. (Approx.)
				Stock	Rec. Max.	Dia.	Length Thru	
9	D100B9	4.180	B	1	1 1/2	2 1/2	2 1/2	4.6
10	D100B10	4.600	B	1	1 1/2	2 3/4	2 1/2	6.2
11	D100B11	5.010	B	1	2 1/4	3 1/2	2 1/2	7.9
12	D100B12	5.420	B	1 1/2	2 1/4	3 3/4	2 1/2	9.3
13	D100B13	5.820	B	1 1/2	2 3/4	3 3/4	2 3/4	11.4
14	D100B14	6.230	B	1 1/2	2 3/4	4 1/4	2 3/4	13.6
15	D100B15	6.630	B	1 1/2	3 1/4	4 3/4	3 1/4	17.1
16	D100B16	7.030	B	1 1/2	3 1/4	5	3 1/4	20.1
17	D100B17	7.440	B	1 1/2	3 1/2	5 1/4	3 1/4	23.1
18	D100B18	7.840	B	1 1/2	3 1/2	5 1/2	3 1/4	25.4
19	D100B19	8.240	B	1 1/2	3 1/2	5 1/2	3 1/2	29.6
20	D100B20	8.640	B	1 1/2	3 3/4	5 1/2	3 1/2	32.4
21	D100B21	9.040	B	1 1/2	3 3/4	5 1/2	3 3/4	35.3
22	D100B22	9.440	B	1 1/2	3 3/4	5 1/2	3 3/4	38.4
23	D100B23	9.840	B	1 1/2	3 3/4	5 1/2	3 3/4	41.3
24	D100B24	10.250	B	1 1/2	3 3/4	5 1/2	3 3/4	45.1
25	D100B25	10.650	B	1 1/2	3 3/4	5 1/2	3 3/4	48.5
26	D100B26	11.050	B	1 1/2	3 3/4	5 1/2	3 3/4	51.5
30	D100B30	12.640	B	1 1/2	3 3/4	5 1/2	3 3/4	65.0
35	D100C35	14.640	C	1 1/2	3 3/4	6	4 1/4	75.0
45	D100C45	18.630	C	1 1/2	3 3/4	6	4 1/2	103.0
60	D100C60	24.600	C	1 1/2	5	7 1/2	5	175.0
70	D100C70	28.580	C	1 1/2	5	7 1/2	5	197.0
80	D100C80	32.570	C	1 1/2	5	7 1/2	5	231.0

Maximum bores shown will accommodate standard keyseat and setscrew over keyseat. Slightly larger bores are possible with no keyseat, shallow keyseat, or setscrew at angle to keyseat.

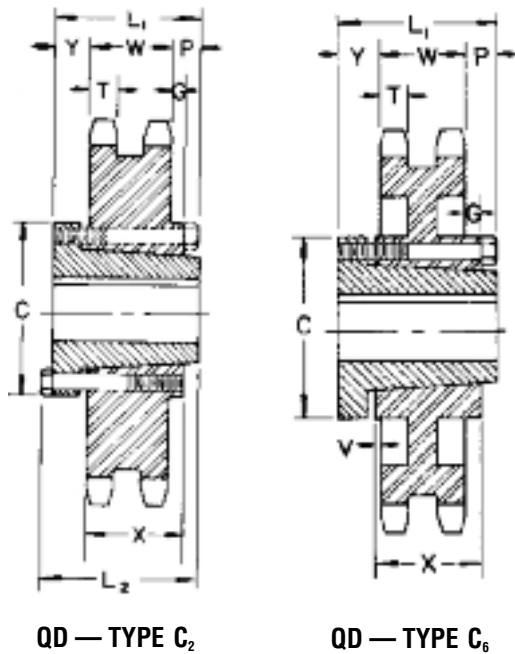

#### Alteration Charges

See current discount sheet for alteration charges.

### Double - Type QD

No. Teeth	Catalog Number	Bush-ing	Diameters		Type	Max. Bore	Dimensions										Weight Lbs. (Approx.)	
			Outside Diameter	Pitch Diameter			L <sub>1</sub>	L <sub>2</sub>	C	Y	P	G	V	X	T	W	With Hub	Rim Only
35	D100F35	F	14.640	13.945	C2	3 1/4	3 3/4	4	6 1/2	1	3/4	2/4	—	2 1/2	0.669	2.077	84.5	73.0
45	D100F45	F	18.630	17.920	C2	3 1/4	3 3/4	4	6 1/2	1	3/4	2/4	—	2 1/2	0.669	2.077	92.5	81.0
60	D100J60	J	24.600	23.884	C6	4 1/4	4 1/2	5	7 1/4	1 1/2	1 1/4	1 1/2	1/2	3 1/4	0.669	2.077	152.0	133.0
70	D100J70	J	28.580	27.862	C6	4 1/4	4 1/2	5	7 1/4	1 1/2	1 1/4	1 1/2	1/2	3 1/4	0.669	2.077	180.0	161.0
80	D100J80	J	32.570	31.839	C6	4 1/4	4 1/2	5	7 1/4	1 1/2	1 1/4	1 1/2	1/2	3 1/4	0.669	2.077	215.0	196.0

# No. 100-2

## 1 1/4" Pitch

# MST® Sprockets

# Martin

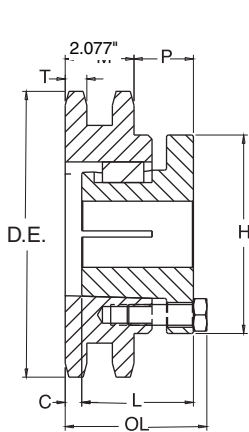

**TYPE 12**

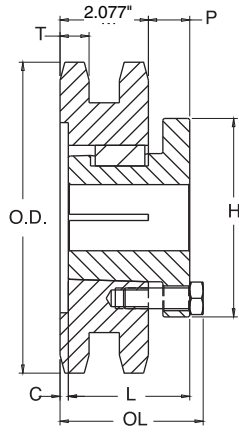

**TYPE 14**

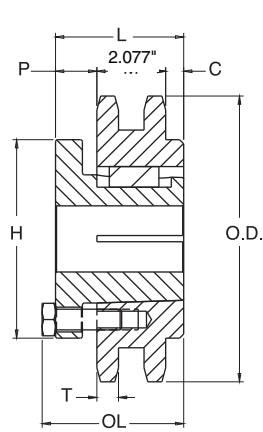

**TYPE 15**

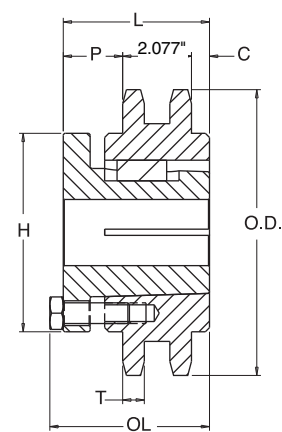

**TYPE 18**

## Double - MST® Sprockets

No. Teeth	Catalog Number	Bush-ing	Diameters		Type	Max. Bore	Dimensions						Weight Lbs. (Approx.)	
			Outside Dia.	Pitch Dia.			OL	L	C	H	P	T(nom)	With Hub	Rim Only
11	D100P11H	P1	5.010	4.437	14	1-3/4	2-15/16	1-15/16	3/4	3	5/8	0.669	6.0	4.7
12	D100Q12H	Q2	5.420	4.830	12	2-5/8	4-7/32	3-1/2	7/16	4-1/8	1-55/64	0.669	10.4	5.9
13	D100Q13H	Q2	5.820	5.223	12	2-5/8	4-7/32	3-1/2	7/16	4-1/8	1-55/64	0.669	12.4	7.9
14	D100Q14H	Q1	6.230	5.617	14	2-11/16	3-3/32	2-1/2	5/16	4-1/8	3/4	0.669	10.9	7.4
15	D100Q15H	Q1	6.630	6.012	14	2-11/16	3-3/32	2-1/2	5/16	4-1/8	3/4	0.669	12.6	9.1
16	D100Q16H	Q1	7.030	6.407	14	2-11/16	3-3/32	2-1/2	5/16	4-1/8	3/4	0.669	14.4	10.9
17	D100R17H	R1	7.440	6.803	14	3-3/4	3-7/32	2-7/8	1/16	5-3/8	7/8	0.669	17.5	10.0
18	D100R18H	R1	7.840	7.198	14	3-3/4	3-7/32	2-7/8	1/16	5-3/8	7/8	0.669	19.8	12.3
19	D100R19	R1	8.240	7.595	14	3-3/4	3-7/32	2-7/8	1/16	5-3/8	7/8	0.669	22.4	14.9
20	D100R20	R1	8.640	7.991	14	3-3/4	3-7/32	2-7/8	1/16	5-3/8	7/8	0.669	24.9	17.4
21	D100R21	R1	9.040	8.387	14	3-3/4	3-7/32	2-7/8	1/16	5-3/8	7/8	0.669	27.8	20.3
22	D100R22	R1	9.440	8.783	14	3-3/4	3-7/32	2-7/8	1/16	5-3/8	7/8	0.669	30.3	22.8
24	D100R24	R1	10.250	9.577	14	3-3/4	3-7/32	2-7/8	1/16	5-3/8	7/8	0.669	37.0	29.5
35	D100R35	R1	14.640	13.945	14	3-3/4	3-7/32	2-7/8	1/16	5-3/8	7/8	0.669	84.3	76.8
45	D100S45	S1	18.630	17.920	15	4-1/4	4-3/4	4-3/8	1-15/64	6-3/8	1-1/16	0.669	151.5	138.0
60	D100S60	S1	24.600	23.884	15	4-1/4	4-3/4	4-3/8	1-15/64	6-3/8	1-1/16	0.669	264.5	251.0
70	D100S70	S1	28.580	27.862	18	4-1/4	7-1/8	6-3/4	2-1/4	6-3/8	2-7/16	0.669	371.5	358.0
80	D100S80	S1	32.570	31.839	18	4-1/4	7-1/8	6-3/4	2-1/4	6-3/8	2-7/16	0.669	444.5	431.0

Sprockets with "H" suffix have hardened teeth.

# Martin

## All Steel Stock Sprockets

# No. 100-3

## 1 1/4" Pitch

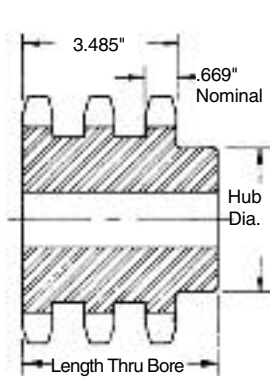

**TYPE B**

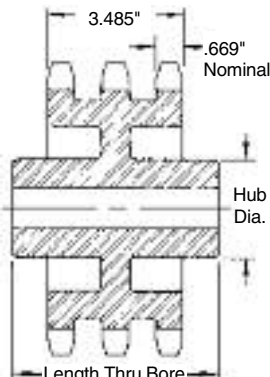

**TYPE C**



### Triple - Type B & C

No. Teeth	Catalog Number	Outside Diameter	Type	Bore (inches)		Hub (inches)		Weight Lbs. (Approx.)
				Stock	Rec. Max.	Dia.	Length Thru	
11	E100B11	5.010	B	1	2 1/2	3 1/2	4 1/4	11.7
12	E100B12	5.420	B	1 1/2	2 1/2	3 3/4	4 1/4	13.7
13	E100B13	5.820	B	1 1/2	2 1/2	3 3/4	4 1/4	16.9
14	E100B14	6.230	B	1 1/2	2 1/2	4 1/4	4 1/4	20.2
15	E100B15	6.630	B	1 1/4	3 1/2	4 1/2	4 1/2	25.0
16	E100B16	7.030	B	1 1/4	3 3/4	5	4 1/2	29.3
17	E100B17	7.440	B	1 1/4	3 1/2	5 1/4	4 1/2	33.8
18	E100B18	7.840	B	1 1/4	3 1/2	5 1/4	4 3/4	38.6
19	E100B19	8.240	B	1 1/4	3 3/4	5 1/2	4 3/4	43.3
20	E100B20	8.640	B	1 1/4	3 3/4	5 1/2	4 3/4	47.9
21	E100B21	9.040	B	1 1/4	3 3/4	5 1/2	4 3/4	52.3
22	E100B22	9.440	B	1 1/4	3 3/4	5 1/2	4 3/4	57.5
23	E100B23	9.840	B	1 1/4	3 3/4	5 1/2	4 3/4	62.5
24	E100B24	10.250	B	1 1/4	3 3/4	5 1/2	4 3/4	69.0
25	E100B25	10.650	B	1 1/4	3 3/4	5 1/2	4 3/4	73.0
26	E100B26	11.050	B	1 1/2	3 3/4	5 1/2	4 3/4	79.0
30	E100B30	12.640	B	1 1/2	3 3/4	5 1/2	4 3/4	103.0
35	E100C35	14.640	C	1 1/2	4	6	5	108.0
45	E100C45	18.630	C	1 1/2	4	6	5	143.0
60	E100C60	24.600	C	1 1/2	5	7 1/2	5	217.0
70	E100C70	28.580	C	1 1/2	5	7 1/2	5	262.0
80	E100C80	32.570	C	1 1/2	5	7 1/2	5	313.0

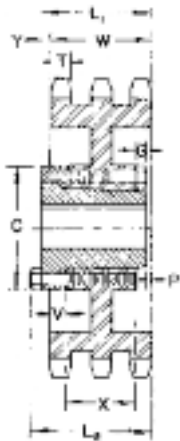

**QD — TYPE B<sub>1</sub>**

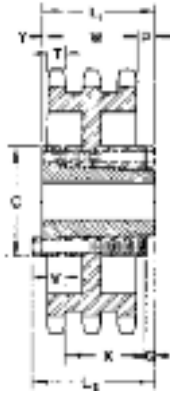

**QD — TYPE C<sub>3</sub>**

Maximum bores shown will accommodate standard keyseat and setscrew over keyseat. Slightly larger bores are possible with no keyseat, shallow keyseat, or setscrew at angle to keyseat.

#### Alteration Charges

See current discount sheet for alteration charges.

### Triple - Type QD

No. Teeth	Catalog Number	Bush-ing	Diameters		Type	Max. Bore	Dimensions										Weight Lbs. (Approx.)	
			Outside Diameter	Pitch Diameter			L <sub>1</sub>	L <sub>2</sub>	C	Y	P	G	V	X	T	W	With Hub	Rim Only
35	E100F35	F	14.640	13.945	B1	3 15/16	3 63/64	4 23/64	6 5/8	1/2	23/64	1/8	1/2	2 1/2	0.669	3.485	112	100
45	E100F45	F	18.630	17.820	B1	3 3/8	3 63/64	4 23/64	6 5/8	1/2	23/64	1/8	1/2	2 1/2	0.669	3.485	139	120
60	E100J60	J	24.600	28.884	C3	4 7/16	4 1/2	5	7 1/4	1/2	33/64	3/8	1 1/16	3 3/16	0.669	3.485	197	178
70	E100J70	J	28.580	27.862	C3	4 7/16	4 1/2	5	7 1/4	1/2	33/64	3/8	1 1/16	3 3/16	0.669	3.485	247	228
80	E100J80	J	32.570	31.839	C3	4 7/16	4 1/2	5	7 1/4	1/2	33/64	3/8	1 1/16	3 3/16	0.669	3.485	287	268

# No. 120

## 1½" Pitch

# All Steel Stock Sprockets

# Martin

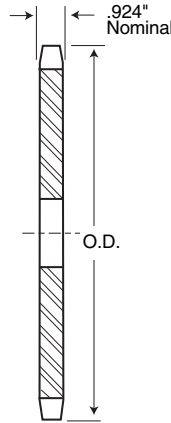

TYPE A

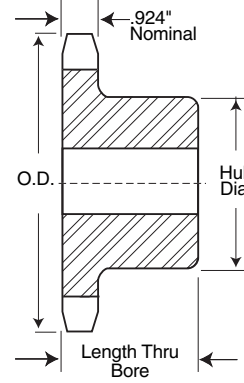

TYPE B

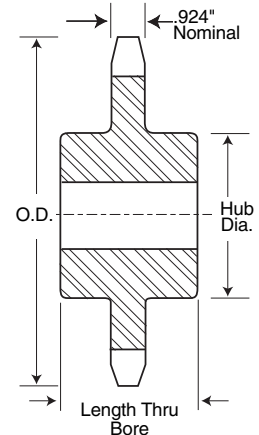

TYPE C

### Single - Type B & C

### Single - Type A

No. Teeth	Catalog Number	Outside Diameter	Type	Bore (inches)		Hub (inches)		Weight Lbs. (Approx.)	Type	Catalog Number	Stock Bore	Weight Lbs. (Approx.)
				Stock	Rec. Max.	Dia.	Length Thru					
8	—	4.520	—	—	—	—	—	—	A	120A8	1¼	2.4
9	120B9	5.020	B	1½	1⅞	3¾★	2¼	5.3	A	120A9	1¼	3.0
10	120B10	5.520	B	1½	2¼	3¾★	2¼	7.1	A	120A10	1¼	3.8
11	120B11	6.010	B	1½	2¾	3¾	2¼	7.6	A	120A11	1¼	4.8
12	120B12	6.500	B	1½	2¾	4¼	2¼	9.9	A	120A12	1¼	5.8
13	120B13	6.990	B	1½	3	4⅞	2¼	12.4	A	120A13	1¼	6.7
14	120B14	7.470	B	1½	3¼	4¾	2¼	14.4	A	120A14	1¼	8.0
15	120B15	7.960	B	1½	3¼	4¾	2¼	16.7	A	120A15	1¼	9.1
16	120B16	8.440	B	1½	3½	5¼	2¼	19.9	A	120A16	1¼	10.6
17	120B17	8.920	B	1½	3½	5¼	2¼	20.8	A	120A17	1¼	12.6
18	120B18	9.410	B	1½	3½	5¼	2¼	22.2	A	120A18	1¼	13.6
19	120B19	9.890	B	1½	3½	5¼	2¼	24.8	A	120A19	1¼	15.1
20	120B20	10.370	B	1½	3½	5¼	2¼	25.8	A	120A20	1¼	16.9
21	120B21	10.850	B	1½	3½	5¼	2¼	26.7	A	120A21	1¼	18.7
22	120B22	11.330	B	1½	3½	5¼	2¼	28.2	A	120A22	1¼	20.0
23	120B23	11.810	B	1½	3½	5¼	2¼	30.3	A	120A23	1¼	22.1
24	120B24	12.290	B	1½	3½	5¼	2¼	32.1	A	120A24	1¼	24.8
25	120B25	12.770	B	1½	3½	5¼	2¼	34.6	A	120A25	1¼	26.8
26	120B26	13.250	B	1½	4	6	2½	40.0	A	120A26	1½	28.3
27	—	13.730	—	—	—	—	—	—	A	120A27	1½	30.9
28	120B28	14.210	B	1½	4	6	2½	44.9	A	120A28	1½	33.6
30	120B30	15.170	B	1½	4	6	2½	50.2	A	120A30	1½	39.0
32	120B32	16.130	B	1½	4	6	2½	56.0	A	120A32	1½	43.9
33	—	16.610	—	—	—	—	—	—	A	120A33	1½	48.2
34	—	17.090	—	—	—	—	—	—	A	120A34	1½	50.0
35	120B35	17.570	B	1½	4	6	2½	62.4	A	120A35	1½	52.0
36	120B36	18.050	B	1½	4	6	2½	66.4	A	120A36	1½	56.0
40	120C40	19.960	C	1½	4	6	3¼	92.0	A	120A40	1½	71.0
42	120C42	20.920	C	1½	4	6	3¾	98.0	A	120A42	1½	75.0
45	120C45	22.350	C	1½	4	6	3¾	99.2	A	120A45	1½	88.0
48	120C48	23.790	C	1½	4	6	4	113.0	A	120A48	1½	103.0
54	120C54	26.650	C	1½	4	6	4	133.0	A	120A54	1½	140.0
60	120C60	29.520	C	1½	5¼	7	4	160.0	A	120A60	1½	160.0
70	120C70	34.300	C	1½	5¾	7½	4¼	206.0	A	120A70	1½	216.0
80	120C80	39.080	C	1½	5¾	7½	4¼	254.0	A	120A80	1½	284.0
90	—	43.850	—	—	—	—	—	—	A	120A90	1½	358.0

★ Has recessed groove in hub for chain clearance.

Maximum bores shown will accommodate standard keyseat and setscrew over keyseat. Slightly larger bores are possible with no keyseat, shallow keyseat, or setscrew at angle to keyseat.

#### Alteration Charges

See current discount sheet for alteration charges.

### Single - Type QD With Hardened Teeth

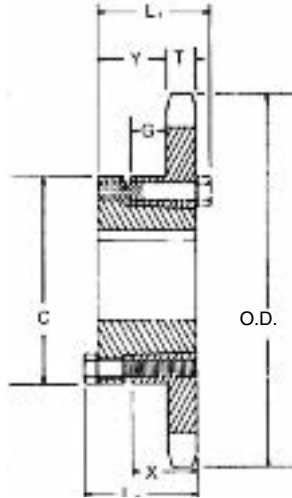

QD — TYPE B

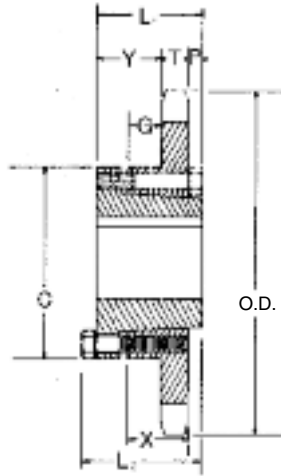

QD — TYPE B<sub>1</sub>

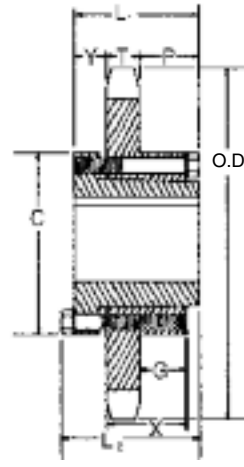

QD — TYPE C

SABER  
TOOTH®

No. Teeth	Catalog Number
12	120SF12H
13	120SF13H
14	120SF14H
15	120SF15H
16	120E16H
17	120E17H
18	120E18H
19	120E19H
20	120E20H
21	120E21H
22	120E22H
23	120E23H
24	120E24H
25	120E25H
26	120E26H
28	120E28H
30	120E30H

### Single - Type QD

No. Teeth	Catalog Number	Bush- ing	Diameters		Type	Max. Bore	Dimensions								Weight Lbs. (Approx.)	
			Outside Diameter	Pitch Diameter			L <sub>1</sub>	L <sub>2</sub>	C	Y	P	G	X	T	With Hub	Rim Only
12	120SF12	SF	6.500	5.796	B	2 <sup>1</sup> / <sub>16</sub>	2 <sup>1</sup> / <sub>4</sub>	2 <sup>1</sup> / <sub>4</sub>	4 <sup>5</sup> / <sub>16</sub>	1 <sup>1</sup> / <sub>4</sub>	—	2 <sup>3</sup> / <sub>64</sub>	1 <sup>1</sup> / <sub>4</sub>	0.924	7.7	4.7
13	120SF13	SF	6.990	6.268	B	2 <sup>1</sup> / <sub>16</sub>	2 <sup>1</sup> / <sub>4</sub>	2 <sup>1</sup> / <sub>4</sub>	4 <sup>5</sup> / <sub>16</sub>	1 <sup>1</sup> / <sub>4</sub>	—	2 <sup>3</sup> / <sub>64</sub>	1 <sup>1</sup> / <sub>4</sub>	0.924	9.1	6.1
14	120SF14	SF	7.470	6.741	B	2 <sup>1</sup> / <sub>16</sub>	2 <sup>1</sup> / <sub>4</sub>	2 <sup>1</sup> / <sub>4</sub>	4 <sup>5</sup> / <sub>16</sub>	1 <sup>1</sup> / <sub>4</sub>	—	2 <sup>3</sup> / <sub>64</sub>	1 <sup>1</sup> / <sub>4</sub>	0.924	10.4	7.4
15	120SF15	SF	7.960	7.215	B	2 <sup>1</sup> / <sub>16</sub>	2 <sup>1</sup> / <sub>4</sub>	2 <sup>1</sup> / <sub>4</sub>	4 <sup>5</sup> / <sub>16</sub>	1 <sup>1</sup> / <sub>4</sub>	—	2 <sup>3</sup> / <sub>64</sub>	1 <sup>1</sup> / <sub>4</sub>	0.924	11.8	8.0
16	120E16	E	8.440	7.689	B1	3 <sup>1</sup> / <sub>2</sub>	2 <sup>5</sup> / <sub>16</sub>	2 <sup>5</sup> / <sub>16</sub>	6	1 <sup>1</sup> / <sub>16</sub>	1 <sup>1</sup> / <sub>8</sub>	5 <sup>5</sup> / <sub>64</sub>	1 <sup>1</sup> / <sub>8</sub>	0.924	21.2	11.2
17	120E17	E	8.920	8.163	B1	3 <sup>1</sup> / <sub>2</sub>	2 <sup>5</sup> / <sub>16</sub>	2 <sup>5</sup> / <sub>16</sub>	6	1 <sup>1</sup> / <sub>16</sub>	1 <sup>1</sup> / <sub>8</sub>	5 <sup>5</sup> / <sub>64</sub>	1 <sup>1</sup> / <sub>8</sub>	0.924	23.4	13.4
18	120E18	E	9.410	8.638	B1	3 <sup>1</sup> / <sub>2</sub>	2 <sup>5</sup> / <sub>16</sub>	2 <sup>5</sup> / <sub>16</sub>	6	1 <sup>1</sup> / <sub>16</sub>	1 <sup>1</sup> / <sub>8</sub>	5 <sup>5</sup> / <sub>64</sub>	1 <sup>1</sup> / <sub>8</sub>	0.924	24.8	14.8
19	120E19	E	9.890	9.113	B1	3 <sup>1</sup> / <sub>2</sub>	2 <sup>5</sup> / <sub>16</sub>	2 <sup>5</sup> / <sub>16</sub>	6	1 <sup>1</sup> / <sub>16</sub>	1 <sup>1</sup> / <sub>8</sub>	5 <sup>5</sup> / <sub>64</sub>	1 <sup>1</sup> / <sub>8</sub>	0.924	26.5	16.5
20	120E20	E	10.370	9.589	B1	3 <sup>1</sup> / <sub>2</sub>	2 <sup>5</sup> / <sub>16</sub>	2 <sup>5</sup> / <sub>16</sub>	6	1 <sup>1</sup> / <sub>16</sub>	1 <sup>1</sup> / <sub>8</sub>	5 <sup>5</sup> / <sub>64</sub>	1 <sup>1</sup> / <sub>8</sub>	0.924	29.2	19.2
21	120E21	E	10.850	10.064	B1	3 <sup>1</sup> / <sub>2</sub>	2 <sup>5</sup> / <sub>16</sub>	2 <sup>5</sup> / <sub>16</sub>	6	1 <sup>1</sup> / <sub>16</sub>	1 <sup>1</sup> / <sub>8</sub>	5 <sup>5</sup> / <sub>64</sub>	1 <sup>1</sup> / <sub>8</sub>	0.924	29.9	19.9
22	120E22	E	11.330	10.540	B1	3 <sup>1</sup> / <sub>2</sub>	2 <sup>5</sup> / <sub>16</sub>	2 <sup>5</sup> / <sub>16</sub>	6	1 <sup>1</sup> / <sub>16</sub>	1 <sup>1</sup> / <sub>8</sub>	5 <sup>5</sup> / <sub>64</sub>	1 <sup>1</sup> / <sub>8</sub>	0.924	31.6	21.6
23	120E23	E	11.810	11.016	B1	3 <sup>1</sup> / <sub>2</sub>	2 <sup>5</sup> / <sub>16</sub>	2 <sup>5</sup> / <sub>16</sub>	6	1 <sup>1</sup> / <sub>16</sub>	1 <sup>1</sup> / <sub>8</sub>	5 <sup>5</sup> / <sub>64</sub>	1 <sup>1</sup> / <sub>8</sub>	0.924	33.8	23.8
24	120E24	E	12.290	11.492	B1	3 <sup>1</sup> / <sub>2</sub>	2 <sup>5</sup> / <sub>16</sub>	2 <sup>5</sup> / <sub>16</sub>	6	1 <sup>1</sup> / <sub>16</sub>	1 <sup>1</sup> / <sub>8</sub>	5 <sup>5</sup> / <sub>64</sub>	1 <sup>1</sup> / <sub>8</sub>	0.924	35.8	25.8
25	120E25	E	12.770	11.968	B1	3 <sup>1</sup> / <sub>2</sub>	2 <sup>5</sup> / <sub>16</sub>	2 <sup>5</sup> / <sub>16</sub>	6	1 <sup>1</sup> / <sub>16</sub>	1 <sup>1</sup> / <sub>8</sub>	5 <sup>5</sup> / <sub>64</sub>	1 <sup>1</sup> / <sub>8</sub>	0.924	38.1	28.1
26	120E26	E	13.250	12.444	B1	3 <sup>1</sup> / <sub>2</sub>	2 <sup>5</sup> / <sub>16</sub>	2 <sup>5</sup> / <sub>16</sub>	6	1 <sup>1</sup> / <sub>16</sub>	1 <sup>1</sup> / <sub>8</sub>	5 <sup>5</sup> / <sub>64</sub>	1 <sup>1</sup> / <sub>8</sub>	0.924	39.9	29.9
28	120E28	E	14.210	13.397	B1	3 <sup>1</sup> / <sub>2</sub>	2 <sup>5</sup> / <sub>16</sub>	2 <sup>5</sup> / <sub>16</sub>	6	1 <sup>1</sup> / <sub>16</sub>	1 <sup>1</sup> / <sub>8</sub>	5 <sup>5</sup> / <sub>64</sub>	1 <sup>1</sup> / <sub>8</sub>	0.924	49.7	34.7
30	120E30	E	15.170	14.350	B1	3 <sup>1</sup> / <sub>2</sub>	2 <sup>5</sup> / <sub>16</sub>	2 <sup>5</sup> / <sub>16</sub>	6	1 <sup>1</sup> / <sub>16</sub>	1 <sup>1</sup> / <sub>8</sub>	5 <sup>5</sup> / <sub>64</sub>	1 <sup>1</sup> / <sub>8</sub>	0.924	49.4	39.4
32	120F32	F	16.130	15.303	C	3 <sup>3</sup> / <sub>16</sub>	3 <sup>3</sup> / <sub>8</sub>	4	6 <sup>5</sup> / <sub>16</sub>	1	1 <sup>1</sup> / <sub>16</sub>	1 <sup>3</sup> / <sub>64</sub>	2 <sup>1</sup> / <sub>2</sub>	0.924	62.0	50.5
35	120F35	F	17.570	16.734	C	3 <sup>3</sup> / <sub>16</sub>	3 <sup>3</sup> / <sub>8</sub>	4	6 <sup>5</sup> / <sub>16</sub>	1	1 <sup>1</sup> / <sub>16</sub>	1 <sup>3</sup> / <sub>64</sub>	2 <sup>1</sup> / <sub>2</sub>	0.924	71.0	59.5
36	120F36	F	18.050	17.211	C	3 <sup>3</sup> / <sub>16</sub>	3 <sup>3</sup> / <sub>8</sub>	4	6 <sup>5</sup> / <sub>16</sub>	1	1 <sup>1</sup> / <sub>16</sub>	1 <sup>3</sup> / <sub>64</sub>	2 <sup>1</sup> / <sub>2</sub>	0.924	74.9	63.4
40	120F40	F	19.960	19.118	C	3 <sup>3</sup> / <sub>16</sub>	3 <sup>3</sup> / <sub>8</sub>	4	6 <sup>5</sup> / <sub>16</sub>	1	1 <sup>1</sup> / <sub>16</sub>	1 <sup>3</sup> / <sub>64</sub>	2 <sup>1</sup> / <sub>2</sub>	0.924	88.5	77.0
42	120F42	F	20.920	20.072	C	3 <sup>3</sup> / <sub>16</sub>	3 <sup>3</sup> / <sub>8</sub>	4	6 <sup>5</sup> / <sub>16</sub>	1	1 <sup>1</sup> / <sub>16</sub>	1 <sup>3</sup> / <sub>64</sub>	2 <sup>1</sup> / <sub>2</sub>	0.924	94.5	83.0
45	120F45	F	22.350	21.503	C	3 <sup>3</sup> / <sub>16</sub>	3 <sup>3</sup> / <sub>8</sub>	4	6 <sup>5</sup> / <sub>16</sub>	1	1 <sup>1</sup> / <sub>16</sub>	1 <sup>3</sup> / <sub>64</sub>	2 <sup>1</sup> / <sub>2</sub>	0.924	95.5	84.0
48	120F48	F	23.790	22.935	C	3 <sup>3</sup> / <sub>16</sub>	3 <sup>3</sup> / <sub>8</sub>	4	6 <sup>5</sup> / <sub>16</sub>	1	1 <sup>1</sup> / <sub>16</sub>	1 <sup>3</sup> / <sub>64</sub>	2 <sup>1</sup> / <sub>2</sub>	0.924	103.5	92.0
54	120F54	F	26.650	25.798	C	3 <sup>3</sup> / <sub>16</sub>	3 <sup>3</sup> / <sub>8</sub>	4	6 <sup>5</sup> / <sub>16</sub>	1	1 <sup>1</sup> / <sub>16</sub>	1 <sup>3</sup> / <sub>64</sub>	2 <sup>1</sup> / <sub>2</sub>	0.924	125.0	114.0
60	120J60	J	29.520	28.661	C	4 <sup>1</sup> / <sub>16</sub>	4 <sup>1</sup> / <sub>2</sub>	5	7 <sup>1</sup> / <sub>4</sub>	1 <sup>1</sup> / <sub>16</sub>	2 <sup>1</sup> / <sub>16</sub>	2 <sup>1</sup> / <sub>64</sub>	3 <sup>1</sup> / <sub>16</sub>	0.924	159.0	140.0
70	120J70	J	34.300	33.434	C	4 <sup>1</sup> / <sub>16</sub>	4 <sup>1</sup> / <sub>2</sub>	5	7 <sup>1</sup> / <sub>4</sub>	1 <sup>1</sup> / <sub>16</sub>	2 <sup>1</sup> / <sub>16</sub>	2 <sup>1</sup> / <sub>64</sub>	3 <sup>1</sup> / <sub>16</sub>	0.924	196.0	177.0
80	120J80	J	39.080	38.207	C	4 <sup>1</sup> / <sub>16</sub>	4 <sup>1</sup> / <sub>2</sub>	5	7 <sup>1</sup> / <sub>4</sub>	1 <sup>1</sup> / <sub>16</sub>	2 <sup>1</sup> / <sub>16</sub>	2 <sup>1</sup> / <sub>64</sub>	3 <sup>1</sup> / <sub>16</sub>	0.924	241.0	222.0

# No. 120 1½" Pitch

# All Steel Stock Sprockets

## Single - Taper Bushed

No. Teeth	Catalog Number	Bushing	Diameter		Max. Bore	Dimensions		Type	Weight Lbs. (Approx.)	
			Outside Diameter	Pitch Diameter		L	C		Rim Only	Bushing Only
12	120BTB12	2012	6.498	5.796	2	1¼	3⅞	B	5.5	1.7
13	120BTB13	2517	6.896	6.268	2½	1¼	4¼	B	6.0	3.5
14	120BTB14	2517	7.472	6.741	2½	1¼	4¼	B	7.0	3.5
15	120BTB15	2517	7.957	7.215	2½	1¼	4¼	B	8.0	3.5
16	120BTB16	3020	8.441	7.689	3	2	5¼	B	10.0	6.5
17	120BTB17	3020	8.924	8.163	3	2	5¼	B	11.0	6.5
18	120BTB18	3020	9.407	8.638	3	2	5¼	B	12.0	6.5
19	120BTB19	3020	9.889	9.113	3	2	5¼	B	14.0	6.5
20	120BTB20	3020	10.371	9.588	3	2	5¼	B	15.5	6.5
21	120BTB21	3020	10.851	10.064	3	2	5¼	B	17.5	6.5
24	120BTB24	3020	12.294	11.492	3	2	5¼	B	23.5	6.5
26	120BTB26	3020	13.254	12.444	3	2	5¼	B	28.5	6.5
30	120BTB30	3020	15.171	14.351	3	2	5¼	B	33.5	6.5
35	120CTB35	3020	17.566	16.734	3	2	5¼	C	52.0	6.5
45	120CTB45	3030	22.351	21.503	3	3	5¼	C	82.0	9.2
60	120CTB60	3535	29.522	28.661	3½	3½	6¼	C	140.0	14.0
70	120CTB70	3535	34.301	33.434	3½	3½	6¼	C	175.0	14.0
80	120CTB80	3535	39.078	38.207	3½	3½	6¼	C	220.0	14.0

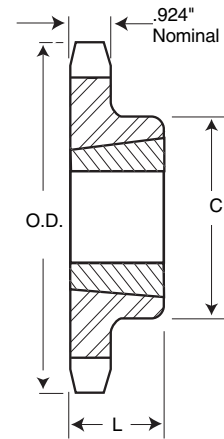

TYPE B

## Single - Taper Bushed with Hardened Teeth

No. Teeth	Catalog Number
12	120BTB12 H
13	120BTB13 H
14	120BTB14 H
15	120BTB15 H
16	120BTB16 H
17	120BTB17 H
18	120BTB18 H
19	120BTB19 H
20	120BTB20 H
21	120BTB21 H
24	120BTB24 H
26	120BTB26 H
30	120BTB30 H

**SABER  
TOOTH®**

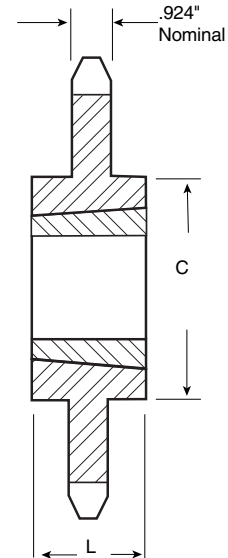

TYPE C

## Single - Type C — Steel 1½" Pitch

No. Teeth	Catalog Number	Outside Diameter	Bore (inches)		Hub (inches)		Weight Lbs. (Approx.)
			Stock	Rec. Max.	Diameter	Length	
11	120C11	6.010	1%	2%	3⅞	3%	12.45
12	120C12	6.500	1%	2%	4⅞	3%	14.80
13	120C13	6.990	1%	3	4%	3%	17.15
14	120C14	7.470	1%	3¼	4%	3%	19.50

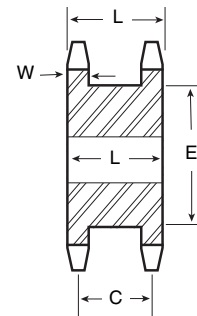

TYPE A

## Double Single - Type A — Steel

No. Teeth	Catalog Number	Diameters		Type	Min. Bore	Max. Bore	Dimensions				Wt. Lbs. (Approx.)
		Outside Diameter	Pitch Diameter				L	C	E	w Nom.	
15	DS120A15	7.960	7.215	A	1⅞	3¾	3⅞	2⅞	5⅞	0.924	30.0
16	DS120A16	8.440	7.689	A	1⅞	4	3⅞	2⅞	6	0.924	34.0
17	DS120A17	8.920	8.163	A	1⅞	4⅞	3⅞	2⅞	6⅞	0.924	37.0
18	DS120A18	9.410	8.638	A	1⅞	5%	3⅞	2⅞	6⅞	0.924	42.0
19	DS120A19	9.890	9.113	A	1⅞	5½	3⅞	2⅞	7⅞	0.924	47.0
20	DS120A20	10.370	9.589	A	1⅞	5⅞	3⅞	2⅞	7⅞	0.924	51.0

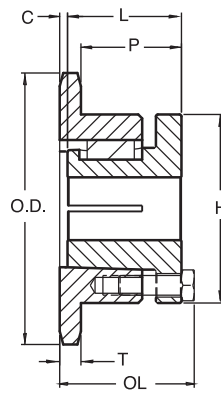

**TYPE 4**

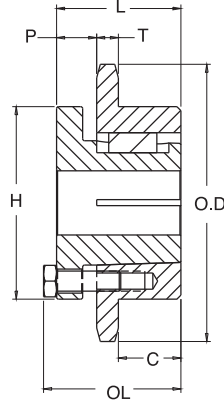

**TYPE 5**

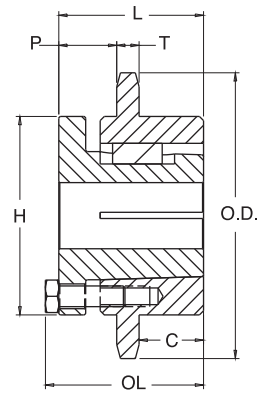

**TYPE 6**

## Single - MST® Sprockets

No. Teeth	Catalog Number	Bush- ing	Diameters		Type	Max. Bore	Dimensions						Weight Lbs. (Approx.)	
			Outside Dia.	Pitch Dia.			OL	L	C	H	P	T(nom)	With Hub	Rim Only
11	120Q11H	Q1	6.010	5.324	4	2-11/16	2-25/32	2-1/2	-	4-1/8	1 9/16	0.924	8.3	4.8
12	120Q12H	Q1	6.500	5.796	4	2-11/16	2-25/32	2-1/2	-	4-1/8	1 9/16	0.924	9.8	6.3
13	120Q13H	Q1	6.990	6.268	4	2-11/16	2-25/32	2-1/2	-	4-1/8	1 9/16	0.924	11.4	7.9
14	120Q14H	Q1	7.470	6.741	4	2-11/16	2-25/32	2-1/2	-	4-1/8	1 9/16	0.924	12.7	9.2
15	120Q15H	Q1	7.960	7.215	4	2-11/16	2-25/32	2-1/2	-	4-1/8	1 9/16	0.924	13.9	10.4
16	120Q16H	Q1	8.440	7.689	4	2-11/16	2-25/32	2-1/2	-	4-1/8	1-15/16	0.924	15.3	11.8
16	120R16H	R1	8.440	7.689	4	3-3/4	3-5/32	2-7/8	-	5-3/8	1-15/16	0.924	19.5	12.0
17	120Q17H	Q1	8.920	8.163	4	2-11/16	2-25/32	2-1/2	-	4-1/8	1-15/16	0.924	16.9	13.4
17	120R17H	R1	8.920	8.163	4	3-3/4	3-5/32	2-7/8	-	5-3/8	1-15/16	0.924	21.2	13.7
18	120Q18H	Q1	9.410	8.638	4	2-11/16	2-25/32	2-1/2	-	4-1/8	1-15/16	0.924	19.1	15.6
18	120R18H	R1	9.410	8.638	4	3-3/4	3-5/32	2-7/8	-	5-3/8	1-15/16	0.924	22.5	15.0
19	120R19H	R1	9.890	9.113	4	3-3/4	3-5/32	2-7/8	-	5-3/8	1-15/16	0.924	24.4	16.9
20	120R20H	R1	10.370	9.589	4	3-3/4	3-5/32	2-7/8	-	5-3/8	1-15/16	0.924	26.3	18.8
21	120R21H	R1	10.850	10.064	4	3-3/4	3-5/32	2-7/8	-	5-3/8	1-15/16	0.924	28.2	20.7
22	120R22H	R1	11.330	10.540	4	3-3/4	3-5/32	2-7/8	-	5-3/8	1-15/16	0.924	30.0	22.5
23	120R23H	R1	11.810	11.016	4	3-3/4	3-5/32	2-7/8	-	5-3/8	1-15/16	0.924	31.8	24.3
24	120R24H	R1	12.290	11.492	4	3-3/4	3-5/32	2-7/8	-	5-3/8	1-15/16	0.924	34.6	27.1
25	120R25H	R1	12.770	11.968	4	3-3/4	3-5/32	2-7/8	-	5-3/8	1-15/16	0.924	36.6	29.1
26	120R26H	R1	13.250	12.444	5	3-3/4	3-5/32	2-7/8	1-1/16	5-3/8	7/8	0.924	40.8	33.3
28	120R28H	R1	14.210	13.397	5	3-3/4	3-5/32	2-7/8	1-1/16	5-3/8	7/8	0.924	45.5	38.0
30	120R30H	R1	15.170	14.350	5	3-3/4	3-5/32	2-7/8	1-1/16	5-3/8	7/8	0.924	50.8	43.3
32	120R32	R1	16.130	15.303	5	3-3/4	3-5/32	2-7/8	1-1/16	5-3/8	7/8	0.924	56.9	49.4
35	120R35	R2	17.570	16.734	6	3-5/8	5-5/32	4-7/8	2	5-3/8	1-15/16	0.924	79.0	68.0
36	120R36	R2	18.050	17.211	6	3-5/8	5-5/32	4-7/8	2	5-3/8	1-15/16	0.924	83.0	72.0
40	120R40	R2	19.960	19.118	6	3-5/8	5-5/32	4-7/8	2	5-3/8	1-15/16	0.924	93.0	82.0
40	120S40	S1	19.960	19.118	5	4-1/4	4-3/4	4-3/8	2-3/8	6-3/8	1-1/16	0.924	96.5	83.0
42	120S42	S1	20.920	20.072	5	4-1/4	4-3/4	4-3/8	2-3/8	6-3/8	1-1/16	0.924	103.5	90.0
45	120R45	R2	22.350	21.503	6	3-5/8	5-5/32	4-7/8	2	5-3/8	1-15/16	0.924	113.0	102.0
45	120S45	S1	22.350	21.503	5	4-1/4	4-3/4	4-3/8	2-3/8	6-3/8	1-1/16	0.924	113.5	100.0
48	120S48	S1	23.790	22.935	5	4-1/4	4-3/4	4-3/8	2-3/8	6-3/8	1-1/16	0.924	124.5	111.0
54	120S54	S1	26.650	25.798	5	4-1/4	4-3/4	4-3/8	2-3/8	6-3/8	1-1/16	0.924	151.5	138.0
60	120R60	R2	29.520	28.661	6	3-5/8	5-5/32	4-7/8	2	5-3/8	1-15/16	0.924	190.0	179.0
60	120S60	S1	29.520	28.661	5	4-1/4	4-3/4	4-3/8	2-3/8	6-3/8	1-1/16	0.924	193.5	180.0
70	120R70	R2	34.300	33.434	6	3-5/8	5-5/32	4-7/8	2	5-3/8	1-15/16	0.924	159.0	148.0
70	120S70	S2	34.300	33.434	5	4-3/16	7-1/8	6-3/4	2-7/8	6-3/8	2-15/16	0.924	186.0	167.0
80	120R80	R2	39.080	38.207	6	3-5/8	5-5/32	4-7/8	2	5-3/8	1-15/16	0.924	302.0	291.0
80	120S80	S2	39.080	38.207	6	4-3/16	7-1/8	6-3/4	2-7/8	6-3/8	2-15/16	0.924	324.0	305.0

Sprockets with "H" suffix have hardened teeth.

# No. 120-2

## 1½" Pitch

# All Steel Stock Sprockets

# Martin

### Double - Type B & C

No. Teeth	Catalog Number	Outside Diameter	Type	Bore (inches)		Hub (inches)		Weight Lbs. (Approx.)
				Stock	Rec. Max.	Dia.	Length Thru	
11	D120B11	6.010	B	1½	2%	3¼	3%	13.6
12	D120B12	6.500	B	1½	2%	4¼	3%	17.3
13	D120B13	6.990	B	1½	3	4½	3%	21.1
14	D120B14	7.470	B	1½	3⅝	5	3%	25.6
15	D120B15	7.960	B	1½	3½	5¼	3%	29.9
16	D120B16	8.440	B	1½	3½	5¼	3%	33.8
17	D120B17	8.920	B	1½	3½	5¼	3%	36.9
18	D120B18	9.410	B	1½	3½	5¼	3%	41.9
19	D120B19	9.890	B	1½	3½	5¼	3%	46.5
20	D120B20	10.370	B	1½	3½	5¼	3%	50.2
21	D120B21	10.850	B	1½	3½	5¼	3%	55.6
22	D120B22	11.330	B	1½	3⅝	5¼	4	64.0
23	D120B23	11.810	B	1½	4	6¼	4	75.0
24	D120B24	12.290	B	1½	4	6¼	4	79.0
25	D120B25	12.770	B	1½	4	6¼	4	84.0
26	D120B26	13.250	B	1½	4	6¼	4	90.0
30	D120B30	15.170	B	1½	4	6¼	4	119.0
35	D120C35	17.570	C	1½	5%	7½	6	148.0
45	D120C45	22.350	C	1½	5%	7½	6	188.0
60	D120C60	29.520	C	1½	6%	9½	6¼	307.0

Maximum bores shown will accommodate standard keyseat and setscrew over keyseat. Slightly larger bores are possible with no keyseat, shallow keyseat, or setscrew at angle to keyseat.

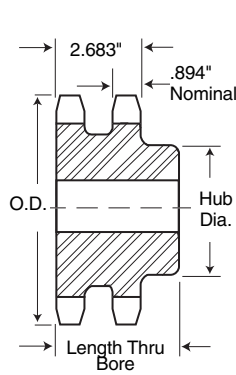

TYPE B

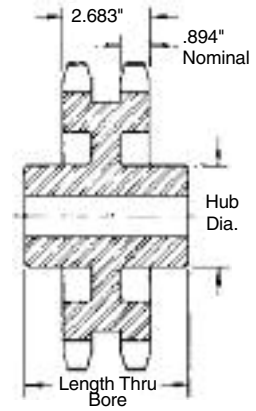

TYPE C

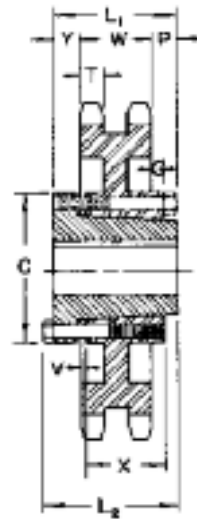

QD — TYPE C<sub>5</sub>

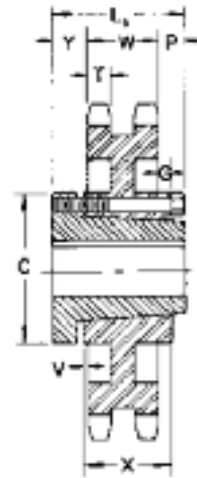

QD — TYPE C<sub>6</sub>

#### Alteration Charges

See current discount sheet for alteration charges.

### Double - Type QD

No. Teeth	Catalog Number	Bush-ing	Diameters		Type	Max. Bore	Dimensions										Weight Lbs. (Approx.)	
			Outside Diameter	Pitch Diameter			L <sub>1</sub>	L <sub>2</sub>	C	Y	P	G	V	X	T	W	With Hub	Rim Only
30	D120J30	J	15.170	14.350	C5	4¼	4½	5	7¼	1½	⅝	2¼	⅝	3⅝	.894	2.683	97.5	78.0
35	D120J35	J	17.570	16.734	C5	4¼	4½	5	7¼	1½	⅝	2¼	⅝	3⅝	.894	2.683	112.0	93.0
45	D120J45	J	22.350	21.502	C5	4¼	4½	5	7¼	1½	⅝	2¼	⅝	3⅝	.894	2.683	157.0	138.0
60	D120M60	M	29.520	28.661	C6	5½	6¼	6¼	9	2½	1⅝	1⅝	2¼	5⅝	.894	2.683	271.0	234.0



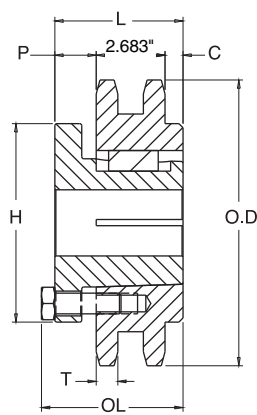

**TYPE 15**

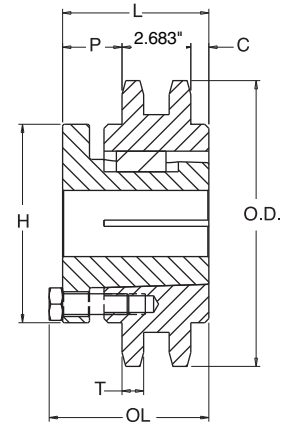

**TYPE 18**

### Double - MST® Sprockets

No. Teeth	Catalog Number	Bush- ing	Diameters		Type	Max. Bore	Dimensions						Weight Lbs. (Approx.)	
			Outside Dia.	Pitch Dia.			OL	L	C	H	P	T(nom)	With Hub	Rim Only
30	D120S30	S1	15.170	14.350	15	4-1/4	4-3/4	4-3/8	5/8	6-3/8	1-1/16	0.894	118.5	105.0
35	D120S35	S1	17.570	16.734	15	4-1/4	4-3/4	4-3/8	5/8	6-3/8	1-1/16	0.894	161.5	148.0
45	D120S45	S2	22.350	21.503	18	4-3/16	7-1/8	6-3/4	1-27/32	6-3/8	2-7/32	0.894	287.0	268.0
60	D120U60	U0	29.520	28.661	15	5-1/2	5-23/32	5-1/4	1-9/32	8-3/8	19/32	0.894	213.0	183.0

Sprockets with "H" suffix have hardened teeth.

# No. 140

## 1 3/4" Pitch

# All Steel Stock Sprockets

# Martin

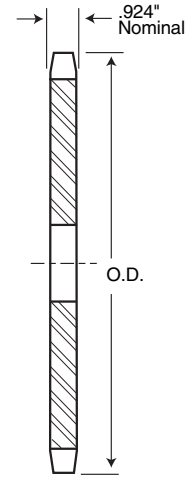

**TYPE A**

### Single - Type B & C

### Single - Type A

No. Teeth	Catalog Number	Outside Diameter	Type	Bore (inches)		Hub (inches)		Weight Lbs (Approx.)	Type	Catalog Number	Stock Bore	Weight Lbs. (Approx.)
				Stock	Rec. Max.	Dia.	Length Thru					
11	140B11	7.010	B	1 1/2	2 3/4	4 1/4	2 1/4	11.3	A	140A11	1 1/2	5.0
12	140B12	7.580	B	1 1/2	3	4 1/2	2 1/4	13.2	A	140A12	1 1/2	7.8
13	140B13	8.150	B	1 1/2	3 5/16	5 1/16	2 3/8	18.9	A	140A13	1 1/2	8.2
14	140B14	8.720	B	1 1/2	3 3/8	5 1/2	2 3/8	20.4	A	140A14	1 1/2	10.0
15	140B15	9.280	B	1 1/2	4 1/4	6 1/4	2 3/8	25.1	A	140A15	1 1/2	11.0
16	140B16	9.850	B	1 1/2	4 1/4	6 1/4	2 1/2	27.9	A	140A16	1 1/2	14.0
17	140B17	10.410	B	1 1/2	4 1/4	6 1/4	2 1/2	29.8	A	140A17	1 1/2	16.0
18	140B18	10.980	B	1 1/2	4 1/4	6 1/4	2 1/2	32.0	A	140A18	1 1/2	18.0
19	140B19	11.540	B	1 1/2	4 1/4	6 1/4	2 1/2	34.1	A	140A19	1 1/2	21.0
20	140B20	12.100	B	1 1/2	4 1/4	6 1/4	2 1/2	36.0	A	140A20	1 1/2	23.0
21	140B21	12.660	B	1 1/2	4 1/4	6 1/4	2 1/2	38.7	A	140A21	1 1/2	25.0
22	140B22	13.220	B	1 1/2	4 1/4	6 1/4	2 1/2	40.6	A	140A22	1 1/2	28.0
23	140B23	13.780	B	1 1/2	4 1/4	6 1/4	2 1/2	42.1	A	140A23	1 1/2	30.0
24	140B24	14.340	B	1 1/2	4 1/4	6 1/4	2 1/2	46.2	A	140A24	1 1/2	33.0
25	140B25	14.900	B	1 1/2	4 1/4	6 1/4	2 1/2	47.8	A	140A25	1 1/2	34.0
26	140B26	15.460	B	1 1/2	4 1/4	6 1/4	3	57.2	A	140A26	1 1/2	39.0
27	140B27	16.020	B	1 1/2	4 1/4	6 1/4	3	58.5	A	140A27	1 1/2	41.0
28	140B28	16.580	B	1 1/2	4 1/4	6 1/4	3	62.2	A	140A28	1 1/2	45.0
30	140B30	17.700	B	1 1/2	4 1/4	6 1/4	3	69.8	A	140A30	1 1/2	52.0
31	-	18.260	-	-	-	-	-	-	-	140A31	1 1/2	56.0
32	140B32	18.820	B	1 1/2	4 1/4	6 1/4	3	76.3	A	140A32	1 1/2	60.0
35	140C35	20.490	C	1 1/2	5 1/4	7	4	108.0	A	140A35	1 1/2	73.0
36	-	21.050	-	-	-	-	-	-	A	140A36	1 1/2	77.0
40	140C40	23.290	C	1 1/2	5 1/4	7	4	121.0	A	140A40	1 1/2	93.0
45	140C45	26.080	C	1 1/2	5 1/4	7	4	142.0	A	140A45	1 1/2	131.0
48	140C48	27.750	C	1 1/2	5 1/4	7	4	150.0	A	140A48	1 1/2	134.0
54	140C54	31.100	C	1 1/2	5 1/4	7	4	177.0	A	140A54	1 1/2	173.0
60	140C60	34.440	C	1 1/2	5 1/4	7	5	220.0	A	140A60	1 1/2	219.0
70	140C70	40.020	C	1 1/2	5 1/4	7 1/2	5	282.0	A	140A70	1 1/2	292.0
80	140C80	45.590	C	1 1/2	5 1/4	7 1/2	5	331.0	A	140A80	1 1/2	402.0

Maximum bores shown will accommodate standard keyseat and setscrew over keyseat. Slightly larger bores are possible with no keyseat, shallow keyseat, or setscrew at angle to keyseat.

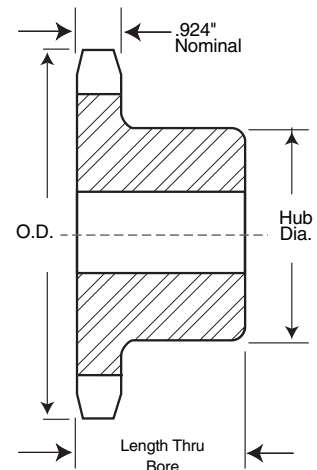

**TYPE B**

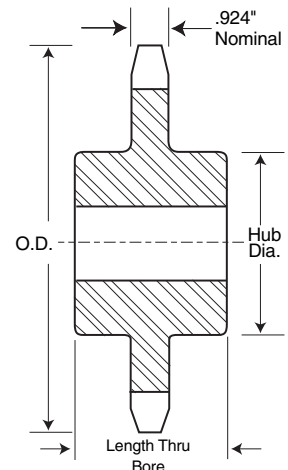

**TYPE C**

#### Alteration Charges

See current discount sheet for alteration charges.

### Single - Type QD With Hardened Teeth

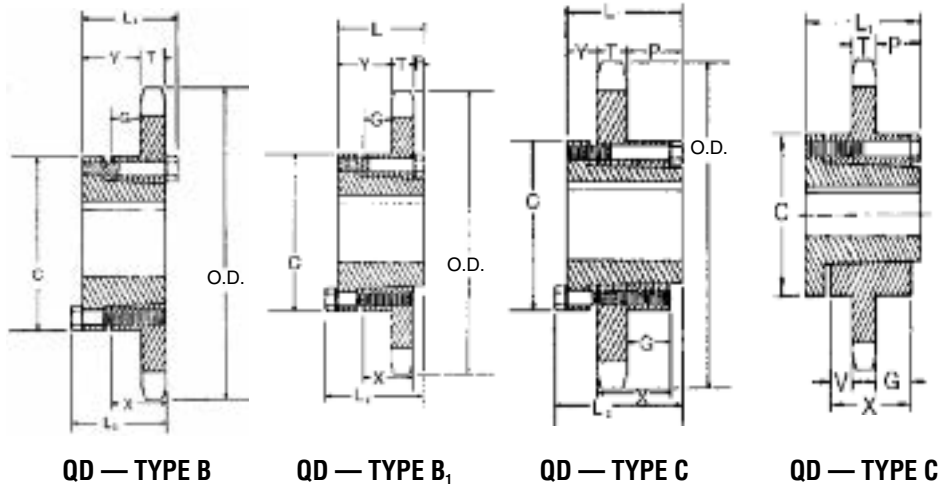

S  
A  
B  
E  
R  
  
T  
O  
O  
T  
®

No. Teeth	Catalog Number
11	140SF11 H
12	140SF12 H
13	140SF13 H
14	140E14 H
15	140E15 H
16	140E16 H
17	140E17 H
18	140E18 H
19	140E19 H
20	140E20 H
21	140E21 H
22	140E22 H
23	140F23 H
24	140F24 H
25	140F25 H
26	140F26 H
30	140F30 H

### Single - Type QD

No. Teeth	Catalog Number	Bush- ing	Diameters		Type	Max. Bore	Dimensions										Weight Lbs. (Approx.)	
			Outside Diameter	Pitch Diameter			L <sub>1</sub>	L <sub>2</sub>	C	Y	P	G	V	X	T	With Hub	Rim Only	
11	140SF11	SF	7.010	6.212	B	2 <sup>15</sup> / <sub>16</sub>	2 1/4	2 1/4	4 5/8	1 3/4	—	2 1/4	—	1 1/4	0.924	8.6	5.6	
12	140SF12	SF	7.580	6.762	B	2 <sup>15</sup> / <sub>16</sub>	2 1/4	2 1/4	4 5/8	1 3/4	—	2 1/4	—	1 1/4	0.924	10.4	7.4	
13	140SF13	SF	8.150	7.313	B	2 <sup>15</sup> / <sub>16</sub>	2 1/4	2 1/4	4 5/8	1 3/4	—	2 1/4	—	1 1/4	0.924	11.9	8.9	
14	140E14	E	8.720	7.864	B1	3 1/2	2 5/8	2 15/16	6	1 1/8	1/8	4 5/8	—	1 5/8	0.924	21.6	11.6	
15	140E15	E	9.280	8.417	B1	3 1/2	2 5/8	2 15/16	6	1 1/8	1/8	4 5/8	—	1 5/8	0.924	24.2	14.2	
16	140E16	E	9.850	8.970	B1	3 1/2	2 5/8	2 15/16	6	1 1/8	1/8	4 5/8	—	1 5/8	0.924	25.9	15.9	
17	140E17	E	10.410	9.524	B1	3 1/2	2 5/8	2 15/16	6	1 1/8	1/8	4 5/8	—	1 5/8	0.924	28.0	18.0	
18	140E18	E	10.980	10.078	B1	3 1/2	2 5/8	2 15/16	6	1 1/8	1/8	4 5/8	—	1 5/8	0.924	29.6	19.6	
19	140E19	E	11.540	10.632	B1	3 1/2	2 5/8	2 15/16	6	1 1/8	1/8	4 5/8	—	1 5/8	0.924	32.0	22.0	
20	140E20	E	12.100	11.187	B1	3 1/2	2 5/8	2 15/16	6	1 1/8	1/8	4 5/8	—	1 5/8	0.924	34.6	24.6	
21	140E21	E	12.660	11.742	B1	3 1/2	2 5/8	2 15/16	6	1 1/8	1/8	4 5/8	—	1 5/8	0.924	37.6	27.6	
22	140E22	E	13.220	12.297	B1	3 1/2	2 5/8	2 15/16	6	1 1/8	1/8	4 5/8	—	1 5/8	0.924	39.5	29.5	
23	140F23	F	13.780	12.852	B1	3 15/16	3 3/8	4	6 3/8	2 1/8	1/8	1 3/4	—	2 1/2	0.924	48.0	36.4	
24	140F24	F	14.340	13.407	B1	3 15/16	3 3/8	4	6 3/8	2 1/8	1/8	1 3/4	—	2 1/2	0.924	51.6	40.1	
25	140F25	F	14.900	13.963	B1	3 15/16	3 3/8	4	6 3/8	2 1/8	1/8	1 3/4	—	2 1/2	0.924	53.8	42.3	
26	140F26	F	15.460	14.518	B1	3 15/16	3 3/8	4	6 3/8	2 1/8	1/8	1 3/4	—	2 1/2	0.924	58.0	46.5	
30	140F30	F	17.700	16.742	B1	3 15/16	3 3/8	4	6 3/8	2 1/8	1/8	1 3/4	—	2 1/2	0.924	72.0	60.4	
35	140F35	F	20.490	19.523	C	3 15/16	3 3/8	4	6 3/8	1	1 1/16	1 3/4	—	2 1/2	0.924	89.5	78.0	
36	140F36	F	21.050	20.079	C	3 15/16	3 3/8	4	6 3/8	1	1 1/16	1 3/4	—	2 1/2	0.924	95.5	84.0	
40	140J40	J	23.290	22.305	C	4 1/8	4 1/2	5	7 1/4	1 1/8	2 3/8	2 1/4	—	3 3/8	0.924	117.0	98.0	
45	140J45	J	26.080	25.087	C	4 1/8	4 1/2	5	7 1/4	1 1/8	2 3/8	2 1/4	—	3 3/8	0.924	139.0	120.0	
48	140J48	J	27.750	26.757	C	4 1/8	4 1/2	5	7 1/4	1 1/8	2 3/8	2 1/4	—	3 3/8	0.924	148.0	129.0	
54	140J54	J	31.100	30.097	C	4 1/8	4 1/2	5	7 1/4	1 1/8	2 3/8	2 1/4	—	3 3/8	0.924	168.0	149.0	
60	140J60	J	34.440	33.438	C	4 1/8	4 1/2	5	7 1/4	1 1/8	2 3/8	2 1/4	—	3 3/8	0.924	205.0	186.0	
70	140M70	M	40.020	39.006	C1	5 1/2	6 3/4	6 3/4	9	2 3/8	2 3/8	2 1/2	1 1/2	5 3/8	0.924	301.0	264.0	
80	140M80	M	45.590	44.575	C1	5 1/2	6 3/4	6 3/4	9	2 3/8	2 3/8	2 1/2	1 1/2	5 3/8	0.924	385.0	348.0	

# No. 140

## 1 3/4" Pitch

# All Steel Stock Sprockets

# Martin

### Single - Taper Bushed with Hardened Teeth

No. Teeth	Catalog Number
12	140BTB12 H
13	140BTB13 H
14	140BTB14 H
15	140BTB15 H
16	140BTB16 H
17	140BTB17 H
18	140BTB18 H
19	140BTB19 H
21	140BTB21 H
26	140BTB26 H

**SABER  
TOOTH®**

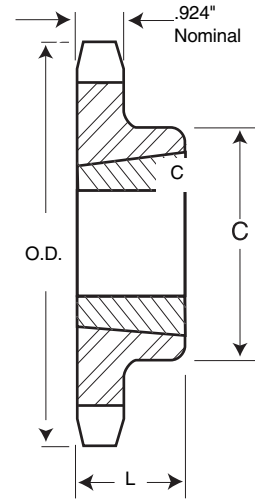

**TYPE B**

### Single - Taper Bushed

No. Teeth	Catalog Number	Bushing	Diameter		Max. Bore	Dimensions		Type	Weight Lbs. (Approx.)	
			Outside Diameter	Pitch Diameter		L	C		Rim Only	Bushing Only
12	140BTB12	2517	7.581	6.762	2 1/2	1 1/4	4 1/4	B	7.0	3.5
13	140BTB13	3020	8.150	7.313	3	2	5 1/4	B	8.0	6.5
14	140BTB14	3020	8.718	7.864	3	2	5 1/4	B	10.0	6.5
15	140BTB15	3020	9.283	8.417	3	2	5 1/4	B	12.0	6.5
16	140BTB16	3020	9.848	8.970	3	2	5 1/4	B	14.0	6.5
17	140BTB17	3020	10.411	9.524	3	2	5 1/4	B	16.0	6.5
18	140BTB18	3020	10.975	10.078	3	2	5 1/4	B	18.0	6.5
19	140BTB19	3020	11.537	10.632	3	2	5 1/4	B	20.0	6.5
21	140BTB21	3020	12.660	11.742	3	2	5 1/4	B	24.0	6.5
26	140BTB26	3020	15.463	14.518	3	2	5 1/4	B	40.0	6.5
35	140CTB35	3535	20.494	19.523	3 1/2	3 1/2	6 1/2	C	78.0	14.0
45	140CTB45	4040	26.076	25.087	4	4	7 3/4	C	118.0	22.0
60	140CTB60	4040	34.442	33.438	4	4	7 3/4	C	188.0	22.0
70	140CTB70	4040	40.017	39.006	4	4	7 3/4	C	241.0	22.0

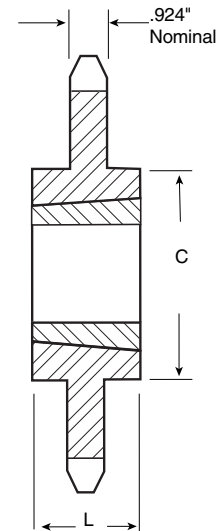

**TYPE C**

### Double Single - Type A — Steel

No. Teeth	Catalog Number	Diameters		Type	Min. Bore	Max. Bore	Dimensions				Wt. Lbs. (Approx.)
		Outside Diameter	Pitch Diameter				L	C	E	w Nom.	
14	DS140A14	8.720	7.864	A	1 1/16	3 3/8	3 39/64	2 11/16	5 1/8	0.924	35.0
15	DS140A15	9.280	8.417	A	1 1/16	4 1/16	3 39/64	2 11/16	6 29/64	0.924	43.0
16	DS140A16	9.850	8.970	A	1 1/16	5 1/4	3 39/64	2 11/16	7 1/4	0.924	49.0
17	DS140A17	10.410	9.524	A	1 1/16	5 3/8	3 39/64	2 11/16	7 37/64	0.924	58.0
18	DS140A18	10.980	10.078	A	1 1/16	6 1/8	3 39/64	2 11/16	8 3/4	0.924	66.0

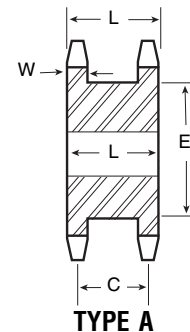

**TYPE A**

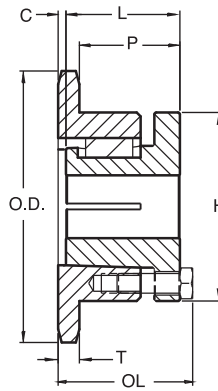

**TYPE 4**

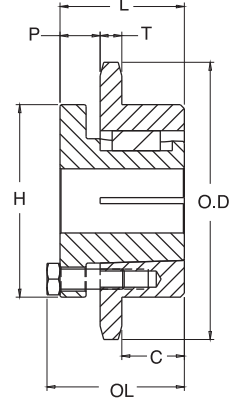

**TYPE 5**

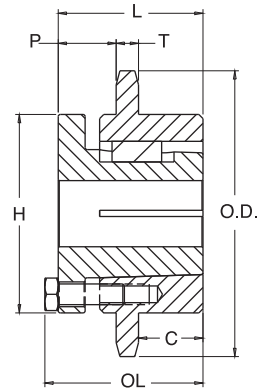

**TYPE 6**

### Single - MST<sup>®</sup> Sprockets

No. Teeth	Catalog Number	Bush-ing	Diameters		Type	Max. Bore	Dimensions						Weight Lbs. (Approx.)	
			Outside Dia.	Pitch Dia.			OL	L	C	H	P	T(nom)	With Hub	Rim Only
11	140Q11H	Q1	7.010	6.212	4	2-11/16	2-25/32	2-1/2	—	4-1/8	1-9/16	0.924	9.9	6.4
12	140Q12H	Q1	7.580	6.762	4	2-11/16	2-25/32	2-1/2	—	4-1/8	1-9/16	0.924	12.5	9.0
13	140R13H	R1	8.150	7.313	4	3-3/4	3-5/32	2-7/8	—	5-3/8	1-15/16	0.924	18.6	11.1
14	140R14H	R1	8.720	7.864	4	3-3/4	3-5/32	2-7/8	—	5-3/8	1-15/16	0.924	20.1	12.6
15	140R15H	R1	9.280	8.417	4	3-3/4	3-5/32	2-7/8	—	5-3/8	1-1/16	0.924	22.2	14.7
16	140R16H	R1	9.850	8.970	4	3-3/4	3-5/32	2-7/8	—	5-3/8	1-1/16	0.924	24.0	16.5
17	140R17H	R1	10.410	9.524	4	3-3/4	3-5/32	2-7/8	—	5-3/8	1-15/16	0.924	26.0	18.5
18	140R18H	R1	10.980	10.078	4	3-3/4	3-5/32	2-7/8	—	5-3/8	1-15/16	0.924	28.0	20.5
19	140R19H	R1	11.540	10.632	4	3-3/4	3-5/32	2-7/8	—	5-3/8	1-15/16	0.924	30.5	23.0
20	140R20H	R1	12.100	11.187	4	3-3/4	3-5/32	2-7/8	—	5-3/8	1-15/16	0.924	32.9	25.4
21	140R21H	R1	12.660	11.742	4	3-3/4	3-5/32	2-7/8	—	5-3/8	1-15/16	0.924	35.3	27.8
22	140R22H	R1	13.220	12.297	5	3-3/4	3-5/32	2-7/8	1-1/16	5-3/8	7/8	0.924	40.0	32.5
23	140R23H	R1	13.780	12.852	5	3-3/4	3-5/32	2-7/8	1-1/16	5-3/8	7/8	0.924	43.5	36.0
24	140R24H	R1	14.340	13.407	5	3-3/4	3-5/32	2-7/8	1-1/16	5-3/8	7/8	0.924	45.1	37.6
25	140R25H	R1	14.900	13.963	5	3-3/4	3-5/32	2-7/8	1-1/16	5-3/8	7/8	0.924	47.8	40.3
26	140R26H	R1	15.460	14.518	5	3-3/4	3-5/32	2-7/8	1-1/16	5-3/8	7/8	0.924	51.5	44.0
30	140R30H	R2	17.700	16.742	5	3-5/8	5-5/32	4-7/8	2	5-3/8	7/8	0.924	79.0	68.0
35	140R35	R2	20.490	19.523	6	3-5/8	5-5/32	4-7/8	2	5-3/8	7/8	0.924	99.0	88.0
36	140R36	R2	21.050	20.079	6	3-5/8	5-5/32	4-7/8	2	5-3/8	7/8	0.924	101.0	90.0
36	140S36	S1	21.050	20.079	5	4-1/4	43/4	4-3/8	2-3/8	6-3/8	1-1/16	0.924	102.5	89.0
40	140R40	R2	23.290	22.305	6	3-5/8	5-5/32	4-7/8	2	5-3/8	7/8	0.924	120.0	109.0
40	140S40	S1	23.290	22.305	5	4-1/4	4-3/4	4-3/8	2-3/8	6-3/8	1-1/16	0.924	120.5	107.0
45	140S45	S1	26.080	25.087	5	4-1/4	4-3/4	43/8	2-3/8	6-3/8	1-1/16	0.924	145.5	132.0
48	140S48	S2	27.750	26.757	6	4-3/16	7-1/2	6-3/4	2-7/8	6-3/8	2-15/16	0.924	188.0	169.0
54	140S54	S2	31.100	30.097	6	4-3/16	7-1/2	6-3/4	2-7/8	6-3/8	2-15/16	0.924	227.0	208.0
60	140S60	S2	34.440	33.438	6	4-3/16	7-1/2	6-3/4	2-7/8	6-3/8	2-15/16	0.924	249.0	230.0
70	140S70	S2	40.020	39.006	6	4-3/16	7-1/2	6-3/4	2-7/8	6-3/8	2-15/16	0.924	330.0	311.0
80	140S80	S2	45.590	44.575	6	4-3/16	7-1/2	6-3/4	2-7/8	6-3/8	2-15/16	0.924	261.0	242.0

Sprockets with "H" suffix have hardened teeth.

# No. 140-2

## 1 3/4" Pitch

# All Steel Stock Sprockets

# Martin

### Double - Type B & C

No. Teeth	Catalog Number	Outside Diameter	Type	Bore (inches)		Hub (inches)		Weight Lbs. (Approx.)
				Stock	Rec. Max.	Dia.	Length Thru	
13	D140B13	8.150	B	1 1/8	3 5/16	5	3 3/4	29.0
14	D140B14	8.720	B	1 1/8	3 3/8	5 1/2	3 3/4	34.8
15	D140B15	9.280	B	1 1/8	4 1/2	6 1/2	3 3/4	42.5
16	D140B16	9.850	B	1 1/8	5 1/4	7	4	48.1
17	D140B17	10.410	B	1 1/8	5 1/4	7	4	57.5
18	D140B18	10.980	B	1 1/8	5 1/4	7	4	65.6
19	D140B19	11.540	B	1 1/8	5 1/4	7	4	72.0
20	D140B20	12.100	B	1 1/8	5 1/4	7	4	76.0
21	D140B21	12.660	B	1 1/8	5 1/4	7	4	82.0
22	D140B22	13.220	B	1 1/8	5 1/4	7	4	94.0
23	D140B23	13.780	B	1 1/8	5 1/4	7	4	100.0
24	D140B24	14.340	B	1 1/8	5 1/4	7	4	104.0
25	D140B25	14.900	B	1 1/8	5 1/4	7	4	120.0
26	D140B26	15.460	B	1 1/8	5 1/4	7	4	128.0
35	D140C35	20.490	C	1 1/2	5 3/8	7 1/2	6	180.0
45	D140C45	26.080	C	1 1/2	5 3/8	7 1/2	6	232.0
60	D140C60	34.440	C	1 1/2	6 3/8	9 1/2	6 1/4	372.0

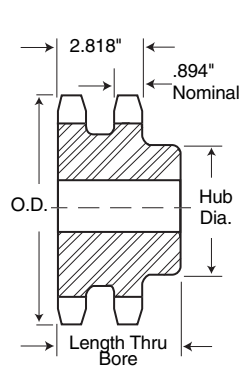

TYPE B

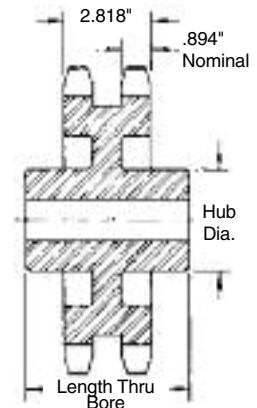

TYPE C

Maximum bores shown will accommodate standard keyseat and setscrew over keyseat. Slightly larger bores are possible with no keyseat, shallow keyseat, or setscrew at angle to keyseat.

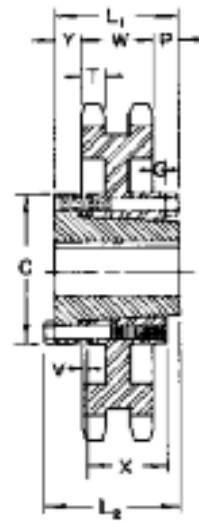

QD — TYPE C<sub>5</sub>

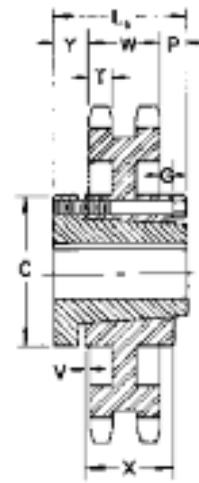

QD — TYPE C<sub>6</sub>

#### Alteration Charges

See current discount sheet for alteration charges.

### Double - Type QD

No. Teeth	Catalog Number	Bush-ing	Diameters		Type	Max. Bore	Dimensions										Weight Lbs. (Approx.)	
			Outside Diameter	Pitch Diameter			L <sub>1</sub>	L <sub>2</sub>	C	Y	P	G	V	X	T	W	With Hub	Rim Only
35	D140J35	J	20.490	19.523	C5	4 1/16	4 1/2	5	7 1/4	3 1/32	2 1/32	1 1/2	7/32	3 1/16	0.894	2.818	137	128
45	D140J45	J	26.080	25.087	C5	4 7/16	4 1/2	5	7 1/4	3 1/32	2 1/32	1 1/2	7/32	3 1/16	0.894	2.818	195	176
60	D140M60	M	34.440	33.438	C6	5 1/2	6 3/4	6 3/4	9	2 1/32	1 23/32	1 19/32	25/32	5 3/16	0.894	2.818	339	302

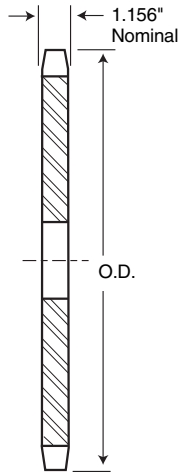

**TYPE A**



**Alteration Charges**

See current discount sheet for alteration charges.

### Single - Type B & C

### Single - Type A — Plate

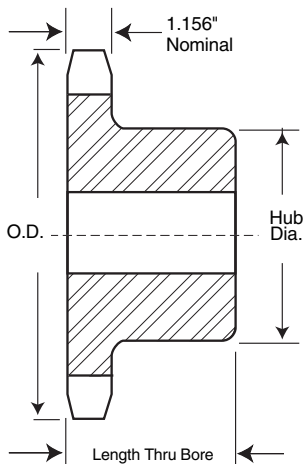

**TYPE B**

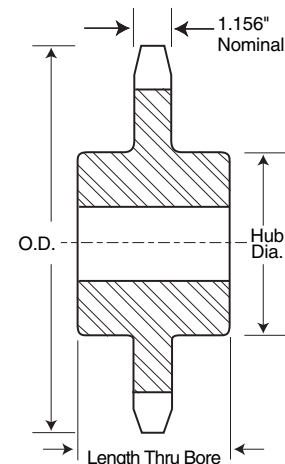

**TYPE C**

No. Teeth	Catalog Number	Outside Diameter	Type	Bore (inches)		Hub (inches)		Weight Lbs (Approx.)	Type	Catalog Number	Stock Bore	Weight Lbs. (Approx.)
				Stock	Rec. Max.	Dia.	Length Thru					
8	160B8	6.030	B	1½	1¾	3¼	2¼	8.0	A	160A8	1½	5.0
9	160B9	6.700	B	1½	2¾	3¾	2¼	10.0	A	160A9	1½	7.0
10	160B10	7.360	B	1½	2¾	4¼	2¼	12.0	A	160A10	1½	8.0
11	160B11	8.010	B	1½	3¾	4¼	2½	17.0	A	160A11	1½	10.0
12	160B12	8.660	B	1½	3¾	5½	2½	21.0	A	160A12	1½	12.0
13	160B13	9.310	B	1½	4	6	2¾	28.0	A	160A13	1½	16.0
14	160B14	9.960	B	1½	4¾	6¾	2¾	32.0	A	160A14	1½	17.0
15	160B15	10.610	B	1½	5¼	7	2¾	37.0	A	160A15	1½	21.0
16	160B16	11.260	B	1½	5¼	7	2¾	41.0	A	160A16	1½	24.0
17	160B17	11.900	B	1½	5¼	7	2¾	45.0	A	160A17	1½	27.0
18	160B18	12.540	B	1½	5¼	7	2¾	48.0	A	160A18	1½	30.0
19	160B19	13.190	B	1½	5¼	7	2¾	52.0	A	160A19	1½	34.0
20	160B20	13.830	B	1½	5¼	7	2¾	56.0	A	160A20	1½	38.0
21	160B21	14.470	B	1½	5¼	7	2¾	59.0	A	160A21	1½	42.0
22	160B22	15.110	B	1½	5¼	7	2¾	65.0	A	160A22	1½	46.0
23	160B23	15.750	B	1½	5¼	7	2¾	68.0	A	160A23	1½	50.0
24	160B24	16.390	B	1½	5¼	7	3	77.0	A	160A24	1½	56.0
25	160B25	17.030	B	1½	5¼	7	3	81.0	A	160A25	1½	61.0
26	160B26	17.670	B	1½	5¼	7	3	86.0	A	160A26	1½	65.0
27	160B27	18.310	B	1½	5¼	7	3	91.0	A	160A27	1½	71.0
28	160B28	18.950	B	1½	5¼	7	3	98.0	A	160A28	1½	77.0
30	160B30	20.230	B	1½	5¼	7	3	108.0	A	160A30	1½	90.0
35	160C35	23.420	C	1½	5¾	8	4½	154.0	A	160A35	1½	121.0
40	160C40	26.610	C	1½	5¾	8	4½	196.0	A	160A40	1½	138.0
45	160C45	29.800	C	1½	5¾	8	5	234.0	A	160A45	1½	204.0
54	160C54	35.540	C	1½	5¾	8	5	276.0	A	160A54	1½	294.0
60	160C60	39.360	C	1½	5¾	8	5	329.0	A	160A60	1½	366.0
70	160C70	45.730	C	1½	5¾	8	5	446.0	A	160A70	1½	507.0
80	160C80	52.100	C	1½	5¾	8	6	612.0	A	160A80	1½	656.0

### Single - Type C — Steel 2" Pitch

No. Teeth	Catalog Number	Outside Diameter	Bore (inches)		Hub (inches)		Weight Lbs. (Approx.)
			Stock	Rec. Max.	Diameter	Length	
11	160C11	8.010	1½"	3¼"	4½"	4¾"	21.0
12	160C12	8.660	1½"	3¾"	5½"	4¾"	26.0

Maximum bores shown will accommodate standard keyseat and setscrew over keyseat. Slightly larger bores are possible with no keyseat, shallow keyseat, or setscrew at angle to keyseat.

# No. 160 2" Pitch

# All Steel Stock Sprockets

# Martin

## Single - Type QD With Hardened Teeth

No. Teeth	Catalog Number
12	160E12 H
13	160E13 H
14	160E14 H
15	160F15 H
16	160F16 H
17	160F17 H
18	160F18 H
19	160F19 H
20	160F20 H
21	160F21 H
22	160F22 H
23	160F23 H
24	160F24 H
25	160F25 H
26	160J26 H
28	160J28 H
30	160J30 H

**SABER  
TOOTH®**

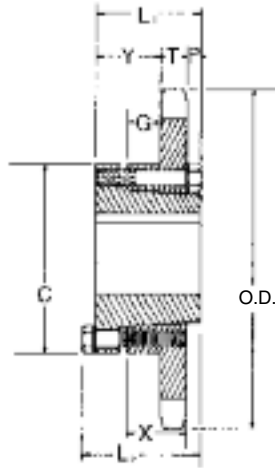

QD — TYPE B,

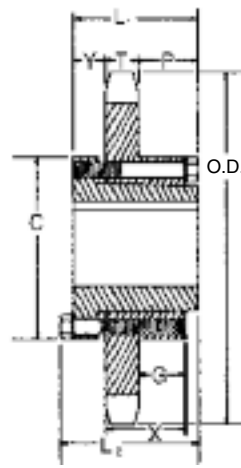

QD — TYPE C

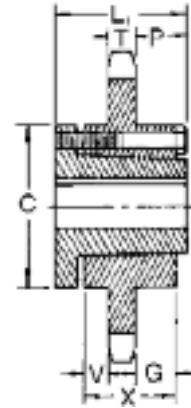

QD — TYPE C<sub>1</sub>



## Single - Type QD

No. Teeth	Catalog Number	Bushing	Diameters		Type	Max. Bore	Dimensions								Weight Lbs. (Approx.)		
			Outside Diameter	Pitch Diameter			L <sub>1</sub>	L <sub>2</sub>	C	Y	P	G	V	X	T	With Hub	Rim Only
12	160E12	E	8.660	7.727	B1	3½	2%	2 <sup>15</sup> / <sub>16</sub>	6	1 <sup>1</sup> / <sub>16</sub>	½	1 <sup>15</sup> / <sub>32</sub>	—	1%	1.156	21.0	11.0
13	160E13	E	9.310	8.357	B1	3½	2%	2 <sup>15</sup> / <sub>16</sub>	6	1 <sup>1</sup> / <sub>16</sub>	½	1 <sup>15</sup> / <sub>32</sub>	—	1%	1.156	24.0	14.0
14	160E14	E	9.960	8.988	B1	3½	2%	2 <sup>15</sup> / <sub>16</sub>	6	1 <sup>1</sup> / <sub>16</sub>	½	1 <sup>15</sup> / <sub>32</sub>	—	1%	1.156	26.0	16.0
15	160F15	F	10.610	9.620	B1	3 <sup>15</sup> / <sub>16</sub>	3%	4	6%	2 <sup>1</sup> / <sub>16</sub>	½	1 <sup>11</sup> / <sub>32</sub>	—	2½	1.156	35.5	24.0
16	160F16	F	11.260	10.252	B1	3 <sup>15</sup> / <sub>16</sub>	3%	4	6%	2 <sup>1</sup> / <sub>16</sub>	½	1 <sup>11</sup> / <sub>32</sub>	—	2½	1.156	38.5	27.0
17	160F17	F	11.900	10.885	B1	3 <sup>15</sup> / <sub>16</sub>	3%	4	6%	2 <sup>1</sup> / <sub>16</sub>	½	1 <sup>11</sup> / <sub>32</sub>	—	2½	1.156	42.5	31.0
18	160F18	F	12.540	11.518	B1	3 <sup>15</sup> / <sub>16</sub>	3%	4	6%	2 <sup>1</sup> / <sub>16</sub>	½	1 <sup>11</sup> / <sub>32</sub>	—	2½	1.156	46.5	35.0
19	160F19	F	13.190	12.151	B1	3 <sup>15</sup> / <sub>16</sub>	3%	4	6%	2 <sup>1</sup> / <sub>16</sub>	½	1 <sup>11</sup> / <sub>32</sub>	—	2½	1.156	49.5	38.0
20	160F20	F	13.830	12.785	B1	3 <sup>15</sup> / <sub>16</sub>	3%	4	6%	2 <sup>1</sup> / <sub>16</sub>	½	1 <sup>11</sup> / <sub>32</sub>	—	2½	1.156	53.5	42.0
21	160F21	F	14.740	13.419	B1	3 <sup>15</sup> / <sub>16</sub>	3%	4	6%	2 <sup>1</sup> / <sub>16</sub>	½	1 <sup>11</sup> / <sub>32</sub>	—	2½	1.156	56.5	45.0
22	160F22	F	15.110	14.053	B1	3 <sup>15</sup> / <sub>16</sub>	3%	4	6%	2 <sup>1</sup> / <sub>16</sub>	½	1 <sup>11</sup> / <sub>32</sub>	—	2½	1.156	62.5	51.0
23	160F23	F	15.750	14.688	B1	3 <sup>15</sup> / <sub>16</sub>	3%	4	6%	2 <sup>1</sup> / <sub>16</sub>	½	1 <sup>11</sup> / <sub>32</sub>	—	2½	1.156	66.5	55.0
24	160F24	F	16.390	15.323	B1	3 <sup>15</sup> / <sub>16</sub>	3%	4	6%	2 <sup>1</sup> / <sub>16</sub>	½	1 <sup>11</sup> / <sub>32</sub>	—	2½	1.156	70.5	59.0
25	160F25	F	17.030	15.958	B1	3 <sup>15</sup> / <sub>16</sub>	3%	4	6%	2 <sup>1</sup> / <sub>16</sub>	½	1 <sup>11</sup> / <sub>32</sub>	—	2½	1.156	75.5	64.0
26	160J26	J	17.670	16.593	C	4%	4½	5	7¼	1 <sup>1</sup> / <sub>16</sub>	2½	2 <sup>1</sup> / <sub>32</sub>	—	3 <sup>3</sup> / <sub>16</sub>	1.156	92.5	74.0
28	160J28	J	18.950	17.863	C	4%	4½	5	7¼	1 <sup>1</sup> / <sub>16</sub>	2½	2 <sup>1</sup> / <sub>32</sub>	—	3 <sup>3</sup> / <sub>16</sub>	1.156	103.0	84.0
30	160J30	J	20.230	19.134	C	4%	4½	5	7¼	1 <sup>1</sup> / <sub>16</sub>	2½	2 <sup>1</sup> / <sub>32</sub>	—	3 <sup>3</sup> / <sub>16</sub>	1.156	115.0	96.0
35	160J35	J	23.420	22.312	C	4%	4½	5	7¼	1 <sup>1</sup> / <sub>16</sub>	2½	2 <sup>1</sup> / <sub>32</sub>	—	3 <sup>3</sup> / <sub>16</sub>	1.156	135.0	116.0
40	160M40	M	26.610	25.491	C1	5%	6%	6%	9	2 <sup>1</sup> / <sub>16</sub>	2 <sup>1</sup> / <sub>16</sub>	2 <sup>1</sup> / <sub>32</sub>	1 <sup>1</sup> / <sub>32</sub>	5 <sup>1</sup> / <sub>16</sub>	1.156	21.0	174.0
45	160M45	M	29.800	28.671	C1	5%	6%	6%	9	2 <sup>1</sup> / <sub>16</sub>	2 <sup>1</sup> / <sub>16</sub>	2 <sup>1</sup> / <sub>32</sub>	1 <sup>1</sup> / <sub>32</sub>	5 <sup>1</sup> / <sub>16</sub>	1.156	245.0	208.0
54	160M54	M	35.540	34.397	C1	5%	6%	6%	9	2 <sup>1</sup> / <sub>16</sub>	2 <sup>1</sup> / <sub>16</sub>	2 <sup>1</sup> / <sub>32</sub>	1 <sup>1</sup> / <sub>32</sub>	5 <sup>1</sup> / <sub>16</sub>	1.156	299.0	262.0
60	160M60	M	39.360	38.215	C1	5%	6%	6%	9	2 <sup>1</sup> / <sub>16</sub>	2 <sup>1</sup> / <sub>16</sub>	2 <sup>1</sup> / <sub>32</sub>	1 <sup>1</sup> / <sub>32</sub>	5 <sup>1</sup> / <sub>16</sub>	1.156	347.0	310.0
70	160M70	M	45.730	44.578	C1	5%	6%	6%	9	2 <sup>1</sup> / <sub>16</sub>	2 <sup>1</sup> / <sub>16</sub>	2 <sup>1</sup> / <sub>32</sub>	1 <sup>1</sup> / <sub>32</sub>	5 <sup>1</sup> / <sub>16</sub>	1.156	468.0	431.0
80	160M80	M	52.100	50.943	C1	5%	6%	6%	9	2 <sup>1</sup> / <sub>16</sub>	2 <sup>1</sup> / <sub>16</sub>	2 <sup>1</sup> / <sub>32</sub>	1 <sup>1</sup> / <sub>32</sub>	5 <sup>1</sup> / <sub>16</sub>	1.156	567.0	530.0



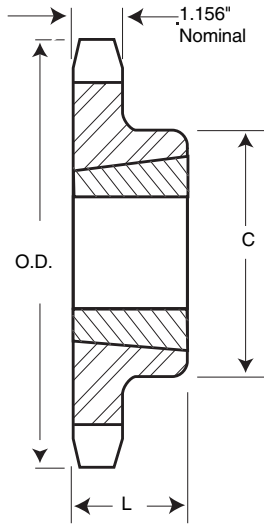

### Single - Taper Bushed with Hardened Teeth



**SABER  
TOOTH®**

No. Teeth	Catalog Number
11	160BTB11H
12	160BTB12H
13	160BTB13H
14	160BTB14H
15	160BTB15H
16	160BTB16H
17	160BTB17H
18	160BTB18H
19	160BTB19H
21	160BTB21H
26	160BTB26H

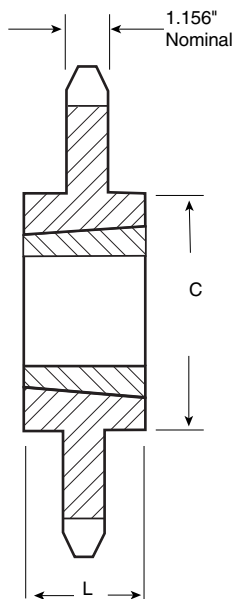

### Single - Taper Bushed

No. Teeth	Catalog Number	Bushing	Diameter		Max. Bore	Dimensions		Type	Weight Lbs. (Approx.)	
			Outside Diameter	Pitch Diameter		L	C		Rim Only	Bushing Only
11	160BTB11	2517	8.011	7.099	2½	1¾	4¾	B	9.0	3.5
12	160BTB12	3020	8.664	7.727	3	2	5¼	B	11.0	6.5
13	160BTB13	3020	9.314	8.357	3	2	5¼	B	13.0	6.5
14	160BTB14	3020	9.963	8.988	3	2	5¼	B	16.0	6.5
15	160BTB15	3535	10.609	9.620	3½	3½	6½	B	25.0	14.0
16	160BTB16	3535	11.255	10.252	3½	3½	6½	B	28.0	14.0
17	160BTB17	3535	11.899	10.885	3½	3½	6½	B	32.0	14.0
18	160BTB18	3535	12.543	11.518	3½	3½	6½	B	35.0	14.0
19	160BTB19	3535	13.185	12.151	3½	3½	6½	B	39.0	14.0
21	160BTB21	3535	14.470	13.419	3½	3½	6½	B	48.0	14.0
26	160BTB26	3535	17.671	16.593	3½	3½	6½	B	68.0	14.0
35	160CTB35	4040	23.422	22.312	4	4	7¾	C	118.0	14.0
45	160CTB45	4040	29.802	28.671	4	4	7¾	C	186.0	22.0
60	160CTB60	4545	39.362	38.215	4½	4½	8¾	C	292.0	30.0

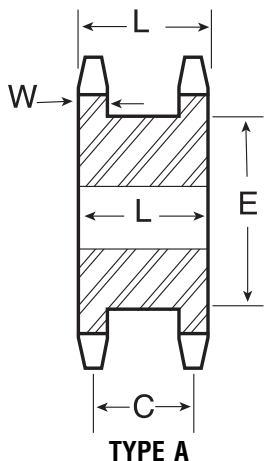

### Double Single - Type A — Steel

No. Teeth	Catalog Number	Diameters		Type	Min. Bore	Max. Bore	Dimensions			Wt. Lbs. (Approx.)	
		Outside Diameter	Pitch Diameter				L	C	E		
15	DS160A15	10.609	9.620	A	1 11/16	5 1/2	4 1/4	3 3/8	7 3/8	1.156	69.0
16	DS160A16	11.255	10.252	A	1 11/16	6	4 1/4	3 3/8	8 1/4	1.156	75.0
17	DS160A17	11.899	10.885	A	1 11/16	6 1/2	4 1/4	3 3/8	8 21/32	1.156	92.0
18	DS160A18	12.543	11.518	A	1 11/16	6 9/16	4 1/4	3 3/8	9 9/16	1.156	97.0

# No. 160

## 2" Pitch

# MST® Sprockets

# Martin

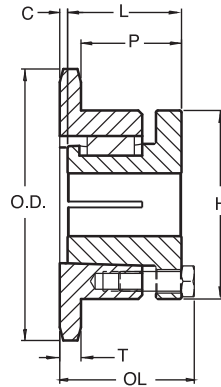

**TYPE 4**

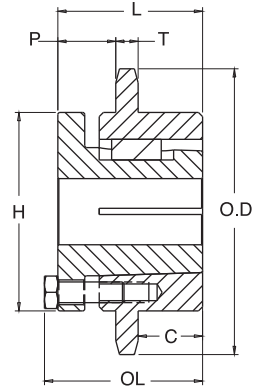

**TYPE 6**

### Single - MST® Sprockets

No. Teeth	Catalog Number	Bush-ing	Diameters		Type	Max. Bore	Dimensions						Weight Lbs. (Approx.)	
			Outside Dia.	Pitch Dia.			OL	L	C	H	P	T(nom)	With Hub	Rim Only
11	160R11H	R1	8.010	7.099	4	3-3/4	3-13/32	2-7/8	1/4	5-3/8	1-31/32	1.156	18.3	10.8
12	160R12H	R1	8.660	7.727	4	3-3/4	3-13/32	2-7/8	1/4	5-3/8	1-31/32	1.156	21.7	14.2
13	160R13H	R1	9.310	8.357	4	3-3/4	3-5/32	2-7/8	—	5-3/8	1-23/32	1.156	23.0	15.5
14	160R14H	R1	9.960	8.988	4	3-3/4	3-5/32	2-7/8	—	5-3/8	1-23/32	1.156	26.0	18.5
15	160R15H	R1	10.610	9.620	4	3-3/4	3-5/32	2-7/8	—	5-3/8	1-23/32	1.156	29.1	21.6
16	160R16H	R1	11.260	10.252	4	3-3/4	3-5/32	2-7/8	—	5-3/8	1-23/32	1.156	32.5	25.0
17	160R17H	R1	11.900	10.885	4	3-3/4	3-5/32	2-7/8	—	5-3/8	1-23/32	1.156	35.5	28.0
18	160R18H	R1	12.540	11.518	4	3-3/4	3-5/32	2-7/8	—	5-3/8	1-23/32	1.156	39.4	31.9
19	160R19H	R1	13.190	12.151	4	3-3/4	3-5/32	2-7/8	—	5-3/8	1-23/32	1.156	43.4	35.9
20	160R20H	R2	13.830	12.785	6	3-5/8	5-5/32	4-7/8	2	5-3/8	1-23/32	1.156	62.0	51.0
21	160R21H	R2	14.470	13.419	6	3-5/8	5-5/32	4-7/8	2	5-3/8	1-23/32	1.156	67.0	56.0
22	160R22H	R2	15.110	14.053	6	3-5/8	5-5/32	4-7/8	2	5-3/8	1-23/32	1.156	71.0	60.0
23	160R23H	R2	15.750	14.688	6	3-5/8	5-5/32	4-7/8	2	5-3/8	1-23/32	1.156	76.0	65.0
24	160R24H	R2	16.390	15.323	6	3-5/8	5-5/32	4-7/8	2	5-3/8	1-23/32	1.156	82.5	71.5
25	160R25H	R2	17.030	15.958	6	3-5/8	5-5/32	4-7/8	2	5-3/8	1-23/32	1.156	85.0	74.0
26	160R26H	R2	17.670	16.593	6	3-5/8	5-5/32	4-7/8	2	5-3/8	1-23/32	1.156	90.0	79.0
26	160S26H	S2	17.670	16.593	6	4-3/16	7-1/8	6-3/4	2-7/8	6-3/8	2-23/32	1.156	98.0	79.0
28	160R28H	R2	18.950	17.863	6	3-5/8	5-5/32	4-7/8	2	5-3/8	1-23/32	1.156	110.8	99.8
28	160S28H	S2	19.950	17.863	6	4-3/16	7-1/8	6-3/4	2-7/8	6-3/8	2-23/32	1.156	118.8	99.8
30	160R30H	R2	20.230	19.134	6	3-5/8	5-5/32	4-7/8	2	5-3/8	1-23/32	1.156	117.0	106.0
30	160S30H	S2	20.230	19.134	6	4-3/16	7-1/8	6-3/4	2-7/8	6-3/8	2-23/32	1.156	134.0	115.0
35	160S35	S2	23.420	22.312	6	4-3/16	7-1/8	6-3/4	2-7/8	6-3/8	2-23/32	1.156	169.0	150.0
40	160S40	S2	26.610	25.491	6	4-3/16	7-1/8	6-3/4	2-7/8	6-3/8	2-23/32	1.156	184.0	165.0
45	160S45	S2	29.800	28.671	6	4-3/16	7-1/8	6-3/4	2-7/8	6-3/8	2-23/32	1.156	223.0	204.0
60	160U60	U0	39.360	38.215	6	5-1/2	5 25/32	5-1/4	1-15/16	8-3/8	1-21/32	1.156	338.0	308.0
70	160U70	U0	45.730	44.578	6	5-1/2	5 25/32	5-1/4	1-15/16	8-3/8	1-21/32	1.156	384.0	354.0
80	160S80	S2	52.100	50.943	6	4-3/16	7-1/8	6-3/4	2-7/8	6-3/8	2-23/32	1.156	—	—
80	160U80	U1	52.100	50.943	6	5-1/2	7-19/32	7-1/8	2-7/8	8-3/8	2 19/32	1.156	434.0	394.0

Sprockets with "H" suffix have hardened teeth.

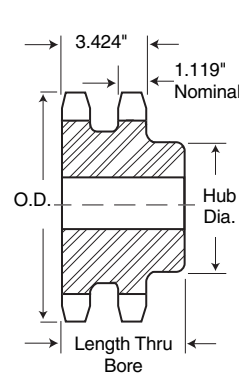

TYPE B

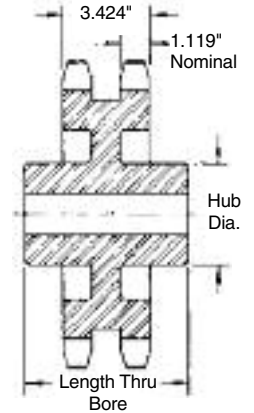

TYPE C

### Alteration Charges

See current discount sheet for alteration charges.

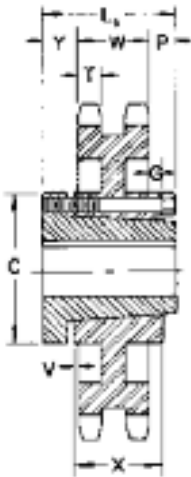

QD — TYPE C<sub>6</sub>

### Double - Type B & C

No. Teeth	Catalog Number	Outside Diameter	Type	Bore (inches)		Hub (inches)		Weight Lbs. (App.)
				Stock	Rec. Max.	Dia.	Length Thru	
13	D160B13	9.310	B	2	4	6	4%	48
14	D160B14	9.960	B	2	4%	6%	4%	58
15	D160B15	10.610	B	2	5%	7	4%	68
16	D160B16	11.260	B	2	5%	7	4%	75
17	D160B17	11.900	B	2	5%	7	4%	91
18	D160B18	12.540	B	2	5%	7	4%	96
19	D160B19	13.190	B	2	5%	7	4%	107
20	D160B20	13.830	B	2	5%	7	4%	119
21	D160B21	14.470	B	2	5%	7½	4%	130
22	D160B22	15.110	B	2	5%	7½	4%	141
23	D160B23	15.750	B	2	5%	7½	4%	157
24	D160B24	16.390	B	2	5%	7½	4%	171
25	D160B25	17.030	B	2	5%	7½	4%	187
26	D160B26	17.670	B	2	5%	7½	4%	201
35	D160C35	23.420	C	1½	6%	9½	6%	306
45	D160C45	29.800	C	1½	7	10	7%	431
60	D160C60	39.360	C	1½	7	10	7%	564

Maximum bores shown will accommodate standard keyseat and setscrew over keyseat. Slightly larger bores are possible with no keyseat, shallow keyseat, or setscrew at angle to keyseat.

### Double - Type QD

No. Teeth	Catalog Number	Bush-ing	Diameters		Type	Max. Bore	Dimensions										Weight Lbs. (Approx.)	
			Outside Diameter	Pitch Diameter			L <sub>1</sub>	L <sub>2</sub>	C	Y	P	G	V	X	T	W	With Hub	Rim Only
35	D160M35	M	23.420	22.312	C6	5½	6%	6%	9	2 <sup>11</sup> / <sub>64</sub>	1 <sup>1</sup> / <sub>32</sub>	1 <sup>1</sup> / <sub>32</sub>	3 <sup>39</sup> / <sub>64</sub>	5 <sup>5</sup> / <sub>16</sub>	1.119	3.424	259	222
45	D160N45	N	29.800	28.671	C6	6	8%	8%	10	2 <sup>11</sup> / <sub>64</sub>	2 <sup>2</sup> / <sub>64</sub>	2 <sup>2</sup> / <sub>64</sub>	2 <sup>21</sup> / <sub>64</sub>	6%	1.119	3.424	377	340
60	D160N60	N	39.360	38.215	C6	6	8%	8%	10	2 <sup>11</sup> / <sub>64</sub>	2 <sup>23</sup> / <sub>64</sub>	2 <sup>2</sup> / <sub>64</sub>	2 <sup>21</sup> / <sub>64</sub>	6%	1.119	3.424	509	472

# No. 180 2 1/4" Pitch

# All Steel Stock Sprockets

# Martin

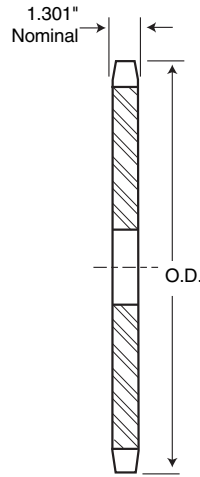

**TYPE A**

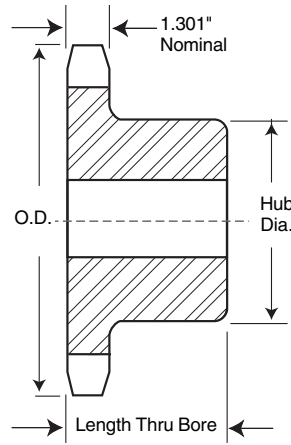

**TYPE B**

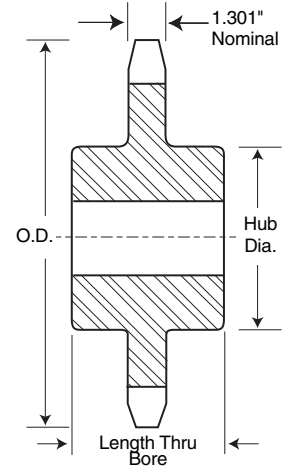

**TYPE C**

## Single - Type B & C

## Single - Type A

No. Teeth	Catalog Number	Outside Diameter	Type	Bore (inches)		Hub (inches)		Weight Lbs (Approx.)	Type	Catalog Number	Stock Bore	Weight Lbs. (Approx.)
				Stock	Rec. Max.	Dia.	Length Thru					
11	180B11	9.010	B	1 1/2	3%	5 1/2	3	29	A	180A11	1 1/2	14
12	180B12	9.750	B	1 1/2	4	6	3	32	A	180A12	1 1/2	16
13	180B13	10.480	B	1 1/2	4%	6%	3 1/2	40	A	180A13	1 1/2	20
14	180B14	11.210	B	1 1/2	5 1/4	7	3 1/2	44	A	180A14	1 1/2	24
15	180B15	11.930	B	1 1/2	5 1/4	7	3 1/2	48	A	180A15	1 1/2	28
16	180B16	12.660	B	1 1/2	5 1/4	7	3 1/2	52	A	180A16	1 1/2	32
17	180B17	13.390	B	1 1/2	5 1/4	7	3 1/2	58	A	180A17	1 1/2	37
18	180B18	14.110	B	1 1/2	5 1/4	7	3 1/2	63	A	180A18	1 1/2	43
19	180B19	14.830	B	1 1/2	5%	7 1/2	3%	74	A	180A19	1 1/2	47
20	180B20	15.560	B	1 1/2	5%	7 1/2	3%	81	A	180A20	1 1/2	53
21	180B21	16.280	B	1 1/2	5%	7 1/2	3%	83	A	180A21	1 1/2	57
22	180B22	17.000	B	1 1/2	5%	7 1/2	3%	92	A	180A22	1 1/2	62
23	180B23	17.720	B	1 1/2	5%	7 1/2	3%	99	A	180A23	1 1/2	69
24	180B24	18.440	B	1 1/2	5%	7 1/2	3%	105	A	180A24	1 1/2	77
25	180B25	19.160	B	1 1/2	5%	7 1/2	3%	113	A	180A25	1 1/2	84
28	180B28	21.320	B	1 1/2	5%	8	3 1/2	135	A	180A28	1 1/2	104
30	180C30	22.760	C	1 1/2	5%	8 1/2	4%	180	A	180A30	1 1/2	120
35	180C35	26.350	C	1 1/2	5%	8 1/2	4%	222	A	180A35	1 1/2	172
40	180C40	29.940	C	1 1/2	5%	8 1/2	4%	270	A	180A40	1 1/2	229
45	180C45	33.530	C	1 1/2	6	9	5	315	A	180A45	1 1/2	284
54	180C54	39.980	C	1 1/2	6	9	5	477	A	180A54	1 1/2	420
60	180C60	44.280	C	1 1/2	6 1/2	9 1/2	5%	489	A	180A60	1 1/2	505

### Alteration Charges

See current discount sheet for alteration charges.

Maximum bores shown will accommodate standard keyseat and setscrew over keyseat. Slightly larger bores are possible with no keyseat, shallow keyseat, or setscrew at angle to keyseat.

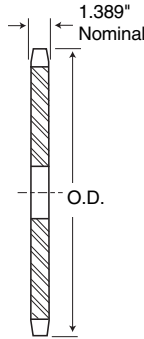

TYPE A

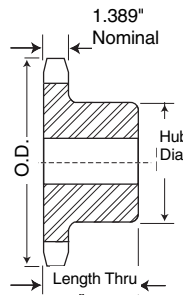

TYPE B

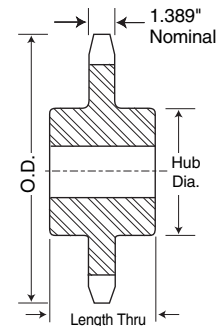

TYPE C

### Single - Type B & C

### Single - Type A

No. Teeth	Catalog Number	Outside Diameter	Type	Bore (inches)		Hub (inches)		Weight Lbs. (Approx.)	Type	Catalog Number	Stock Bore	Weight Lbs. (Approx.)
				Stock	Rec. Max.	Diameter	Length Thru					
10	200B10	9.200	B	1 1/2	3/4	5 1/2	3	26	A	200A10	1 1/2	16
11	200B11	10.020	B	1 1/2	4	6	3	33	A	200A11	1 1/2	20
12	200B12	10.830	B	1 1/2	4 1/2	6 1/2	3	37	A	200A12	1 1/2	24
13	200B13	11.640	B	1 1/2	5 1/4	7	3	46	A	200A13	1 1/2	30
14	200B14	12.460	B	1 1/2	5 3/4	7 1/2	3 1/2	59	A	200A14	1 1/2	32
15	200B15	13.260	B	1 1/2	5 3/4	7 1/2	3 1/2	64	A	200A15	1 1/2	40
16	200B16	14.070	B	1 1/2	5 3/4	7 1/2	3 1/2	72	A	200A16	1 1/2	46
17	200B17	14.870	B	1 1/2	5 3/4	7 1/2	3 1/2	76	A	200A17	1 1/2	51
18	200B18	15.680	B	1 1/2	5 3/4	7 1/2	3 1/2	84	A	200A18	1 1/2	57
19	200B19	16.480	B	1 1/2	5 3/4	7 1/2	3 1/2	91	A	200A19	1 1/2	65
20	200B20	17.290	B	1 1/2	5 3/4	7 1/2	3 1/2	98	A	200A20	1 1/2	72
21	200B21	18.090	B	1 1/2	5 3/4	7 1/2	3 1/2	106	A	200A21	1 1/2	82
22	200B22	18.890	B	1 1/2	5 3/4	8 1/2	4	131	A	200A22	1 1/2	88
23	200B23	19.690	B	1 1/2	5 3/4	8 1/2	4	136	A	200A23	1 1/2	95
24	200B24	20.490	B	1 1/2	5 3/4	8 1/2	4	142	A	200A24	1 1/2	105
25	200B25	21.290	B	1 1/2	5 3/4	8 1/2	4	153	A	200A25	1 1/2	113
26	200C26	22.090	C	1 1/2	5 3/4	8 1/2	4 1/2	178	A	200A26	1 1/2	124
28	200C28	23.690	C	1 1/2	5 3/4	8 1/2	4 1/2	195	A	200A28	1 1/2	144
30	200C30	25.290	C	1 1/2	5 3/4	8 1/2	4 1/2	212	A	200A30	1 1/2	167
32	200C32	26.880	C	1 1/2	5 3/4	8 1/2	4 1/2	220	A	200A32	1 1/2	195
35	200C35	29.280	C	1 1/2	5 3/4	8 1/2	4 1/2	254	A	200A35	1 1/2	227
40	200C40	33.270	C	1 1/2	6	9	5	320	A	200A40	1 1/2	301
45	200C45	37.250	C	1 1/2	6	9	5	364	A	200A45	1 1/2	390
54	200C54	44.420	C	1 1/2	6 1/2	9 1/2	5 1/2	512	A	200A54	1 1/2	555
60	200C60	49.200	C	1 1/2	6 1/2	9 1/2	5 1/2	654	A	200A60	1 1/2	692

**Alteration Charges**

See current discount sheet for alteration charges.

Maximum bores shown will accommodate standard keyseat and setscrew over keyseat. Slightly larger bores are possible with no keyseat, shallow keyseat, or setscrew at angle to keyseat.

### Single - Type QD

No. Teeth	Catalog Number	Bush-ing	Diameters		Type	Max. Bore	Dimensions										Weight Lbs. (Approx.)	
			Outside Dia.	Pitch Dia.			L <sub>1</sub>	L <sub>2</sub>	C	Y	P	G	V	X	T	With Hub	Rim Only	
12	200F12	F	10.830	9.660	C	3 15/16	3 3/8	4	6 3/8	1	1 1/8	1 1/8	-	2 1/2	1.389	25.5	24.0	
13	200J13	J	11.640	10.447	C	4 1/8	4 1/2	5	7 1/4	1 1/8	2	1 1/8	-	3 1/8	1.389	50.5	32.0	
14	200J14	J	12.460	11.235	C	4 1/8	4 1/2	5	7 1/4	1 1/8	2	1 1/8	-	3 1/8	1.389	57.5	39.0	
15	200J15	J	13.260	12.025	C	4 1/8	4 1/2	5	7 1/4	1 1/8	2	1 1/8	-	3 1/8	1.389	62.5	44.0	
16	200J16	J	14.070	12.815	C	4 1/8	4 1/2	5	7 1/4	1 1/8	2	1 1/8	-	3 1/8	1.389	68.5	50.0	
17	200M17	M	14.870	13.605	C1	5 1/2	6 3/8	6 3/8	9	2 3/32	2 3/32	2 3/16	1 1/2	5 3/16	1.389	113.0	76.0	
18	200M18	M	15.680	14.397	C1	5 1/2	6 3/8	6 3/8	9	2 3/32	2 3/32	2 3/16	1 1/2	5 3/16	1.389	119.0	82.0	
19	200M19	M	16.480	15.910	C1	5 1/2	6 3/8	6 3/8	9	2 3/32	2 3/32	2 3/16	1 1/2	5 3/16	1.389	125.0	88.0	
20	200M20	M	17.290	15.982	C1	5 1/2	6 3/8	6 3/8	9	2 3/32	2 3/32	2 3/16	1 1/2	5 3/16	1.389	134.0	97.0	
21	200M21	M	18.090	16.775	C1	5 1/2	6 3/8	6 3/8	9	2 3/32	2 3/32	2 3/16	1 1/2	5 3/16	1.389	140.0	103.0	
22	200M22	M	18.890	17.567	C1	5 1/2	6 3/8	6 3/8	9	2 3/32	2 3/32	2 3/16	1 1/2	5 3/16	1.389	149.0	112.0	
23	200M23	M	19.690	18.360	C1	5 1/2	6 3/8	6 3/8	9	2 3/32	2 3/32	2 3/16	1 1/2	5 3/16	1.389	157.0	120.0	
24	200M24	M	20.490	19.152	C1	5 1/2	6 3/8	6 3/8	9	2 3/32	2 3/32	2 3/16	1 1/2	5 3/16	1.389	168.0	131.0	
25	200M25	M	21.290	19.947	C1	5 1/2	6 3/8	6 3/8	9	2 3/32	2 3/32	2 3/16	1 1/2	5 3/16	1.389	175.0	138.0	
26	200M26	M	22.090	20.740	C1	5 1/2	6 3/8	6 3/8	9	2 3/32	2 3/32	2 3/16	1 1/2	5 3/16	1.389	185.0	148.0	
28	200M28	M	23.690	22.330	C1	5 1/2	6 3/8	6 3/8	9	2 3/32	2 3/32	2 3/16	1 1/2	5 3/16	1.389	205.0	168.0	
30	200M30	M	25.290	23.917	C1	5 1/2	6 3/8	6 3/8	9	2 3/32	2 3/32	2 3/16	1 1/2	5 3/16	1.389	227.0	190.0	
32	200M32	M	26.880	25.505	C1	5 1/2	6 3/8	6 3/8	9	2 3/32	2 3/32	2 3/16	1 1/2	5 3/16	1.389	251.0	214.0	
35	200M35	M	29.280	27.890	C1	5 1/2	6 3/8	6 3/8	9	2 3/32	2 3/32	2 3/16	1 1/2	5 3/16	1.389	265.0	228.0	
40	200M40	M	33.270	31.865	C1	5 1/2	6 3/8	6 3/8	9	2 3/32	2 3/32	2 3/16	1 1/2	5 3/16	1.389	315.0	278.0	
45	200N45	N	37.250	35.840	C1	5 1/2	8 1/8	8 1/8	10	3 1/32	3 1/32	3 1/16	1 1/2	6 1/4	1.389	405.0	348.0	
54	200N54	N	44.420	42.995	C1	5 1/2	8 1/8	8 1/8	10	3 1/32	3 1/32	3 1/16	1 1/2	6 1/4	1.389	535.0	478.0	
60	200N60	N	49.200	47.767	C1	5 1/2	8 1/8	8 1/8	10	3 1/32	3 1/32	3 1/16	1 1/2	6 1/4	1.389	665.0	608.0	

# No. 200

## 2 1/2" Pitch

# MST® Sprockets

# Martin

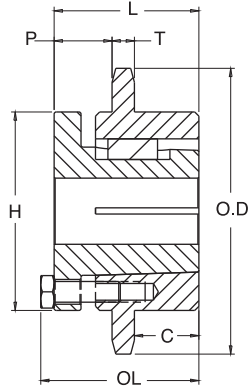

**TYPE 6**

### Single - MST® Sprockets

No. Teeth	Catalog Number	Bush-ing	Diameters		Type	Max. Bore	Dimensions						Weight Lbs. (Approx.)	
			Outside Dia.	Pitch Dia.			OL	L	C	H	P	T(nom)	With Hub	Rim Only
12	200R12	R2	10.830	9.660	6	3-5/8	5-5/32	4-7/8	2	5-3/8	1-1/2	1.389	46.3	35.3
13	200S13	S2	11.640	10.447	6	4-3/16	7-1/8	6-3/4	2-7/8	6-3/8	2-1/2	1.389	71.2	52.2
14	200S14	S2	12.460	11.235	6	4-3/16	7-1/8	6-3/4	2-7/8	6-3/8	2-1/2	1.389	76.5	57.5
15	200S15	S2	13.260	12.025	6	4-3/16	7-1/8	6-3/4	2-7/8	6-3/8	2-1/2	1.389	80.0	61.0
16	200S16	S2	14.070	12.815	6	4-3/16	7-1/8	6-3/4	2-7/8	6-3/8	2-1/2	1.389	90.0	71.0
17	200S17	S2	14.870	13.605	6	4-3/16	7-1/8	6-3/4	2-7/8	6-3/8	2-1/2	1.389	98.0	79.0
18	200U18	U0	15.680	14.397	6	5-1/2	5-23/32	5-1/4	1-5/8	8-3/8	2-17/32	1.389	106.5	76.5
19	200U19	U0	16.480	15.190	6	5-1/2	5-23/32	5-1/4	1-5/8	8-3/8	2-17/32	1.389	113.7	83.7
20	200U20	U0	17.290	15.982	6	5-1/2	5-23/32	5-1/4	1-5/8	8-3/8	2-17/32	1.389	121.3	91.3
21	200U21	U0	18.090	16.775	6	5-1/2	5-23/32	5-1/4	1-5/8	8-3/8	2-17/32	1.389	129.4	99.4
22	200U22	U0	18.890	17.567	6	5-1/2	5-23/32	5-1/4	1-5/8	8-3/8	2-17/32	1.389	140.0	110.0
23	200U23	U0	19.690	18.360	6	5-1/2	5-23/32	5-1/4	1-5/8	8-3/8	2-17/32	1.389	147.0	117.0
24	200U24	U0	20.490	19.152	6	5-1/2	5-23/32	5-1/4	1-5/8	8-3/8	2-17/32	1.389	156.0	126.0
25	200U25	U0	21.290	19.947	6	5-1/2	5-23/32	5-1/4	1-5/8	8-3/8	2-17/32	1.389	170.0	140.0
26	200U26	U0	22.090	20.740	6	5-1/2	5-23/32	5-1/4	1-5/8	8-3/8	2-17/32	1.389	180.0	150.0
28	200U28	U0	23.690	22.330	6	5-1/2	5-23/32	5-1/4	1-5/8	8-3/8	2-17/32	1.389	199.0	169.0
30	200U30	U0	25.290	23.917	6	5-1/2	5-23/32	5-1/4	1-5/8	8-3/8	2-17/32	1.389	218.0	188.0
32	200U32	U0	26.880	25.505	6	5-1/2	5-23/32	5-1/4	1-5/8	8-3/8	2-17/32	1.389	242.0	212.0
35	200U35	U1	29.280	27.890	6	5-1/2	7-19/32	7-1/8	2-7/8	8-3/8	2-7/8	1.389	292.0	252.0
40	200U40	U1	33.270	31.865	6	5-1/2	7-19/32	7-1/8	2-7/8	8-3/8	2-7/8	1.389	346.0	306.0
45	200U45	U1	37.250	35.840	6	5-1/2	7-19/32	7-1/8	2-7/8	8-3/8	2-7/8	1.389	330.0	290.0
54	200U54	U2	44.420	42.995	6	5	10-19/32	10-1/8	4-1/4	8-3/8	3-29/32	1.389	435.0	385.0
60	200U60	U2	49.200	47.767	6	5	10-19/32	10-1/8	4-1/4	8-3/8	3-29/32	1.389	495.0	445.0

Sprockets with "H" suffix have hardened teeth.

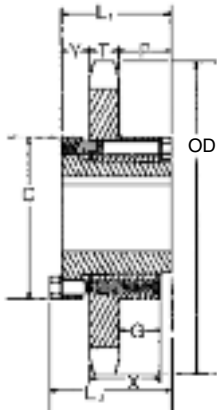

QD — TYPE C

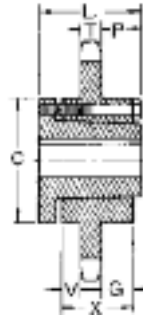

QD — TYPE C1

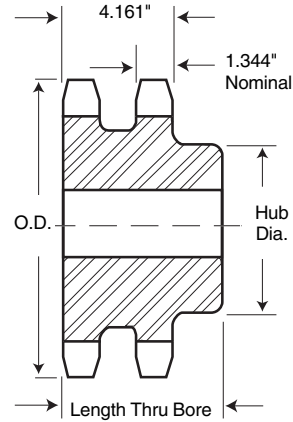

TYPE B

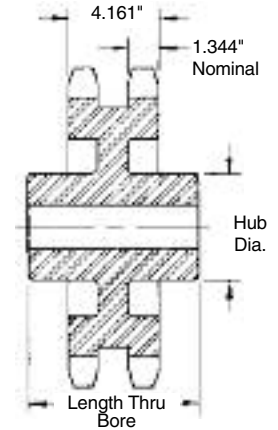

TYPE C

### Double - Type B & C



No. Teeth	Catalog Number	Outside Diameter	Type	Bore (inches)		Hub (inches)		Weight Lbs. (Approx.)
				Stock	Rec. Max.	Dia.	Length Thru	
11	D200B11	10.020	B	2	3%	5½	5%	57
12	D200B12	10.830	B	2	4½	6½	6%	80
13	D200B13	11.640	B	2	5%	7	6%	96
14	D200B14	12.460	B	2	5½	8	6%	119
15	D200B15	13.260	B	2	5%	8½	6%	138
16	D200B16	14.070	B	2	5%	8½	6%	161
17	D200B17	14.870	B	2	5%	8½	6%	178
18	D200B18	15.680	B	2	5%	8½	6%	196
19	D200B19	16.480	B	2	5%	8½	6%	217
20	D200B20	17.290	B	2	5%	8½	6%	236
21	D200B21	18.090	B	2	5%	8½	6%	250
22	D200B22	18.890	B	2	5%	8½	6%	284
23	D200B23	19.690	B	2	5%	8½	6%	308
24	D200B24	20.490	B	2	5%	8½	6%	330
25	D200B25	21.290	B	2	5%	8½	6%	358
26	D200B26	22.090	B	2	5%	8½	6%	386
45	D200C45	37.250	C	1½	7	10	8½	665
60	D200C60	49.200	C	1½	7	10	9	972

Maximum bores shown will accommodate standard keyseat and setscrew over keyseat. Slightly larger bores are possible with no keyseat, shallow keyseat, or setscrew at angle to keyseat.

#### Alteration Charges

See current discount sheet for alteration charges.

# No. 240 3" Pitch

# All Steel Stock Sprockets

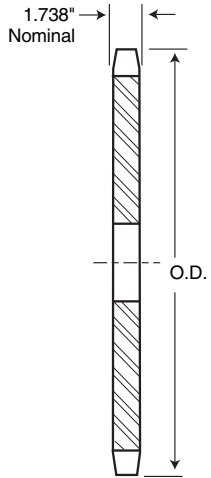

**TYPE A**

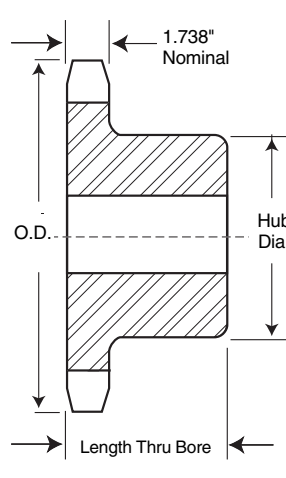

**TYPE B**

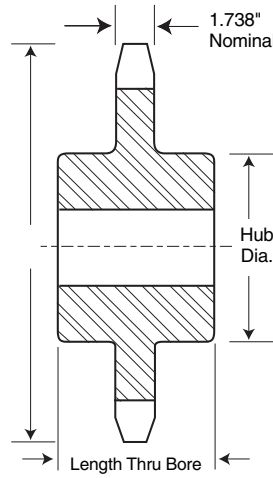

**TYPE C**



## Single - Type B & C

## Single - Type A

No. Teeth	Catalog Number	Outside Diameter	Type	Bore (inches)		Hub (inches)		Weight Lbs (Approx.)	Type	Catalog Number	Stock Bore	Weight Lbs. (Approx.)
				Stock	Rec. Max.	Dia.	Length Thru					
10	240B10	11.030	B	1½	4½	6½	3%	49.0	A	240A10	1½	30.0
11	240B11	12.020	B	1½	4%	7	3%	66.0	A	240A11	1½	37.0
12	240B12	13.000	B	1½	5%	7½	3%	72.0	A	240A12	1½	45.0
13	240B13	13.970	B	1½	5%	7½	3%	81.0	A	240A13	1½	54.0
14	240B14	14.940	B	1½	5%	7½	3%	88.0	A	240A14	1½	62.0
15	240B15	15.910	B	1½	5%	7½	3%	98.0	A	240A15	1½	68.0
16	240B16	16.880	B	1½	5%	8	4%	120.0	A	240A16	1½	82.0
17	240B17	17.850	B	1½	5%	8	4%	137.0	A	240A17	1½	93.0
18	240B18	18.810	B	1½	5½	8	4%	142.0	A	240A18	1½	108.0
19	240B19	19.780	B	1½	5½	8	4%	154.0	A	240A19	1½	120.0
20	240B20	20.740	B	1½	5½	8	4%	169.0	A	240A20	1½	128.0
21	240B21	21.710	B	1½	5½	8	4%	186.0	A	240A21	1½	148.0
25	240B25	25.550	B	1½	5½	8	4%	254.0	A	240A25	1½	208.0
30	240C30	30.340	C	1½	6	9	6%	398.0	A	240A30	1½	310.0
35	240C35	35.130	C	1½	6	9	6%	527.0	A	240A35	1½	416.0
40	240C40	39.920	C	1½	7	10	6%	672.0	A	240A40	1½	548.0
45	240C45	44.700	C	1½	7	10	6%	850.0	A	240A45	1½	702.0
54	240C54	53.310	C	1½	7	10	6%	1148.0	A	240A54	1½	1022.0
60	240C60	59.040	C	1½	7	10	6%	1419.0	A	240A60	1½	1268.0



## Metric Sprockets ISO STANDARDS

Types A - B & C Stock Sprockets



TYPE A  
SIMPLEX



TYPE B  
SIMPLEX



TYPE C  
TRIPLEX



TYPE B  
DUPLEX

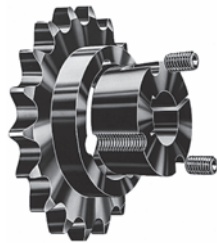

TAPER BUSHED  
SIMPLEX

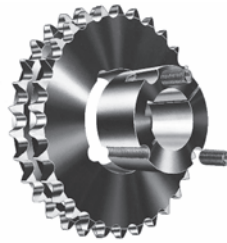

TAPER BUSHED  
DUPLEX



INSTANT  
SPLIT® SPROCKET

## Made-to-Order



TAPER BUSHED  
DOUBLE-SIMPLEX  
HARDENED TEETH  
**Double Simplex**



QD  
SIMPLEX  
**QD Sprockets**



IDLER  
BALL BEARING  
**Idler Sprockets**



TYPE B  
SIMPLEX  
STAINLESS  
**Stainless Steel**

# ISO 06B-1

## METRIC 35

# Metric Sprockets

### CHAIN DATA:

BS 228/3  
 ISO 06B-1  
 PITCH: 9.53 mm (0.375")  
 ROLLER DIAMETER: 6.35 mm (0.250")  
 ROLLER WIDTH: 5.72 mm (0.225")  
 TENSILE: 910 kilos (2000 lbs.)

## 0.375 INCH (9.525 mm) PITCH SIMPLEX

### Simplex - Type B — Steel

### Simplex - Type A — Steel

No. Teeth	Pitch Diameter MM	Catalog Number	Bore		Hub		Weight Approx. (kg)	Catalog Number	Bore Stock MM	Weight Approx. (kg)
			Stock MM	Max. MM	Dia. MM	Thru MM				
8	24.89	06B8	8	9	13	22	0.03	—	—	—
9	27.85	06B9	8	11	16	22	0.04	—	—	—
10	30.82	06B10	8	12	20	22	0.06	—	—	—
11	33.81	06B11	8	14	23	25	0.09	—	—	—
12	36.80	06B12	8	16	26	25	0.10	—	—	—
13	39.80	06B13	10	18	29	25	0.11	—	—	—
14	42.80	06B14	10	19	31	25	0.12	—	—	—
15	45.81	06B15	10	20	34	25	0.14	06A15	8	0.07
16	48.82	06B16	10	22	37	25	0.18	06A16	10	0.08
17	51.84	06B17	10	25	40	28	0.20	06A17	10	0.18
18	54.85	06B18	10	25	43	28	0.23	06A18	10	0.11
19	57.87	06B19	10	28	46	28	0.25	06A19	10	0.12
20	60.89	06B20	10	30	49	28	0.31	06A20	10	0.13
21	63.91	06B21	12	30	50	28	0.36	06A21	10	0.14
22	66.93	06B22	12	32	51	28	0.37	06A22	10	0.15
23	69.95	06B23	12	32	52	28	0.39	06A23	10	0.17
24	72.97	06B24	12	32	54	28	0.40	06A24	10	0.19
25	76.00	06B25	12	35	57	28	0.41	06A25	10	0.20
26	79.02	06B26	12	38	60	28	0.42	06A26	10	0.21
27	82.05	06B27	12	38	60	28	0.44	06A27	10	0.22
28	85.07	06B28	12	38	60	28	0.45	06A28	10	0.23
29	88.10	06B29	12	38	60	28	0.47	06A29	10	0.25
30	91.12	06B30	12	38	60	30	0.48	06A30	10	0.27
32	97.18	06B32	14	40	65	30	0.56	06A32	12	0.20
35	106.26	06B35	14	40	65	30	0.68	06A35	12	0.27
36	109.29	06B36	16	45	70	30	0.71	06A36	12	0.28
38	115.35	06B38	16	45	70	30	0.77	06A38	14	0.43
40	121.40	06B40	16	45	70	30	0.81	06A40	14	0.45
42	127.46	06B42	16	45	70	30	0.85	06A42	14	0.48
45	136.55	06B45	16	45	75	30	0.91	06A45	14	0.51
48	145.64	06B48	16	45	75	30	0.97	06A48	14	0.54
54	163.82	06B54	16	45	75	30	1.09	06A54	14	0.61
57	172.91	06B57	19	45	75	30	1.27	06A57	18	0.86
60	182.00	06B60	19	45	75	30	1.34	06A60	18	0.91
64	194.12	06B64	19	45	75	30	1.43	06A64	18	0.97
70	212.30	06B70	19	45	75	30	1.56	06A70	18	1.06
72	218.37	06B72	19	45	75	30	1.60	06A72	18	1.09
76	230.49	06B76	19	45	75	30	1.91	06A76	18	1.45
80	242.61	06B80	19	45	75	30	2.01	06A80	18	1.53
84	254.74	06B84	19	45	75	30	2.11	06A84	18	1.60
90	272.93	06B90	19	52	75	30	2.26	06A90	18	1.72
95	288.08	06B95	19	52	75	30	2.61	06A95	18	2.18
96	291.11	06B96	19	52	75	30	2.64	06A96	18	2.20
114	345.68	06B114	19	52	75	30	3.63	06A114	18	3.13

Maximum bores shown will accommodate standard keyseat and setscrew over keyseat. Slightly larger bores are possible with no keyseat, shallow keyseat, or setscrew at angle to keyseat.

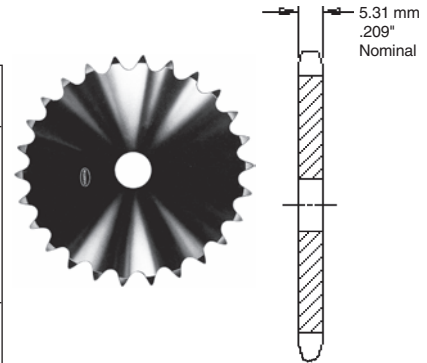

TYPE A

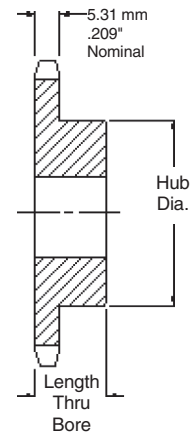

TYPE B

### 0.375 INCH (9.525 mm) PITCH **SIMPLEX**

**CHAIN DATA:**

BS 228/3  
 ISO 06B-1  
 PITCH: 9.53 mm (0.375")  
 ROLLER DIAMETER: 6.35 mm (0.250")  
 ROLLER WIDTH: 5.72 mm (0.225")  
 TENSILE: 910 kilos (2000 lbs.)

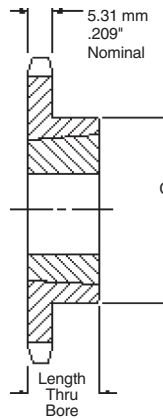
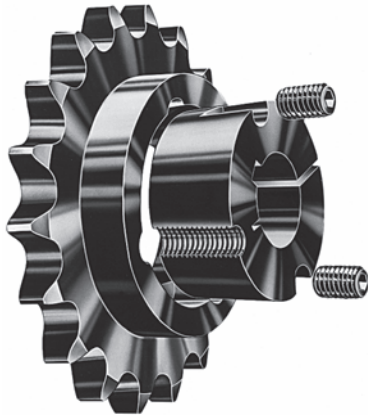

**TYPE B**

### Simplex- Taper Bushed — Steel

No. Teeth	Pitch Diameter MM	Catalog Number	Bushing Number	Bore Max. MM	Dimension		Weight Approx.	
					L MM	C MM	Rim (kg)	Bushing (kg)
18	54.85	06BTB18H	1008	25.40	22.23	47.63★	0.18	0.14
19	57.87	06BTB19H	1008	25.40	22.23	46.04	0.23	0.14
20	60.89	06BTB20H	1008	25.40	22.23	49.20	0.27	0.14
21	63.91	06BTB21H	1008	25.40	22.23	52.39	0.32	0.14
22	66.93	06BTB22H	1210	31.75	25.40	60.33	0.36	0.27
23	69.95	06BTB23H	1210	31.75	25.40	61.91	0.41	0.27
24	72.97	06BTB24H	1210	31.75	25.40	61.91	0.41	0.27
25	76.00	06BTB25H	1210	31.75	25.40	61.91	0.54	0.27
26	79.02	06BTB26H	1610	41.28	25.40	73.03*	0.50	0.41
28	85.07	06BTB28H	1610	41.28	25.40	73.03	0.54	0.41
30	91.12	06BTB30H	1610	41.28	25.40	79.38	0.54	0.41
32	97.18	06BTB32	1610	41.28	25.40	82.55	0.59	0.41
35	106.26	06BTB35	1610	41.28	25.40	82.55	0.64	0.41
36	109.29	06BTB36	1610	41.28	25.40	82.55	0.64	0.41
38	115.35	06BTB38	1610	41.28	25.40	82.55	0.68	0.41
40	121.40	06BTB40	1610	41.28	25.40	82.55	0.86	0.41
45	136.55	06BTB45	1610	41.28	25.40	82.55	0.95	0.41
48	145.65	06BTB48	1610	41.28	25.40	82.55	1.04	0.41
54	163.82	06BTB54	1610	41.28	25.40	82.55	1.18	0.41
57	172.91	06BTB57	1610	41.28	25.40	82.55	1.25	0.41
60	182.00	06BTB60	1610	41.28	25.40	82.55	1.36	0.41
70	212.30	06BTB70	1610	41.28	25.40	82.55	1.68	0.41
76	230.49	06BTB76	1610	41.28	25.40	82.55	1.82	0.41
95	288.08	06BTB95	1610	41.28	25.40	82.55	2.28	0.41

★ Has recessed groove in hub for chain clearance.  
 Sprockets with "H" suffix have hardened teeth.

# ISO 06B-2

## METRIC 35-2

# Metric Sprockets

### CHAIN DATA:

BS 228/3  
 ISO 06B-2  
 PITCH: 9.53 mm (0.375")  
 ROLLER DIAMETER: 6.35 mm (0.250")  
 ROLLER WIDTH: 5.72 mm (0.225")  
 TENSILE: 1730 kilos (3800 lbs.)

## 0.375 INCH (9.525 mm) PITCH DUPLEX WIDTH CHAIN

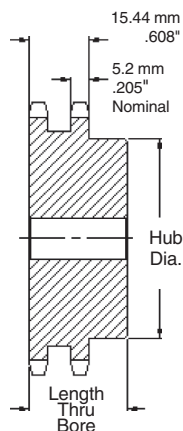

TYPE B

### Duplex - Type B — Steel

No. Teeth	Pitch Diameter MM	Catalog Number	Bore		Hub		Weight Approx. (kg)
			Stock MM	Max. MM	Dia. MM	Thru MM	
12	36.80	D06B12	10	16	25	25	0.16
13	39.79	D06B13	10	18	28	25	0.20
14	42.80	D06B14	10	18	31	25	0.25
15	45.81	D06B15	10	20	34	25	0.29
16	48.82	D06B16	12	20	37	30	0.34
17	51.83	D06B17	12	24	40	30	0.39
18	54.85	D06B18	12	25	43	30	0.45
19	57.87	D06B19	12	28	46	30	0.52
20	60.89	D06B20	12	30	49	30	0.59
21	63.91	D06B21	12	30	52	30	0.68
22	66.93	D06B22	12	35	55	30	0.75
23	69.95	D06B23	12	38	58	30	0.80
24	72.97	D06B24	12	39	61	30	0.84
25	76.00	D06B25	12	40	64	30	0.89
26	79.02	D06B26	12	42	67	30	0.91
27	82.05	D06B27	12	45	70	30	1.00
28	85.07	D06B28	12	48	73	30	1.07
29	88.10	D06B29	12	50	76	30	1.14
30	91.12	D06B30	12	52	80	30	1.22
32	98.18	D06B32	16	52	80	30	1.30
35	106.26	D06B35	16	52	80	30	1.42
36	109.29	D06B36	16	60	90	30	1.58
38	115.35	D06B38	16	60	90	30	1.72
40	121.40	D06B40	16	52	80	35	1.81
42	127.46	D06B42	19	60	90	35	2.05
45	136.55	D06B45	19	60	90	35	2.35
48	145.64	D06B48	19	60	90	35	2.75
52	157.75	D06B52	19	60	90	35	3.13
57	172.91	D06B57	19	60	90	35	3.47
60	182.00	D06B60	19	60	90	35	3.78
68	206.24	D06B68	19	60	90	35	4.43
70	212.30	D06B70	19	60	90	35	4.56
72	218.37	D06B72	19	60	90	35	4.89
76	230.49	D06B76	19	60	90	38	5.67
84	254.74	D06B84	19	60	90	38	7.10
95	288.08	D06B95	25	62	95	38	8.64
96	291.11	D06B96	25	62	95	38	8.75
114	345.68	D06B114	25	62	95	38	11.12

Maximum bores shown will accommodate standard keyseat and setscrew over keyseat. Slightly larger bores are possible with no keyseat, shallow keyseat, or setscrew at angle to keyseat.

### 0.375 INCH (9.525 mm) PITCH DUPLEX WIDTH CHAINS

#### CHAIN DATA:

BS 228/3  
 ISO 06B-2  
 PITCH: 9.53 mm (0.375")  
 ROLLER DIAMETER: 6.35 mm (0.250")  
 ROLLER WIDTH: 5.72 mm (0.225")  
 TENSILE: 1730 kilos (3800 lbs.)

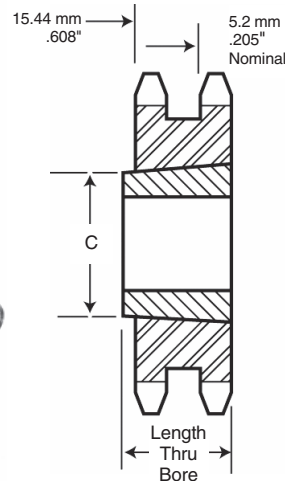
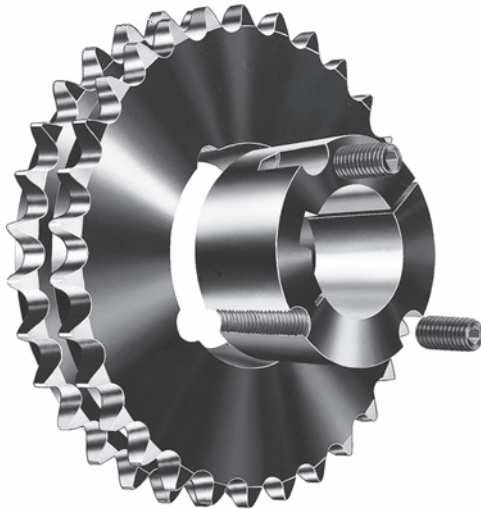

**TYPE B**

### Duplex - Taper Bushed — Steel

No. Teeth	Pitch Diameter MM	Catalog Number	Bushing Number	Bore Max. MM	Dimension		Weight Approx.	
					L MM	C MM	Rim (kg)	Bushing (kg)
19	57.87	D06BTB19	1008	25.40	22.23	46.43	0.6	0.14
20	60.89	D06BTB20	1008	25.40	22.23	49.20	0.8	0.14
21	63.91	D06BTB21	1008	25.40	22.23	52.39	1.4	0.14
22	66.93	D06BTB22	1008	25.40	22.23	55.56	1.7	0.14
24	72.97	D06BTB24	1210	31.75	25.40	61.91	1.8	0.27
25	76.00	D06BTB25	1210	31.75	25.40	61.91	1.9	0.27
26	79.02	D06BTB26	1210	31.75	25.40	66.68	2.0	0.27
30	91.12	D06BTB30	1610	41.28	25.40	79.38	1.8	0.41
32	97.18	D06BTB32	1610	41.28	25.40	82.55	2.0	0.41
35	106.26	D06BTB35	1610	41.28	25.40	82.55	2.3	0.41
38	115.34	D06BTB38	1610	41.28	25.40	82.55	2.5	0.41
40	121.40	D06BTB40	1610	41.28	25.40	82.55	2.9	0.41
45	136.55	D06BTB45	1610	41.28	25.40	82.55	3.2	0.41
48	145.65	D06BTB48	1610	41.28	25.40	92.08	3.5	0.41
54	163.82	D06BTB54	1610	41.28	25.40	92.08	3.9	0.41
57	172.91	D06BTB57	1610	41.28	25.40	92.08	4.1	0.41
60	182.00	D06BTB60	1610	41.28	25.40	92.08	4.9	0.41
70	212.30	D06BTB70	1610	41.28	25.40	92.08	6.3	0.41
76	230.49	D06BTB76	1610	41.28	25.40	92.08	6.8	0.41
95	288.08	D06BTB95	1610	41.28	25.40	92.08	6.9	0.41

# ISO 06B-3

## METRIC 35-3

# Metric Sprockets

### CHAIN DATA:

BS 228/3  
 ISO 06B-3  
 PITCH: 9.53 mm (0.375")  
 ROLLER DIAMETER: 6.35 mm (0.250")  
 ROLLER WIDTH: 5.72 mm (0.225")  
 TENSILE: 2540 kilos (5600 lbs.)

## 0.375 INCH (9.525 mm) PITCH TRIPLEX

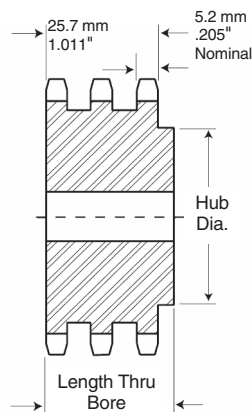

**TYPE B**

### Triplex - Type B — Steel

No. Teeth	Pitch Diameter MM	Catalog Number	Bore		Hub		Weight Approx. (kg)
			Stock MM	Max. MM	Dia. MM	Thru MM	
12	36.80	E06B12	12	16	25	35	0.23
13	39.80	E06B13	12	18	28	35	0.27
14	42.80	E06B14	12	18	31	35	0.32
15	45.81	E06B15	12	20	34	35	0.36
16	48.82	E06B16	12	20	37	35	0.45
17	51.84	E06B17	12	24	40	35	0.54
18	54.85	E06B18	12	25	43	35	0.64
19	57.87	E06B19	12	28	46	35	0.72
20	60.89	E06B20	12	30	49	35	0.77
21	63.91	E06B21	14	30	52	40	0.86
22	66.93	E06B22	14	35	54	40	0.95
23	69.95	E06B23	14	38	58	40	1.04
24	72.97	E06B24	14	39	61	40	1.18
25	76.00	E06B25	14	40	64	40	1.27
26	79.02	E06B26	14	42	67	40	1.31
27	82.05	E06B27	14	45	70	40	1.36
28	85.07	E06B28	14	48	73	40	1.50
29	88.10	E06B29	14	50	76	40	1.68
30	91.12	E06B30	14	52	80	40	1.72
32	97.18	E06B32	16	52	80	48	2.00
35	106.26	E06B35	16	52	80	48	2.25
36	109.29	E06B36	16	60	90	40	2.33
38	115.34	E06B38	16	60	90	40	2.49
40	121.40	E06B40	16	52	80	48	2.65
42	127.46	E06B42	19	60	90	48	2.81
45	136.55	E06B45	19	60	90	48	3.00
48	145.64	E06B48	19	60	90	48	3.20
52	157.75	E06B52	19	60	90	48	3.46
57	172.91	E06B57	19	60	90	48	4.77
60	182.00	E06B60	19	60	80	48	5.02
68	206.24	E06B68	19	60	90	48	5.69
72	218.37	E06B72	19	60	90	48	6.02
76	230.49	E06B76	19	64	100	48	8.48
84	254.74	E06B84	19	64	100	48	9.37
95	288.08	E06B95	25	64	100	54	13.61
96	291.11	E06B96	25	64	100	54	13.75
114	345.68	E06B114	25	64	100	54	17.48

# Martin

## Metric Sprockets

# ISO 08B-1

## METRIC 40

### 0.500 INCH (12.70 mm) PITCH **SIMPLEX**

**CHAIN DATA:**

BS 228/7

ISO 08B-1

PITCH: 12.70 mm (0.500")

ROLLER DIAMETER: 8.51 mm (0.335")

ROLLER WIDTH: 7.75 mm (0.305")

TENSILE: 1820 kilos (4000 lbs.)

### Simplex - Type A — Steel

### Simplex - Type B — Steel

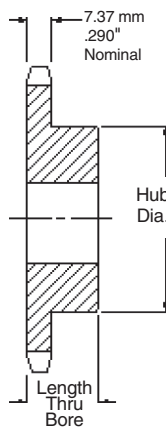
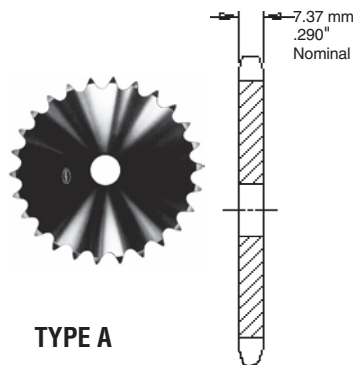

**TYPE B**

No. Teeth	Pitch Diameter MM	Catalog Number	Bore		Hub		Weight Approx. (kg)	Catalog Number	Bore Stock MM	Weight Approx. (kg)
			Stock MM	Max. MM	Dia. MM	Thru MM				
9	37.13	08B9	10	15	21	25	0.14	—	—	—
10	41.10	08B10	10	20	26	25	0.15	—	—	—
11	45.08	08B11	10	22	30	25	0.17	—	—	—
12	49.07	08B12	10	22	34	28	0.24	08A12	10	0.08
13	53.07	08B13	10	25	38	28	0.25	08A13	10	0.10
14	57.07	08B14	10	28	42	28	0.31	08A14	10	0.12
15	61.08	08B15	10	30	46	28	0.33	08A15	10	0.14
16	65.10	08B16	12	32	50	28	0.37	08A16	10	0.15
17	69.12	08B17	12	35	54	28	0.51	08A17	10	0.16
18	73.14	08B18	12	38	57	28	0.54	08A18	10	0.20
19	77.16	08B19	12	40	64	28	0.65	08A19	10	0.21
20	81.18	08B20	12	42	67	28	0.76	08A20	10	0.25
21	85.21	08B21	12	45	70	28	0.82	08A21	12	0.26
22	89.24	08B22	12	48	73	28	0.88	08A22	12	0.30
23	93.27	08B23	12	51	78	28	1.05	08A23	12	0.33
24	97.30	08B24	14	53	82	28	1.05	08A24	12	0.37
25	101.33	08B25	14	53	82	28	1.13	08A25	12	0.40
26	105.36	08B26	16	53	82	30	1.15	08A26	16	0.43
27	109.40	08B27	16	53	82	30	1.19	08A27	16	0.44
28	113.43	08B28	16	53	82	30	1.30	08A28	16	0.50
29	117.46	08B29	16	53	82	30	1.33	08A29	16	0.55
30	121.50	08B30	16	53	89	30	1.36	08A30	15	0.57
31	125.53	08B31	16	60	89	30	1.41	08A31	15	0.64
32	129.57	08B32	16	60	89	30	1.46	08A32	15	0.67
33	133.61	08B33	16	60	89	30	1.51	08A33	15	0.71
34	137.64	08B34	16	60	89	30	1.56	08A34	15	0.74
35	141.68	08B35	16	60	89	30	1.61	08A35	15	0.77
36	145.72	08B36	16	60	89	35	1.69	08A36	15	0.83
37	149.75	08B37	16	60	89	35	1.74	08A37	15	0.87
38	153.79	08B38	16	60	89	35	1.78	08A38	15	0.91
39	157.83	08B39	19	60	89	35	1.83	08A39	18	0.92
40	161.87	08B40	19	60	89	35	1.88	08A40	18	1.01
42	169.94	08B42	19	60	89	35	1.97	08A42	18	1.13
45	182.06	08B45	19	60	89	35	2.11	08A45	18	1.43
48	194.18	08B48	19	64	100	35	2.76	08A48	18	1.46
54	218.42	08B54	19	64	100	35	3.11	08A54	18	2.01
57	230.54	08B57	19	64	100	35	3.28	08A57	18	2.27
60	242.66	08B60	19	64	100	35	3.45	08A60	18	2.03
64	258.83	08B64	19	64	100	35	3.68	08A64	18	2.17
70	283.07	08B70	19	64	100	35	4.02	08A70	18	3.28
72	291.15	08B72	19	64	100	35	4.13	08A72	18	3.51
76	307.32	08B76	19	64	100	35	5.73	08A76	18	3.70
80	323.49	08B80	19	64	100	35	6.03	08A80	18	4.63
84	339.65	08B84	19	64	100	35	6.33	08A84	18	4.57
95	384.11	08B95	25	64	100	35	8.90	08A95	24	5.45
96	388.15	08B96	25	64	100	35	8.99	08A96	24	5.51
114	460.91	08B114	25	64	100	35	11.17	08A114	24	6.54

Maximum bores shown will accommodate standard keyseat and setscrew over keyseat. Slightly larger bores are possible with no keyseat, shallow keyseat, or setscrew at angle to keyseat.

# ISO 08B-1

## METRIC 40

# Metric Sprockets

### CHAIN DATA:

BS 228/7  
 ISO 08B-1  
 PITCH: 12.70 mm (0.500")  
 ROLLER DIAMETER: 8.51 mm (0.335")  
 ROLLER WIDTH: 7.75 mm (0.305")  
 TENSILE: 1820 kilos (4000 lbs.)

## 0.500 INCH (12.70 mm) PITCH SIMPLEX

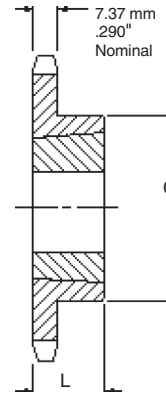
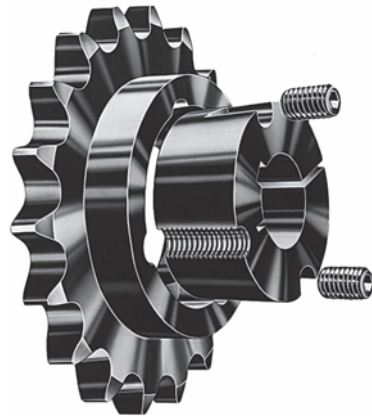

TYPE B

### Simplex - Taper Bushed — Steel

No. Teeth	Pitch Diameter MM	Catalog Number	Bushing Number	Bore Max. MM	Dimension		Weight Approx.	
					L MM	C MM	Rim (kg)	Bushing (kg)
14	57.07	08BTB14H	1008	25.40	22.23	46★	0.18	0.14
15	61.08	08BTB15H	1008	25.40	22.23	46	0.18	0.14
16	65.10	08BTB16H	1008	25.40	22.23	46	0.23	0.14
17	69.12	08BTB17H	1210	31.75	25.40	60★	0.23	0.14
18	73.14	08BTB18H	1210	31.75	25.40	62★	0.27	0.27
19	77.16	08BTB19H	1210	31.75	25.40	62	0.32	0.27
20	81.18	08BTB20H	1610	41.28	25.40	70★	0.41	0.41
21	85.21	08BTB21H	1610	41.28	25.40	70	0.45	0.41
22	89.24	08BTB22H	1610	41.28	25.40	70	0.50	0.41
23	93.27	08BTB23H	1610	41.28	25.40	76	0.59	0.41
24	97.30	08BTB24H	1610	41.28	25.40	82	0.73	0.41
25	101.33	08BTB25H	1610	41.28	25.40	82	0.73	0.41
26	105.36	08BTB26H	1610	41.28	25.40	82	0.73	0.41
27	109.40	08BTB27H	1610	41.28	25.40	76	0.70	0.41
28	113.43	08BTB28H	1610	41.28	25.40	76	0.73	0.41
29	117.46	08BTB29H	1610	41.28	25.40	76	0.76	0.41
30	121.50	08BTB30H	1610	41.28	25.40	73	0.82	0.41
32	129.57	08BTB32	1610	41.28	25.40	76	0.87	0.41
35	141.68	08BTB35	1610	41.28	25.40	76	0.96	0.41
36	145.72	08BTB36	1610	41.28	25.40	76	0.98	0.41
38	153.79	08BTB38	1610	41.28	25.40	76	1.23	0.41
40	161.87	08BTB40	1610	41.28	25.40	76	1.29	0.41
42	169.94	08BTB42	1610	41.28	25.40	76	1.36	0.41
45	182.06	08BTB45	1610	41.28	25.40	76	1.46	0.41
48	194.18	08BTB48	1610	41.28	25.40	76	1.55	0.41
54	218.42	08BTB54	1610	41.28	25.40	76	1.75	0.41
57	230.54	08BTB57	1610	41.28	25.40	76	2.63	0.41
60	242.66	08BTB60	1610	41.28	25.40	76	2.77	0.41
70	283.07	08BTB70	2012	50.80	31.75	90	3.93	0.41
72	291.15	08BTB72	2012	50.80	31.75	90	4.05	0.41
76	307.32	08BTB76	2012	50.80	31.75	90	4.27	0.77
80	323.49	08BTB80	2012	50.80	31.75	90	4.49	0.77
84	339.65	08BTB84	2012	50.80	31.75	90	4.72	0.77
95	384.11	08BTB95	2012	50.80	31.75	90	6.81	0.77
96	388.15	08BTB96	2012	50.80	31.75	90	6.88	0.77
114	460.91	08BTB114	2517	63.50	44.45	108	10.44	0.77

★ Has recessed groove in hub for chain clearance.  
 Sprockets with "H" suffix have hardened teeth.



### 0.500 INCH (12.70 mm) PITCH DUPLEX

**CHAIN DATA:**  
 BS 228/7  
 ISO 08B-2  
 PITCH: 12.70 mm (0.500")  
 ROLLER DIAMETER: 8.51 mm (0.335")  
 ROLLER WIDTH: 7.75 mm (0.305")  
 TENSILE: 3180 kilos (7000 lbs.)

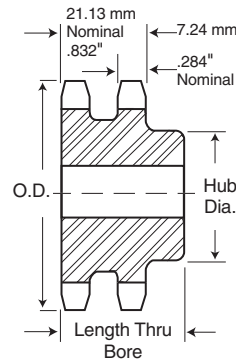

### Duplex - Type B — Steel

No. Teeth	Pitch Diameter	Catalog Number	Bore		Hub		Weight Approx. (kg)
	MM		Stock MM	Max. MM	Dia. MM	Thru MM	
10	41.10	D08B10	10	18	26	32	0.22
11	45.08	D08B11	11	21	30	35	0.22
12	49.07	D08B12	12	23	34	35	0.26
13	53.07	D08B13	12	25	38	35	0.28
14	57.07	D08B14	12	28	42	35	0.34
15	61.08	D08B15	12	30	46	35	0.36
16	65.10	D08B16	14	33	50	35	0.35
17	69.12	D08B17	14	36	54	35	0.44
18	73.14	D08B18	14	38	58	35	0.49
19	77.16	D08B19	14	40	62	35	0.57
20	81.18	D08B20	14	40	66	35	0.65
21	85.21	D08B21	16	45	70	40	0.72
22	89.24	D08B22	16	45	70	40	0.73
23	93.27	D08B23	16	45	70	40	0.83
24	97.30	D08B24	16	50	75	40	0.94
25	101.33	D08B25	16	52	80	40	0.98
26	105.36	D08B26	20	56	85	40	1.04
27	109.40	D08B27	20	56	85	40	1.08
28	113.43	D08B28	20	60	90	40	1.10
29	117.46	D08B29	20	62	95	40	1.14
30	121.50	D08B30	20	64	100	40	1.16
32	129.57	D08B32	20	64	100	40	1.24
35	141.68	D08B35	20	64	100	40	1.35
36	145.72	D08B36	20	73	110	40	2.05
38	153.79	D08B38	20	73	110	45	2.17
40	161.87	D08B40	20	73	110	45	2.28
42	169.94	D08B42	20	73	110	45	2.32
45	182.06	D08B45	20	73	110	45	2.49
48	194.18	D08B48	20	73	110	45	2.65
54	218.42	D08B54	25	73	110	45	2.98
57	230.54	D08B57	25	73	110	45	3.88
60	242.66	D08B60	25	73	110	45	4.08
68	283.07	D08B68	25	73	110	45	4.63
72	291.16	D08B72	25	73	110	45	4.90
76	307.32	D08B76	30	80	120	45	6.60
84	339.65	D08B84	30	80	120	45	7.29
95	384.11	D08B95	30	80	120	45	9.89
96	388.15	D08B96	30	80	120	45	9.99
114	460.90	D08B114	30	80	120	45	12.88

Maximum bores shown will accommodate standard keyseat and setscrew over keyseat. Slightly larger bores are possible with no keyseat, shallow keyseat, or setscrew at angle to keyseat.

# ISO 08B-2

## METRIC 40-2

# Metric Sprockets

**CHAIN DATA:**  
 BS 228/7  
 ISO 08B-2  
 PITCH: 12.70 mm (0.500")  
 ROLLER DIAMETER: 8.51 mm  
 (0.335")  
 ROLLER WIDTH: 7.75 mm  
 (0.305")  
 TENSILE: 3180 kilos (7000 lbs.)

## 0.500 INCH (12.70 mm) PITCH DUPLEX

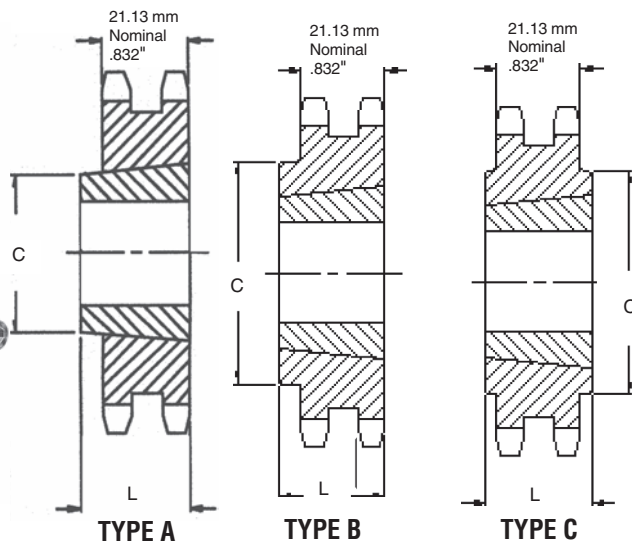
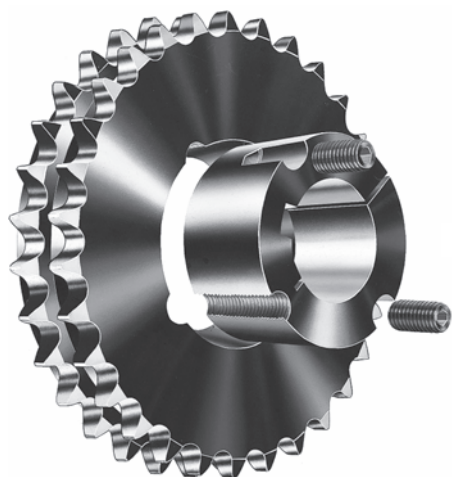

### Duplex - Taper Bushed — Steel

No. Teeth	Pitch Diameter MM	Catalog Number	Bushing Number	Bore Max. MM	Dimension		Weight	
					L MM	C MM	Rim (kg)	Bushing (kg)
15	61.08	D08ATB15	1008	25.40	22.22	—	0.18	0.13
16	65.10	D08ATB16	1008	25.40	22.22	—	0.22	0.13
17	69.12	D08ATB17	1008	25.40	22.22	—	0.27	0.13
18	73.14	D08BTB18	1210	31.75	25.40	58	0.27	0.27
19	77.16	D08BTB19	1210	31.75	25.40	63	0.36	0.27
20	81.18	D08BTB20	1610	41.27	25.40	70	0.37	0.41
21	85.21	D08BTB21	1610	41.27	25.40	70	0.46	0.41
22	89.24	D08BTB22	1610	41.27	25.40	74	0.55	0.41
23	93.27	D08BTB23	1610	41.27	25.40	78	0.59	0.41
24	97.30	D08BTB24	2012	41.27	25.40	83	0.70	0.41
25	101.33	D08BTB25	2012	50.80	31.75	87	0.77	0.77
26	105.36	D08BTB26	2012	50.80	31.75	87	0.80	0.77
28	113.43	D08BTB28	2012	50.80	31.75	99	1.06	0.77
30	121.50	D08BTB30	2012	50.80	31.75	108	1.59	0.77
35	141.68	D08BTB35	2012	50.80	31.75	108	1.86	0.77
36	145.72	D08BTB36	2012	50.80	31.75	108	1.91	0.77
38	153.79	D08BTB38	2012	50.80	31.75	108	3.18	0.77
42	169.94	D08CTB42	2517	50.80	44.45	108	5.57	1.59
45	182.06	D08CTB45	2517	63.50	44.45	108	5.97	1.59
48	194.18	D08CTB48	2517	63.50	44.45	108	6.37	1.59
54	218.42	D08CTB54	2517	63.50	44.45	108	7.17	1.59
57	230.54	D08CTB57	2517	63.50	44.45	108	7.56	1.59
60	242.66	D08CTB60	2517	63.50	44.45	108	12.05	1.59
68	274.99	D08CTB68	2517	63.50	44.45	108	13.66	1.59
70	283.07	D08CTB70	2517	63.50	44.45	108	14.06	1.59
72	291.15	D08CTB72	2517	63.50	44.45	108	14.46	1.59
76	307.32	D08CTB76	2517	63.50	44.45	108	15.26	1.59
84	339.65	D08CTB84	2517	63.50	44.45	108	16.87	1.59
95	384.11	D08CTB95	2517	63.50	44.45	108	19.08	1.59
96	388.15	D08CTB96	2517	63.50	44.45	108	19.28	1.59
114	460.91	D08CTB114	2517	63.50	44.45	108	22.90	1.59