

Rotary Seal Design Guide



Catalog EPS 5350/USA



ROTARY SEALS

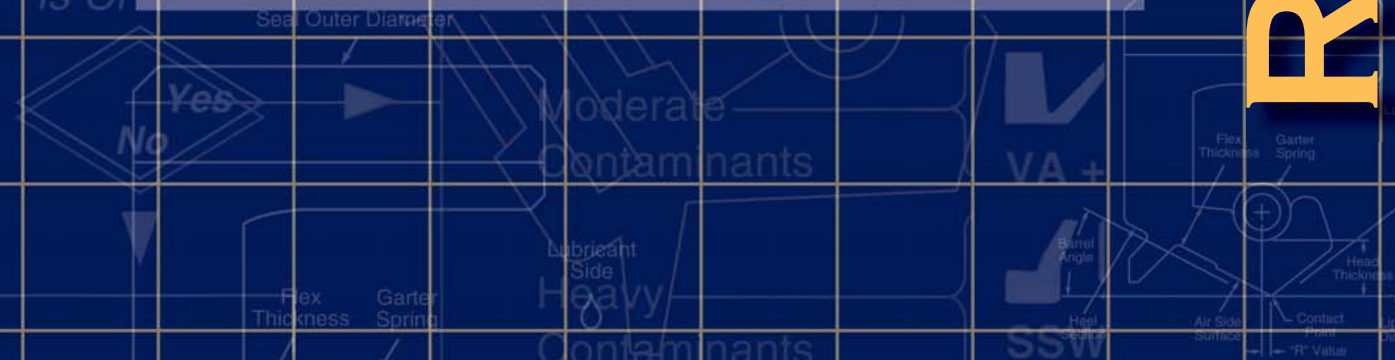



WARNING:

Failure, improper selection or improper use of the products and/or systems described herein or related items can cause death, personal injury or property damage.

For safe and trouble-free use of these products, it is important that you read and follow the Parker Seal Group Product Safety Guide. This Safety Guide can be referenced and downloaded free of charge at www.parkerseals.com and can be ordered, without charge, as Parker Publication No. PSG 5004 by calling 1-800-C-PARKER.

This document, along with other information from Parker Hannifin Corporation, its subsidiaries and authorized distributors, provides product and/or system options for further investigation by users having technical expertise. It is important that you analyze all aspects of your application and review the information concerning the products or systems in the current product catalog. Due to the variety of operating conditions and applications for these products or systems, the user, through his or her own analysis and testing, is solely responsible for making the final selection of the products and systems and assuring that all performance, safety and warning requirements of the application are met. The products described herein, including without limitation, product features, specifications, designs, availability and pricing, are subject to change by Parker Hannifin Corporation and its subsidiaries at any time without notice.

OFFER OF SALE

The items described in this document are hereby offered for sale by Parker Hannifin Corporation, its subsidiaries and its authorized distributors. This offer and its acceptance are governed by the provisions stated on the separate page of this document entitled "Offer of Sale."

©2006 Parker Hannifin Corporation

Rotary Seal Design Guide Table of Contents

Introduction

1

Engineering

2

Materials

3

Product Offering

4

Clipper[®] Oil Seals

5

Parker Oil Seals

6

Shaft Sleeves

7

See Appendices A through J for:

- Design Action Request Form
- Rotary Lip Seal Inch Size
- Rotary Lip Seal Metric Sizes
- Solid to Split Seal Calculator Inch & Metric
- Sleeve & V-Seal Sizes
- ProTech[™] Sizes Inch & Metric
- Conversions — Size/Speed/Temp.
- Chemical Compatibility
- Interchange
- Other Parker EPS Products

ProTech[™] Bearing Isolators

8

FlexiLip[™]

9

FlexiCase[™]

10

FlexiSeal[®] Rotary

11

V-Seals and Excluders

12



Parker Hannifin Corporation
EPS Division
Toll Free: (800) 233-3900

www.parkerseals.com

Rotary Seal Design Guide Appendix

A **Design Action Request Form**

B **Rotary Lip Seal Inch Sizes**

C **Rotary Lip Seal Metric Sizes**

D **Solid to Split Seal Calculator Inch & Metric**

E **Sleeve & V-Seal Sizes**

F **ProTech™ Sizes Inch & Metric**

G **Conversions — Size/Speed/Temp.**

H **Chemical Compatibility**

I **Interchange**

J **Other Parker EPS Products**



Parker Hannifin Corporation
EPS Division
Toll Free: (800) 233-3900

www.parkerseals.com

Introduction

Catalog EPS 5350/USA

The completeness of Parker's product line allows us to provide the optimal design for any rotating application.

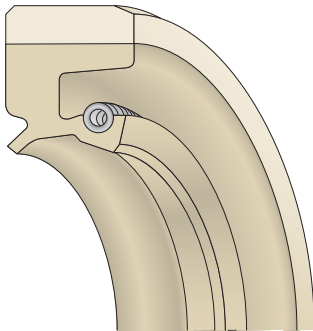

Parker's Rotary Sealing Solutions Program provides the most complete coverage in the industry of shaft seals for rotating applications, for both OEM and MRO requirements. The completeness of the product line allows Parker to provide the optimal design for any given application. Parker is more than just product. A complete solutions package has been created by supplementing the broadest range of products with full engineering support, strict quality standards, direct factory field support, R&D and premier customer service. At Parker EPS, seals are not an add-on to our business, seals are our only business.

Clipper® Oil Seal

The **Clipper Oil Seal** is the anchor of the rotary seal product line. The Clipper design features an integrally molded rubber fiber outer case and an elastomeric seal lip. The unique, nonmetallic construction will not rust or corrode and forms a gasket-type seal between the equipment housing and the seal outside diameter (OD). With a wide range of profiles and material options, Clipper seals are available for shaft diameters from 0.250" (6.35 mm) to over 65" (1651 mm).

Clipper Split Seals are known worldwide for being the easiest split seal to install because they do not require a coverplate to keep them in the housing. The robust, composite OD provides the best retention of any split seal on the market. Replacing failed seals in the field with Clipper Split Seals saves on downtime and lost production expenses. To make replacement even easier, specify Clipper solid seals as the OEM solid seal. When cutting a metallic seal is required for in-field replacement, there is the possibility of metal shavings entering the bearing. The non-metallic design of the Clipper seal eliminates this possibility.

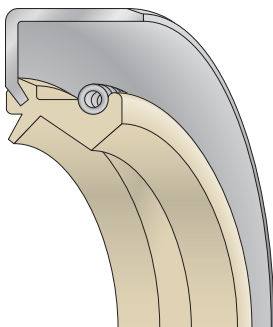

Parker Oil Seal

Parker Oil Seals provide additional coverage and include the common metal OD construction for inch requirements and rubber covered OD construction for metric requirements. Single lip and double lip profiles are available as well as over 100 special profiles for applications with unique operating conditions. The typical size range is for shaft diameters from 0.200" (5 mm) to 10" (254 mm).

03/28/06

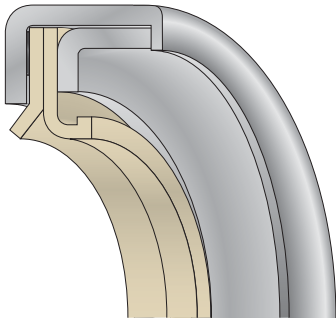

FlexiLip™, FlexiCase™ and FlexiSeal®

FlexiLip, FlexiCase and FlexiSeal PTFE seals extend the Parker application range by providing coverage where operating conditions exceed the capabilities of elastomeric lip materials. Conditions such as high speed and high pressure, and requirements for chemical resistance and low torque are easily accommodated by one of our 50 standard profiles. The typical size range is for shaft diameters from 0.125" (3 mm) to 16" (406 mm).

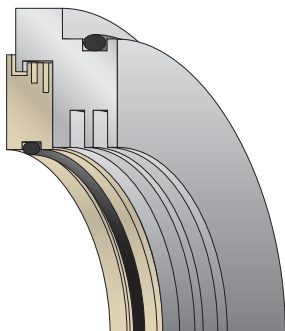

ProTech™ Bearing Isolators

ProTech bearing isolators further complement Parker's solutions program by offering an answer for applications where improving the mean time between failure (MTBF) is critical. The ProTech family relies on true non-contact labyrinth seal technology to provide 100% exclusion of contaminants and 100% retention of bearing lubrication for the life of the bearing. Fourteen standard profiles are available to allow for ease of retrofitting most equipment. Typical size range is for shaft diameters from 0.492" (12.5 mm) to 38" (965 mm). ProTech has also been independently tested to IEEE IP55, IP56, IP66 and IP69k.

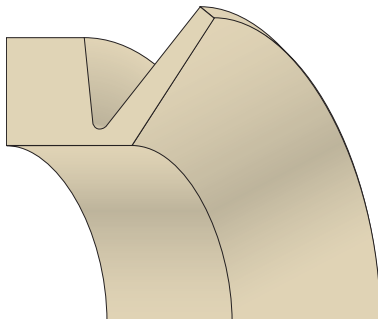

Quick Sleeve™, Wear Sleeve and V-Seals

Quick Sleeves, Wear Sleeves and V-Seals are auxiliary components that provide additional convenience to the Parker Sealing Solutions Program. Quick Sleeve shaft repair sleeves and Wear Sleeves are economical, convenient solutions to create proper shaft surfaces. V-Seals can be added as a slinger type seal to protect the primary seal or used as a primary seal to exclude dirt in grease applications.

03/28/06

Seal Decision Tree

Oil Retention, Shaft Speed under 3,000 fpm (15 m/s)

Note: Intended for use as a general design guide only.

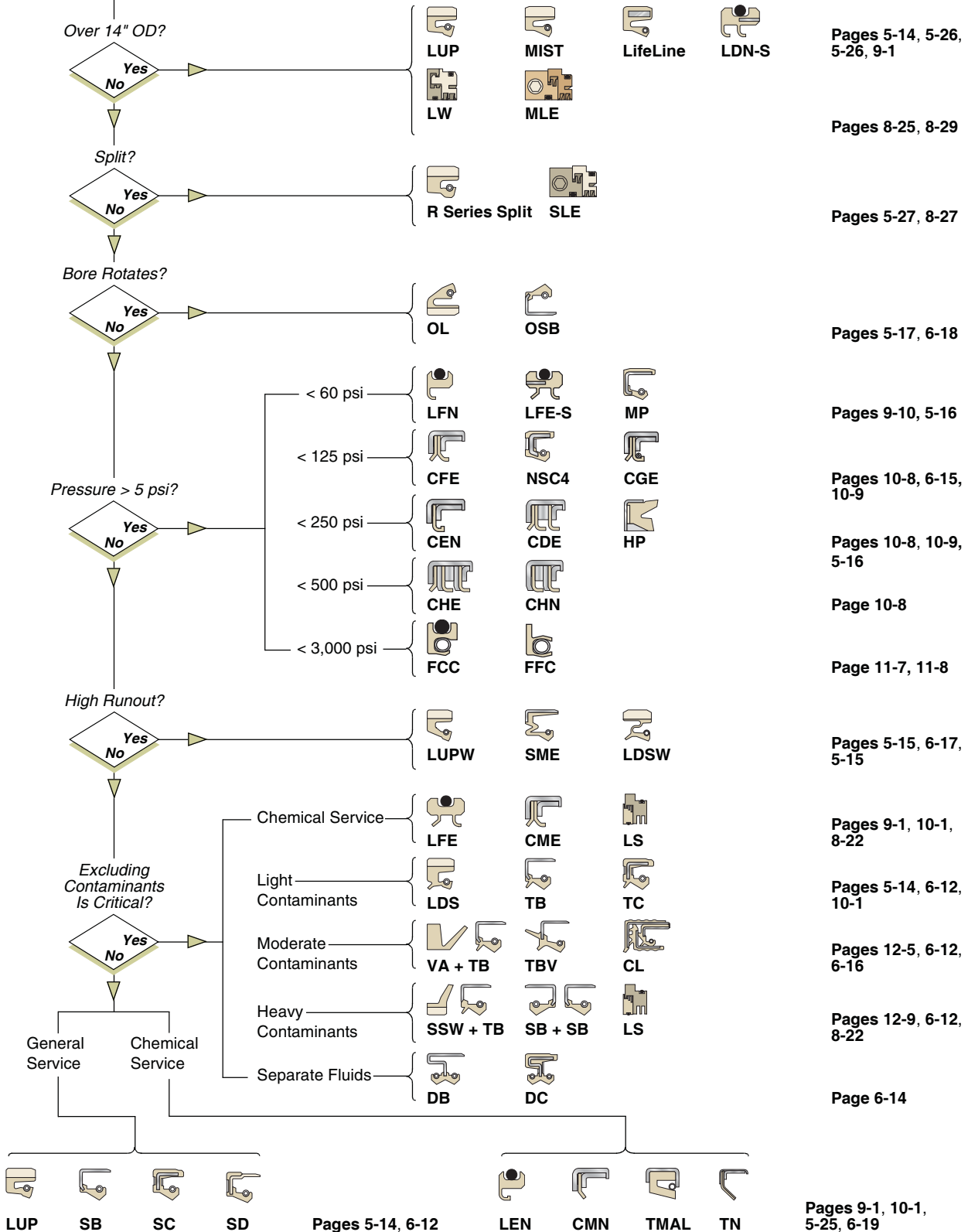

































































03/28/06



Clipper Oil Seal and Parker Oil Seal Profiles							
 Style A	 Style E	 Style L	 Style S	 BDC	 BDV	 BSC	 BSV
 CAP	 CB	 CH	 CL	 Clipper Sliptite	 DA	 DB	 DC
 DC4	 DL	 DS	 DM	 H	 HP	 KA	 KAP
 KB	 KBJ	 KBP	 KC	 KC8	 KCJ	 KG	 KM
 LDS	 LDSF	 LDSW	 LifeLine	 LPD	 LPD Spring Retainer	 LPDW	 LUP
 LUPW	 MP	 MIST	 NSC1	 NSC3	 NSC4	 NTC1	 NTC3
 NTC4	 OKA	 OKB	 OKC	 OKM	 OL	 OSA	 OSB
 OSC	 OSM	 OTA	 OTB	 OTM	 OTC	 OUA	 OUB
 OUC	 OUM	 OVA	 OVB	 OVC	 OVM	 P	 RPD
 RPDT	 RUP	 RUPW	 SA	 SAE	 SAP	 SB	 SBF
 SBJ	 SBP	 SC	 SCE	 SCF	 SCJ	 SD	 SD2
 SEC	 SEM	 SDS	 SG	 SM	 SME	 SS	 SSW

03/28/06











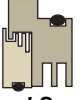



Clipper Oil Seal and Parker Oil Seal Profiles (Continued)

 STLUP	 STLUP w/Buttons	 ST MIST	 ST MIST w/Buttons	 SXA	 SXB	 SXC	 TA
 TAP	 TB	 TBF	 TBH2	 TBH4	 TBJ	 TBP	 TBV
 TBY2	 TBY3	 TC	 TC8	 TC12	 TCF	 TCJ	 TCV
 TCK	 TC9	 TD	 TD6	 TDN3	 TEA	 TEC	 TEM
 TG	 TG13	 TM	 TMAL	 TMAS	 TN	 TSS	 UA
 UB	 UC	 VA	 VAP	 VB	 VB1	 VB3	 VB4
 VB6	 VBJ	 VBP	 VC	 VCJ	 VG	 VM	 VM1
 VM2	 W	 WPC	 WPK	 WPR	 **L	 **R	 **W

Shaft Seal Profiles

 Quick Sleeve	 Wear Sleeve — Flanged	 Wear Sleeve — Non-flanged
--	---	---













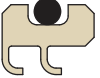







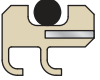



















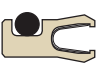

ProTech Bearing Isolator Profiles

 LS	 LN	 WD	 FS	 FN	 SB	 LB
 LM	 LD	 LW/LX	 SL	 ML	 MN	 SM

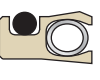
**Hydrodynamic lip pattern.
L = CCW shaft rotation
R = CW shaft rotation
W = Bi-directional shaft rotation

03/28/06



FlexiLip, FlexiCase and FlexiSeal Rotary Profiles							
 <i>LFN-N</i>	 <i>LEN-N</i>	 <i>LDN-N</i>	 <i>LMN-N</i>	 <i>LFE-N</i>	 <i>LEE-N</i>	 <i>LDE-N</i>	 <i>LGN-N</i>
 <i>LFN-S</i>	 <i>LEN-S</i>	 <i>LDN-S</i>	 <i>LMN-S</i>	 <i>LFE-S</i>	 <i>LEE-S</i>	 <i>LDE-S</i>	 <i>LGN-S</i>
 <i>CFN</i>	 <i>CFE</i>	 <i>CMN</i>	 <i>CME</i>	 <i>CEN</i>	 <i>CEE</i>	 <i>CDN</i>	 <i>CDE</i>
 <i>CGN</i>	 <i>CGE</i>	 <i>CJN</i>	 <i>CJE</i>	 <i>CHN</i>	 <i>CHE</i>	 <i>FCC-V</i>	 <i>FCS-V</i>
 <i>FCC-C</i>	 <i>FCS-C</i>	 <i>FHC-V</i>	 <i>FHS-V</i>	 <i>FHC-C</i>	 <i>FHS-C</i>	 <i>FFC-V</i>	 <i>FFS-V</i>
 <i>FFC-C</i>	 <i>FFS-C</i>	 <i>FFN-H</i>					

For additional information on all profiles, see the Product Offering in **Section 4**.

Engineering Excellence

Engineering support is another feature of the Parker Sealing Solutions Program. Every product group is fully supported by Parker's internal engineering staff. As the leader in seal design engineering, Parker designs sealing solutions for new applications, modifies designs to improve performance and troubleshoots problem applications in addition to designing like replacements.

Quality Commitment

Quality commitment is a feature of the Parker Sealing Solutions Program that we take very seriously. Quality was built around the tough requirements of MIL-I-45208A and MIL-STD-45662 and refined for certification for ISO-9001 and AS-9100. All manufacturing plants are either ISO-9001 or QS-9000 certified to assure consistent quality.

Customer Support

Field Service is provided by over 90 direct factory representatives to keep customers up to date on the latest technologies and provide a wide range of on-site services.

Worldwide and local support is just a phone call away. Your local Parker sales representative provides a single point of contact for local sealing support. Our established worldwide network of over 300 distributor and service center locations, including global sales and engineering, means you can always get quality products when and where you need them. It also means that sound advice from Parker sealing experts is never far away.

Research & Development efforts are continuous and ensure the latest in sealing technology design and materials are available. Testing capabilities allow seal performance to be verified prior to a customer launch of a new product.

Premier Customer Service is a key component of the Parker package. Electronic ordering systems such as EDI and PHconnect make placing and tracking orders easy. For personal contact, our fully trained staff of customer service representatives are only a phone call away at 1-800-233-3900.

Parker Sealing Solutions is a complete program, not just product.

Packaging

Traditional non-fluoroelastomer Clipper Oil Seals are packaged in the blue box.



Fluoroelastomer Clipper Oil Seals are packaged in the brown box.



Parker Oil Seals are packaged in the gold box.



Parker Oil Seals with ParKote™ bore sealant

03/28/06

Applications

Rotary Seals for Steel & Paper Industry



- Backup Rolls
- Mill Stands
- Felt Rolls
- King & Queen Rolls

Rotary Seals for Heavy Equipment



- Mining
- Construction
- HD Reducers

Rotary Seals for Industrial Equipment



- Reducers
- Gearboxes
- Pumps
- Motors
- Bearings

Rotary Seals for Power Generation



- Turbines
- Blowers
- Pumps
- Motors
- Bearings

Bearing Isolators for Industry



- ANSI Pumps
- Electric Motors
- Split Pillow Blocks
- Turbines
- Gearboxes

PTFE Seals for High Performance



- Centrifuges
- Pumps
- Gearboxes
- Mixers
- Instrumentation
- Semiconductor
- Medical Equipment

Sealing Systems

The completeness of Parker’s rotary seal offering allows customers to improve performance by utilizing a sealing system. This approach uses multiple sealing products when requirements exceed the capability of a single seal. Some of the more common systems are pictured below.

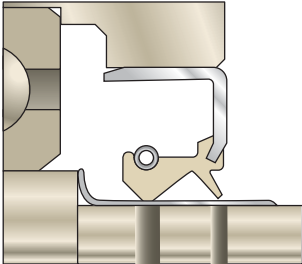

System incorporating lip seal and a shaft repair sleeve

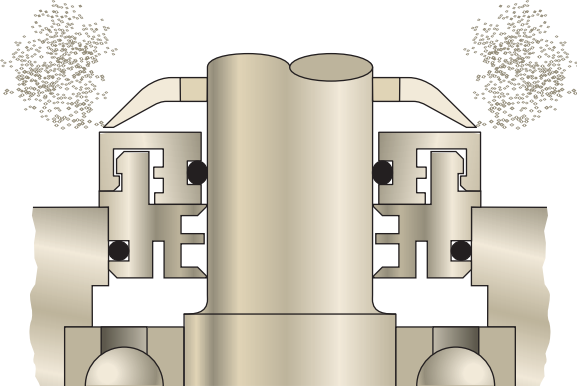

System incorporating SSW slinger and ProTech bearing isolator for optimal exclusion on vertical up application

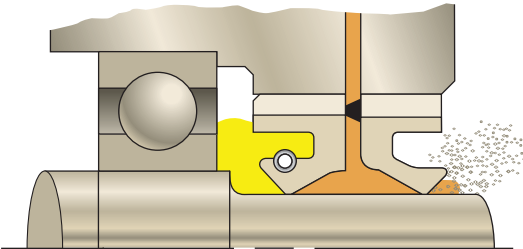

System incorporating two seals back-to-back with grease purge for improved contaminant exclusion and oil retention

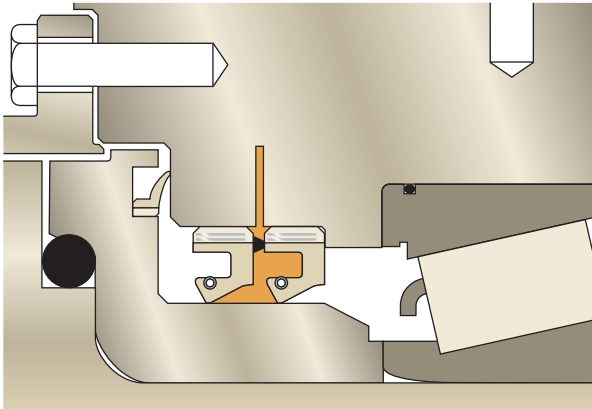

System incorporating two lip seals with grease purge and SSW slinger for maximum exclusion

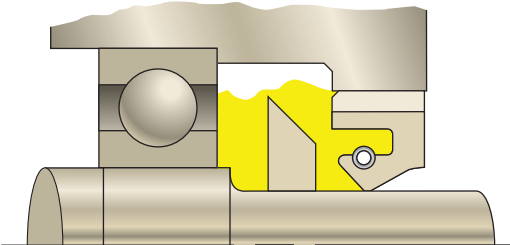

Standard lip seal with internal DS slinger to protect lip from lubricant surge

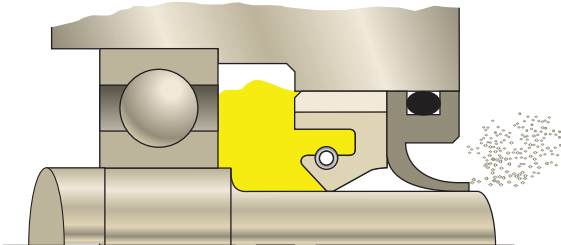

Elastomeric lip seal for oil retention with PTFE lip seal for exclusion

03/28/06



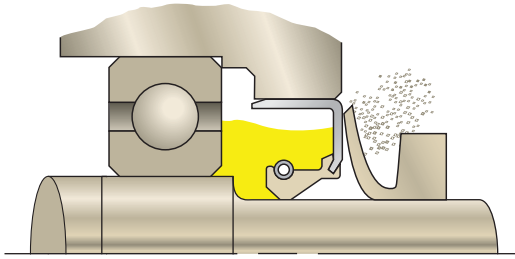

V-Seal used to protect primary oil seal from excessive contamination

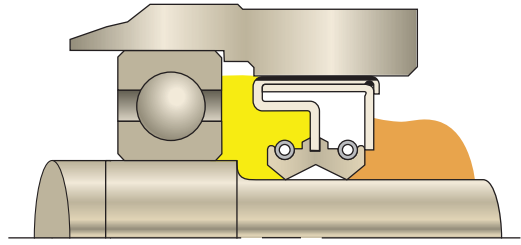

Opposed dual spring-loaded lips for separation of two fluids

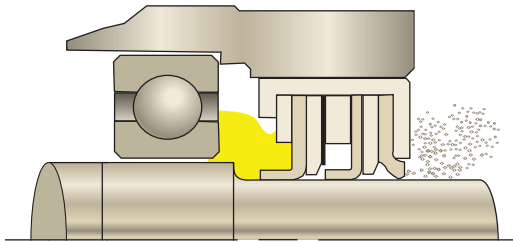

Multi-lip FlexiCase design for sealing high pressure and excluding dust

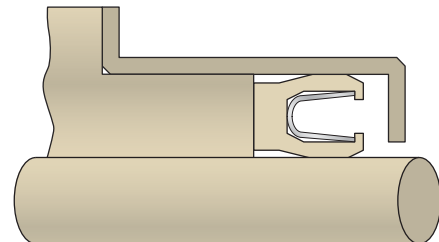

FlexiSeal used in tank cleaner slow speed, 1000 psi

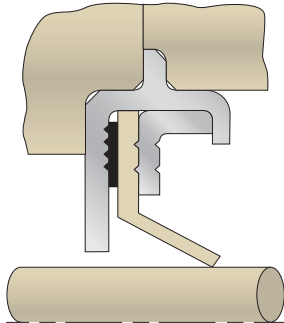

FlexiCase in gas turbine engine sump for high speed, 15,000 sfpm

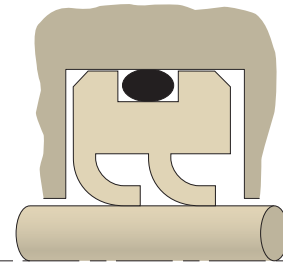

FlexiLip in air conditioning compressor 260 sfpm, 20 - 300 psi

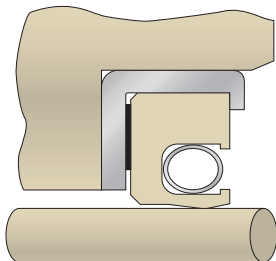

FlexiCase in refrigerant recovery system, 300 psi

03/28/06

Contents

Rotary Shaft Seals

What Is the Purpose of a Seal? . . .	2-1
History of Shaft Seals	2-2
How Do They Work?	2-3
Seal Components	2-4
Lubricant Considerations	2-6
Shaft Considerations	2-6
Testing for Machine Lead	2-7
Shaft Tolerances	2-8
Underlip Operating Temperature . .	2-8
Seal Torque	2-9
Internal Pressure	2-10
Shaft Speed	2-10
Housing/Bore Considerations	2-11
Shaft to Bore Misalignment	2-11
Shaft Runout	2-12
Shaft Seal Summary	2-12
Shaft Seal Installation	2-12
Handling and Storage	2-14

PTFE Shaft Seals

How Do I Choose the Right Profile for My Application?	2-15
Spring Designs	2-16
Lip Shapes	2-20
Shaft Considerations	2-21
Housing/Bore Considerations	2-22
Pressure and Shaft Velocity	2-23
Lubrication	2-24
Rotary PTFE Product Choice	2-24
Shaft Misalignment and Runout . .	2-25
Rotary PTFE Seal Considerations	2-26
Alternate Housing Configurations	2-26

Bearing Isolators

General Theory of Operation	2-27
---------------------------------------	------

Testing and Validation	2-30
----------------------------------	------

Rotary Shaft Seals

What Is the Purpose of a Seal?

Today there is a wide selection of designs available for use in rotary applications. They range from the traditional single and double lip elastomeric configurations to PTFE-based designs. Even more complex designs incorporate multiple lips, differing materials and hybrid labyrinth designs. The purpose of this reference guide is to assist engineers and maintenance professionals in selecting the best design for a specific application based on service life requirements and cost objectives.

One of the most common purposes of a lip seal is to protect the bearing that is used to support a shaft in a rotating application. Retaining the bearing lubricant and keeping it clean ensures maximum bearing life and increases the overall service life of the equipment. Such applications include automotive wheels, electric motors, pumps, gearboxes and large rolls used in steel and paper manufacturing.

Radial lip seals are used throughout industries in a variety of other applications under a wide range of operating conditions. These conditions can vary from high-speed shaft rotation with light oil mist to low speed reciprocating shaft in muddy environments. Radial lip seals can be found sealing lube oil in high speed crankshaft applications for gasoline and diesel engines that operate from the tropics to the arctic, in submarines, oil tankers, spacecraft, windmills, steel mills, paper mills, refineries, farm tractors, appliances and automobiles. In fact, they can be found in anything that has a rotating shaft.



Parker rotary shaft seals retain lubrication and exclude contaminants even in the most extreme environments.

03/28/06

In rotating applications, a seal can also impact the service life of indirect components such as mechanical seals, couplings, pulleys or other in-line coupled equipment. If a seal allows the system lubricant to run below safe levels or allows foreign material to enter the bearing cavity, the bearing will soon begin to show signs of failure. As the bearing fails, vibration from excessive shaft runout will be transferred to all other in-line components and will shorten their service life as well.

The advantages of radial lip seals include: low cost, small space requirements, easy installation and an ability to seal a wide variety of applications.

In review, the primary purpose of the radial lip seal is to retain lubricants within a sump or cavity. The secondary purpose is to exclude contaminants from the system lubricant. Lip seals are also used to separate two different fluids, retain internal pressure or exclude an external pressure.

History of Shaft Seals

The earliest seals were rags and pieces of leather straps tied at the end of cart wheel axles to retain the animal fat or olive oil used at that time for lubrication. This slowly evolved to more complex sealing systems and lubricants, such as grease made with olive oil and lime.

The Industrial Revolution accelerated sealing innovations with bores in the wheel hubs to hold packings and ropes to seal rotating shafts. Higher shaft speeds increased operating temperatures and the development of thinner lubricants demanded constant improvements in seal design. This brought along better braided ropes made by specialists using different impregnations such as waxes and pitch.

In the 1930s, seals with beveled leather washers crimped in metal cases were produced. These assembled seals did not require adjustments and were easy to install and fit in much less space than the packings and stuffing boxes previously used. Leather inserts with taller flexible lips were also used because they were better able to follow the wobble of the shafts.

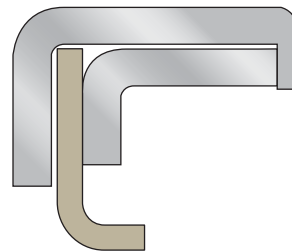

Early seals were made from leather crimped in metal cases.

Springs were added to the leather lip seal in the 1940s. Leather was treated to reduce the seepage of lubricants through the sealing elements, but even with different coatings and impregnations, leather could only work slightly above the boiling point of water, so a better material was needed. The new material became synthetic rubber and was introduced as a lip material during World War II. During the war, copper coating and later chemical coats were used to bond the rubber to metal washers that were assembled in metal cases.

In the 1960s, the bonding became reliable enough that rubber lips were molded directly to the outer case. This eliminated possible leakage from between the assembled components. This was due to the components becoming loose from compression set of the rubber or distortion of the components from assembly into the bore. Leather also remained a common lip material throughout the 1970s.

Today, assembled seals made with leather or rubber are no longer recommended because of their high cost, internal leakage, and lack of dimensional control. Most manufacturers have converted small diameter seals to the bonded design; however, the need to use advanced materials such as thermoplastics (primarily PTFE) that can be difficult to bond to a metal case may still require an assembled case design. Large diameter seals have been much slower to move away from the antiquated assembled design, so extra care should be used when sourcing seals for large diameter applications.

03/28/06

How Do They Work?

Rotary shaft seals work by squeezing and maintaining the lubricant in a thin layer between the lip and shaft. Sealing is further aided by the hydrodynamic action caused by the rotating shaft, which creates a slight pumping action.

Rotary shaft seals provide protection by performing two critical functions. In most applications the primary function of the seal is to retain the bearing or system lubricant. There are thousands of different types of lubricants available today, but in general bearings are either oil or grease lubricated.

The second function of the seal is to exclude outboard material that can contaminate the system lubricant or directly damage the bearing. The type of contamination the seal will need to exclude is dependent on the application. The more common types are moisture and water, and dry materials including dust, sand, dirt or particulates such as those generated by manufacturing processes.

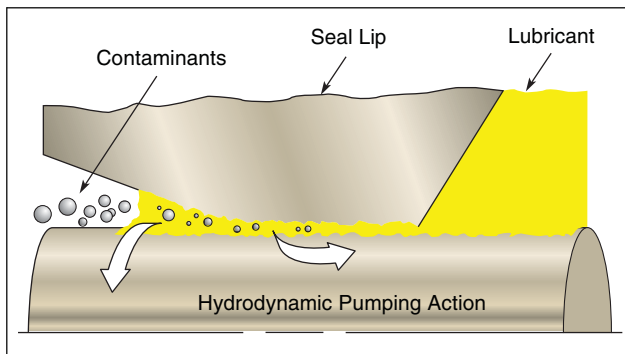

Figure 2-1. Rotary Shaft Seal at Work

The seal's ability to retain the system lubricant and exclude contaminants plays a key role in the service life of equipment components such as bearings, gears and any other component that relies on the system lubricant. The seal can have a dramatic impact on the service life of the system lubricant by retaining the optimal level, reducing exposure to excessive frictional heat and excluding foreign matter.

Typical petroleum oil has a useful life of thirty years at 86 °F (30 °C) if it is not contaminated with water or particulate matter, but the same oil has a life of only a month at 212 °F (100 °C). As little as 0.002% water in oil lubrication can reduce ball bearing life by 50%, primarily through hydrogen embrittlement. Solid particles cause more rapid damage to the bearing race through high-localized stresses and increased frictional heat.

The sliding contact between the seal lip and the shaft will generate friction, increasing the contact temperature beyond the temperature caused by the bearings and other sources. Heat accelerates the breakdown of the oil and starts forming a varnish on the hot spots. Over time, the varnish changes to carbon and builds in thickness as the surrounding oil loses its lubricity. How quickly this happens is dependent on temperature. The deposit can lift and abrade the lip, causing leakage. The time to reach each stage is cut in half for each 18 °F (10 °C) increase in temperature. The heat also accelerates the cure of the rubber, especially at the contact surface between the seal lip and the rotating shaft. Eventually the lip surface hardens, small cracks form and the surrounding rubber stiffens. The cracks get larger and the lip stiffer, until it can no longer follow the movement of the shaft or seal. In order to maximize seal life, it is critical to minimize the amount of frictional heat of the application.

The amount of frictional heat that is generated is a combination of many operating parameters. Shaft surface, internal pressure, operating speed, lubricant type, lubricant level, lip geometry and lip material are just a few of the conditions that need to be considered. It is important to note that these conditions are very interactive. For example, an increase in shaft speed will increase the sump temperature. If not vented, the temperature rise will increase the pressure inside the housing. The internal pressure will push on the seal lip and create additional force between the seal lip and the shaft. In turn, the operating temperature under the seal lip will see a significant rise in temperature and can cause premature seal failure within hours.

03/28/06

It is easy to see why an understanding of rotating shaft seals is critical when trying to reduce the mean time between failure of rotating equipment. To better understand how rotary lip seals work, knowledge of basic seal components is needed.

Seal Components

Typical rotary shaft seal components include a rigid outer component and a flexible inner lip (see **Figure 2-2**). The seal lip can be springless or spring-loaded.

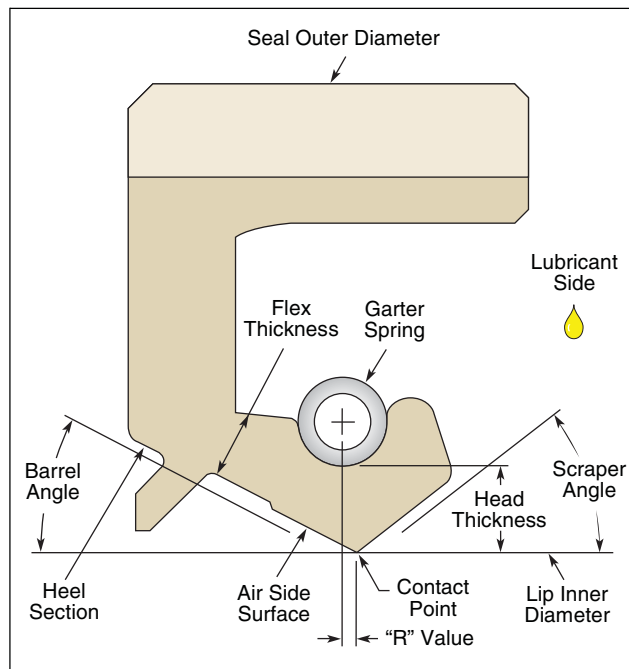

Figure 2-2. Seal Components

The outer rigid material can range from carbon steel, aluminum and stainless steel to a nonmetallic composite as pictured above. The purpose of the outer component is to position and retain the seal in the housing. The seal's outer component must also be able to maintain a leak-free fit between the seal and the housing.

The outside diameter of the seal is larger than the seal housing to create a press fit. The actual seal diameter will depend on the size and material of the seal, the size and material of the housing and expected internal pressure and temperature. For general industry standards on OD press fit, see **Tables 6-2** and **6-3** on **Page 6-3**.

The seal element is attached to the outer rigid material by bonding it as it is cured in a molding press or mechanically crimping a cured element between metal components. Designs that use high performance composite materials for the rigid outer section provide the advantages of a one-piece molded construction. One-piece molded designs and bonded designs should be used whenever possible. Assembled designs (small or large diameter) are easily damaged during handling and installation, causing the assembled components to loosen. This creates leak paths between the various components.

The sealing lip configuration will vary based on the type of service, speed, pressure and dynamic runout for which the seal is designed. The seal geometry may also include hydrodynamic pumping features which are normally molded into the lip element on its air side. Common hydrodynamic patterns are triangular and helical. They function by pumping oil that has passed by the primary lip back under the lip to reduce leakage, extending seal life. Refer to **Section 4** for lip profile options.

The oil side of the seal lip has an angle in the range of 35 to 55 degrees. The air side has a much shallower angle and is typically 15 to 30 degrees. These angles determine the contact footprint of the lip on the shaft. Incorrect angles will form a footprint that cannot maintain a seal with the shaft and explains why heavy leakage occurs if a lip seal is installed backwards, or with the steep lip angle facing away from the oil side.

03/28/06

This also means that the primary function of single spring-loaded designs is dependent on the installation direction. While the seal will perform both retention and exclusion functions, they are not performed equally.

If the primary function is retention, the seal should be installed with the steep lip angle facing towards the lubricant. This is normally the open-faced side. If the primary function of the seal is to exclude, the steep angle needs to face toward the contaminant (see **Figure 2-3**).

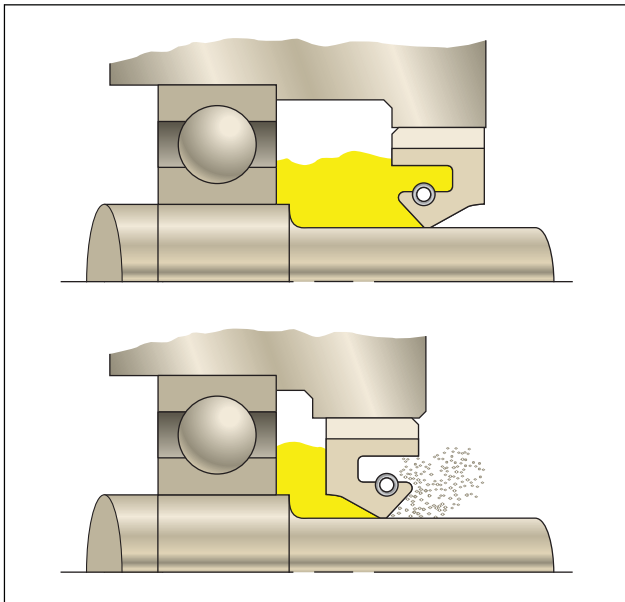

Figure 2-3. Installations Facing Lubricant and Contaminant

If both retention and exclusion are critical and the level of contaminants is heavy, one seal should be used to retain the lubricant, and exclusion capacity should be added using another lip seal, auxiliary excluders or by upgrading to a bearing isolator (see **Page 2-27**).

The purpose of the spring is to provide a constant, uniform load of the lip on the shaft for the life of the seal. The spring keeps the seal lip in contact with the shaft during higher shaft speeds and also overcomes compression set and wear of the lip material. Compression set of the lip material is normal as it is subjected to thermal cycles during operation.

Several spring types are used to energize the lip. The most common is a wound spring, often referred to as a garter spring. Finger springs are another option, although their loading is typically less uniform and they can be subject to severe distortion prior to or during installation, leading to areas of the lip that are not properly loaded. Other spring types used are cantilever, canted-coil and helical which are normally used in PTFE designs. In order for the spring to maintain the proper load over the life of the seal, the spring must be compatible with the fluids and the temperature of the application.

The dimensional relationship between the center of the spring and the lip contact point is called the R value. The leading edge of the lip should be toward the oil side, with the centerline of the spring slightly toward the air side. If the centerline of the spring is too far toward the air side (too positive R value) it will put too much of the lip (wide footprint) in contact with the shaft and cause excessive wear. A spring position that is too close to the lip contact point (negative R value) can cause the lip to become unstable or roll and dump the spring.

A spring-energized lip is required for positive oil retention, but not typically for grease retention (see **Figure 2-4**).

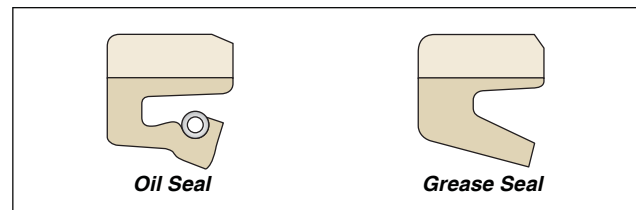

Figure 2-4. Oil and Grease Seals

The rotary shaft seal is only one component in the sealing system. There are several key operating parameters that can work in unison to optimize seal life, or conversely, if misapplied, can reduce seal life to a few operational hours.

Lubricant Considerations

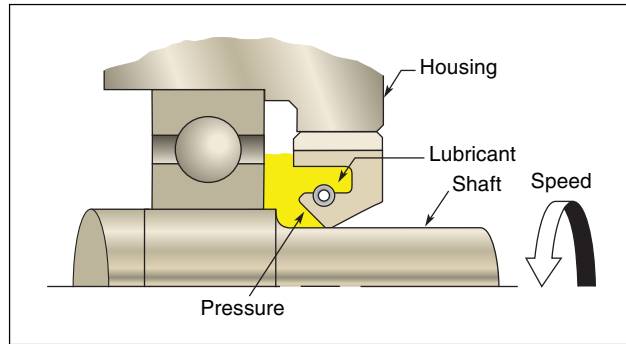

Figure 2-5. Sealing System

The contact lip is designed to run on a thin film of oil. Without the oil film, the seal lip will run directly on the rotating shaft and generate excessive friction and fail within hours. The lubricant selected needs to remain viable over the expected service life. If the underlip temperature exceeds the lubricant rating, carbonization of the oil will occur.

Abrasive carbonized oil particles will build up at the seal lip and accelerate lip and shaft wear. As the oil film becomes less than optimal, the lip friction increases, as does lip wear.

When selecting a lubricant keep the following in mind:

1. Do temperature limits of the lubricant match the underlip operating temperature of the seal?
2. Are the base oil and additives compatible with the lip material?
3. Does the oil level provide adequate lubrication and cooling at the seal lip?

Shaft Considerations

A proper shaft finish provides small pockets to hold the needed oil film between the lip and shaft, preventing direct contact that would otherwise cause friction and wear as the shaft rotates. The shaft surface must also be smooth enough to avoid peaks that are large enough to break through the lubrication film.

The optimal surface for elastomeric shaft seals is a plunge ground finish of 8 to 17 μm Ra (0.20 to 0.43 μm Ra) (0.010" [0.25 mm] cutoff) with a lead angle below 0.05 degrees. (See **Table 2-5** on **Page 2-21** for shaft finish requirements for PTFE seals.)

Recent studies show that the Ra measurement alone is insufficient to quantify a proper surface. The surfaces below have the same Ra finish, but the impact on seal performance will vary.

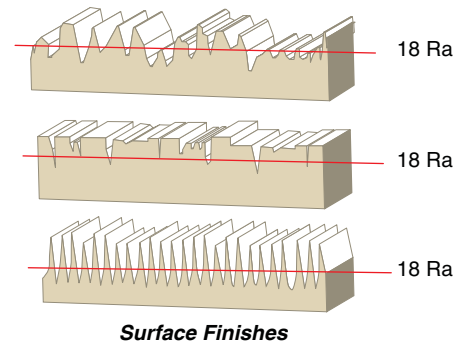

Two additional requirements are needed: Rz (the average peak to valley height) of 65 to 115 μm (1.65 to 2.90 μm), and RPM of 20 to 50 μm (0.5 to 1.25 μm), the average peak to mean height. For additional information, refer to Rubber Manufacturers Association Technical Bulletin OS-1-1.

03/28/06

When a shaft is turned to size, a continuous spiral groove is imparted on the shaft as the cutting bit traverses the shaft. This is called shaft lead.

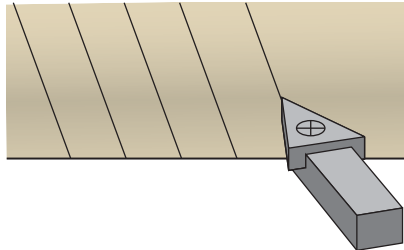

Shaft Lead

If not removed by plunge grinding or other methods, the groove will act as an auger when the shaft rotates. The underlying groove will either pump oil past the seal lip or contaminants into the bearing housing, depending on the direction of the shaft rotation.

If a shaft is going to be plated, the machine lead must still be removed prior to the plating process.

Testing for Machine Lead

When lead is suspect and there is a need for verification in the field, the following field test can be performed:

1. Mount the shaft in a chuck and verify the shaft is level.
2. Lightly coat the shaft with silicone oil with a viscosity of 5 to 10 cps.
3. Drape a thread (unwaxed quilting thread 0.009 inches or 0.23 mm dia.) weighted with a one-ounce (30 g) weight around the shaft and tie the ends together so it is long enough to contact about 2/3 of the circumference of the shaft with the weight hanging. Position the thread so that the knot is not touching the shaft.
4. Rotate the shaft at slow speed, 60 RPM.

5. Place thread at both ends as well as center of shaft and observe for axial movement of the thread under BOTH CW and CCW rotation.

- Movement of the thread in opposite directions, CW versus CCW rotation, indicates lead is present.
- If the thread moves in the same direction under both CW and CCW rotation, verify that the shaft is level.
- If the thread remains stationary when checking the ends and center of shaft under both CW and CCW rotation, significant lead is not present.

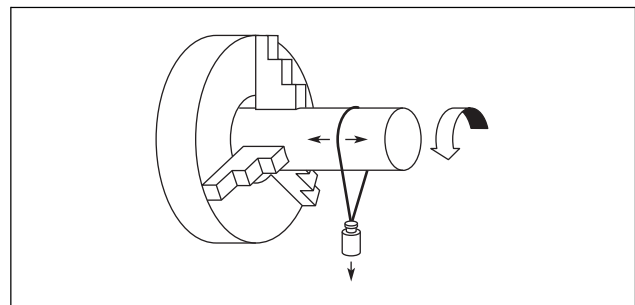

Figure 2-6. Shaft Lead Testing

Please note that this method does not guarantee the absence of lead as some patterns may go undetected using the string test. However, this simple test has been very successful in detecting if a significant lead is present.

The preferred material for the shaft-sealing surface is carbon steel (SAE 1035 or 1045) with a minimum hardness of Rockwell C30 (30 Rc). When heavy amounts of abrasive contamination are present, abrasive additives are used in the lip compound or high-pressure seal designs are going to be used, a minimum shaft hardness of 45 Rc is recommended to resist excessive shaft grooving. Softer materials such as bronze, aluminum or plastic will experience heavy wear (grooving), and should be avoided.

Shaft Tolerances

Shaft diameters should be held to the tolerances specified below:

Table 2-1. Shaft Tolerance for Inch/Fractional

Shaft Diameter	Tolerance
Up to 4.000"	± .003"
4.001 – 6.000"	± .004"
6.001 – 10.000"	± .005"
Over 10.000"	± .006"

Table 2-2. Shaft Tolerance for Metric*

Shaft Diameter	Tolerance
Up to 10 mm	+0 to -.09 mm
Over 10 – 18	+0 to -.11 mm
Over 18 – 30	+0 to -.13 mm
Over 30 – 50	+0 to -.16 mm
Over 50 – 80	+0 to -.19 mm
Over 80 – 120	+0 to -.22 mm
Over 120 – 180	+0 to -.25 mm
Over 180 – 250	+0 to -.29 mm
Over 250 – 315	+0 to -.32 mm
Over 315 – 400	+0 to -.36 mm
Over 400 – 500	+0 to -.40 mm

*ISO Standard 286-2, h11

The leading edge of the shaft should have a burr-free chamfer to ease installation by preventing lip roll-back, spring dumping and damage (nicks or cuts) to the seal lip. Both ends of the chamfer should be free of sharp edges. Spring dumping can occur during seal installation when the lip rolls back on itself, causing it to fall out of the spring pocket. Heavy shock loads that can occur when installing a metal cased seal using a direct blow from a metallic driving tool can also force the spring out of the spring pocket and is also referred to as spring dumping.

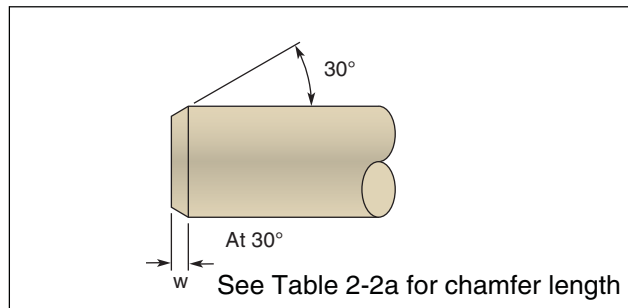
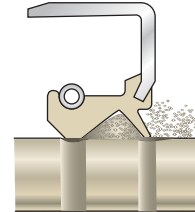

Figure 2-7. Shaft Profile

Special precautions should be taken when replacing a seal over a used shaft because it is common for shafts to become grooved during service. Grooving is normally caused by either carbonized oil or an abrasive foreign matter getting trapped between the lip and the shaft. Over time, deep grooves can form.



Shaft Grooving

Replacement seals should never be installed over a grooved shaft. Dressing the shaft with emery cloth is not recommended because it is extremely difficult to obtain an optimal finish and lead will normally be imparted. If the shaft is worn, it should either be re-ground or fitted with a shaft repair sleeve. See **Section 7** for shaft repair options.

Underlip Operating Temperature

When selecting a seal design, lip material and system lubricant, the operating temperature under the seal lip should be used as the upper limit rather than using the sump temperature.

Underlip temperature can exceed sump temperature by 60 °F (33 °C) or more, dependent on shaft diameter, shaft speed, fluid type and level. The increased temperature can exceed the limits of both the lip material and lubricant that is selected based on the sump temperature alone.

Table 2-2a Min. Chamfer Length

English Shaft Dia Up To And Including	Length "w" (inch)	Metric Shaft Dia Up To And Including	Length "w" (mm)
0.375	0.051	10	1.3
0.750	0.068	20	2.0
1.250	0.085	30	2.2
1.500	0.102	40	2.6
2.000	0.119	50	3.0
2.750	0.136	70	3.5
3.750	0.153	95	3.9
5.000	0.188	130	4.8
9.000	0.239	240	6.1
+18.000	0.375	480	10.0

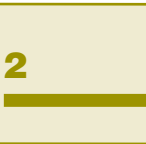

Other operating parameters such as a rough shaft finish or internal pressure will drive the underlip temperature even higher. As a general rule, the °F increase in underlip temperature above the sump temperature can be estimated as the square root of the shaft speed in feet per minute. (Replace the feet per minute units with °F.) This would be 55 °F (30 °C) for a shaft running at 3000 fpm (15 m/s).

$$\sqrt{\text{Shaft Seal in fpm}} = \text{Increase Underlip Temperature}$$

$$\sqrt{3000 \text{ fpm}} = 55 \text{ }^\circ\text{F}$$

As sump temperatures increase, the difference between sump and lip temperature decreases.

Figure 2-8 shows the relationship of shaft diameter, shaft speed and sump temperature and the impact they have on the temperature at the contact point of the seal lip and the shaft (underlip temperature).

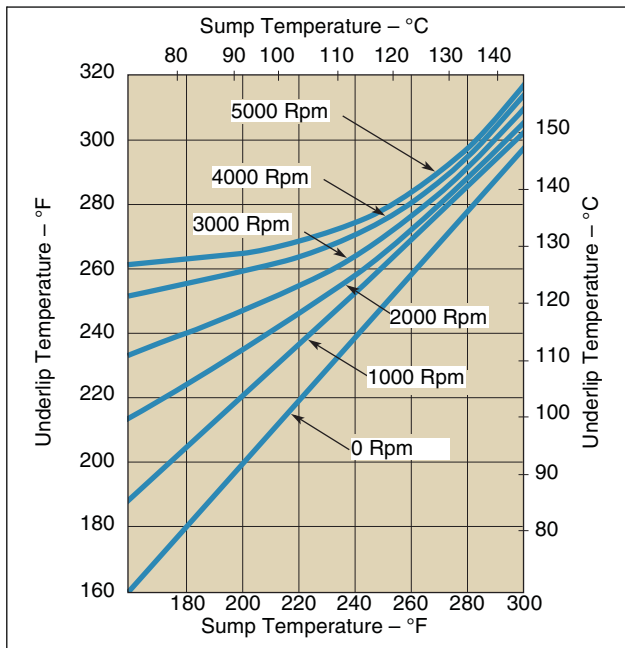

Figure 2-8. Example Shaft Conditions

An easier but more crude estimate is 20 °F (6.7 °C) higher than the sump for each 1,000 RPM of shaft speed for sump temperatures about 75 to 210 °F (24 to 99 °C).

Seal Torque

The underlip temperature increase is due to the friction between the shaft and seal lip. Torque is the frictional force the shaft must overcome to rotate in the seal. The energy consumption of the seal can be determined when the torque and shaft speed are known. Different seal designs, rubber compounds, fluids, fluid levels, temperatures, shaft textures, pressures and time in service each affect friction, so there is no exact calculation to predict torque. However, the following can give an approximate value for elastomer shaft seals. When the torque value is critical for the application, testing should be performed.

$$\text{Seal Torque in-ounces} = 0.65 \times (\text{Shaft Dia. in inches})^2 \times \text{Rpm}^{1/3}$$

Torque from a dry running seal is 2 to 3 times the above.

For example: Torque is about 90 in-ounces for a three-inch shaft rotating at 3600 revolutions per minute in 250 °F SAE 30 weight oil to the shaft center. The energy in kilowatts the seal uses is $7.395 \times 10^{-7} \times \text{torque} \times \text{revolutions per minute}$. In this case, 0.24 kW.

Bearing isolators are an excellent choice when low torque is required because they add virtually no torque to the system.

Internal Pressure

Most elastomeric lip seals are designed to work in vented applications with zero internal pressure but will provide satisfactory service with pressures up to 3 psi (0.20 bar). Higher pressure will force the lip against the shaft and cause excessive friction. Severe pressure will distort and force the airside of the lip to contact the shaft and can cause massive failure within hours of operation. See **Figure 2-9** below. Excessive pressure can also push the seal out of the housing.

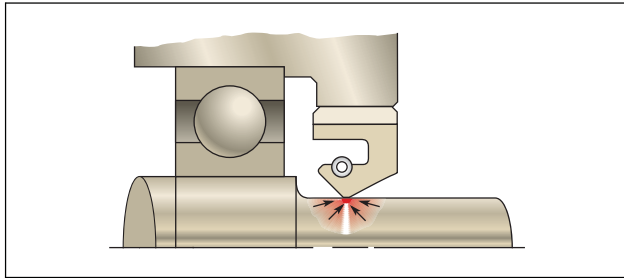

Figure 2-9. Internal Pressure

Parker offers several designs for applications where high internal pressure cannot be avoided. Elastomeric designs include MP, HP, NTC, TDN, and depending on design, can handle service up to 300 psi (20 bar). Refer to **Pages 5-13** and **6-11**.

Most PTFE designs can handle pressure, some up to 10,000 psi (690 bar). See **Tables 9-4, 10-4** and **11-4**.

Shaft Speed

Shaft seals operate in a wide range of speeds. When shaft speeds increase, so does underlip temperature, wear and internal pressure, if oil sumps are not vented. To assure optimal performance, select the proper seal design and material to accommodate for these factors.

Most seal manufacturers rate the speed limit using surface feet per minute (or meters per second). This is a measurement of how many surface feet (meters) pass a given point at the seal lip per minute (second) in time. Since this method considers the shaft diameter in addition to speed, it is a better service indicator than RPM alone.

The formulas below can be used to determine the fpm (feet per minute) or m/s (meters per second) for metric applications.

Inch

$$\text{Shaft Diameter} \times \text{RPM} \times 0.262 = \text{fpm}$$

Metric

$$\text{Shaft Diameter (mm)} \times \text{RPM} \times 0.000523 = \text{m/s}$$

A typical seal design in NBR material can operate up to 3,000 fpm (15 m/s) assuming all other operating parameters are reasonable. If any of the other operating conditions are excessive, seal designs and material upgrades are available to improve performance. Parker FKM and PTFE seals can be used for applications approaching 6,000 fpm (30 m/s) and ProTech bearing isolators for even higher speeds.

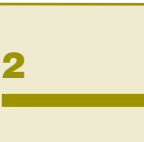

Housing / Bore Considerations

Typical radial shaft seals are pressed into the bore to assure proper OD sealing and seal retention in the housing. The most commonly used materials for seal housings are steel and cast iron. Care must be taken when softer materials such as aluminum, bronze or plastics are used for the housing material. Aluminum has a thermal expansion rate almost double that of steel. Steel case designs can lose the required press fit in an aluminum housing when they go through thermal cycles.

A seal with an aluminum, composite or rubber covered OD should be used for aluminum housings. These materials help maintain the press fit in the housing during thermal cycles and reduce the possibility of galvanic corrosion. Plastic housings can also expand at rates that can create problems if a metal OD seal is used.

The following chart shows typical values of thermal expansion for common metals in inch/inch/°F.

Table 2-3. Typical Values of Thermal Expansion

Item	Value
Aluminum	0.000013
Brass	0.000011
Carbon Steel	0.0000058
Cast Iron	0.0000059
Stainless Steel	0.000010

Fiber reinforced and rubber OD seals are more forgiving so their bore tolerance can be greater than for metal OD seals. Aluminum bores are typically smaller than steel bores for metal OD seals to compensate for some of the difference in thermal expansion. A finish range of 40 to 100 $\mu\text{in Ra}$ (1.0 to 2.5 $\mu\text{m Ra}$) is recommended for service pressures up to 3 psi (0.20 bar). If the fluid is thick, such as a grease, a 125 $\mu\text{in Ra}$ (3.17 $\mu\text{m Ra}$) finish would be acceptable with no system pressure.

The finish on aluminum bores is more sensitive and must be maintained to keep seals from spinning in the bore and should not be smoother than 60 $\mu\text{in Ra}$ (1.5 $\mu\text{m Ra}$).

A lead-in chamfer is highly recommended for all seal housings. The chamfer aligns the seal during installation and helps prevent the seal from cocking. Both corners of the chamfer should be free of burrs and sharp edges.

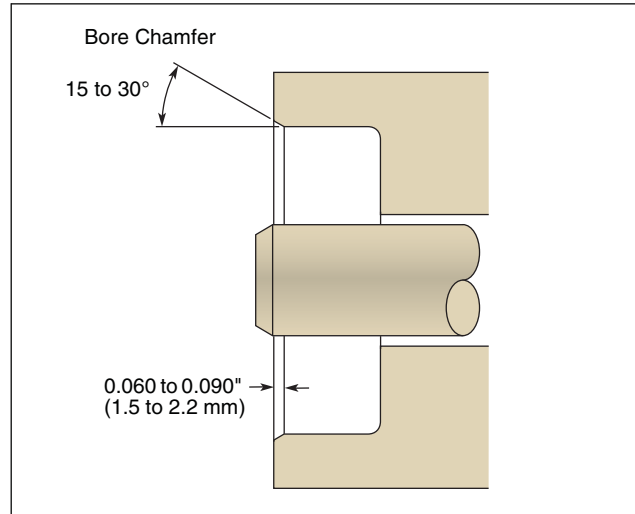

Figure 2-10. Housing Profile

Shaft to Bore Misalignment (STBM)

When the center of the shaft rotation is not the same as the center of the bore, the shaft pushes against the lip on one side of the seal greater than the other. This can cause the lip to wear rapidly in one place and have inadequate contact on the opposite side.

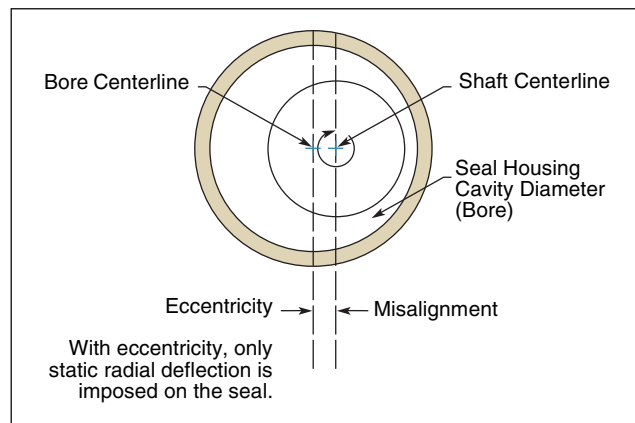

Figure 2-11. STBM

Shaft Runout

When the shaft does not rotate around its center, it wobbles. This condition is called runout. The seal lip has to move back and forth to maintain contact. The life of a seal is shortened as the runout is increased, and when the runout exceeds the capability of the lip, it will leak.

Parker offers seals for misalignment conditions. See **Pages 5-15** and **6-17**.

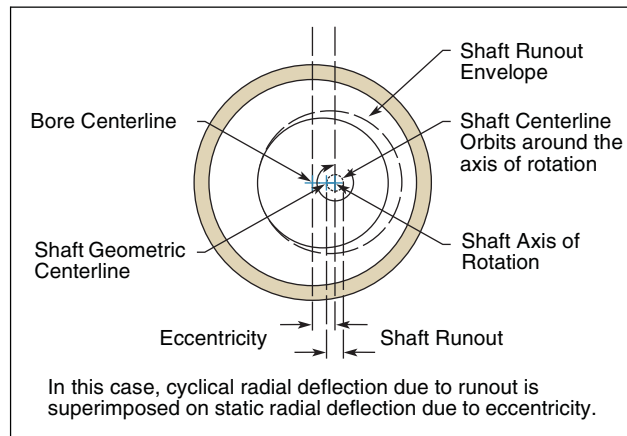

Figure 2-12. Shaft Runout

Shaft Seal Summary

In conclusion, because the seal is only one component of the sealing system, all the following operating factors need to be considered for optimal seal life:

Lubrication: A seal is designed to run on a film of oil. Without the film of oil, the sealing lip will harden and crack due to the heat generated by excessive friction. The lubricant must also be compatible with underlip temperatures to avoid the buildup of abrasive, carbonized particles at the seal lip.

Shaft Finish: A shaft finish that is too smooth will cause a stick slip flutter that will let the fluid escape under the lip and cause excessive heat that will harden the lip. Excessive roughness will penetrate the lubricant film, cause leakage and accelerate lip wear. Maintaining the desired surface finish is critical for maximizing the service life of any contact rotary lip seal.

Shaft to Bore Eccentricity: When the center of the shaft rotation is not the same as the center of the bore, the shaft pushes against the lip on one side of the seal greater than the other. This can cause the lip to wear rapidly in one place and have inadequate contact on the opposite side.

Dynamic Shaft Runout: When the shaft does not rotate around its own center, the lip has to move back and forth to follow it. In excess, the lip will be unable to maintain contact as the shaft rotates, causing leakage.

Pressure: Excessive pressure will force the lip against the shaft and cause excessive frictional heat and wear.

Bore: A bore finish that is too coarse can cause a leak path by itself. If it has burrs or other sharp edges, they can scar the metal diameter during assembly, causing a leak path on the seal OD.

Speed: Shaft speed causes the underlip temperature to increase in addition to elevating the overall sump temperature. Over time, the heat will harden the elastomeric lip and reduce the seal's ability to maintain positive contact with the entire circumference of the shaft.

Operating Temperature: Controlling the temperature of the sealing system is key to maximizing seal life. The relationship between speed, sump temperature, underlip temperature, pressure and shaft finish need to be considered since these operating parameters are interactive and will determine the service life of both the lip material and system lubricant.

Shaft Seal Installation

1. Prior to installation the seal should be examined to ensure that it is clean, undamaged and the correct seal for the application.
2. Verify spring is present for spring-loaded seal designs.
3. Prelubricate the seal lip with a system-compatible lubricant. It is preferable to use the system lubricant.
4. For seals with a rubber outside diameter, lightly lubricate seal OD with a system compatible lubricant. **DO NOT LUBRICATE THE OD OF A CLIPPER OIL SEAL THAT HAS A COMPOSITE OD.**

03/28/06

5. Verify the desired lip direction for the application (lip toward oil for best retention).

6. Examine the leading edge of the shaft. Shaft should be properly chamfered and free of nicks and burrs that could cut or nick the seal lip.

7. Examine the leading edge of the housing. The seal bore should be chamfered and free of nicks and burrs that could gouge the seal outside diameter or make the seal difficult to install into the seal housing.

8. Examine the shaft where the lip will make contact. This surface must be free of grooves from prior service. If shaft is damaged or worn in this area, dress shaft for proper finish or install a Quick Sleeve or wear sleeve. If using a Quick Sleeve, an oversized seal is not required. If using a standard wear sleeve, the replacement seal must have an inside diameter that is designed to be used with the wear sleeve's outside diameter.

9. If the seal lip must pass over keyways or splines on the shaft, use an installation sleeve to protect the seal lips as they pass over these areas. If an installation sleeve is not available, wrap masking tape around the shaft to form a protective barrier.

10. Slide the seal over the shaft to the seal housing. With finger pressure, start seal into housing with a slight rotating motion until seal has a light press fit in the housing. Be sure seal is square or perpendicular to the shaft. If the seal is crooked or cocked, continuing with installation will damage the seal.

11. Position the installation tool and drive the seal into the housing until it is flush with the housing or recessed into the bore the proper distance. Please note that a screwdriver, punch or hammer should not be used to install the seal. Refer to the diagrams at right for recommended installation tools.

12. When using a metal driver to install metal clad seals, extra care is needed to be sure the shock load does not dislodge the spring.

13. If the seal is cocked in the housing, remove seal and start over using a new seal. Attempts to square the seal in the housing using direct blows will damage the seal.

14. Inspect the seal to be sure it is straight and flush. Examine the face of the seal for damage. If it is dented from installation, the lip will be deflected and will normally cause premature failure.

Counter Bore Installation — Flush Mount

Tool bottoms out against machined face of housing to position seal.

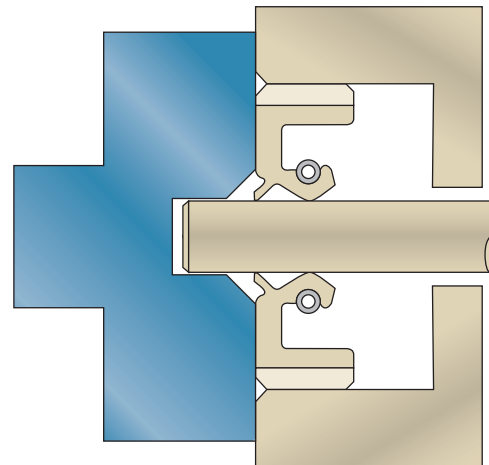

Counter Bore Installation

Seal is positioned square by seating against counter bore.

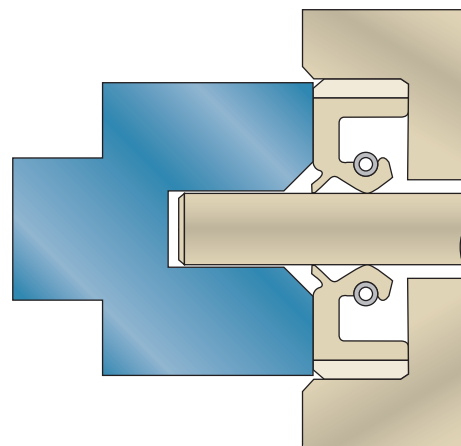

03/28/06

Recessed Installation

2 Tool bottoms out against end of shaft to position seal in the housing.

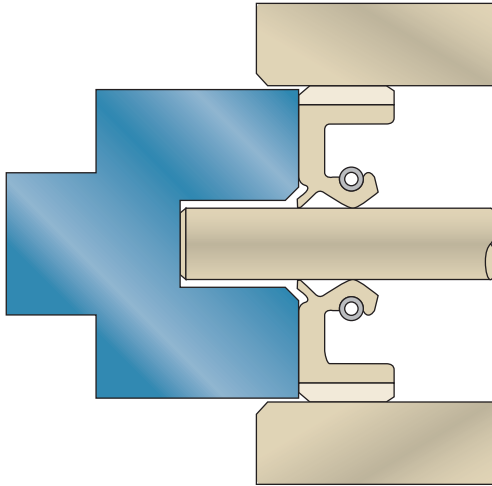
**Installation Sleeve**

Use to install seal over keyways and splines.

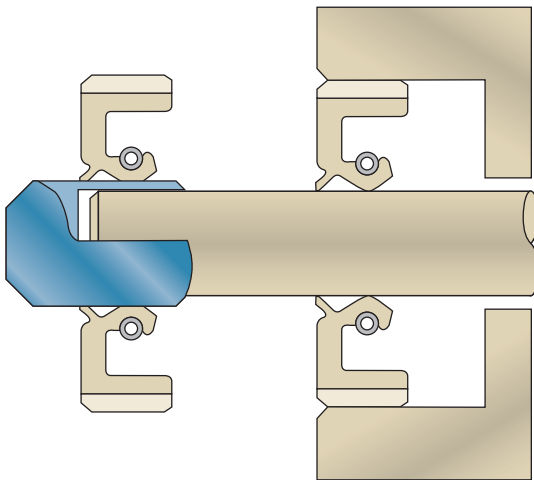
**Handling and Storage**

1. Care should be taken when storing rotary shaft lip seals to ensure optimal performance.

2. Seals should be stored in a cool, dry area below 86 °F (30 °C) with an average relative humidity of 40 to 70%.

3. Rotating stock is important. If inventory is old, seals should be used on a "first in, first out" basis. Based on the relative low cost of a lip seal compared to the expense associated with a failed piece of equipment, a good practice is to discard aged inventory since old seals may have deteriorated lip materials.

4. Seals should be stored away from direct or reflected sunlight and electrical equipment to avoid UV and ozone aging of the lip material.

5. Avoid storing seals in damp areas or where high humidity is present. Excessive humidity will deteriorate some seal element materials. Metal cases and springs will also rust and corrode if exposed to high levels of moisture or humidity.

6. Seals should not be exposed to radiation.

7. Keep seals stored in proper packaging. Do not store unpackaged seals on the shelf.

8. Do not use wire or string to tag a seal. Wire can easily cut the seal lip. Wire or string can also deform the lip beyond the point of recovery and can lead to leakage at start-up.

9. Do not store seals on hooks, nails or pegboard. Over time the weight of the seal resting on the hook will deform the lip beyond recovery.

10. Avoid storing seals where high levels of fumes are present. Depending on the chemical and concentration, it can chemically interact with the lip material.

03/28/06

PTFE Shaft Seals

How Do I Choose the Right Profile for My Application?

Parker's PTFE product line includes both standard designs for the most common applications and custom designs that our engineers can help you develop.

For the long term, we suggest that you familiarize yourself with the design elements in this Engineering section that are critical when choosing a FlexiLip™, FlexiCase™ or FlexiSeal®.

For quick reference and ease of sorting through the many standard designs, we have provided simple decision trees and placed them throughout this design guide. If it becomes apparent that you need a custom design to meet your unique needs, or if you just want us to confirm the standard seal choice you've made, please contact Parker's PTFE Engineering team at 801-972-3000.

Parker designs and manufactures a complete line of PTFE seals for both reciprocating and rotary applications. This guide focuses on seals for rotary applications. For reciprocating applications please refer to publication EPS 5340 *PTFE Lip Seal Design Guide*.

PTFE lip seals are commonly used as an upgrade over elastomeric lip seals when conditions are severe. Common reasons for upgrading to a PTFE material include chemical compatibility, poor lubrication at the lip, high pressure, high speed or high temperature.

For rotary applications, Parker offers three primary design groups: FlexiLip, FlexiCase and FlexiSeal.

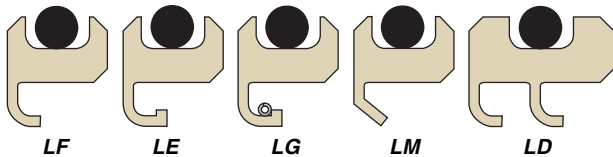

FlexiLip seals are available in the above basic profiles. Excluder lips and internal metal stabilizer bands can be added to each profile depending on application requirements. The main difference is the shape of the primary lip. Additional options are available for the lip and O-ring material for added design flexibility.

- LF = Mandrel Formed Lip
- LE = Elf Toe Lip
- LG = Lip With Garter Spring
- LM = Machined Lip
- LD = Dual Lip

FlexiLip seals are intended for continuous running rotary shafts under various operating conditions. An O-ring is used on the OD for positive static sealing and proper bore retention. Typical operating limits are up to 6,000 sfpm, 150 psi and 450 °F (30 m/s, 10 bar and 232 °C). See **Table 9-4** on **Page 9-10** for specific limits.

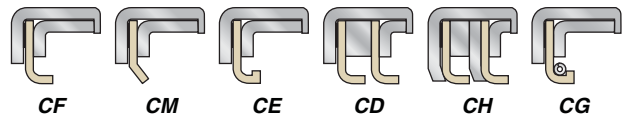

FlexiCase designs feature PTFE lip elements encased in a metal jacket and are available in the above basic profiles. FlexiCase designs can be used in the same applications as FlexiLip profiles where more bore retention is required. Excluder lips can be added for additional exclusion capacity. Additional options are available for the lip and case material for added design flexibility. Typical operating limits are 6,000 sfpm, 500 psi and 450 °F (30 m/s, 34 bar and 232 °C).

- CF = Mandrel Formed Lip
- CM = Machined Lip Form
- CE = Elf Toe Lip
- CD = Dual Lips
- CH = High Pressure Dual Lip
- CG = Lip With Garter Spring

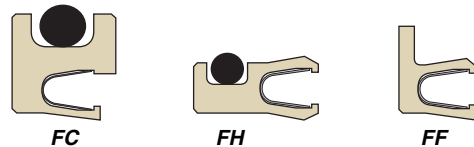

FlexiSeal rotary seals are spring-energized designs and are available in the basic profiles above. Three spring options are available for each profile: cantilever, canted-coil and helical. Shaft speeds are very limited (below 1,000 sfpm or 5 m/s) but they can provide positive sealing to 10,000 psi (690 bar). This is the preferred design for rotating unions as well as oscillating and slow rotating shafts under high pressure conditions.

03/28/06

2

Spring Designs

FlexiSeal profiles utilize three different spring designs.



V Series — Cantilever



C Series — Canted-Coil



H Series — Helical

The two elements to consider when selecting a spring design are its load value and its deflection range. The spring's load affects the sealing ability, friction and wear rate. As the spring load is increased, the lips seal tighter, with friction and wear increasing

proportionately. The spring's deflection range affects the seal's ability to compensate for variations in gland tolerances and for normal seal wear. Each spring size has a specific deflection range. The available deflection increases as the seal and spring cross-section increase; this could be a deciding factor in selecting one cross-section over another. Springs with a wide deflection range should be used when sealing surfaces are nonconcentric (see **Page 2-25**).

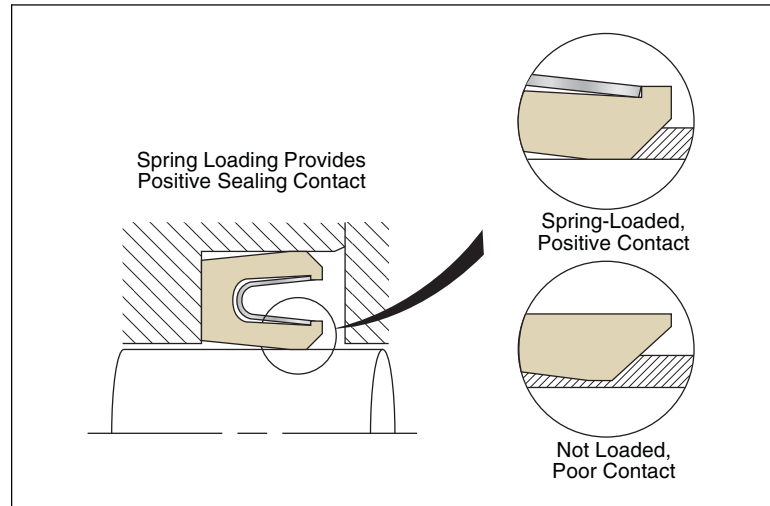

Figure 2-13. Spring Loading

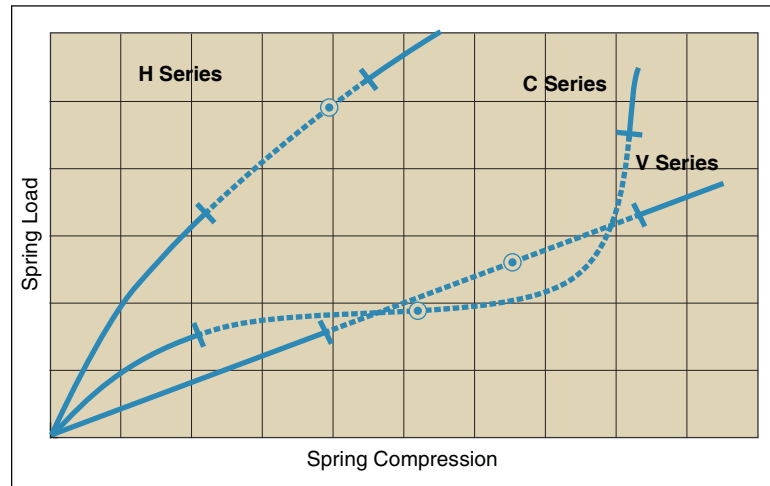

Figure 2-14. FlexiSeal Spring Energizers

Figure 2-14 shows a relative comparison of load vs. deflection curves for the three spring types. The ● signifies the typical deflection when the seal is installed. The hatch marks indicate the deflection range through which the seal will function properly. Notice that H Series has a much smaller deflection range than both the V and the C Series.

03/28/06

Cantilever Springs — V Series

The FlexiSeal Cantilever spring is made from flat metal strip stock of 300 Series stainless steel or Elgiloy®* as an option. The strip stock is punched or chemically etched into a serpentine pattern and formed into a rounded “V” shape. It is available in either a light or medium load spring. The medium spring is suitable in most applications, but the light load spring can be used if having low friction is more important than sealability. The medium spring load deflection curve is depicted in **Figure 2-14** on **Page 2-16**.

The cantilever spring is intended for dynamic applications involving rotary or reciprocating motion. It can also be used in static conditions when there is need for a higher deflection spring due to wide gland tolerance, excessive expansion and contraction, or lift-off due to high pressure.

The long beam leg design puts the spring load out at the leading edge of the seal, creating the best load location for the FlexiSeal to act as a scraper when the optional scraper lip is selected.

The geometry of the V Series cantilever spring provides flexibility by utilizing individual tabs, separated by small gaps. This shape allows the spring to flex into radial and axial seal designs. The spring tabs can overlap on the ID and spread apart on the OD when the cross-section is too large for the diameter.

Table 2-4 provides the minimum diameters for V Series springs for rod and piston seals, as well as internal and external pressure face seals. For diameters smaller than those listed, C or H Series spring designs are recommended.

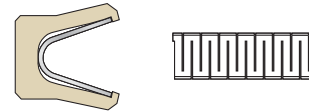

V Series / Cantilever

Table 2-4. Minimum Diameters for V Series

Nominal Cross-Section	Rod Shaft Dia.	Piston Bore Dia.	Internal Pressure (Seal OD)	External Pressure (Seal ID)
1/16	0.125	0.250	0.750	0.500
3/32	0.187	0.375	1.250	0.875
1/8	0.375	0.625	1.750	1.125
3/16	0.875	1.250	2.250	2.000
1/4	1.625	2.125	3.500	3.000

Features

- V-shaped spring with moderate load vs. deflection
- Standard inch/fractional and MIL-G-5514 sizes
- Standard 300 series stainless steel springs
- NACE compliant Elgiloy springs available in medium spring load, -450 to 600 °F
- Scraper lip designs for abrasive medias
- Available as external & internal pressure face seals

Recommended Applications

- Reciprocating rods & pistons
- Rotary shafts <1000 sfpm
- Wide tolerance and misaligned glands (static)
- Abrasive medias (when scraper lip is designated)
- Dynamic applications above 450 °F

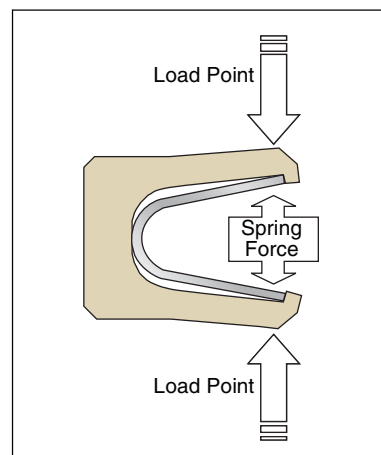

Figure 2-15. Installed State

*Elgiloy® is a registered trademark of Combined Metals of Chicago, LLC, Chicago, IL.

Canted-Coil Springs — C Series

The FlexiSeal C Series spring is made from round wire that is coiled and formed into a canted or slanted shape. The result is a radial compression spring with a very flat load versus deflection curve as illustrated in **Figure 2-14** on **Page 2-16**. Both 302 stainless steel and Hastelloy® C-276 are available as standards in three different spring loads.

The canted-coil spring is intended for dynamic reciprocating and rotary applications. It is also used in static applications when wide gland tolerance or misalignment is present. The flat load curve of this design makes it an ideal choice for friction sensitive applications.

The C Series spring can be fit into small seal diameters without overlapping the individual spring coils. Because the ID coils tend to butt up to each other, the spring has very small gaps providing maximum spring contact. This geometry is well suited for dynamic rod seal applications less than 1/2" diameter.

The C Series spring is available in Light, Medium and Heavy load ranges.

- **Light:** Applications that require extremely low break-out and running friction when sealing ability is less important than friction.
- **Medium:** General application. Medium friction but reliable sealing capability. Normally the starting point for new applications. Balance functions of friction, sealing ability and dynamic wear.
- **Heavy:** Applications where optimum resilience is required due to hardware separation. Accelerated seal material wear in dynamic applications. Used when primary objective is sealing and friction and/or wear is secondary.



C Series / Canted-Coil

The C Series spring produces compression load near the center of the seal. The standard beveled lip seal geometry puts the point of contact slightly in front, forcing the spring back into the spring cavity. The lip design provides concentrated unit load at the sealing interface, and allows lubrication to the dynamic lip, increasing the wear life. Because of this geometry, the C Series is not the best choice for abrasive medias. For abrasive conditions the FlexiSeal V Series is recommended. See **Page 2-17** for details.

Features

- Canted coil spring with flat load vs. deflections
- Light, medium and heavy load springs standard
- Standard inch/fractional and MIL-G-5514 sizes
- Standard 302 series stainless steel springs
- Hastelloy springs available
- Available as external & internal pressure face seals

Recommended Applications

- Friction sensitive applications
- Reciprocating rods & pistons
- Rotary shafts <1000 sfpm
- Wide tolerance and misaligned glands
- Dynamic applications above 450 °F
- Diameters <1/2" and cross-sections <3/32"

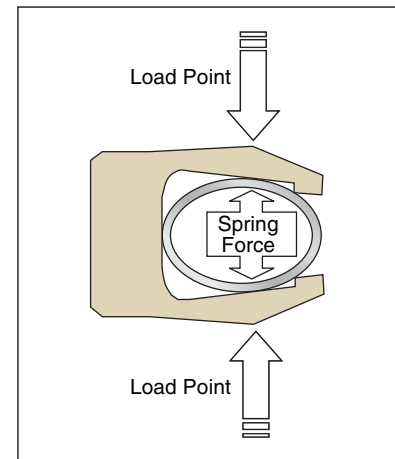

Figure 2-16. Installed State

*Hastelloy® is a registered trademark of Haynes International, Inc., Kokomo, IN.

Helical Springs — H Series

The H Series spring is made from flat ribbon metal strip stock that is formed into a helix shape. The standard material is 17/7 PH stainless steel, and Elgiloy® is offered as an option. The finished spring produces a very high load versus deflection curve as shown in **Figure 2-14** on **Page 2-16**.

The helical spring design is intended for static applications due to the high unit load. It can be used in very slow or infrequent dynamic conditions when friction and wear are secondary concerns to positive sealing.

The H series spring produces evenly distributed load across each individual band, with very small gaps between the coils. This tight spacing provides near continuous load, reducing potential leak paths. This, combined with the high unit load, makes the H series well-suited for vacuum and cryogenic applications or when pressure is too low to energize the seal.

The load provided by the H Series spring is directly through its centerline. The lip design of the FBN-H profile is a full radius at the sealing interface, providing maximum load to the contact points to effect a tight seal. The spring is welded at the ends. When the seal is compressed into the hardware, the spring cavity is designed to allow axial spring growth.

The relatively small deflection range of the H Series spring prevents it from being used in applications having wide gland tolerances, eccentricity or misalignment. The V or C Series FlexiSeal should be considered for these conditions.



H Series / Helical

Features

- Helical wound ribbon spring with high load vs. deflection
- Standard inch/fractional and MIL-G-5514 sizes
- Standard 17/7 PH stainless steel springs
- NACE compliant Elgiloy springs available
- Available as external & internal pressure face seals

Recommended Applications

- Static rods & pistons
- Static internal & external pressure face seal applications
- Slow dynamic applications <200 sfpm
- Vacuum sealing
- Applications where sealing ability is critical

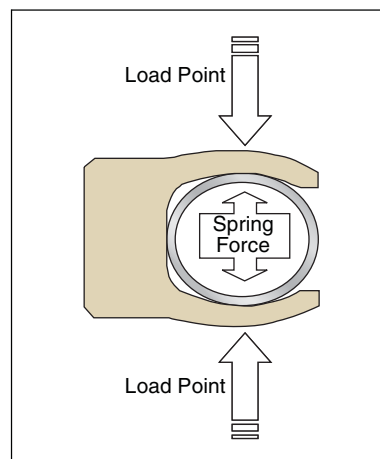
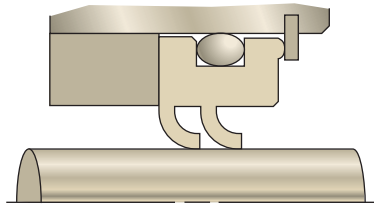
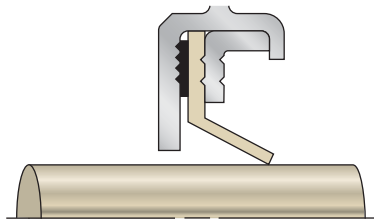

Figure 2-17. Installed State



Formed Lip



Machined Lip

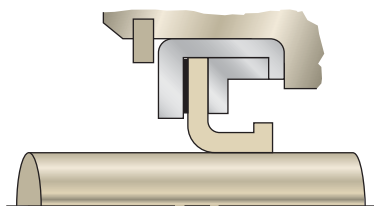

Elf Toe Lip without Spring

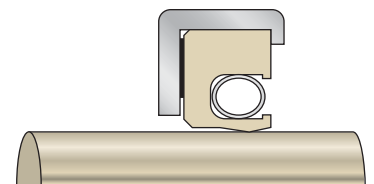

Chamfered Lip

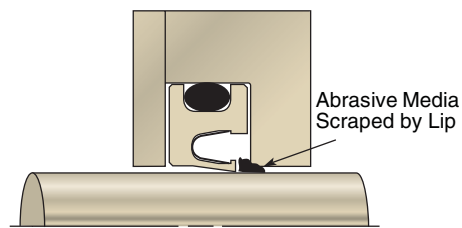

Scraper Lip at ID

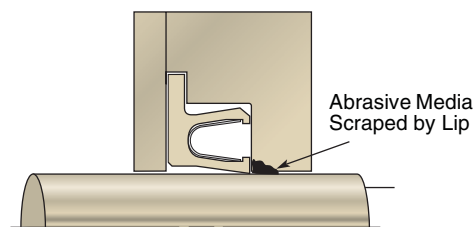

Flanged Scraper Lip at ID

Lip Shapes

Formed Lips — The formed lip is the most common profile for general rotary service. After the lip is machined to size, a mandrel is used to form the lip to the desired interference to achieve the optimal lip load. Both FlexiLip and FlexiCase designs are available with single or multiple formed lips. Formed lips are used to retain lubricant, can handle pressure up to 150 psi (10 bar) and are rated for shaft speeds up to 5,000fpm (25 m/s). Because the lip is not spring-loaded, its ability to handle misalignment and runout conditions is limited.

Machined Lips — The machined lip allows for tighter control of the lip interference and is used for special applications where the lip load is critical. Both FlexiLip and FlexiCase designs are available with a single machined lip for lubricant retention. Machined lips are also commonly used as an excluder lip in conjunction with a primary formed lip. The machined lip normally has a narrower contact footprint on the shaft so it is more sensitive to eccentricity and runout than the formed lip.

Elf Toe Lips — The elf toe lip profile has a sharp angle on the leading edge of the lip to help keep abrasive media from getting trapped under the lip. The pocket that is formed by this profile also allows a garter spring to be added. The addition of a garter spring allows the lip to maintain contact with the shaft under high misalignment conditions up to 0.020" (0.5 mm) Total Indicator Runout (TIR).

Chamfered Lips — The most common spring-energized lip shape is the chamfered or back-beveled design and is available with the V and C Series spring types. This design allows for ease of installation and permits lubrication to nest under the lip and feed through in reciprocating dynamic applications. The result is a microscopic film of lubrication that increases seal and hardware service life. Since the footprint of a chamfered lip is a single point, all of the sealing force is concentrated, yielding the highest sealability and lowest friction. The high lip contact force limits the use in rotary service to 1000 sfpm (5 m/s).

Scraper Lips — Applications often involve medias with abrasive particles that can get caught between the seal lip and the mating hardware. This increases wear to both the seal and the mating surface. The scraper lip contact point is positioned directly over the load point of the spring in each design for maximum scraping action. The scraper lip can be positioned on the ID, OD or both. The high spring-loaded contact point limits the use in rotary service to low speed applications.

03/28/06

Shaft Considerations

The shaft finish required for PTFE seals is just as critical as that for elastomeric lip seals (see **Page 2-6**).

Proper surface finish is critical to ensure positive sealing, and achieve the longest seal life possible in rotating applications. Rotating surfaces that are too rough can create leak paths and can be very abrasive to the seal. Unlike elastomer contact seals, PTFE-based Flexi designs can run on very smooth surfaces with or without lubrication. Due to the toughness and low coefficient of friction of PTFE, Flexi designs, unlike seals made of other materials, slip over the high points of the mating surface and resist abrasion. To maximize seal performance, the recommendations for surface roughness in **Table 2-5** should be followed.

Dynamic surfaces with relatively rough finishes will result in higher wear rates, which decrease the seal life and may compromise performance. Additionally, dynamic surfaces which have a finish smoother than recommended may also decrease the seal's effectiveness. The optimum surface roughness allows a film of the fluid being sealed to flow between the seal and the mating surface, which effectively lubricates and extends the life of the seal.

PTFE rotary seal applications require a hard running surface on the dynamic portion of the hardware. The harder surface allows the use of higher reinforced seal materials that will increase the seal and hardware life. Softer running surfaces must use lower wear resistant materials that will not damage the hardware and normally yield shorter seal life. A balance between seal material and dynamic surface hardness must be met to ensure that the seal remains the sacrificial component. **Table 9-3** includes minimum recommended surface hardness for Parker materials in dynamic applications, based on temperature, motion and speed.

When the dynamic surface hardness is below 45 Rc, most seal materials will polish the running surface of the hardware and the seal. This initial break-in period will cause seal wear to taper off over a period of time, depending on the seal material, surface finish and PV of the application. When hardness exceeds 45 Rc, the initial surface finish is very important since the surface is much harder to polish and the time to achieve break-in is much longer. Surface hardness above 65 Rc will generally not polish and therefore the initial surface finish is even more critical to seal life. The hardness of the dynamic hardware surface affects the wear rate of the seal. Additionally, some seal lip materials are abrasive and will wear softer metal shafts or dynamic components. In general, higher surface finish results in better overall seal and hardware performance. The ideal hardness of the dynamic surfaces of the hardware is 50 to 60 Rockwell C. The actual hardness used is normally a balance between the additional cost associated with finishing harder materials versus the maximum seal life that will be achievable.

Table 2-5. Surface Roughness, R_a

Media Being Sealed	Dynamic Surfaces		Static Surfaces	
	μ inch	μ m	μ inch	μ m
Cryogenics	4 max.	0.1 max.	8 max.	0.2 max.
Helium Gas Hydrogen Gas Freon	6 max.	0.15 max.	12 max.	0.3 max.
Air Nitrogen Gas Argon Natural Gas Fuel (Aircraft and Automotive)	8 max.	0.2 max.	16 max.	0.4 max.
Water Hydraulic Oil Crude Oil Sealants	12 max.	0.3 max.	32 max.	0.8 max.

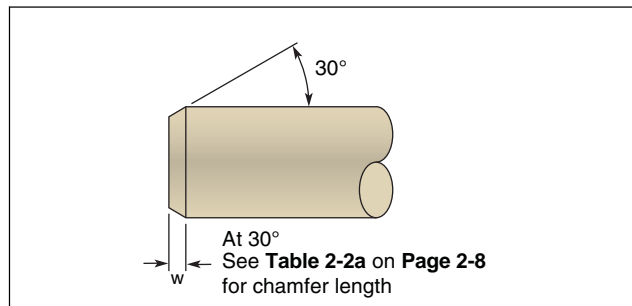
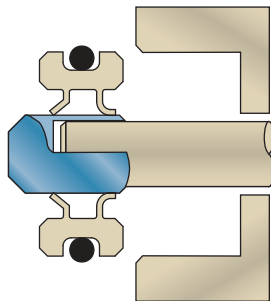

Figure 2-18. Shaft Profile

03/28/06

The leading edge of the shaft should have a burr-free chamfer to ease installation by preventing lip roll-back. Because PTFE lip seals are not as flexible as rubber lip seals they tend to be more difficult to install over the shaft. First time installers of PTFE lip seals normally destroy a few seals before realizing they are more difficult to start over the shaft than a rubber lip seal. When possible, use an installation sleeve to get the PTFE seal started over the shaft. The sleeve will also protect the lips from sharp edges common with keyways or splines.



Installation with Sleeve

Housing/Bore Considerations

Typical FlexiLip and FlexiCase shaft seals are pressed into the bore to assure proper OD sealing and seal retention in the housing. The most commonly used materials for seal housings are steel and cast iron. Care must be taken when softer materials such as aluminum, bronze or plastics are used for the housing material. Aluminum has a thermal expansion rate almost double that of steel. Metal case designs can lose the required press fit in an aluminum housing when they go through thermal cycles due to the higher rate of thermal expansion of aluminum.

A finish range of 32 to 63 $\mu\text{in Ra}$ (1.0 to 2.5 $\mu\text{m Ra}$) is recommended for service pressures up to 3 psi (0.20 bar). If the fluid is thick, such as a grease, a 125 $\mu\text{in Ra}$ (3.17 $\mu\text{m Ra}$) finish would be acceptable with no system pressure.

A lead-in chamfer is highly recommended for all seal housings. The chamfer aligns the seal during installation and helps prevent the seal from cocking. Both corners of the chamfer should be free of burrs and sharp edges.

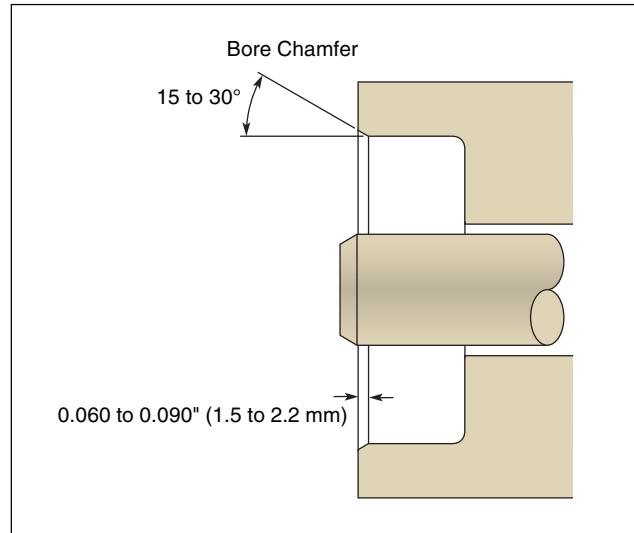
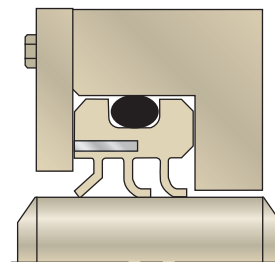
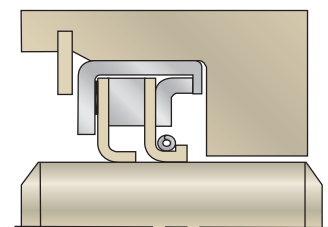

Figure 2-19. Housing Profile

For pressurized rotary applications, additional precautions are needed to ensure the seal is not pushed out of the housing. If the seal is installed in an open bore, a snap ring or cover plate should be added to retain the seal. The specific pressure that requires additional retention is a function of the seal surface area, seal design, internal pressure and bore finish. As a general rule, retention devices should be used with FlexiLip designs in applications over 2 psi (0.15 bar) and FlexiCase designs over 30 psi (2 bar).



FlexiLip in Gland



FlexiCase in Gland

FlexiSeal flanged designs can be used in either static, rotary or reciprocating applications and are designed to be dynamic only on the ID. They excel in rotary applications because the flange can be clamped axially to prevent the seal from rotating with the shaft. This extra stability allows the flanged design to hold more pressure at higher surface speeds. The housing must be made in two pieces for installation purposes and the seal can be installed either lips-first or heel-first.

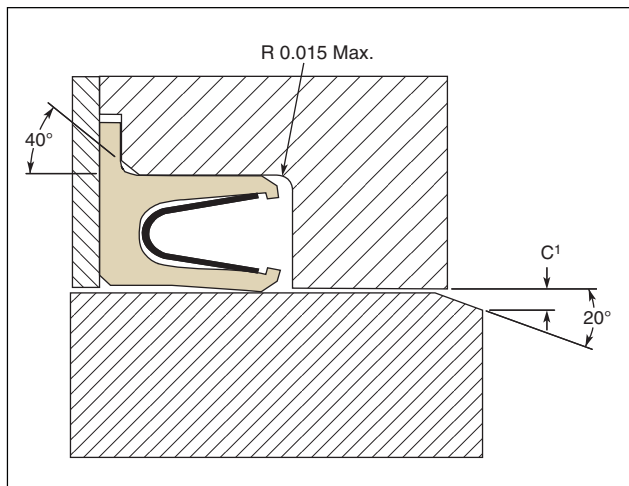
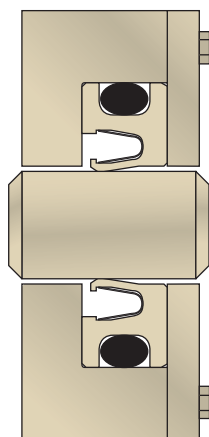

Figure 2-20. Two-Piece Flanged Gland

Since FlexiSeal types FC and FH are primarily used in pressure applications, they too should be used with a retainer plate.



FCC-V in Two-Piece Gland

Pressure and Shaft Velocity

Unlike reciprocating applications, seals that ride on a rotating shaft have a contact point that is localized in only one small area where dynamic forces and energy are concentrated. In fact, much of the energy from the shaft is dissipated at the seal in the form of frictional heat and wear, both of which are detrimental to seal life. This effect is accentuated by increasing the shaft speed or by increasing the perpendicular force holding the lip against the shaft. Shaft speed can be measured in surface feet per minute and the lip force can be approximated by measuring the differential pressure across the seal in psi. Shaft velocity in surface feet per minute is calculated as follows:

$$\text{Surface Velocity (in sfp)} = \frac{\text{Shaft Diameter (inches)}}{\text{Shaft RPM}} \times 0.262$$

One way to estimate the exposure to these risks is to calculate the PV-value by multiplying the pressure held by the seal (P in psi) by the surface velocity of the shaft (V in surface feet per minute). The product of this multiplication provides the designer with a guide to aid in the choice of seal profile and material. Let us run through an example:

Given:
 Pressure = 45 psi
 Shaft diameter = 1.25"
 Shaft rotational speed = 350 RPM

$$\begin{aligned} \text{Surface Velocity} &= \frac{\text{Shaft Diameter}}{\text{Shaft Rotational Speed}} \times 0.262 \\ &= \frac{1.25''}{350 \text{ RPM}} \times 0.262 \\ &= 115 \text{ sfp} \end{aligned}$$

$$\begin{aligned} \text{PV-value} &= \text{Pressure} \times \text{Surface Velocity} \\ &= 45 \text{ psi} \times 115 \text{ sfp} \\ &= 5175 \text{ ft. lb./in}^2 \text{ min.} \end{aligned}$$

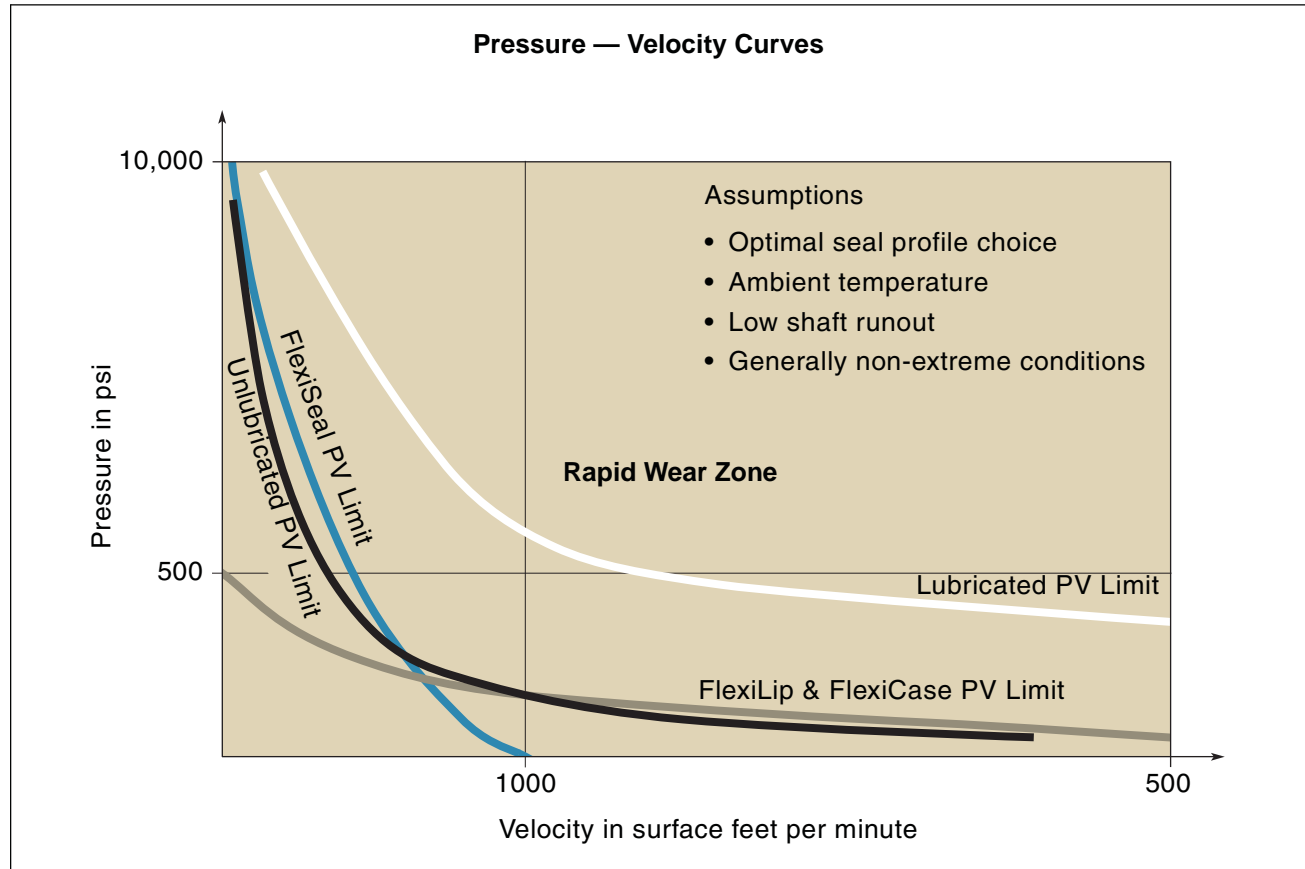

Figure 2-21. Pressure — Velocity Chart

The PV graph in **Figure 2-21** applies to unlubricated rotary applications using a stable rotary seal in a jacket material with a 4 or 5 wear resistance rating. As a rule of thumb, a PTFE rotary seal can be used in unlubricated applications with a PV of up to 150,000.

This information is intended to be used only as a guide since there are many other factors, such as sealing media, hardware material and surface finish, which affect the amount of heat generated and the wear life of the seal. In cases where the media being sealed is a lubricant, these seals can operate continuously at PV levels 10 to 20 times higher than those shown in **Figure 2-21**.

Lubrication

While Parker PTFE seals have a natural lubricity and can be used in unlubricated applications, it is always better to have lubrication present in rotary applications. A film of lubricant

between the seal lip and the shaft reduces seal wear and frictional heat generation, makes higher surface speeds possible, and helps prevent the seal from wearing a groove in the shaft. When the lubricant splashes or flows past the seal area, it acts as a coolant, prolonging seal life.

Rotary PTFE Product Choice

While the black and white curves above attempt to draw the line between what can and cannot be done, they do not show which profiles work best within the limits of feasibility. The blue and brown curves above show which product lines work better with regard to pressure and surface speed assuming there is no lubrication. Rotary FlexiSeals can be used when pressures are high and speeds are low, while FlexiLip and FlexiCase profiles lend themselves more to applications with high surface speeds and low pressure.

03/28/06

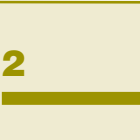

Shaft Misalignment and Runout

Applications with rotating shafts come with their own set of common problems. Among these are those associated with the shaft not being aligned properly with the surrounding hardware. Misalignment most commonly manifests itself as Eccentricity and Runout. Every shaft has some degree of both as described in **Figure 2-22**.

Eccentricity of a rotating shaft creates two problems. One is that it forces the seal lip to follow a shaft that is not centered in the bore, wearing the lip more on one side. Because they are less elastic, PTFE seals are more susceptible to failure, misalignment and runout conditions than elastomeric lip seals. The second potential problem is that it enlarges the extrusion gap on one side, which could be detrimental if high pressure is involved. Extended heel designs will reduce seal extrusion.

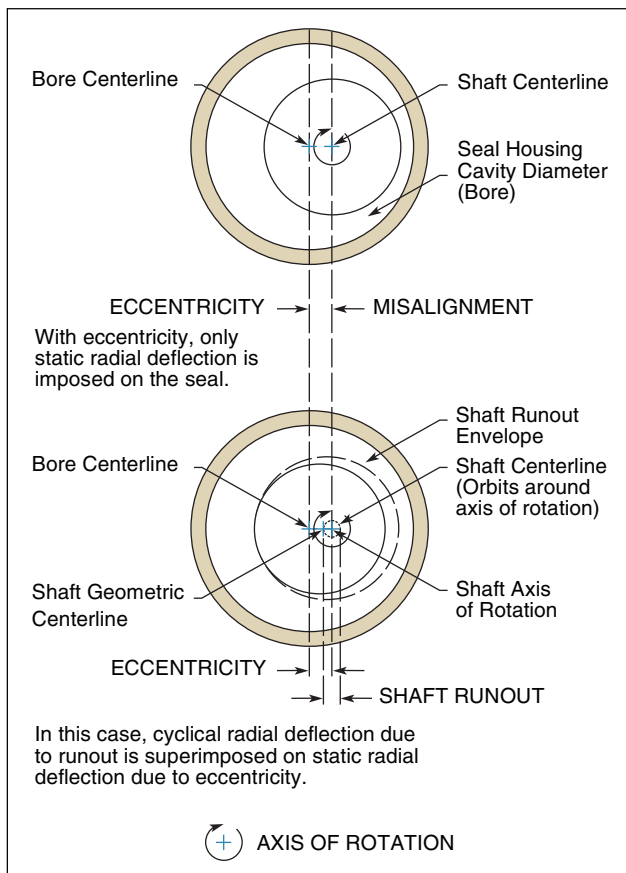

Figure 2-22. Eccentricity and Shaft Runout

Shaft Runout is when the shaft is spinning on an axis of rotation that is offset from the geometric center of the shaft at the point of seal lip contact. Runout can be caused by a bent shaft or by whirling deflection while spinning. The seal must be sufficiently compliant to maintain contact with the shaft despite being compressed and extended each revolution. It follows that shaft runout becomes more of a problem at high speeds.

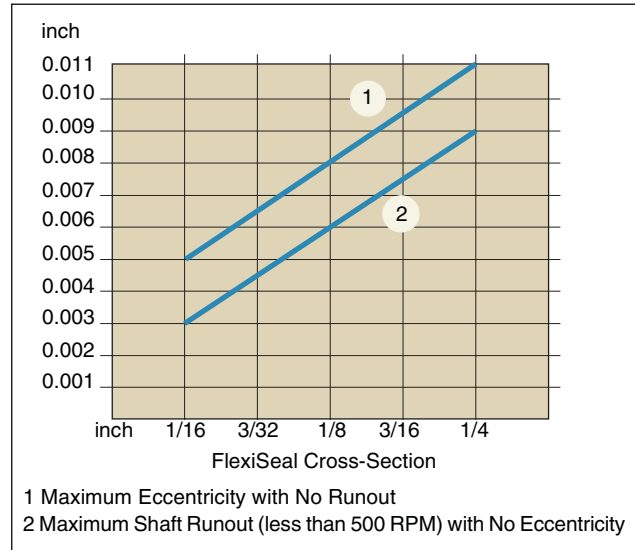

Figure 2-23. FlexiSeal Eccentricity and Runout Limits

All rotating shafts have eccentricity and runout to some degree. The risk of failure increases significantly if a system has a considerable amount of both. **Figure 2-23** shows the acceptable maximum for these parameters for all rotary FlexiSeal profiles except the FFN-H. **Figure 2-24** shows the limits for FlexiLip and FlexiCase profiles.

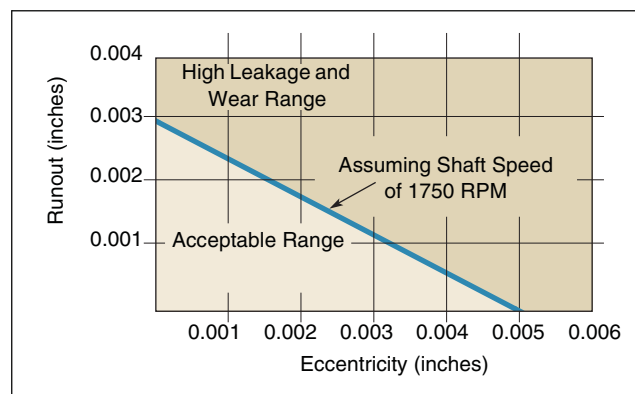

Figure 2-24. FlexiLip and FlexiCase Eccentricity and Runout Limits

03/28/06

Rotary PTFE Seal Considerations

For all rotary seals — FlexiSeal Rotary, FlexiLip and FlexiCase — the designer must consider:

- pressure and shaft velocity
- lubrication
- shaft misalignment and runout
- shaft hardness and surface finish
- advantages of different lip shapes
- shaft lead
- temperature

For additional information on reciprocating applications, please refer to publication EPS 5340, *PTFE Lip Seal Design Guide*.

Alternate Housing Configurations

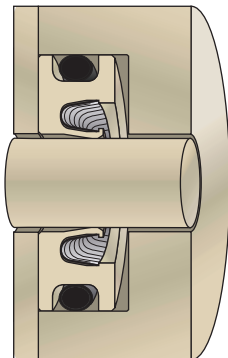

Rotary Housing

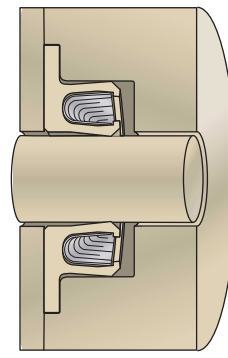

Flanged Rotary Housing

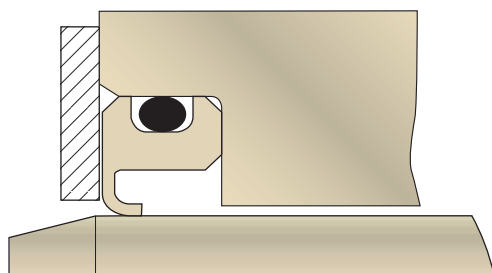

FlexiLip with Retainer for Higher Pressure

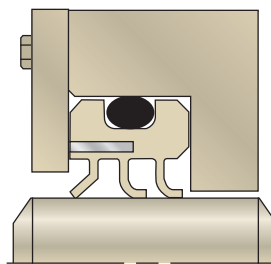

Banded FlexiLip with Retainer

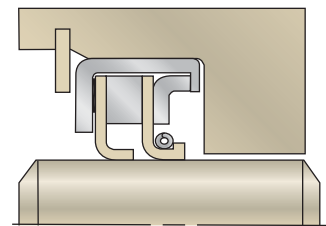

FlexiCase with Snap Ring

03/28/06

Bearing Isolators

General Theory of Operation

Engineered labyrinth type seals, also called “Bearing Isolators,” should be considered when increasing the Mean Time Between Failures (MTBF) is a primary objective for seal selection. Common equipment that uses labyrinth-type seals includes ANSI pumps, IEEE 841 rated electric motors, split pillow block bearings, turbines and gearboxes.

All bearing isolator designs consist of at least a rotor and a stator. An external O-ring at the stator OD maintains a press fit in the seal housing and provides a static seal for oil retention. The O-ring press fit allows for easy seal installation while also providing excellent bore retention. The press fit will withstand external forces to eliminate movement or spinning in the housing and has even been tested in the vertical down position to ensure the stator will not walk out of the seal bore.

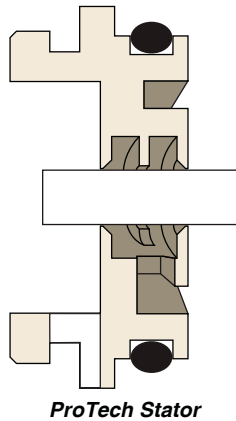

ProTech Stator

The stator has a series of internal grooves to retain oil splash and return it to the sump. Before ProTech® seal designs were introduced, bearing isolators relied on a single inboard groove for oil retention.

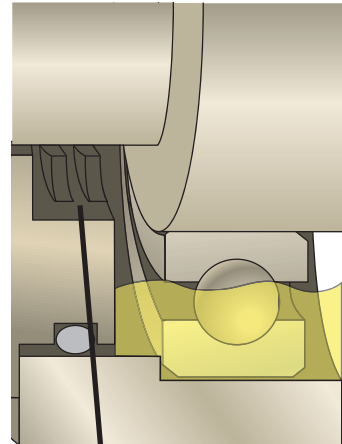

Double Groove

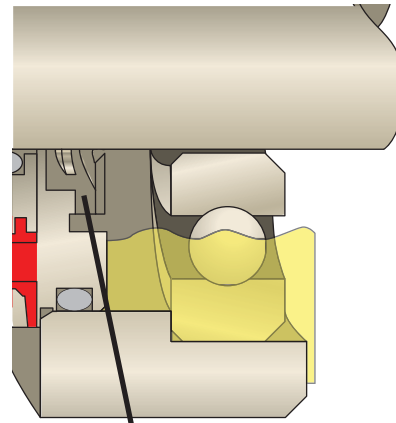

Severe Splash Groove

To improve lubricant retention capability, Parker offers a double groove and a severe splash design. The double groove design works well for grease and mild oil splash. Parker developed and introduced the severe splash design for applications where oil splash is heavy. The severe splash design is also used in applications where outboard mounted fans are present and are pulling the lubricant through a simple groove design. Types “LS”, “LN” and “LB” feature a double groove. A severe oil splash groove is standard on types “LW”, “LX”, “ML” and “MN”.

An outboard drain port is machined in the stator. Contaminants that enter the assembled seal are expelled through this drain port. During installation it is imperative that the drain port is centered at the 6 o'clock position. Designs with multiple drain ports are available for applications when equipment mounting in the field cannot ensure the drain port will be positioned at 6 o'clock.

03/28/06

2

The second component, the rotor, uses an external static O-ring at the seal ID to maintain a press fit on the shaft. Since the rotor spins with the shaft, it will not wear, groove or cause damage, so the costs associated with having to recondition the sealing surface are eliminated.

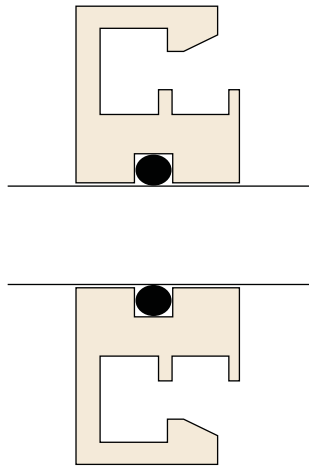

ProTech Rotor

The wraparound profile of the ProTech rotor is no accident. Years of testing allowed Parker to refine this feature to provide optimal water exclusion. As a result of Parker's testing and design leadership, the wraparound rotor profile is quickly becoming an industry standard.

The rotor and stator are assembled at the factory where they are permanently unitized by means of patented processes. Unitized, two-piece designs were pioneered and patented by Parker. Unitized designs allow for one-piece installation and maintain a minimal clearance between the rotor and stator interface for the life of the seal. This interface is the first line of defense against contamination. A unitized design maintains the seal's integrity by keeping high-pressure water spray, vibration or axial movement from separating or increasing the gap between the rotor and stator.

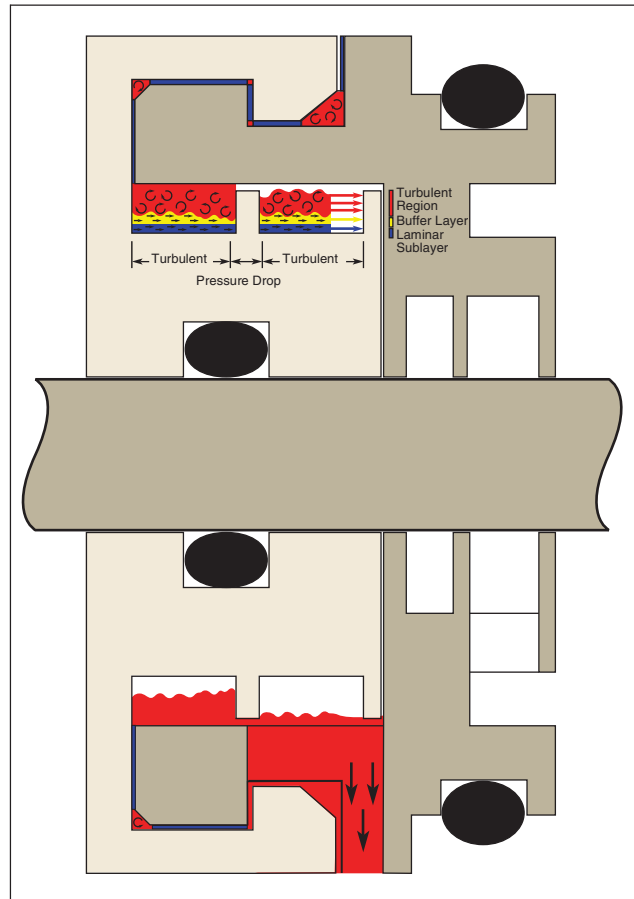
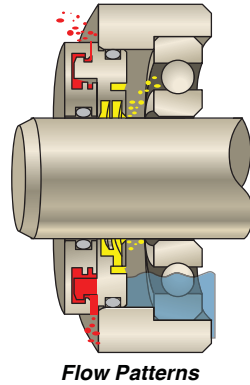

Figure 2-25. Pressure Drops and Turbulence

Bearing isolators are very effective at retaining grease or oil splash. Except for hybrid designs such as the ProTech 360, they are not designed to be used in "flooded" oil applications. A flooded condition occurs when the oil level is above the seal's oil drain-back port during operation. Prior to installing a labyrinth-type seal, it is important to verify that the cavity between the seal and the bearing does not become flooded during operation.

03/28/06

Excessive oil pumping by the bearing, inadequate oil drain back design of the housing or excessive oil levels are the most common causes of unexpected flooded conditions. For oil lubrication, bearing isolators are designed for oil levels that are filled to the center of the bottom roller of the bearing.



ProTech Bearing Isolators excel in their ability to exclude contaminants such as dust, water and even high-pressure water spray. Because they are non-contact, the seals provide superior exclusion for the life of the bearing. They provide such a long service life because they do not form a dynamic seal at the shaft like traditional lip seals do. As an additional benefit, maintaining the optimal shaft finish is not required when using labyrinth seals.

ProTech designs are available that exceed ingress protection levels according to IEEE IP55, IP56, IP66 and IP69k. For additional information on IEEE levels of protection, see **Table 8-2**.

Across the industry, bearing isolators are available in a wide range of designs. Some use internal seals such as O-rings, locking rings, lip seals or other components as a primary seal and to lock the seal components together.

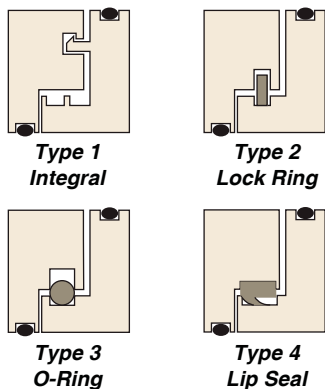

High performance designs like Parker ProTech rely on true, non-contact labyrinth technology (Type 1). The performance of true non-contact designs is more reliable over time because there are no internal components to wear out or become clogged by contamination. As a rule of thumb, avoid designs that rely on internal components for sealability or unitizing the rotor and stator (Types 2, 3 and 4). The presence of internal components is an indication that the labyrinth design may be inferior. The performance of such designs are reduced to zero when tested with the internal component removed. Consequently, as the internal seal wears, performance will decrease. Internal components that serve as the primary seal are often affected by temperature, centrifugal force and chemicals with unintended and undesirable results.

Bearing isolators are available in a wide range of materials including high performance PTFE, bronze, carbon steel, stainless steel and various other alloys. The primary considerations for material selection are chemical resistance, temperature and internal dusting. PTFE is the preferred material because it has the best chemical resistance, lowest friction and best balance of properties of any of the materials used.

Internal dusting is a common trait of bearing isolators. During initial break in, dusting of the seal material will occur. As the seal dust can enter the bearing cavity, a material that will not damage the bearing (such as PTFE) should be selected when possible.

Housing bore requirements regarding finish are the same as standard lip seals with dimensional tolerances of $\pm .002''$ ($\pm .05$ mm). Lead-in chamfers are also recommended to prevent damage during installation.

Because bearing isolators do not create a dynamic seal at the shaft, shaft finish is not as important as that required for a lip seal. Typical shaft finishes are 16 to 32 μ n Ra (0.4 to 0.8 μ m Ra) but up to 60 μ n Ra (1.5 μ m Ra) is acceptable.

Parker's numerous standard designs allow for retrofits without any equipment modifications for most applications. Custom designs are also readily available. For additional information on bearing isolators, refer to **Section 8** of this catalog.

03/28/06

Testing and Validation

2

Finite Element Analysis (FEA) allows new concepts to be studied for weaknesses and compared to potential modifications before tooling and samples are made. Bench testing equipment meeting SAE J110 standards is used to verify design capabilities.

Utilizing sophisticated test equipment, Parker technicians accurately perform tests, controlling conditions such as shaft speed, temperature, misalignment, pressure and chemical compatibility. Tests evaluate fluid containment as well as water and contaminant exclusion. Custom fixtures are designed and built for unique situations, incorporating customer's equipment to evaluate the entire sealing system of a specific application. When necessary, independent testing laboratories are used to verify results.

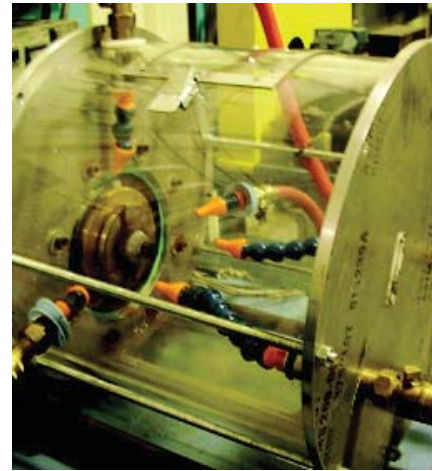

Water Exclusion Test Chamber



Vertical Up Test Unit



IP X6 Water Exclusion Testing

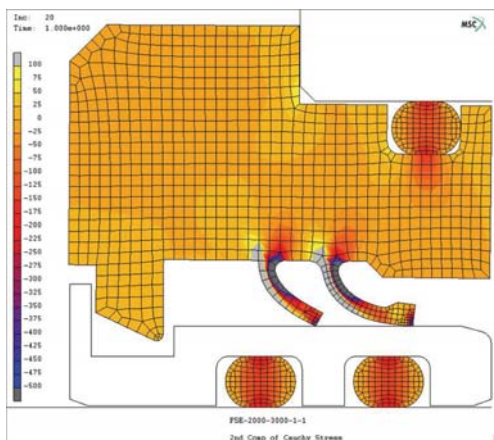

FEA Capability

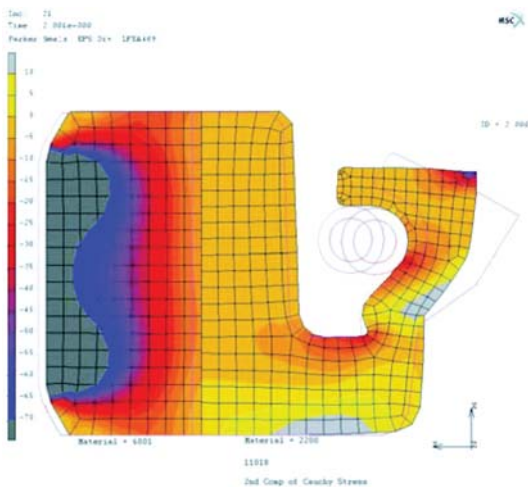

03/28/06

Materials Excellence

Parker chemists work with leading polymer scientists using the latest advances in formulating new materials for challenging applications and making improvements to existing compounds. They work hand in hand with manufacturing and review each batch of material for quality assurance before it is released for production. Standard procedures are written and followed, ensuring that the highest possible batch-to-batch consistency is maintained.



Lip Materials

Nitrile (NBR)

Standard Nitrile is the most commonly used polymer in the rotary shaft seal industry. NBR has very good resistance to oil, fuel and alkali solutions. Nitrile offers excellent resistance to petroleum-based hydraulic fluids and is resistant to hydrocarbon solvents. Standard Nitrile has poor resistance to ozone, ketones, automotive or aircraft brake fluid, and steam or hot water. Standard Nitrile is recommended for operating temperatures ranging from -20 to +250 °F (-29 to +121 °C) and offers good mechanical properties and abrasion resistance.

Low Temp Nitrile (NBR)

Nitrile compounds can be formulated for applications in extreme cold weather environments. These special formulations of Nitrile allow for operation at minimum temperatures ranging down to -70 °F (-57 °C), while maintaining good chemical and abrasion resistance, but the upper temperature limit is lowered to 212 °F (100 °C).

Carboxylated Nitrile (XNBR)

XNBR is formulated to greatly enhance tear and abrasion resistance over standard Nitrile, while maintaining similar chemical compatibility. It is used in applications where abrasive particles may collect at the point of shaft contact. XNBR is less resilient and flexible at low temperature, and offers poorer compression set resistance than standard Nitrile. Carboxylated Nitriles are recommended for operation at temperatures ranging from -30 to +250 °F (-34 to +121°C).

Hydrogenated Nitrile (HNBR)

Hydrogenated Nitriles offer improved abrasion resistance, excellent chemical resistance and higher operating temperatures than standard NBR. Ozone and weather resistance, as well as resistance to hot water are also increased. HNBR compounds are recommended for operating temperatures ranging from -40 to +300 °F (-40 to +149 °C).

Fluoroelastomer (FKM)

FKM provides excellent resistance to oils, fuels and hydraulic fluids at temperatures that far exceed standard Nitrile. It also has very good resistance to flame and excellent impermeability to gases and vapors. FKM is recommended for operating temperatures that range from -40 to +400 °F (-40 to +204 °C).

PTFE (T)

Polytetrafluoroethylene is recommended for use with virtually any fluid. Extremely low friction, wide temperature range and dry running capabilities are other advantages of PTFE materials. Excellent mechanical properties are achieved when PTFE is blended with fillers such as glass, bronze, carbon fiber, graphite, mineral and others. Parker EPS has over 300 compounds to cover virtually all application requirements. Parker can bond PTFE to rubber for enhanced performance.

Ethylene Propylene (EPDM)

EPDM offers excellent heat, ozone and sunlight resistance. EPDM has very good low temperature flexibility, good resistance to alkalis, acids (such as acetic), and oxygenated solvents (such as MEK). Provides improved resistance to water and steam in applications where NBR and FKM exhibit poor service life. Good replacement for FKM where solvents are a problem. It is not recommended for petroleum oil. EPDM is recommended for operating temperatures of -60 to +300 °F (-51 to +149°C).

Polyacrylate (ACM)

Polyacrylate elastomers are most often recommended for higher operating temperatures or applications where extreme pressure (EP) lubricants are used. This material also offers additional resistance over standard Nitrile to ozone and weather attack. Recommended for operating temperatures ranging between -15 to +300 °F (-26 to +149 °C).

Silicone (VMQ)

Generally recommended for high temperature, low friction applications. Silicone is resistant to weather, ozone, water, bases and alcohols. Not recommended in applications where steam, acids, aliphatic hydrocarbons, aromatic hydrocarbons, halogenated hydrocarbons, phosphate ester or polar solvents are present. It has poor abrasion resistance. Recommended for operating temperatures ranging from -90 to +400 °F (-67 to +204 °C).

03/28/06

Neoprene (CR)

Neoprene offers very good resistance to weather, ozone and natural aging as well as good flame resistance while maintaining moderate resistance to oil and gasoline. Good abrasion, flex and cracking resistance is available with the Neoprene material. Neoprene is recommended for operating temperatures ranging from -45 to +250 °F (-43 to +121 °C).

3**Case Materials****Neoprene/Aramid Composite**

The aramid fiber-reinforced composite shell will fit a wide range of bore tolerances and provides a rustproof gasket type seal at the OD. The composite case also will fill slight imperfections in the bore housing, reducing machining cost. Usually combined with a Nitrile lip material.

Fluoroelastomer/Aramid Composite

Offers the same construction benefits mentioned above. Usually combined with a Fluoroelastomer lip material.

Metal Case

Cold rolled carbon steel is the most common and cost-effective metal case material. The cases are treated to resist corrosion during normal handling and storage. Stainless steel case materials are available at additional costs for use in corrosive applications and extreme conditions. ParKote™, a polymer coating, is standard on Parker Oil Seals. Polymer coatings are optional on other metal case designs. This coating helps fill small imperfections in the bore. A ground OD is also available. Other case materials include stainless steel, aluminum, zinc-plated cold rolled steel and Hastelloy®.





Rubber Covered



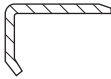

Case material can be partially or completely coated in rubber. Generally, carbon steel cases are used in rubber molded options. Rubber covered OD offers improved bore sealing.

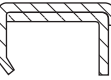
03/28/06

Materials

Table 3-1. Case Profiles/Materials

Application	Description	Profile
Most common and economical. ParKote™ coating is standard.	"L" Case	B 
Improved OD sealing in bores with minor imperfections and in soft alloy housings.	Rubber Covered Case	C 
Inner case provides structural rigidity for large cross-sections. ParKote™ coating is standard. Guides shaft during installation.	Double Case	A 
Rustproof, gasket like OD seal. Ease of installation.	Aramid Fiber Composite Case	H1, H5 

Application	Description	Profile
Ease of removal. Positioning flange.	"P" Case	P 
Protects metal case from internal corrosion.	Rubber Lined Case	M 
Reduced spring back. Ease of installation. Combines sealability of rubber OD and metal retention of metal OD	Heel Case	D 
Rustproof, gasket-like OD seal. Ease of installation. Metal bands for severe shock loads.	Aramid Fiber Composite Case	STH 

Spring Materials

Springs are available in a wide range of materials from Parker. Parker Oil Seal profiles are provided with carbon steel springs as standard. Clipper Oil Seal designs are furnished with 302 stainless steel springs as standard. Standard spring materials for PTFE FlexiSeal profiles are stainless steel, Hastelloy® and Elgiloy®. Other spring materials are available at an additional cost. **Table 3-2** shows general operating parameters for the most common spring materials.

Table 3-2. Spring Material Parameters

Wire Type	Maximum Service Temperature		Application
	°C	°F	
Carbon Steel	120	250	General purpose
Monel 400	230	450	Saltwater
Inconel 750	675	1250	Extreme temperature
Phosphor Bronze	95	200	Saltwater
302/304 Stainless Steel	260	500	Corrosion resistance
316 Stainless Steel	315	600	Hi-temp corrosion resistance
Hastelloy®	204	400	Corrosion resistance
Elgiloy®	260	500	Corrosion resistance

Monel® is a registered trademark of Inco Alloys International, Inc.
Inconel® is a registered trademark of Huntington Alloys Corporation.

Product Offering

Catalog EPS 5350/USA

Product Line

Clipper® Oil Seal

- Single Lip LUP, RUP
- Double Lip LDS
- Large Diameter MIST, STLUP
- Medium Pressure MP
- High Pressure HP
- Clipper Split Seal
- Custom Designs
- Wipers H & P
- High Misalignment LUPW, LDSW
- PTFE Bonded to Elastomer Lip

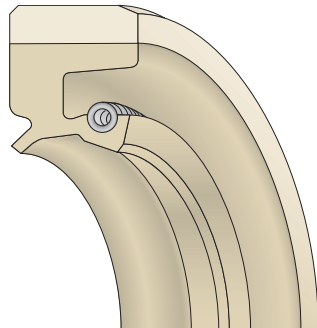

Clipper Oil Seal

Parker Oil Seal

- Single Lip Seals SA, SB, SC, SD, SM
- Double Lip TA, TB, TC, TD, TM
- Dual Lip DB, DC
- Springless VA, VB, VC, VM
- Outside Lip OSA, OSB, OSC
- Cassette Seals
- Wipers
- High Misalignment SAE, SCE, SME
- Custom Designs

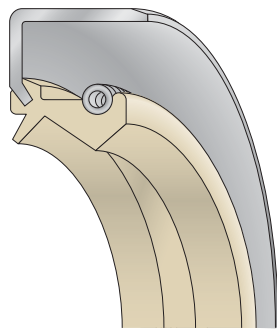

Parker Oil Seal

Shaft Repair Sleeves

- Quick Sleeve (0.010" wall)
- Wear Sleeves (0.125" wall)

Bearing Isolators

ProTech™ PTFE

- Flanged LS
- Non-flanged LN
- Vertical UP LW, LX
- Split SL
- Pillow Block LM
- Flooded FS-360
- Custom Designs

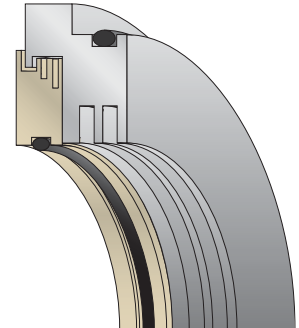

ProTech Bearing Isolator

ProTech Millennium Bronze

- Flanged ML
- Non-flanged MN
- Split MS
- Custom Designs

PTFE Seals

- FlexiCase™ Metal Clad & TMAL
- Metal w/o Spring TMAS
- Nonmetallic w/o Spring FlexiLip™
- Custom Designs
- 3 A Sanitary
- Food Grade
- Anti-Microbial

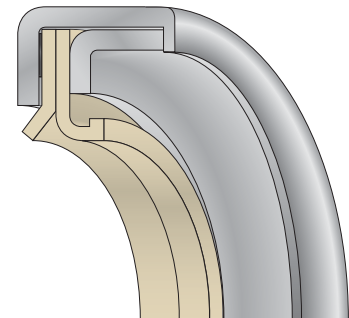

FlexiCase Rotary Seal

Slings & Excluders

- V-Seals
- SSW Excluder
- DS Excluder

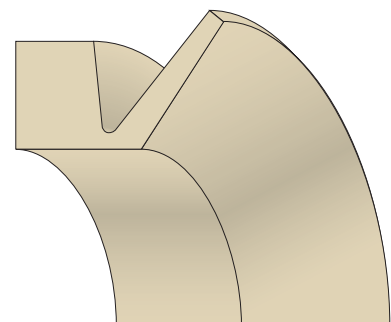

V-Seal











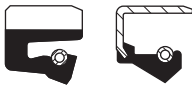









03/28/06



Profiles

Table 4-1. Product Profiles











Standard Profiles	Other Profiles Available	Features	Applications
Clipper and Parker Oil Seals			
LUP SB 	SC SA SM SD 	General purpose. Spring-loaded single lip. For oil retention or grease retention.	Electric motors, gearboxes, pumps, fans, runout tables, paper rolls, mixers and custom equipment.
RUP RPD 		Spring-loaded, single lip design. Available split or solid. Splits — for grease retention — with oil, some seepage may occur. Positive bore retention. NO COVER PLATE REQUIRED.	Electric motors, gearboxes, pumps, fans, runout tables, paper rolls, mixers and custom equipment. Split seals are designed for applications where equipment is unable to be disassembled due to time constraints.
LUPW LPDW 		Spring-loaded single lip. Features nonmetallic composite OD for damage-free installation.	High runout conditions for applications up to 1" (25.4 mm) total eccentricity. For oil retention and low speeds.
LDS TB 	TC TA TM TD 	General purpose. Spring-loaded dual lip. For oil retention. Excludes light dust and fluid.	Electric motors, gearboxes, pumps, fans, runout tables, paper rolls, mixers and custom equipment.
LDSW SCE 	SAE SME 	Spring-loaded, single or double lip.	High runout conditions up to 0.125" (3.175 mm) total eccentricity. For oil or grease retention and low speeds. Typical applications: electric motors, gearboxes, pumps, fans, runout tables, paper rolls, mixers and custom equipment.
SDS KB 	KC KA KM 	General purpose. Dual lip springless design.	For grease retention and exclusion of light dust and fluids. Typical light duty applications.
SS VB 	VC VA VM 	General purpose. Springless single lip.	For grease retention and exclusion of light dust and fluid. Typical light duty applications.
OL OSB 	OSC OSA 	Outside lip design. Spring-loaded single lip. For rotating bores.	For applications where the bore rotates. Generally used in grease applications.
MIST 	STMIST STMIST w/Buttons 	Single lip w/molded-in spring. Eliminates spring dumping. Available with metal bands for severe shock loads. Spacer buttons available.	For heavy duty applications. Work rolls, paper rolls, runout tables and custom equipment.
STLUP 	STLUP w/Buttons 	Spring-loaded single lip. Metal bands for severe shock loads. Spacer buttons available.	For heavy duty applications. Work rolls, paper rolls, runout tables and custom equipment.

4

Operating Temperature Range	Shaft Surface Speed fpm (m/s)	Shaft Size Range Inches (mm)	Maximum Shaft Dynamic Runout (TIR)	Maximum (STBM) Misalignment	Maximum Pressure psi (bar)	Page
NBR -20 °F to 250 °F -29 °C to 121 °C FKM -40 °F to 400 °F -40 °C to 204 °C	Up to 3200 (16.3)	1/4 – 62.5 (5 – 1587)	0.010" (0.254 mm)	0.010" (0.254 mm)	0 – 7 (0 – 0.48) <i>Depending on Shaft Speed</i>	5-14, 6-12
NBR -20 °F to 250 °F -29 °C to 121 °C FKM -40 °F to 400 °F -40 °C to 204 °C	Up to 2000 (10.2)	1/2 – 65 (13 – 1651)	0.010" (0.254 mm)	0.010" (0.254 mm)	0 – 3 (0 – 0.20) <i>Depending on Shaft Speed</i>	5-27
NBR -20 °F to 250 °F -29 °C to 121 °C FKM -40 °F to 400 °F -40 °C to 204 °C	Up to 1000 (5.1) <i>Speed Depends on Runout</i>	1 – 50 (41 – 1270)	0.020 – 1.125" (0.508 – 28.58 mm)	0.020 – 1.125" (0.508 – 28.58 mm)	0 – 7 (0 – 0.48) <i>Depending on Shaft Speed</i>	5-15
NBR -20 °F to 250 °F -29 °C to 121 °C FKM -40 °F to 400 °F -40 °C to 204 °C	Up to 2500 (12.7)	3/4 – 25 (19 – 635)	0.010" (0.254 mm)	0.010" (0.254 mm)	0 – 7 (0 – 0.48) <i>Depending on Shaft Speed</i>	5-14, 6-12
NBR -20 °F to 250 °F -29 °C to 121 °C FKM -40 °F to 400 °F -40 °C to 204 °C	Up to 2500 (12.7) <i>Speed Depends on Runout</i>	3/4 – 25 (19 – 635)	0.020 – 0.125" (0.508 – 3.175 mm)	0.010 – 0.125" (0.508 – 3.175 mm)	0 – 3 (0 – 0.20) <i>Depending on Shaft Speed</i>	5-15, 6-17
NBR -20 °F to 250 °F -29 °C to 121 °C FKM -40 °F to 400 °F -40 °C to 204 °C	Up to 2000 (10.2)	1/2 – 12.835 (12.7 – 326)	0.010" (0.254 mm)	0.010" (0.254 mm)	0 – 7 (0 – 0.48) <i>Depending on Shaft Speed</i>	5-23, 6-13
NBR -20 °F to 250 °F -29 °C to 121 °C FKM -40 °F to 400 °F -40 °C to 204 °C	Up to 2000 (10.2)	1/4 – 6 (6.4 – 152)	0.010" (0.254 mm)	0.010" (0.254 mm)	0 – 7 (0 – 0.48) <i>Depending on Shaft Speed</i>	5-23, 6-13
NBR -20 °F to 250 °F -29 °C to 121 °C FKM -40 °F to 400 °F -40 °C to 204 °C	Up to 1000 (5.1)	1 – 65 (25 – 1651)	0.010" (0.254 mm)	0.010" (0.254 mm)	0 – 7 (0 – 0.48) <i>Depending on Shaft Speed</i>	5-17, 6-18
NBR -20 °F to 250 °F -29 °C to 121 °C FKM -40 °F to 400 °F -40 °C to 204 °C	Up to 3200 (16.3)	6 – 48 (152 – 1219)	0.010" (0.254 mm)	0.010" (0.254 mm)	0 – 7 (0 – 0.48) <i>Depending on Shaft Speed</i>	5-26
NBR -20 °F to 250 °F -29 °C to 121 °C FKM -40 °F to 400 °F -40 °C to 204 °C	Up to 3200 (16.3)	5 – 57.875 (127 – 1470)	0.010" (0.254 mm)	0.010" (0.254 mm)	0 – 7 (0 – 0.48) <i>Depending on Shaft Speed</i>	5-18

03/28/06

Table 4-1. Product Profiles (Continued)

Standard Profiles	Other Profiles Available	Features	Applications
Clipper and Parker Oil Seals (Continued)			
LifeLine 		Single lip w/molded-in spring. Eliminates spring dumping. Molded-in steel reinforcing bar. All rubber construction. For shock installations. Spacer buttons available.	For heavy duty applications. Work rolls, paper rolls, runout tables and custom equipment.
P 		Shallow cavity rod wiper for reciprocating service. Designed to exclude dust and contamination.	Applications for reciprocating service and low speed.
H 	W 	General purpose rod wiper. For rotary and reciprocating service. Springless single lip. For dust exclusion.	Applications for rotary and reciprocating service.
DS 		DS is designed for internal deflection of heavy oil splash or external exclusion of dust or spray. The design is pressed fit onto the shaft. DS is known as a deflector seal.	Used internally on gearboxes or other industrial equipment with internal splash.
SSW 		SSW is designed for applications for external washdowns or severe dusty environments. The seal rides against the face of the housing to keep contamination from the primary seals.	Electric motors, mining or washdown applications.
HP 		High pressure with a fluoro-elastomer sealing element, outer metal case, and a PTFE backup element for pressure. Standard with carbon steel case. Stainless steel and other alloys available.	The High Pressure (HP) seal is designed to handle rotary and reciprocating motions at high speeds and temperatures. Typical applications: pumps, compressors and custom equipment.
MP 	TDN3 SEC NTC 	Medium Pressure (MP) seal. MP seals come with FKM material for high temperatures normally associated with friction caused by pressure.	Pumps, washers and compressors.
DB 	DC 	Dual spring-loaded lips.	Used to separate two fluids.

4













Operating Temperature Range	Shaft Surface Speed fpm (m/s)	Shaft Size Range Inches (mm)	Maximum Shaft Dynamic Runout (TIR)	Maximum (STBM) Misalignment	Maximum Pressure psi (bar)	Page
NBR -20 °F to 250 °F -29 °C to 121 °C FKM -40 °F to 400 °F -40 °C to 204 °C	Up to 3200 (16.3)	6 – 48 (152 – 1219)	0.010" (0.254 mm)	0.010" (0.254 mm)	0 – 7 (0 – 0.48) <i>Depending on Shaft Speed</i>	5-26
NBR -20 °F to 250 °F -29 °C to 121 °C FKM -40 °F to 400 °F -40 °C to 204 °C	Reciprocating: Up to 300 (1.5)	3/8 – 30 (10 – 762)	N/A	0.008" (0.20 mm)	0	5-22
NBR -20 °F to 250 °F -29 °C to 121 °C FKM -40 °F to 400 °F -40 °C to 204 °C	Rotary: Up to 2000 (10.2) Reciprocating: Up to 300 (1.5)	3/8 – 30 (10 – 762)	N/A	0.008" (0.20 mm)	0	5-22, 6-20
NBR -20 °F to 250 °F -29 °C to 121 °C FKM -40 °F to 400 °F -40 °C to 204 °C	Up to 2500 (12.7)	3/4 – 15 (19 – 381)	N/A	N/A	0	12-9
NBR -20 °F to 250 °F -29 °C to 121 °C FKM -40 °F to 400 °F -40 °C to 204 °C	Up to 2500 (12.7)	1 – 25 (25 – 635)	N/A	N/A	0	12-9
NBR -20 °F to 250 °F -29 °C to 121 °C FKM -40 °F to 400 °F -40 °C to 204 °C	Up to 4000 (20.3)	1/4 – 8 (6.4 – 203)	0.003" (0.076 mm)	0.003" (0.076 mm)	300 (20)	5-16
NBR -20 °F to 250 °F -29 °C to 121 °C FKM -40 °F to 400 °F -40 °C to 204 °C	Up to 4000 (20.3)	1/4 – 12.500 (6.4 – 317)	0.005" (0.127 mm)	0.005" (0.127 mm)	100 (7)	5-16, 6-15
NBR -20 °F to 250 °F -29 °C to 121 °C FKM -40 °F to 400 °F -40 °C to 204 °C	Up to 2000 (10.2)	1/4 – 4 (6.4 – 101)	0.010" (0.254 mm)	0.010" (0.254 mm)	0 – 7 (0 – 0.48) <i>Depending on Shaft Speed</i>	6-14



03/28/06



Table 4-1. Product Profiles (Continued)

Standard Profiles	Other Profiles Available	Features	Applications
Clipper and Parker Oil Seals (Continued)			
Clipper Sliptite 	SBF SCF TBF TCF 	The Clipper Sliptite is a specially designed seal that utilizes a layer of PTFE bonded to the sealing lip to reduce excessive wearing on the shaft and seal.	With the PTFE lip the seal can be utilized in dry running applications, at higher speeds, and accepts a broader range of chemical compatibility. Typical applications: electric motors, gearboxes, pumps, fans and custom equipment.
TMAL 	TMAS 	The stainless steel outer case contains a machined PTFE element with and without a spring to activate the lip.	TMAL & TMAS seals are designed for corrosive chemical service and FDA application.
TN 		The TN seal comes with a single lip element that combines the low friction properties of PTFE with the flexibility and durability of rubber. The seal comes with an outer metal case.	The TN seal was specially developed for severe service applications.
CB 	CL (Low Speed) CH (High Speed) 	Unitized seal offered with a rubber covered or metal OD. Sealing elements ride on a proper internal sealing surface which offers the advantage of eliminating the cost of preparing or resurfacing the shaft for a lip seal and makes seal replacement easier.	Gearboxes, reducers, agricultural equipment and pumps.
RPDT 		General purpose spring-loaded single lip seal. Available in splits only.	Typical applications: steel mills, pillow blocks.
TSS 		Features nonmetallic composite OD for damage-free installation. Provides a soft flexible lip which provides low friction sealing contact to give extended service life.	Typical applications: overhead cranes in steel mills, rotary drilling crown and travel blocks, draglines, hoist and elevators. Also used on mine cart wheels, flywheels and idler wheels.
Shaft Sleeves			
Quick Sleeve 		Ultra thin, 0.010" (0.25 mm), hard chrome plated stainless steel shaft repair sleeve.	Grooved or unfinished shafts.
WS — Wear Sleeve, Non-flanged 	WS — Wear Sleeve, Flanged 	Carbon sleeve phosphate coated or ground finish.	Grooved or unfinished shafts.

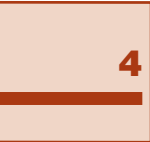

Operating Temperature Range	Shaft Surface Speed fpm (m/s)	Shaft Size Range Inches (mm)	Maximum Shaft Dynamic Runout (TIR)	Maximum (STBM) Misalignment	Maximum Pressure psi (bar)	Page
NBR -20 °F to 250 °F -29 °C to 121 °C FKM -40 °F to 400 °F -40 °C to 204 °C	Up to 5000 (25.4)	1/2 – 10 (12.7 – 254)	0.010" (0.254 mm)	0.010" (0.254 mm)	0 – 7 (0 – 0.48) <i>Depending on Shaft Speed</i>	5-24, 6-19
PTFE - 40 °F to 500 °F -40 °C to 260 °C	Up to 2500 (12.7)	1/2 – 14 (10 – 350)	0.006" (0.152 mm)	0.006" (0.152 mm)	0 – 7 (0 – 0.48) <i>Depending on Shaft Speed</i>	5-25
PTFE - 40 °F to 500 °F -40 °C to 260 °C	Up to 2500 (12.7)	3/8 – 6 (9.5 – 152)	0.006" (0.152 mm)	0.010" (0.254 mm)	10 (0.69)	6-19
NBR -20 °F to 250 °F -29 °C to 121 °C FKM -40 °F to 400 °F -40 °C to 204 °C	Up to 3200 (16.3)	1/2 – 14 (10 – 350)	0.010" (0.254 mm)	0.010" (0.254 mm)	0 – 7 (0 – 0.48) <i>Depending on Shaft Speed</i>	6-16
NBR -20 °F to 250 °F -29 °C to 121 °C FKM -40 °F to 400 °F -40 °C to 204 °C	Up to 2000 (10.2)	3.375 – 16 (85.73 – 406)	0.010" (0.254 mm)	0.010" (0.254 mm)	0	5-21
NBR -20 °F to 250 °F -29 °C to 121 °C FKM -40 °F to 400 °F -40 °C to 204 °C	Up to 2000 (10.2)	1.274 – 17.500 (32.36 – 445)	0.010" (0.254 mm)	0.010" (0.254 mm)	0	5-19
N/A	N/A	N/A	N/A	N/A	N/A	7-1
N/A	N/A	N/A	N/A	N/A	N/A	7-1



03/28/06

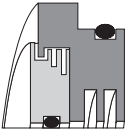
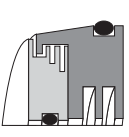
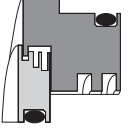
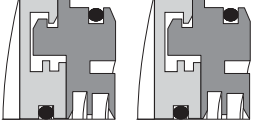
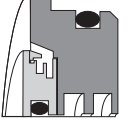
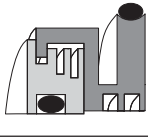
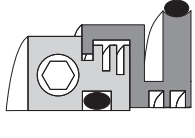

Table 4-1. Product Profiles (Continued)

Standard Profiles	Features	Applications
ProTech Bearing Isolators		
<p>LSE, LSM</p> 	<p>Flanged — General purpose sealing in flanged designs. PTFE material. Excludes heavy water spray and dry contaminants from the bearing cavity. Retains grease and oil splash (oil level must be below inboard oil drain-back or non-flooded).</p>	<p>Electric motors, pumps, mixers, gear boxes, blowers and custom equipment.</p>
<p>LNE, LNM</p> 	<p>Non-flanged — Specifically designed for flush mount applications. General purpose sealing in non-flanged design. PTFE material. Excludes heavy water spray and dry contaminants from the bearing cavity. Retains grease and oil splash (oil level must be below inboard oil drain-back or non-flooded).</p>	<p>Electric motors, pumps, mixers, gear boxes, blowers and custom equipment.</p>
<p>LME, LMM</p> 	<p>Step Shaft — Specifically designed to accommodate step shaft application. Flanged designs. PTFE material. Excludes heavy water spray and dry contaminants from the bearing cavity. Retains grease and oil splash (oil level must be below inboard oil drain-back or non-flooded).</p>	<p>Electric motors, pumps, mixers, gear boxes, blowers and custom equipment.</p>
<p>LWE, LWM, LXE, LXM</p> 	<p>Wrap Around — Specifically designed for heavier water spray exclusion. Vertical up optional design is “LX,” same as “LW” but with no drain port. PTFE material. Excludes heavy water spray and dry contaminants from the bearing cavity. Retains grease and oil splash (oil level must be below inboard oil drain-back or non-flooded).</p>	<p>Electric motors, pumps, mixers, gear boxes, blowers and custom equipment. LX is without drain port for vertical up applications.</p>
<p>LDE, LDM</p> 	<p>Multi Port — For use in applications where drain port cannot be fixed at six o'clock position. PTFE material. Excludes heavy water spray and dry contaminants from the bearing cavity. Retains grease and oil splash (oil level must be below inboard oil drain-back or non-flooded).</p>	<p>Electric motors, pumps, mixers, gear boxes, blowers and custom equipment.</p>
<p>LBE, LBM</p> 	<p>Pillow Block — Solid seal design for sealing split pillow block bearings. PTFE material. Excludes heavy water spray and dry contaminants from the bearing cavity. Retains grease and oil splash (oil level must be below inboard oil drain-back or non-flooded).</p>	<p>Drop in replacement for LER ring. Easily interchanged by LER number and shaft diameter.</p>
<p>SB</p> 	<p>Pillow Block — Split seal design for sealing split pillow block bearings. PTFE material. Excludes heavy water spray and dry contaminants from the bearing cavity. Retains grease and oil splash (oil level must be below inboard oil drain-back or non-flooded).</p>	<p>Drop in replacement for LER ring for split pillow block bearings. Easily interchanged by LER number and shaft diameter.</p>

4

Operating Temperature Range	Shaft Surface Speed fpm (m/s)	Shaft Size Range Inches (mm)	Maximum Shaft Dynamic Runout (TIR)	Maximum (STBM) Misalignment	Maximum Pressure psi (bar)	Page
-40 °F to 250 °F -40 °C to 121 °C	Up to 5,000 (25.4)	Standards: 1/2 – 10 (12.7 – 254) Specials: to 20 (508)	0.020" (0.51 mm)	± 0.020" (± 0.51 mm) <i>Special Designs Available</i>	0	8-22
-40 °F to 250 °F -40 °C to 121 °C	Up to 5,000 (25.4)	Standards: 1/2 – 10 (12.7 – 254) Specials: to 20 (508)	0.020" (0.51 mm)	± 0.020" (± 0.51 mm) <i>Special Designs Available</i>	0	8-23
-40 °F to 250 °F -40 °C to 121 °C	Up to 5,000 (25.4)	Standards: 1/2 – 10 (12.7 – 254) Specials: to 20 (508)	0.020" (0.51 mm)	± 0.020" (± 0.51 mm) <i>Special Designs Available</i>	0	See note below.
-40 °F to 250 °F -40 °C to 121 °C	Up to 3,000 (15.2)	Standards: 1/2 – 10 (12.7 – 254) Specials: to 20 (508)	0.020" (0.51 mm)	± 0.020" (± 0.51 mm) <i>Special Designs Available</i>	0	8-25
-40 °F to 250 °F -40 °C to 121 °C	Up to 5,000 (25.4)	Standards: 1/2 – 10 (12.7 – 254) Specials: to 20 (508)	0.020" (0.51 mm)	± 0.020" (± 0.51 mm) <i>Special Designs Available</i>	0	See note below.
-40 °F to 250 °F -40 °C to 121 °C	Up to 5,000 (25.4)	Standards: 1/2 – 10 (12.7 – 254) Specials: to 20 (508)	0.020" (0.51 mm)	± 0.020" (± 0.51 mm) <i>Special Designs Available</i>	0	8-24
-40 °F to 250 °F -40 °C to 121 °C	Up to 5,000 (25.4)	Standards: 1/2 – 10 (12.7 – 254) Specials: to 20 (508)	0.020" (0.51 mm)	± 0.020" (± 0.51 mm) <i>Special Designs Available</i>	0	8-24





Note: LM Series: Call engineering for step shaft applications.
 LD Series: Call engineering for multi-port applications.

03/28/06

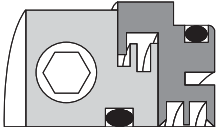

Table 4-1. Product Profiles (Continued)

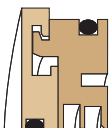
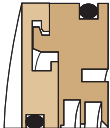
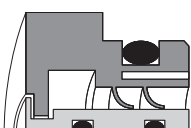
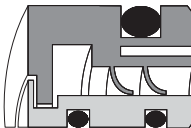
Standard Profiles	Features	Applications
ProTech Bearing Isolators (Continued)		
<p>SLE, SLM</p> 	<p>Split — Split design for field retrofits where equipment can not be uncoupled or disassembled. Requires no wear sleeves or shaft refurbishment. PTFE material. Excludes heavy water spray and dry contaminants from the bearing cavity. Retains grease and oil splash (oil level must be below inboard oil drain-back or non-flooded).</p>	<p>Electric motors, pumps, mixers, gear boxes, blowers and custom equipment.</p>
<p>WDE, WDM</p> 	<p>Wash Down — Wash down purpose in narrow flanged designs. PTFE material. Specifically designed to exclude high pressure water spray and dry contaminants in limited space applications. For grease retention.</p>	<p>Small disposable electric motors and equipment for food processing industry. Economical for 140 & 480 frame IEEE 841 electric motors.</p>
<p>MLE, MLM</p> 	<p>Flanged Millennium — Specifically designed for heavier water spray exclusion. Bronze material. Also excludes dry contaminants from the bearing cavity. Retains grease and oil splash (oil level must be below inboard oil drain-back or non-flooded).</p>	<p>Electric motors, pumps, mixers, gear boxes, blowers and custom equipment.</p>
<p>MNE, MNM</p> 	<p>Non-flanged Millennium — Specifically designed for flush mount applications. General purpose sealing in non-flanged design. Bronze material. Excludes heavy water spray and dry contaminants from the bearing cavity. Retains grease and oil splash (oil level must be below inboard oil drain-back or non-flooded).</p>	<p>Electric motors, pumps, mixers, gear boxes, blowers and custom equipment.</p>
<p>FSE, FSM</p> 	<p>Flanged 360 — Specifically designed for oil flooded and oil mist applications. Maximum 5 psi (0.3 bar) internal pressure. PTFE material with stainless steel rotor. Excludes heavy water spray and dry contaminants from the bearing cavity.</p>	<p>Electric motors, pumps, mixers, gear boxes, blowers, cooling towers, aerators and custom equipment. Oil mist lubrication systems.</p>
<p>FNE, FNM</p> 	<p>Non-flanged 360 — Specifically designed for oil flooded and oil mist applications where seal must be flush mounted. Maximum 5 psi (0.3 bar) internal pressure. PTFE material with stainless steel rotor. Excludes heavy water spray and dry contaminants from the bearing cavity.</p>	<p>Electric motors, pumps, mixers, gear boxes, blowers, cooling towers, aerators and custom equipment. Oil mist lubrication systems.</p>

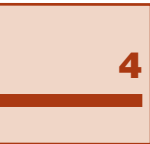



Operating Temperature Range	Shaft Surface Speed fpm (m/s)	Shaft Size Range Inches (mm)	Maximum Shaft Dynamic Runout (TIR)	Maximum (STBM) Misalignment	Maximum Pressure psi (bar)	Page
-40 °F to 250 °F -40 °C to 121 °C	Up to 3,000 (15.2) <i>Contact Factory for Speeds Over 3,000 (15.2)</i>	1/2 – 10 (12.7 – 254) Specials: to 38 (965)	0.020" (0.51 mm)	± 0.020" (± 0.51 mm) <i>Special Designs Available</i>	0	8-27
-40 °F to 250 °F -40 °C to 121 °C	Up to 3,000 (15.2) <i>Contact Factory for Speeds Over 3,000 (15.2)</i>	0.492 – 5 (12.5 – 130)	0.020" (0.51 mm)	± 0.020" (± 0.51 mm) <i>Special Designs Available</i>	0	8-26
-40 °F to 400 °F -40 °C to 204 °C	Up to 7,000 (35.6) SM Design: 3,000 (15.2)	0.610 – 6 (15.5 – 152)	0.010" (0.25 mm)	± 0.010" (± 0.25 mm) <i>Special Designs Available</i>	0	8-29
-40 °F to 400 °F -40 °C to 204 °C	Up to 7,000 (35.6) SM Design: 3,000 (15.2)	0.610 – 6 (15.5 – 152)	0.010" (0.25 mm)	± 0.010" (± 0.25 mm) <i>Special Designs Available</i>	0	8-30
-40 °F to 250 °F -40 °C to 121 °C	Up to 5,000 (25.4) <i>Contact Factory for Speeds Over 3,000 (15.2)</i>	1/2 – 10 (12.7 – 254)	0.003" (0.08 mm)	± 0.005" (± 0.13 mm) <i>Special Designs Available</i>	5 (0.3)	8-31
-40 °F to 250 °F -40 °C to 121 °C	Up to 5,000 (25.4) <i>Contact Factory for Speeds Over 3,000 (15.2)</i>	1/2 – 10 (12.7 – 254)	0.003" (0.08 mm)	± 0.005" (± 0.13 mm) <i>Special Designs Available</i>	5 (0.3)	8-32



03/28/06

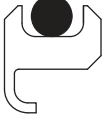
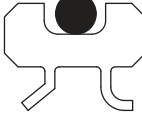
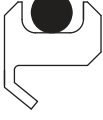
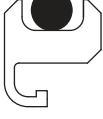
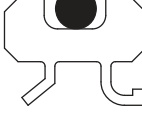
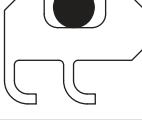

Table 4-1. Product Profiles (Continued)

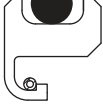
Standard Profiles	Features	Applications
FlexiLip Seals		
LFN-N 	Formed Primary Lip	Multipurpose Seal
LFE-N 	Formed Primary Lip w/ Excluder Lip	Multipurpose Seal
LMN-N 	Machined Primary Lip	Low Friction
LEN-N 	Elf-Toe Primary Lip	Abrasive Media
LEE-N 	Elf-Toe Primary Lip w/ Excluder Lip	Abrasive Media
LDN-N 	Dual Primary Lips	Oil Seal — Flooded, Severe Splash
LDE-N 	Dual Primary Lips w/ Excluder Lip	Oil Seal — Flooded, Severe Splash
LGN-N 	Primary Lip Energized with Garter Spring	Slow, high runout applications up to 0.020" (0.51 mm) TIR

4



Operating Temperature Range	Shaft Surface Speed fpm (m/s)	Shaft Size Range Inches (mm)	Maximum Shaft Dynamic Runout (TIR)	Maximum (STBM) Misalignment	Maximum Pressure psi (bar)	Page
0 °F to 250 °F (-18 °C to 120 °C)	5000 (25.4)	Min 0.625 (16) Max 12 (305)	.003 (.07)	.005 (.12)	60 (4.14)	9-1
0 °F to 250 °F (-18 °C to 120 °C)	5000 (25.4)	Min 0.750 (19) Max 12 (305)	.003 (.07)	.005 (.12)	60 (4.14)	9-1
0 °F to 250 °F (-18 °C to 120 °C)	6000 (30.5)	Min 0.750 (19) Max 12 (305)	.003 (.07)	.005 (.12)	30 (2.07)	9-1
0 °F to 250 °F (-18 °C to 120 °C)	5000 (25.4)	Min 0.750 (19) Max 12 (305)	.004 (.101)	.005 (.12)	60 (4.14)	9-1
0 °F to 250 °F (-18 °C to 120 °C)	5000 (25.4)	Min 0.750 (19) Max 12 (305)	.004 (.101)	.005 (.12)	60 (4.14)	9-1
0 °F to 250 °F (-18 °C to 120 °C)	5000 (25.4)	Min 0.750 (19) Max 12 (305)	.003 (.07)	.005 (.12)	150 (10.35)	9-1
0 °F to 250 °F (-18 °C to 120 °C)	5000 (25.4)	Min 0.750 (19) Max 12 (305)	.003 (.07)	.005 (.12)	150 (10.35)	9-1
0 °F to 250 °F (-18 °C to 120 °C)	2000 (10.2)	Min 0.750 (19) Max 12 (305)	.020 (.508) Max based on shaft speed < 100 sfpm (0.5 m/s)	.010 (.25)	60 (4.14)	9-1



03/28/06

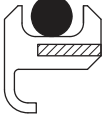
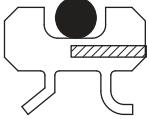
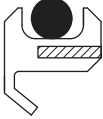

Table 4-1. Product Profiles (Continued)

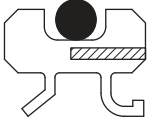
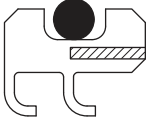
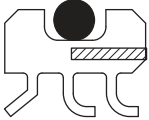
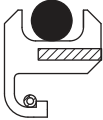
Standard Profiles	Features	Applications
FlexiLip Seals (Continued)		
LFN-S 	Formed Primary Lip w/ Metal Band	Wide temperature ranges or shafts over 4" (100 mm).
LFE-S 	Formed Primary Lip w/ Excluder Lip w/ Metal Band	Wide temperature ranges or shafts over 4" (100 mm).
LMN-S 	Machined Primary Lip w/ Metal Band	Low Friction Wide temperature ranges or shafts over 4" (100 mm).
LEN-S 	Elf-Toe Primary Lip w/ Metal Band	Abrasive Media Wide temperature ranges or shafts over 4" (100 mm).
LEE-S 	Elf-Toe Primary Lip w/ Excluder Lip w/ Metal Band	Abrasive Media Wide temperature ranges or shafts over 4" (100 mm).
LDN-S 	Dual Primary Lips w/ Metal Band	Oil Seal — Flooded, Severe Splash Wide temperature ranges or shafts over 4" (100 mm).
LDE-S 	Dual Primary Lips w/ Excluder Lip w/ Metal Band	Oil Seal — Flooded, Severe Splash Wide temperature ranges or shafts over 4" (100 mm).
LGN-S 	Primary Lip Energized with Garter Spring w/ Metal Band	Slow speed, high runout applications up to 0.020" (0.5 mm) TIR. Wide temperature ranges or shafts over 4" (100 mm).

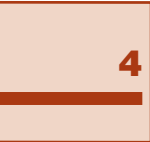

03/28/06



Operating Temperature Range*	Shaft Surface Speed fpm (m/s)	Shaft Size Range Inches (mm)	Maximum Shaft Dynamic Runout (TIR)	Maximum (STBM) Misalignment	Maximum Pressure psi (bar)	Page
Limited by O-ring material. See chart on Page 8-17.	5000 (25.4)	Min 0.625 (16) Max 12 (305)	.003 (.07)	.005 (.12)	60 (4.14)	9-1
Limited by O-ring material. See chart on Page 8-17.	5000 (25.4)	Min 0.750 (19) Max 12 (305)	.003 (.07)	.005 (.12)	60 (4.14)	9-1
Limited by O-ring material. See chart on Page 8-17.	6000 (30.5)	Min 0.750 (19) Max 12 (305)	.003 (.07)	.005 (.12)	30 (2.07)	9-1
Limited by O-ring material. See chart on Page 8-17.	5000 (25.4)	Min 0.750 (19) Max 12 (305)	.004 (.101)	.005 (.12)	60 (4.14)	9-1
Limited by O-ring material. See chart on Page 8-17.	5000 (25.4)	Min 0.750 (19) Max 12 (305)	.004 (.101)	.005 (.12)	60 (4.14)	9-1
Limited by O-ring material. See chart on Page 8-17.	5000 (25.4)	Min 0.750 (19) Max 12 (305)	.003 (.07)	.005 (.12)	150 (10.35)	9-1
Limited by O-ring material. See chart on Page 8-17.	5000 (25.4)	Min 0.750 (19) Max 12 (305)	.003 (.07)	.005 (.12)	150 (10.35)	9-1
Limited by O-ring material. See chart on Page 8-17.	2000 (10.2)	Min 0.750 (19) Max 12 (305)	.020 (.508) Max for shaft speeds < 100 sfpm (0.5 m/s)	.010 (.25)	60 (4.14)	9-1



03/28/06

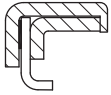
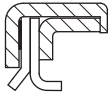
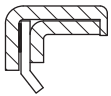
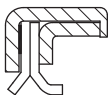
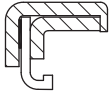
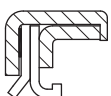

Table 4-1. Product Profiles (Continued)

Standard Profiles	Features	Applications
FlexiCase Seals		
CFN 	Formed Primary Lip	General purpose rotary shaft seal.
CFE 	Formed Primary Lip w/ Excluder Lip	Ideal to keep oil in and water & dirt out.
CMN 	Machined Primary Lip	General purpose rotary shaft seal w/ low breakaway torque.
CME 	Machined Primary Lip w/Excluder Lip	Ideal to keep oil in and water & dirt out. Low Breakaway torque.
CEN 	Elf-Toe Primary Lip	General purpose rotary shaft seal where shaft runout is 0.005 to 0.010" (0.13 to 0.25 mm) or abrasive media.
CEE 	Elf-Toe Primary Lip w/ Excluder Lip	Ideal to keep oil in and water & dirt out where shaft runout is 0.005 to 0.010" (0.13 to 0.25 mm) or abrasive media.
CDN 	Dual Primary Lips	Redundant sealing for aircraft or other low leakage systems.
CDE 	Dual Primary Lips w/ Excluder Lip	Redundant sealing for aircraft or other low leakage systems. Keeps water & dirt out.

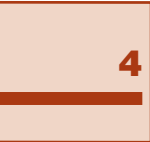

03/03/06









Operating Temperature Range*	Shaft Surface Speed fpm (m/s)	Shaft Size Range Inches (mm)	Maximum Shaft Dynamic Runout (TIR)	Maximum (STBM) Misalignment	Maximum Pressure psi (bar)	Page
Limited by gasket material. Use O-ring chart on Page 8-17.	5000 (25.4)	Min 0.125 (3) Max 6 (152)	0.003 (0.07)	0.005 (0.12)	250 (17.25)	10-1
Limited by gasket material. Use O-ring chart on Page 8-17.	5000 (25.4)	Min 0.250 (6.4) Max 6 (152)	0.003 (0.07)	0.005 (0.12)	125 (8.63)	10-1
Limited by gasket material. Use O-ring chart on Page 8-17.	6000 (30.5)	Min 0.250 (6.4) Max 6 (152)	0.003 (0.07)	0.005 (0.12)	125 (8.63)	10-1
Limited by gasket material. Use O-ring chart on Page 8-17.	6000 (30.5)	Min 0.250 (6.4) Max 6 (152)	0.003 (0.07)	0.005 (0.12)	125 (8.63)	10-1
Limited by gasket material. Use O-ring chart on Page 8-17.	5000 (25.4)	Min 0.125 (3) Max 6 (152)	0.004 (0.101)	0.005 (0.12)	250 (17.25)	10-1
Limited by gasket material. Use O-ring chart on Page 8-17.	5000 (25.4)	Min 0.250 (6.4) Max 6 (152)	0.004 (0.101)	0.005 (0.12)	125 (8.63)	10-1
Limited by gasket material. Use O-ring chart on Page 8-17.	5000 (25.4)	Min 0.250 (6.4) Max 6 (152)	0.003 (0.07)	0.005 (0.12)	250 (17.25)	10-1
Limited by gasket material. Use O-ring chart on Page 8-17.	5000 (25.4)	Min 0.250 (6.4) Max 6 (152)	0.003 (0.07)	0.005 (0.12)	250 (17.25)	10-1

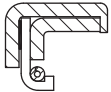

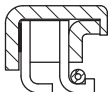
03/28/06



Table 4-1. Product Profiles (Continued)

Standard Profiles	Features	Applications
FlexiCase Seals (Continued)		
CGN 	Primary Lip Energized with Garter Spring	Use when shaft runout is 0.010 to 0.020" (0.25 to 0.51 mm) or abrasive media.
CGE 	Primary Lip Energized with Garter Spring w/ Excluder Lip	Use when shaft runout is 0.010 to 0.020" (0.25 to 0.51 mm) or abrasive media. Keeps water & dirt out.
CJN 	Dual Lip Seal w/ Primary Lip Energized with Garter Spring	Use when redundant sealing is needed & shaft runout is 0.010 to 0.020" (0.25 to 0.51 mm) or abrasive media.
CJE 	Dual Lip Seal w/ Primary Lip Energized with Garter Spring w/ Excluder Lip	Use when redundant sealing is needed & shaft runout is 0.010 to 0.020" (0.25 to 0.51 mm) or abrasive media. Keeps water & dirt out.
CHN 	High Pressure Dual-Lip Seal with Metal Backup Washer	Redundant seal for high pressure aircraft or other low leakage systems.
CHE 	High Pressure Dual-lip Seal with Metal Backup Washer w/ Excluder Lip	Redundant seal for high pressure aircraft or other low leakage systems. Keeps water & dirt out.
FlexiSeal Rotary Seals		
FCC-V 	O-Ring Centered in OD, Chamfered ID, Cantilever Spring	Optimum sealability. Available in 125 cross-section and higher.
FCS-V 	O-Ring Centered in OD, Scraper ID, Cantilever Spring	Minimizes contamination threat. Available in 125 cross-section and higher.
FCC-C 	O-Ring Centered in OD, Chamfered ID, Canted-Coil Spring	Reduced friction and sealability. Available in 125 cross-section and higher.

03/03/06









Operating Temperature Range	Shaft Surface Speed fpm (m/s)	Shaft Size Range Inches (mm)	Maximum Shaft Dynamic Runout (TIR)	Maximum (STBM) Misalignment	Maximum Pressure psi (bar)	Page
Limited by gasket material. Use O-ring chart on Page 8-17 .	2000 (10.2)	Min 0.250 (6.4) Max 6 (152)	0.020 (0.508) Max for shaft speeds < 100 sfpm (0.5 m/s)	0.010 (0.25)	125 (8.63)	10-1
Limited by gasket material. Use O-ring chart on Page 8-17 .	2000 (10.2)	Min 0.250 (6.4) Max 6 (152)	0.020 (0.508) Max for shaft speeds < 100 sfpm (0.5 m/s)	0.010 (0.25)	125 (8.63)	10-1
Limited by gasket material. Use O-ring chart on Page 8-17 .	2000 (10.2)	Min 0.250 (6.4) Max 6 (152)	0.020 (0.508) Max for shaft speeds < 100 sfpm (0.5 m/s)	0.010 (0.25)	125 (8.63)	10-1
Limited by gasket material. Use O-ring chart on Page 8-17 .	2000 (10.2)	Min 0.250 (6.4) Max 6 (152)	0.020 (0.508) Max for shaft speeds < 100 sfpm (0.5 m/s)	0.010 (0.25)	125 (8.63)	10-1
Limited by gasket material. Use O-ring chart on Page 8-17 .	2000 (10.2)	Min 0.250 (6.4) Max 6 (152)	0.003 (0.07)	0.005 (0.12)	500 (3.45)	10-1
Limited by gasket material. Use O-ring chart on Page 8-17 .	2000 (10.2)	Min 0.250 (6.4) Max 6 (152)	0.003 (0.07)	0.005 (0.12)	500 (3.45)	10-1
Limited by O-ring material. See chart on Page 8-17 .	1000 (5.1)	Min 0.125 (3) Max 16 (406)	See Fig. 2-23 on Page 2-25 .	See Fig. 2-23 on Page 2-25 .	3,000 (210)	11-9
Limited by O-ring material. See chart on Page 8-17 .	1000 (5.1)	Min 0.125 (3) Max 16 (406)	See Fig. 2-23 on Page 2-25 .	See Fig. 2-23 on Page 2-25 .	3,000 (210)	11-9
Limited by O-ring material. See chart on Page 8-17 .	1000 (5.1)	Min 0.125 (3) Max 16 (406)	See Fig. 2-23 on Page 2-25 .	See Fig. 2-23 on Page 2-25 .	3,000 (210)	11-9

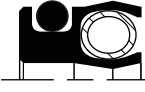

03/28/06



Table 4-1. Product Profiles (Continued)

Standard Profiles	Features	Applications
FlexiSeal Rotary Seals (Continued)		
FCS-C 	O-Ring Centered in OD, Scraper ID, Canted-Coil Spring	Low friction with contamination resistance. Available in 125 cross-section and higher.
FHC-V 	O-Ring in Heel OD, Chamfered ID, Cantilever Spring	Optimum sealability. Available in extended heel option only.
FHS-V 	O-Ring in Heel OD, Scraper ID, Cantilever Spring	Minimizes contamination threat. Available in extended heel option only.
FHC-C 	O-Ring in Heel OD, Chamfered ID, Canted-Coil Spring	Reduced friction and sealability. Available in extended heel option only.
FHS-C 	O-Ring in Heel OD, Scraper ID, Canted-Coil Spring	Low friction with contamination resistance. Available in extended heel option only.
FFC-V 	Flanged Heel OD, Chamfered ID, Cantilever Spring	Optimum sealability. Premium bore retention.
FFS-V 	Flanged Heel OD, Scraper ID, Cantilever Spring	Minimizes contamination threat. Premium bore retention.
FFC-C 	Flanged Heel OD, Chamfered ID, Canted-Coil Spring	Reduced friction and sealability. Premium bore retention.
FFS-C 	Flanged Heel OD, Scraper ID, Canted-Coil Spring	Low friction with contamination resistance. Premium bore retention.

4







Operating Temperature Range	Shaft Surface Speed fpm (m/s)	Shaft Size Range Inches (mm)	Maximum Shaft Dynamic Runout (TIR)	Maximum (STBM) Misalignment	Maximum Pressure psi (bar)	Page
Limited by O-ring material. See chart 8-7 on Page 8-17 .	1000 (5.1)	Min 0.125 (3) Max 6 (152)	See Fig. 2-23 on Page 2-25 .	See Fig. 2-23 on Page 2-25 .	3,000 (210)	11-9
Limited by O-ring material. See chart 8-7 on Page 8-17 .	1000 (5.1)	Min 0.125 (3) Max 16 (406)	See Fig. 2-23 on Page 2-25 .	See Fig. 2-23 on Page 2-25 .	1,000 (70)	11-9
Limited by O-ring material. See chart 8-7 on Page 8-17 .	1000 (5.1)	Min 0.125 (3) Max 16 (406)	See Fig. 2-23 on Page 2-25 .	See Fig. 2-23 on Page 2-25 .	1,000 (70)	11-9
Limited by O-ring material. See chart 8-7 on Page 8-17 .	1000 (5.1)	Min 0.125 (3) Max 16 (406)	See Fig. 2-23 on Page 2-25 .	See Fig. 2-23 on Page 2-25 .	1,000 (70)	11-9
Limited by O-ring material. See chart 8-7 on Page 8-17 .	1000 (5.1)	Min 0.125 (3) Max 16 (406)	See Fig. 2-23 on Page 2-25 .	See Fig. 2-23 on Page 2-25 .	1,000 (70)	11-9
-450 to 600 °F (-268 to 315 °C)	1000 (5.1)	Min 0.125 (3) Max 16 (406)	See Fig. 2-23 on Page 2-25 .	See Fig. 2-23 on Page 2-25 .	3,000 (210)	11-11
-450 to 600 °F (-268 to 315 °C)	1000 (5.1)	Min 0.125 (3) Max 16 (406)	See Fig. 2-23 on Page 2-25 .	See Fig. 2-23 on Page 2-25 .	3,000 (210)	11-11
-450 to 600 °F (-268 to 315 °C)	1000 (5.1)	Min 0.125 (3) Max 16 (406)	See Fig. 2-23 on Page 2-25 .	See Fig. 2-23 on Page 2-25 .	3,000 (210)	11-11
-450 to 600 °F (-268 to 315 °C)	1000 (5.1)	Min 0.125 (3) Max 16 (406)	See Fig. 2-23 on Page 2-25 .	See Fig. 2-23 on Page 2-25 .	3,000 (210)	11-11



03/28/06



Table 4-1. Product Profiles (Continued)

Standard Profiles	Features	Applications
FlexiSeal Rotary Seals (Continued)		
FFN-H 	Flanged Heel OD, Rounded ID, Helical Spring	Static or intermittent rotary only. High sealability and friction.
V-Seals and Excluders		
Style A 	All rubber excluder has stretch fit on shaft. Extended flexible lip seals against counter face.	Small motors, conveyors, appliances, agriculture, automotive, work rolls, rolling mills, pumps and gear boxes.
Style S 	Wide body for higher speed applications	Small motors, conveyors, appliances, agriculture, automotive, work rolls, rolling mills, pumps and gear boxes.
Style L 	Narrow cross-section where space is limited	Small motors, conveyors, appliances, agriculture, automotive, work rolls, rolling mills, pumps and gear boxes, pillow block bearings.
Style E 	Heavy duty design for large diameter applications.	Rolling mills, work rolls, backup rolls.
Style DS 	DS is designed for internal deflection of heavy oil splash or external deflection of dust or spray. The design is press fit onto the shaft. DS is known as a deflector seal.	Used internally on gearboxes or other industrial equipment with internal splash. Also used as external slinger
Style SSW 	SSW is designed for applications for external washdowns or severe dusty environments. The seal rides against the face of the housing to keep contamination from the primary seals.	Electric motors, mining, washdown or roller mill applications.

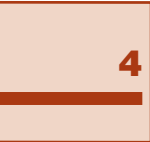

Operating Temperature Range	Shaft Surface Speed fpm (m/s)	Shaft Size Range Inches (mm)	Maximum Shaft Dynamic Runout (TIR)	Maximum (STBM) Misalignment	Maximum Pressure psi (bar)	Page
-450 to 600 °F (-268 to 315 °C)	50 (0.25)	Min 0.500 (12) Max 16 (406)	See Fig. 2-23 on Page 2-25.	See Fig. 2-23 on Page 2-25.	3,000 (210)	11-11
NBR -40 °F to 225 °F (-40 °C to 107 °C) FKM -30 °F to 325 °F (-34 °C to 163 °C)	1600 (8.1)	0.110 – 79.530 (2.79 – 2020)	Within limits of dimension B1. See Appendix E.	1° to 4°	N/A	12-5
NBR -40 °F to 225 °F (-40 °C to 107 °C) FKM -30 °F to 325 °F (-34 °C to 163 °C)	1600 (8.1)	0.180 – 8.270 (4.57 – 210)	Within limits of dimension B1. See Appendix E.	1° to 4°	N/A	12-6
NBR -40 °F to 225 °F (-40 °C to 107 °C) FKM -30 °F to 325 °F (-34 °C to 163 °C)	1600 (8.1)	5.320 – 18.70 (135 – 475)	Within limits of dimension B1. See Appendix E.	1° to 4°	N/A	12-7
NBR -40 °F to 225 °F (-40 °C to 107 °C) FKM -30 °F to 325 °F (-34 °C to 163 °C)	1600 (8.1)	17.720 – 79 (450.1 – 2000)	Within limits of dimension B1. See Appendix E.	1° to 4°	N/A	12-8
NBR -20 °F to 250 °F (-29 °C to 121 °C) FKM -40 °F to 400 °F (-40 °C to 204 °C)	Up to 2500 (12.7)	314 – 15 (19 – 381)	N/A	N/A	N/A	12-9
NBR -20 °F to 250 °F (-29 °C to 121 °C) FKM -40 °F to 400 °F (-40 °C to 204 °C)	Up to 2500 (12.7)	1 – 25 (25 – 635)	N/A	N/A	N/A	12-9



03/28/06



Notes

4

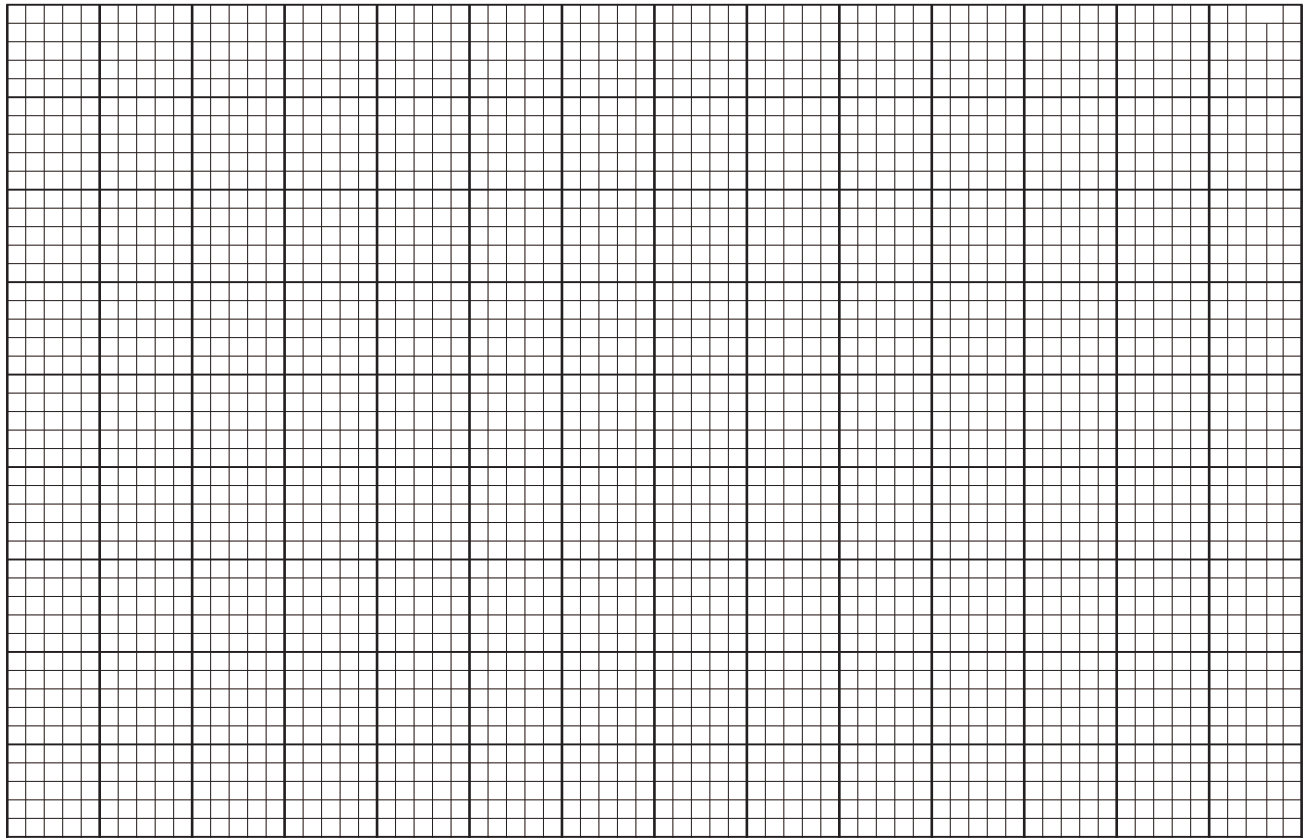

Clipper® Oil Seals

Introduction

Catalog EPS 5350/USA

Contents

Engineering	5-3
Materials	5-6
Product Offering	5-9
Part Numbering	
Nomenclature	5-9
Solid Clipper Oil Seals	
LUP, LPD, LDS Profiles.	5-14
LUPW, LPDW, LDSW	
Profiles	5-15
HP, MP Profiles.	5-16
OL Profile	5-17
ST-LUP, ST-LPD Profiles.	5-18
TSS Profile	5-19
DL Profile	5-20
RPDT Profile	5-21
P, H Profiles	5-22
SS, SDS Profiles	5-23
Clipper Sliptite Profile	5-24
TMAL, TMAS Profiles	5-25
MIST, LifeLine Profile	5-26
RUP, RPD Profiles	5-27
Split Clipper Oil Seals	5-28

Clipper Oil Seals provide superior performance in the most demanding and critical applications.

OEMs worldwide know Clipper Oil Seals for their ability to provide superior performance in the most demanding and critical applications. A one-piece molded construction and the ability to provide application-specific designs, if needed, are just a few of the reasons Clipper seals are specified for critical applications. These applications include as aircraft landing gear, military vehicles, underground mining equipment and roll chocks used in the steel industry.

Clipper seals are available for shaft diameters from 0.250" (6.35 mm) to over 65" (1651 mm) in both standard and high performance elastomer compounds. With over 10,000 tooled sizes, Clipper seals are readily available for most applications in either a solid or split design.

The most unique feature of the Clipper oil seal is nonmetallic construction. The metal case that is common with traditional lip seals is replaced with an aramid fiber and elastomer composite material.

A wide range of lip profiles are available with the aramid composite OD to suit virtually any application need. For standard profiles, see **Table 5-7** on **Page 5-10**.

Stainless Steel Springs Are Standard on all Clipper Oil Seals where the industry standard is a lower quality carbon steel. Clipper's spring material provides improved lip loading at higher temperatures and resists the rust and corrosion that is common with lower quality materials. The upgraded spring ensures consistent lip loading over the life of the seal.

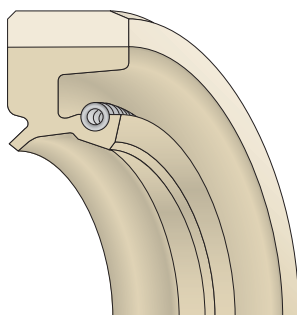

Clipper Oil Seal

5

03/28/06



Applications

Clipper Oil Seals are used in a wide range of industries including light industrial, mining, paper, steel, food processing, marine, aerospace and petrochemical.

Application equipment includes:

- Pumps
- Motors
- Gearboxes
- Crushers
- Fans
- Pillow blocks
- Runout tables
- Paper rolls
- Work rolls
- Mixers
- Compressors
- Overhead cranes
- Drag lines
- Hoists
- Elevators
- Mine cart wheels
- Flywheels
- Idler wheels
- Tapered bearings
- Custom equipment

5

Features, Advantages and Benefits

The Clipper Oil Seal can be used as a direct replacement for metal case seals and provides the following benefits:

1. Composite OD provides gasket-type seal at OD for improved sealing in worn housings. Compression plates are not required for seal retention or lip loading. The tight press fit eliminates the need for a cover plate.
2. Will not rust or corrode.
3. Consists of a seal lip and seal OD to form a one-piece molded construction across entire size range and a more robust design compared to gluing or crimping the seal lip to a metal case.
4. Resists problems caused by thermal expansion when seal case and housing are different materials.
5. Eliminates seal damage during installation. The Clipper seal is known for its user-friendly installation.
6. Nonmetallic construction allows splittable design.
7. Composite material provides unique design capabilities; i.e. flange, buttons, mounting holes.
8. Allows for faster delivery of non-stock items with no manufacturing delays caused by waiting on metal components. Seals 14" and over ship in under 10 days and typically less than four weeks for small diameter.

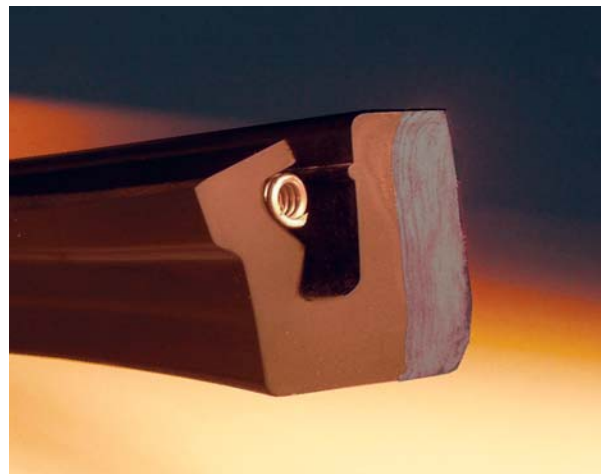

Shaft Recommendations

Material — Parker recommends a shaft material of carbon steel with a minimum hardness of Rockwell C30 (30 Rc). Soft materials such as bronze, aluminum or plastic should be avoided because they are susceptible to grooving and will cause premature seal failure. If a soft shaft material must be used, a Parker Quick Sleeve or Parker Wear Sleeve can be installed over the soft shaft material to provide a durable sealing surface. See **Section 7** for details.

Shaft Finish — Parker recommends a plunge ground finish of 8 to 17 $\mu\text{in Ra}$ (0.20 to 0.43 $\mu\text{m Ra}$) with zero lead. A shaft finish significantly smoother or rougher will shorten the service life of the seal. For additional information on shaft finish refer to **Page 2-6**.

Shaft Profile — The shaft profile should include a lead-in chamfer per the following example. The leading edge helps prevent lip roll-back and spring dumping. The leading edge and trailing edges should be free of burrs or sharp edges that could cut the contact point of the seal lip. See **Table 2-2a** on **Page 2-8** for recommended minimum chamfer length.

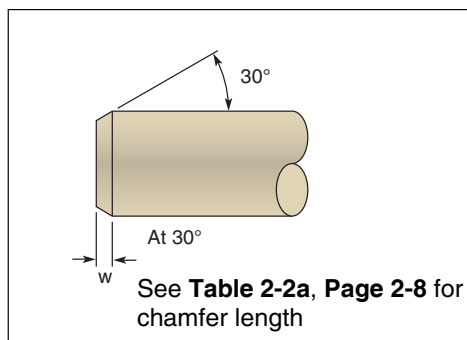

Figure 5-1. Shaft Profile

Shaft Tolerance — To ensure the proper lip-to-shaft interference is maintained, shaft diameters should fall within the tolerances specified in **Tables 5-1** and **5-2**. Shafts significantly over the tolerance will increase the underlip temperatures and lead to premature failure. An undersized shaft compromises the amount of lip interference available to maintain a positive seal.

Table 5-1. Shaft Tolerance for Inch/Fractional

Shaft Diameter	Tolerance
Up to 4.000"	$\pm.003$ "
4.001 – 6.000"	$\pm.004$ "
6.001 – 10.000"	$\pm.005$ "
Over 10.000"	$\pm.006$ "

Table 5-2. Shaft Tolerance for Metric*

Shaft Diameter	Tolerance
Up to 10 mm	+0 to -.09 mm
Over 10 – 18	+0 to -.11 mm
Over 18 – 30	+0 to -.13 mm
Over 30 – 50	+0 to -.16 mm
Over 50 – 80	+0 to -.19 mm
Over 80 – 120	+0 to -.22 mm
Over 120 – 180	+0 to -.25 mm
Over 180 – 250	+0 to -.29 mm
Over 250 – 315	+0 to -.32 mm
Over 315 – 400	+0 to -.36 mm
Over 400 – 500	+0 to -.40 mm

*ISO Standard 286-2, h11

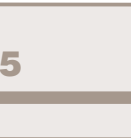

Housing Recommendations

Material — The most commonly used materials for seal housings are steel and cast iron. Care must be taken when softer housing materials such as aluminum, bronze or plastic are used.

Housing Finish — A finish range of 40 to 100 µin Ra (1.0 to 2.5 µm Ra) is recommended. The Clipper seal is more tolerant of housing finishes that are toward the upper limit than metal OD seals.

Housing Profile — A lead-in chamfer per the following example is highly recommended for all seal housings. The chamfer aligns the seal during installation and helps prevent the seal from cocking. Both corners of the chamfer should be free of burrs and sharp edges to eliminate OD damage during installation.

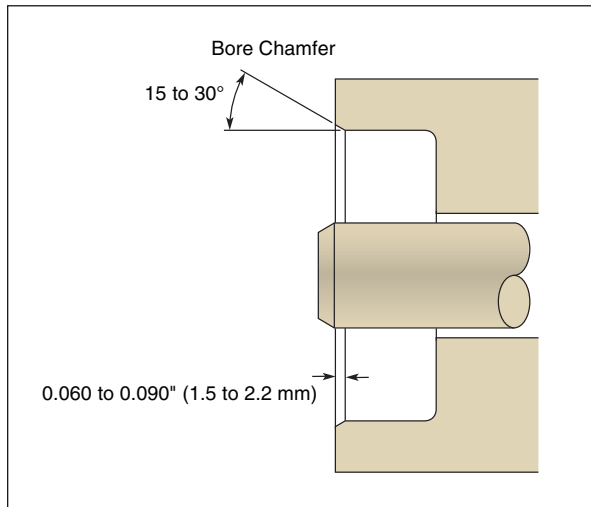

Figure 5-2. Housing Profile

Housing Tolerance — The diametrical tolerance of the housing for Clipper Oil Seals should be within the limits specified below.

Table 5-3. Housing Tolerance for Inch/Fractional

Bore Diameter	Diameter Tolerance H1	Diameter Tolerance STH1	Depth Tolerance (-0/+)
Up to 5.9	±.002	±.002	+.031
6.0 – 15.9	±.005	±.002	+.062
16.0 – 30.9	±.008	±.005	+.062
Over 31.0	±.010	±.005	+.062

Table 5-4. Housing Tolerance for Metric

Bore Diameter	Diameter Tolerance H1	Diameter Tolerance STH1	Depth Tolerance (-0/+)
Up to 150.0	±.05	±.05	+.8
151 – 403	±.13	±.05	+1.5
404 – 785	±.20	±.13	+1.5
Over 786	±.25	±.13	+1.5

5

Solid Clipper Seal Installation

1. Clean seal bore and shaft. Remove all burrs and nicks.

2. Pre-lubricate the seal ID and shaft before installing the seal into the cavity. Use a pre-lube that is compatible with the system lubricant. The pre-lube will make the seal easier to install and prevent dry running during initial start-up. **(Do not lubricate the seal OD or housing.)**

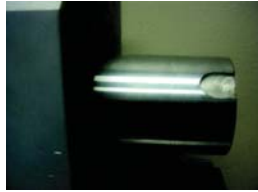

3. Protect seal lip against damage from sharp keyways, splines and screw threads. This can be done by either taping the keyway, inserting an element into the keyway or using an assembly sleeve that fits over the shaft.



4. Point seal lip in correct direction and push to edge of the counter bore.

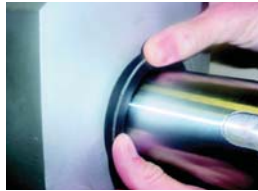

5. Start seal into cavity by finger pressure. After starting seal in housing, tap evenly with a soft-faced mallet all around until seated.



6. Finish installation by using a flat plate tool to drive seal in final position. The plate diameter should be large enough so it contacts the face of seal housing. This will ensure seal is positioned straight and perpendicular to the shaft.

Split (R Series) Clipper Seal Installation

1. Clean the equipment cavity recess area thoroughly. Remove all burrs and sharp corners. Provide adequate lead-in chamfers.

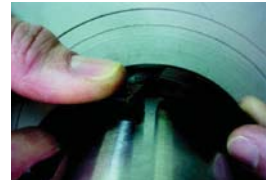

2. Apply light grease or oil coating to the shaft area where the lip will engage. **Do not apply grease or oil to seal OD or equipment bore surface.**

3. Separate the cut ends of the seal sideways so that seal forms a helix. Do not try to form the seal into a "U" shape. Separate ends far enough so that the seal can be slipped over the shaft.

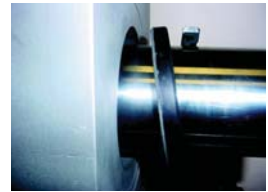

4. Insert the garter spring over the shaft, between the seal and the bore cavity, connecting the ends of the spring with the hook-and-eye connectors. Insert the garter spring into the lip carrier groove with the connection at least 45° from the split juncture. Push the seal toward the bore cavity until it touches, making sure that the split ends are well aligned and positioned at 12 o'clock.

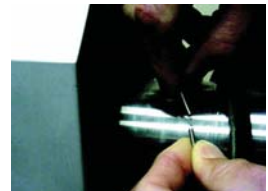

5. Start inserting the seal into the cavity with the split juncture at top, compressing the OD slightly, until the split juncture has been inserted to about one-third of its width. Continue pressing the balance of the seal into the cavity, working away from the split, until the entire seal has been started into the cavity recess. Tap evenly around the back face of the seal with a soft-faced mallet until it is completely seated.



6. Use a flat plate tool that will drive the seal flush with the housing to ensure seal is installed square and perpendicular to the shaft.

5

03/28/06

Clipper® Oil Seals Materials

Catalog EPS 5350/USA

Common Materials Used in this Product

Clipper Oil Seals are available in a wide range of materials. The following general material descriptions are for the OD material “H” and corresponding lip material “L”.

5

OD and Lip Materials

H1L5 & H1L7 — Nitrile (NBR)

Standard Nitrile is the most commonly used polymer in the rotary shaft seal industry. NBR has very good resistance to oil, fuel and alkali solutions. Nitrile offers excellent resistance to petroleum-based hydraulic fluids and is resistant to hydrocarbon solvents. Standard Nitrile has poor resistance to ozone, ketones, automotive or aircraft brake fluid, and steam or hot water. Standard Nitrile is recommended for operating in temperatures ranging from -20 to +250 °F (-29 to +121 °C) and offers good mechanical properties and abrasion resistance.

H1L50 & H1L70 — Low Temp Nitrile (NBR)

Nitrile compounds can be formulated for applications in extreme cold weather environments. These special formulations of Nitrile allow for operation at minimum temperatures ranging down to -70 °F (-57 °C), while maintaining good chemical and abrasion resistance, but the upper temperature limit is lowered to 212 °F (100 °C).

H1L20 — Carboxylated Nitrile (XNBR)

XNBR is formulated to greatly enhance tear and abrasion resistance over standard Nitrile, while maintaining similar chemical compatibility. It is used in applications where abrasive materials may collect at the point of shaft contact. XNBR is less resilient and flexible at low temperature, and offers poorer compression set resistance than standard Nitrile. Carboxylated Nitriles are recommended for operation at temperatures ranging from -30 to +250 °F (-34 to +121 °C).

H1L30 — Hydrogenated Nitrile (HNBR)

Hydrogenated Nitriles offer improved abrasion resistance, excellent chemical resistance and higher operating temperatures than standard NBR. Ozone and weather resistance, as well as resistance to hot water are also increased. HNBR compounds are recommended for operating temperatures ranging from -40 to +300 °F (-40 to +149 °C).

03/28/06

H1L8 — Neoprene (CR)

Neoprene offers very good resistance to weather, ozone and natural aging as well as good flame resistance while maintaining moderate resistance to oil and gasoline. Good abrasion, flex and cracking resistance is available with the Neoprene material. Neoprene is recommended for operating temperatures ranging from -45 to +250 °F (-43 to +121 °C).

H1L21 — Ethylene Propylene (EPDM)

EPDM offers excellent heat, ozone and sunlight resistance. EPDM offers very good low temperature flexibility, good resistance to alkalis, acids (such as acetic), and oxygenated solvents (such as MEK). Provides improved resistance to water and steam in applications where NBR and FKM exhibit poor service life. Good replacement for FKM where solvents are a problem. It is not recommended for petroleum oil. EPDM is recommended for operating temperatures of -60 to +300 °F (-51 to +149°C).

H5L16 — Fluoroelastomer (FKM)

FKM provides excellent resistance to oils, fuels and hydraulic fluids at temperatures that far exceed standard Nitrile. It also has very good resistance to flame and excellent impermeability to gases and vapors. FKM is recommended for operating temperatures that range from -40 to +400 °F (-40 to +204 °C).

Case Materials

H1, H3 — Neoprene/Aramid Composite

The aramid fiber-reinforced composite shell will fill a wide range of bore tolerances and provides a rustproof gasket-type seal at the OD. The composite case also will fill slight imperfections in the bore housing, reducing machining cost. Usually combined with a Nitrile lip material.

H5 — Fluoroelastomer/Aramid Composite

Offers the same construction benefits mentioned above. Usually combined with a Fluoroelastomer lip material.

Spring Materials

Springs are available in a wide range of materials from Parker. Clipper Oil Seal designs are furnished with 302 stainless steel springs as standard. Other spring materials are available at an additional cost. **Table 5-5** shows general operating parameters for the most common spring materials.

Table 5-5. Spring Material Parameters

Wire Type	Maximum Service Temperature		Application
	°C	°F	
Carbon Steel	120	250	General purpose
Monel 400	230	450	Saltwater
Inconel 750	675	1250	Extreme temperature
Phosphor Bronze	95	200	Saltwater
302/304 Stainless Steel	260	500	Corrosion resistance
316 Stainless Steel	315	600	Hi-temp corrosion resistance

Spring Type

For lip loading, the Clipper Oil seal uses a coil wire spring (garter spring).

Garter spring benefits:

- Provides a more uniform load to sealing lip
- Heat treated — stress relieved
- Constant load with minimum load variations
- Able to adjust the spring in the field to increase load

Two types of spring connections are used:

1. Threaded type is used on most solid seals.
2. Hook and eye type are used on splits seals because they are easier for the end user to connect during installation.

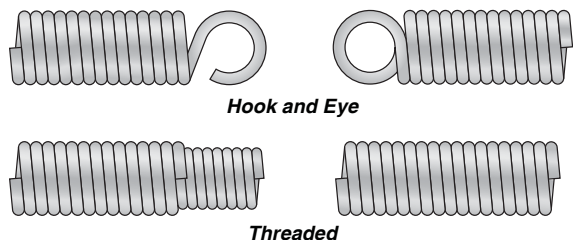

03/28/06



Table 5-6. Clipper Oil Seal Standard Material

Matl. Code Case/Lip	Material Description	Abrasion Resistance	Min. Temp	Cont. Temp	Peak. Temp
H1L5	Nitrile (75 Duro NBR) Standard NBR offering. The NBR lip material has very good resistance to oil and gasoline. Superior resistance to petroleum based hydraulic fluids. Good resistance to hydrocarbon solvents. Very good resistance to alkalis and solvents. Poor resistance to oxygenated solvents.	Very Good	-20 °F -29 °C	212 °F 100 °C	250 °F 121 °C
H1L7	Nitrile (85 Duro NBR) The L7 lip material has a lower minimum temperature capability than the L5 material.	Very Good	-30 °F -34 °C	212 °F 100 °C	250 °F 121 °C
H1L20	Carboxylated Nitrile (83 Duro XNBR) The XNBR lip material is generally tougher and more resistant to tear and abrasion than standard NBR.	Outstanding	-30 °F -34 °C	212 °F 100 °C	250 °F 121 °C
H1L30	Hydrogenated Nitrile (75 Duro HNBR) The HNBR lip material offers improved abrasion resistance, chemical resistance, higher operating temperature and better ozone resistance than standard NBR.	Outstanding	-40 °F -40 °C	250 °F 121 °C	300 °F 149 °C
ALLL5	Nitrile (75 Duro NBR) Homogenous NBR material without aramid fiber OD provides a very pliable seal that can be stretched over flanges or other obstructions on the shaft. A cover plate is recommended to keep the seal retained in the housing bore.	Very Good	-20 °F -29 °C	212 °F 100 °C	250 °F 121 °C
H1L50	Arctic Nitrile (85 Duro Low Temp NBR) Low temperature Nitrile lip material allows for lower minimum temperatures while providing good chemical and abrasion resistance.	Very Good	-50 °F -46 °C	200 °F 93 °C	212 °F 100 °C
H1L70	Alaska Nitrile (75 Duro Low Temp NBR) Same characteristics as L50, but softer with lower minimum temperature range.	Very Good	-70 °F -57 °C	200 °F 93 °C	212 °F 100 °C
H5L16	Fluoroelastomer (90 Duro FKM) FKM lip material offers outstanding resistance to high heat. Excellent resistance to oil, gasoline, petroleum hydraulic fluids and hydrocarbon solvents. Very good impermeability to gases and vapors. Very good resistance to flame, weather, oxygen, ozone and sunlight. Very little resistance to oxygenated solvents. Poor tear resistance.	Good	-40 °F -40 °C	325 °F 163 °C	400 °F 204 °C
H5L89	Fluoroelastomer (90 Duro FKM) Improved steam resistance.	Good	-40 °F -40 °C	325 °F 163 °C	400 °F 204 °C
N/P	PTFE bonded to NBR lip — PTFE layer provides improved dry running capability, chemical resistance, and reduces torque consumption.	Very Good	-20 °F -29 °C	212 °F 100 °C	250 °F 121 °C
F/P	PTFE bonded to FKM lip	Very Good	40 °F -40 °C	325 °F 163 °C	400 °F 204 °C
H1L21	Ethylene Propylene (75 Duro EPDM) Excellent heat, ozone and sunlight resistance. Very good low temperature flexibility, good resistance to alkalis, acids (such as acetic) and oxygenated solvents (such as MEK). Provides improved resistance to water and steam in applications where NBR and FKM exhibit poor service life. Good replacement for FKM where solvents are a problem. Not recommended for petroleum oil.	Very Good	-60 °F -51 °C	250 °F 121 °C	300 °F 149 °C

03/28/06

Clipper® Oil Seals Product Offering

Catalog EPS 5350/USA

Part Number Nomenclature — Clipper Oil Seals

Solid Seals

English

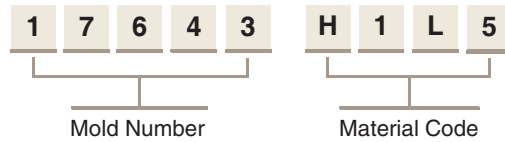

Metric

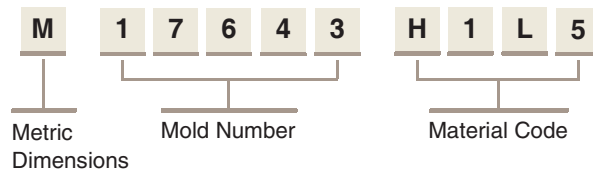

Split Seals

English

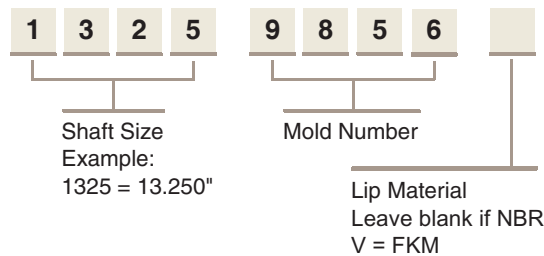

Metric

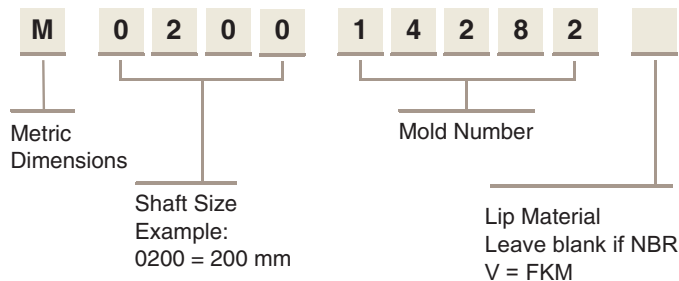











03/28/06



Profiles

The following standard Clipper Oil Seal profiles can be used in a wide range of applications for both MRO and OEM requirements. Parker’s experienced design and engineering teams are available to assist with standard and custom designs that meet both cost and performance objectives. For traditional metal clad designs, refer to Parker Oil Seals in **Section 6**.

Table 5-7. Product Profiles

Standard Profiles	Features	Applications
LUP LPD 	General purpose spring-loaded single lip seal. Features nonmetallic composite OD for damage-free installation. LPD can be furnished with/without spring retainer feature.	For oil retention or grease retention. Typical applications: electric motors, gearboxes, pumps, fans, runout tables, paper rolls, work rolls, mixers and custom equipment.
RUP RPD 	General purpose spring-loaded single lip seal. Features nonmetallic OD for damage-free installation. Available in solid or split. Splits feature a positive bore retention and require no cover plate.	Splits — for grease retention — with oil, some seepage may occur. Typical applications: electric motors, gearboxes, pumps, fans, runout tables, paper rolls, mixers, and custom equipment. Split seals are designed for applications where equipment is unable to be disassembled due to time constraints.
LUPW LPDW 	Spring-loaded single lip. Features nonmetallic composite OD for damage-free installation.	High runout conditions for applications up to 1" (25.4 mm) total eccentricity. For oil retention and low speeds.
LDS 	General purpose double lip features nonmetallic composite OD for damage-free installation. LDS profile has a primary spring-loaded lip with a non-spring-loaded secondary lip for exclusion of light dust or contamination.	For oil retention. Excludes light dust and fluid. Typical applications: electric motors, gearboxes, pumps, fans, runout tables, paper rolls, mixers, and custom equipment.
LDSW 	Specialized double lip features non-metallic composite OD for damage-free installation. Primary lip features molded in spring for lubricant retention. Springless secondary lip for excluding light dust. Floating lip accommodates high misalignment conditions.	High runout conditions up to 0.125" (3.175 mm) total eccentricity. For oil or grease retention and low speeds. Typical applications: electric motors, gearboxes, pumps, fans, runout tables, paper rolls, mixers, and custom equipment.
SDS 	General purpose springless dual lip. Features nonmetallic composite OD for damage-free installation.	For grease retention and exclusion of light dust and fluids. Typical light duty applications.
SS 	General purpose springless single lip seal. Features nonmetallic composite OD for damage-free installation.	For grease retention and exclusion of light dust and fluid. Typical light duty applications.
OL 	Spring-loaded outside lip. Nonmetallic composite ID for tight press fit on shaft. Easy to install.	Generally used in grease applications where bore rotates. Agriculture and ground-engaging equipment.
MIST STMIST w/Buttons 	Heavy duty spring-loaded single lip. MIST features nonmetallic composite OD for damage-free installation. STMIST features composite OD metal band reinforced construction for absorbing shock load and greater bore retention. Both feature molded-in spring to eliminate spring dumping.	For heavy duty applications. Work rolls, paper rolls, backup rolls and custom equipment.
STLUP STLUP w/Buttons 	Spring-loaded single lip with heavy duty metal band inserted in composite OD. ST design features metal bands for absorbing shock load and greater bore retention. Spacer buttons are available for grease purging in applications requiring back-to-back sealing.	For heavy duty applications. Work rolls, paper rolls, backup rolls and custom equipment.

03/28/06









Operating Temperature Range	Shaft Surface Speed fpm (m/s)	Shaft Size Range Inches (mm)	Maximum Shaft Dynamic Runout (TIR)	Maximum (STBM) Misalignment	Maximum Pressure psi (bar)	Page
NBR -20 °F to 250 °F -29 °C to 121 °C FKM -40 °F to 400 °F -40 °C to 204 °C	Up to 3200 (16.3)	1/4 – 62.5 (6.4 – 1587)	0.010" (0.254 mm)	0.010" (0.254 mm)	0 – 7 (0 – 0.48) <i>Depending on Shaft Speed</i>	5-14
NBR -20 °F to 250 °F -29 °C to 121 °C FKM -40 °F to 400 °F -40 °C to 204 °C	Up to 2000 (10.2)	1/2 – 65 (13 – 1651)	0.010" (0.254 mm)	0.010" (0.254 mm)	0 – 3 (0 – 0.20) <i>Depending on Shaft Speed</i>	5-27
NBR -20 °F to 250 °F -29 °C to 121 °C FKM -40 °F to 400 °F -40 °C to 204 °C	Up to 1000 (5.1) <i>Speed Depends on Runout</i>	1 – 50 (41 – 1270)	0.020 – 1.125" (0.508 – 28.58 mm)	0.020 – 1.125" (0.508 – 28.58 mm)	0 – 7 (0 – 0.48) <i>Depending on Shaft Speed</i>	5-15
NBR -20 °F to 250 °F -29 °C to 121 °C FKM -40 °F to 400 °F -40 °C to 204 °C	Up to 2500 (12.7)	3/4 – 25 (19 – 635)	0.010" (0.254 mm)	0.010" (0.254 mm)	0 – 7 (0 – 0.48) <i>Depending on Shaft Speed</i>	5-14
NBR -20 °F to 250 °F -29 °C to 121 °C FKM -40 °F to 400 °F -40 °C to 204 °C	Up to 2500 (12.7) <i>Speed Depends on Runout</i>	3/4 – 25 (19 – 635)	0.020 – 0.125" (0.508 – 3.175 mm)	0.020 – 0.125" (0.508 – 3.175 mm)	0 – 3 (0 – 0.20) <i>Depending on Shaft Speed</i>	5-15
NBR -20 °F to 250 °F -29 °C to 121 °C FKM -40 °F to 400 °F -40 °C to 204 °C	Up to 2000 (10.2)	1/2 – 12.835 (12.7 – 326)	0.010" (0.254 mm)	0.010" (0.254 mm)	0 – 7 (0 – 0.48) <i>Depending on Shaft Speed</i>	5-23
NBR -20 °F to 250 °F -29 °C to 121 °C FKM -40 °F to 400 °F -40 °C to 204 °C	Up to 2000 (10.2)	1/4 – 6 (6.4 – 152)	0.010" (0.254 mm)	0.010" (0.254 mm)	0 – 7 (0 – 0.48) <i>Depending on Shaft Speed</i>	5-23
NBR -20 °F to 250 °F -29 °C to 121 °C FKM -40 °F to 400 °F -40 °C to 204 °C	Up to 1000 (5.1)	1 – 65 (25 – 1651)	0.010" (0.254 mm)	0.010" (0.254 mm)	0 – 7 (0 – 0.48) <i>Depending on Shaft Speed</i>	5-17
NBR -20 °F to 250 °F -29 °C to 121 °C FKM -40 °F to 400 °F -40 °C to 204 °C	Up to 3200 (16.3)	6 – 48 (152 – 1219)	0.010" (0.254 mm)	0.010" (0.254 mm)	0 – 7 (0 – 0.48) <i>Depending on Shaft Speed</i>	5-26
NBR -20 °F to 250 °F -29 °C to 121 °C FKM -40 °F to 400 °F -40 °C to 204 °C	Up to 3200 (16.3)	5 – 57.875 (127 – 1470)	0.010" (0.254 mm)	0.010" (0.254 mm)	0 – 7 (0 – 0.48) <i>Depending on Shaft Speed</i>	5-18



03/28/06

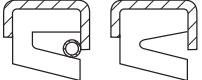

Table 5-7. Product Profiles (Continued)

Standard Profiles	Features	Applications
LifeLine 	Spring-loaded single lip features heavy duty rubber covered metal insert. LifeLine features metal insert for absorbing shock load and greater bore retention. LifeLine features molded-in spring to eliminate spring dumping.	For heavy duty applications. Work rolls, paper rolls, backup rolls and custom equipment.
P 	Features nonmetallic composite OD for damage-free installation. The P wiper scraper lip extends outside the bore face.	Applications for reciprocating service and low speed.
H 	Features nonmetallic composite OD for damage-free installation. Shallow cavity rod wiper designed for excluding dust and contamination.	Applications for rotary and reciprocating service. Reciprocating applications may require bore plate.
HP 	High pressure with a fluoroelastomer sealing element, outer metal case, and a PTFE backup element for pressure. Standard with carbon steel case. Stainless steel and other alloys available.	The high pressure (HP) seal is designed to handle rotary and reciprocating motions at high speeds and temperatures. Typical applications: pumps, compressors and custom equipment.
MP 	The standard MP is a rubber covered metal design, spring-loaded. Standard profile material FKM, other materials available upon request.	MP is typically used in grease and oil retention applications. Typical applications: electric motors, gearboxes, pumps, fans, mixers and custom equipment.
DL 	Spring-loaded dual lip seal. Features nonmetallic composite OD for damage-free installation.	Dual spring-loaded lips are used when the separation of two fluids is required. The design is also used for high contamination applications in keeping out a dirty environment.
Clipper Sliptite 	The Clipper Sliptite utilizes a layer of PTFE bonded to the sealing lip to reduce excessive wearing on the shaft and seal. Features nonmetallic composite OD.	With the PTFE lip the seal can be used in dry running applications, at higher speeds, and accepts a broader range of chemical compatibility. Typical applications: electric motors, gearboxes, pumps, fans and custom equipment.
TMAL TMAS 	Features a stainless steel outer case. TMAL contains a machined PTFE spring-loaded sealing element. TMAS contains a machined PTFE non-spring-loaded sealing element.	TMAL & TMAS seals are designed for corrosive chemical service and FDA application.
RPDT 	Spring-loaded single lip seal. Features tapered heel. Available in splits only.	Pillow blocks.
TSS 	Features nonmetallic composite OD for damage-free installation. Soft flexible lip provides low friction sealing contact to give extended service life.	Typical applications: overhead cranes in steel mills, rotary drilling crown and travel blocks, draglines, hoists and elevators. Also used on mine cart wheels, flywheels, idler wheels and tapered bearings.

5

Operating Temperature Range	Shaft Surface Speed fpm (m/s)	Shaft Size Range Inches (mm)	Maximum Shaft Dynamic Runout (TIR)	Maximum (STBM) Misalignment	Maximum Pressure psi (bar)	Page
NBR -20 °F to 250 °F -29 °C to 121 °C FKM -40 °F to 400 °F -40 °C to 204 °C	Up to 3200 (16.3)	6 – 48 (152 – 1219)	0.010" (0.254 mm)	0.010" (0.254 mm)	0 – 7 (0 – 0.48) <i>Depending on Shaft Speed</i>	5-26
NBR -20 °F to 250 °F -29 °C to 121 °C FKM -40 °F to 400 °F -40 °C to 204 °C	Reciprocating: Up to 300 (1.5)	3/8 – 30 (10 – 762)	N/A	0.008" (0.20 mm)	0	5-22
NBR -20 °F to 250 °F -29 °C to 121 °C FKM -40 °F to 400 °F -40 °C to 204 °C	Rotary: Up to 2000 (10.2) Reciprocating: Up to 300 (1.5)	3/8 – 30 (10 – 762)	N/A	0.008" (0.20 mm)	0	5-22
NBR -20 °F to 250 °F -29 °C to 121 °C FKM -40 °F to 400 °F -40 °C to 204 °C	Up to 4000 (20.3)	1/4 – 8 (6.4 – 203)	0.003" (0.076 mm)	0.003" (0.076 mm)	300 (20)	5-16
NBR -20 °F to 250 °F -29 °C to 121 °C FKM -40 °F to 400 °F -40 °C to 204 °C	Up to 4000 (20.3)	1/4 – 12.500 (6.4 – 317)	0.005" (0.127 mm)	0.005" (0.127 mm)	100 (7)	5-16
NBR -20 °F to 250 °F -29 °C to 121 °C FKM -40 °F to 400 °F -40 °C to 204 °C	Up to 2000 (10.2)	1/4 – 4 (6.4 – 101)	0.010" (0.254 mm)	0.010" (0.254 mm)	0 – 7 (0 – 0.48) <i>Depending on Shaft Speed</i>	5-20
NBR -20 °F to 250 °F -29 °C to 121 °C FKM -40 °F to 400 °F -40 °C to 204 °C	Up to 5000 (25.4)	1/2 – 10 (12.7 – 254)	0.010" (0.254)	0.010" (0.254 mm)	0 – 7 (0 – 0.48) <i>Depending on Shaft Speed</i>	5-24
PTFE -40 °F to 500 °F -40 °C to 260 °C	Up to 2500 (12.7)	1/2 – 14 (12.7 – 355)	0.006" (0.152 mm)	0.006" (0.152 mm)	0 – 7 (0 – 0.48) <i>Depending on Shaft Speed</i>	5-25
NBR -20 °F to 250 °F -29 °C to 121 °C FKM -40 °F to 400 °F -40 °C to 204 °C	Up to 2000 (10.2)	3.375 – 16 (85.73 – 406)	0.010" (0.254 mm)	0.010" (0.254 mm)	0	5-21
NBR -20 °F to 250 °F -29 °C to 121 °C FKM -40 °F to 400 °F -40 °C to 204 °C	Up to 2000 (10.2)	1.274 – 17.500 (32.36 – 445)	0.010" (0.254 mm)	0.010" (0.254 mm)	0	5-19



03/28/06



Clipper® Oil Seals

LUP, LPD, LDS Profiles

Catalog EPS 5350/USA

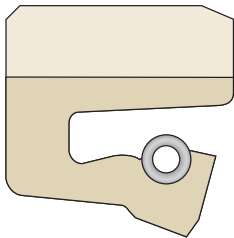

LUP

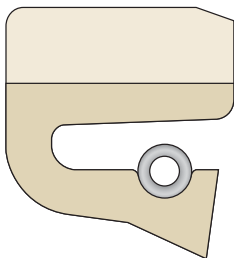

LPD

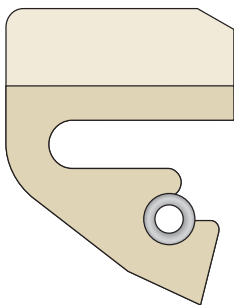

LPD — Spring Retainer

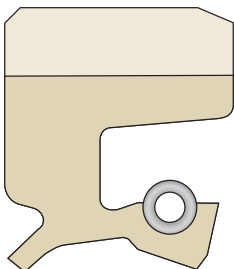

LDS

General Purpose Profiles

LUP/LPD — General purpose spring-loaded single lip seal. Features nonmetallic composite OD for damage-free installation. LPD can be furnished with/without spring retainer feature.

LDS — General purpose double lip features nonmetallic composite OD for damage-free installation. LDS profile has a primary spring-loaded lip with a non-spring-loaded secondary lip for exclusion of light dust or contamination.

Application

For oil and grease applications.

Typical applications: electric motors, gearboxes, pumps, fans, runout table, work rolls, paper rolls, mixers and custom equipment.

Technical Data

Operating Temperature Range

NBR: -20 to 250 °F (-29 to 121 °C)

FKM: -40 to 400 °F (-40 to 204 °C)

Common Materials

NBR – H1L5

HNBR – H1L20

XNBR – H1L30

FKM – H5L16

Shaft Surface Speed

LUP/LPD — Up to 3200 fpm (16.25 m/s)

LDS — Up to 2500 fpm (12.7 m/s)

Maximum Pressure

0 to 7 psi (0 to 0.48 bar), depending on shaft speed

Size Range

Available shaft diameter range is 0.375 to 65 inches (10 to 1651 mm).

Important: For full listings of standard sizes, see **Appendices B and C.**

03/28/06

Clipper® Oil Seals

LUPW, LPDW, LDSW Profiles

Catalog EPS 5350/USA

LUPW, LPDW and LDSW Profiles

LUPW/LPDW — Spring-loaded single lip. Features nonmetallic composite OD for damage-free installation.

LDSW — Specialized double lip features nonmetallic composite OD for damage-free installation. Primary lip features molded-in springs for lubrication retention. Springless secondary lip for excluding light dust. Floating lip accommodates high misalignment conditions.

Application

Most commonly used for oil or grease retention where high shaft misalignment is present. LUPW and LPDW accommodate misalignment by use of extended lip profile and may require a wider than normal bore depth to avoid interference of the lip.

Type LDSW accommodates misalignment using a geometry that allows the lip to float with the shaft.

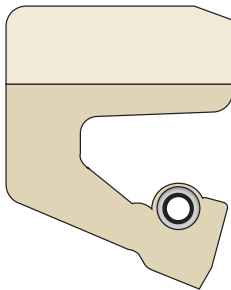

LUPW

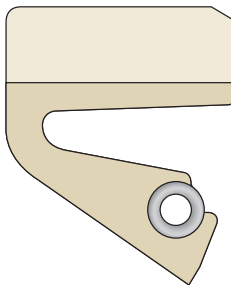

LPDW

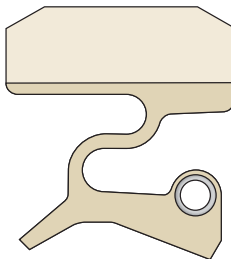

LDSW

Technical Data

Operating Temperature Range

NBR: -20 to 250 °F (-29 to 121 °C)

FKM: -40 to 400 °F (-40 to 204 °C)

Common Materials

NBR – H1L5

HNBR – H1L20

XNBR – H1L30

FKM – H5L16

Shaft Surface Speed

LUPW/LPDW — Up to 1000 fpm (5.1 m/s)

LDSW — 2500 fpm (12.7 m/s)

Maximum Pressure

LUPW/LPDW— 0 to 7 psi (0 to 0.48 bar), depending on shaft and runout

LDSW— 0 to 3 psi (0 to 0.21 bar), depending on shaft speed and runout

Size Range

Available shaft diameter range is 0.1 to 65 inches (25 to 1651 mm).

Important: For full listings of standard sizes, see **Page B-86**

03/28/06

Clipper® Oil Seals

HP, MP Profiles

Catalog EPS 5350/USA

5

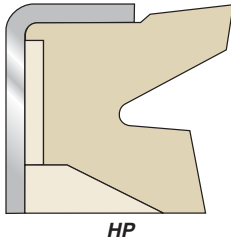

HP

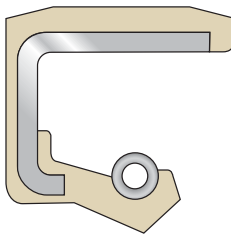

MP

HP and MP Profiles

HP — High pressure with a fluoroelastomer sealing element, outer metal case, and a PTFE backup element for pressure. Standard with carbon steel case. Stainless steel and other alloys available.

MP — The standard MP is a rubber covered metal design, spring-loaded. Standard profile material FKM, other materials available upon request.

Application

HP — Typical applications: oil retention in rotary and oscillating pumps, compressors and custom equipment.

MP — Typical applications: for oil pumps, compressors and custom equipment.

Technical Data

Operating Temperature Range

FKM: -40 to 400 °F (-40 to 204 °C)

Shaft Surface Speed

HP — Up to 4000 fpm (20.3 m/s)

MP — Up to 4000 fpm (20.3 m/s)

Maximum Pressure

HP — 100 to 300 psi (7 to 20 bar)

PV Limit (pressure * velocity) — 300,000

MP — 0 to 100 psi (0 to 7 bar)

PV Limit (pressure * velocity) — 100,000

Size Range

HP — 1/4 to 8 inches (6.4 to 203 mm)

MP — 1/4 to 12.500 inches (6.4 to 317 mm)

Important: For full listings of standard sizes, see **Appendices B and C**.

03/28/06

Clipper® Oil Seals

OL Profile

Catalog EPS 5350/USA

OL Profile

Outside Lip (OL) — Spring-loaded outside lip. Non-metallic composite ID for tight press fit on shaft. Easy to install.

Application

For positive retention of grease or oil in applications where shaft is stationary and the seal housing rotates, such as conveyors and agricultural and ground engaging equipment. Bore finish is critical since it serves as the dynamic sealing surface.

Technical Data

Operating Temperature Range

NBR: -20 to 250 °F (-29 to 121 °C)

FKM: -40 to 400 °F (-40 to 204 °C)

Shaft Surface Speed

Up to 1000 fpm (5.1 m/s)

Maximum Pressure

0 to 7 psi (0 to 0.48 bar)

Size Range

Available shaft diameter range is 1 to 65 inches (25 to 1651 mm).

Important: For full listings of standard sizes, see **Appendices B and C**.

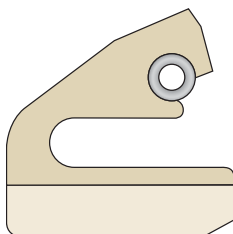

OL

5

03/28/06

Clipper® Oil Seals

ST-LUP, ST-LPD Profiles

Catalog EPS 5350/USA

5

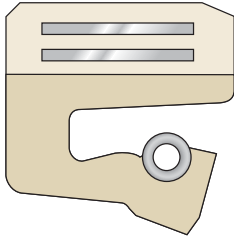

ST-LUP / ST-LPD

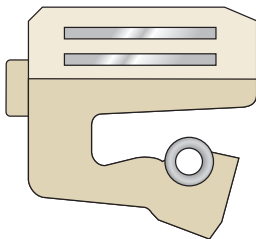

ST-LUP with Button Profile

ST-LUP and ST-LPD Profiles

ST-LUP/ST-LPD — Spring-loaded single lip with heavy duty metal band inserted in composite OD. ST design features metal bands for absorbing shock load and greater bore retention. Spacer buttons are available for grease purging in applications requiring back-to-back sealing.

Application

For heavy duty applications, work rolls, paper rolls, backup rolls and custom equipment.

Technical Data

Operating Temperature Range

NBR: -20 to 250 °F (-29 to 121 °C)

Shaft Surface Speed

Up to 3200 fpm (16.3 m/s)

Maximum Pressure

0 to 7 psi (0 to 0.48 bar), depending on shaft speed

Size Range

Available shaft diameter range is 4 to 65 inches (101 to 1270 mm).

Part Numbering

Part number is mold-specific with material used as the suffix.

14872 STHIL5

Important: For full listings of standard sizes, see **Appendices B and C**.

03/28/06

Clipper® Oil Seals TSS Profile

Catalog EPS 5350/USA

TSS Profile

TSS — Features nonmetallic composite OD for damage-free installation. Soft flexible lip provides low friction sealing friction sealing contact to give extended service life.

Application

Typical applications: overhead cranes in steel mills, rotary drilling crown and travel blocks, draglines, hoists and elevators. Also used on mine cart wheels, flywheels and idler wheels.

Technical Data

Operating Temperature Range

NBR: -20 to 250 °F (-29 to 121 °C)

FKM: -40 to 400 °F (-40 to 204 °C)

Shaft Surface Speed

Up to 2000 fpm (10.2 m/s)

Maximum Pressure

0 psi

Size Range

1.274 to 17.500 inches (32.36 to 445 mm)

Important: For full listings of standard sizes, see **Appendices B and C.**

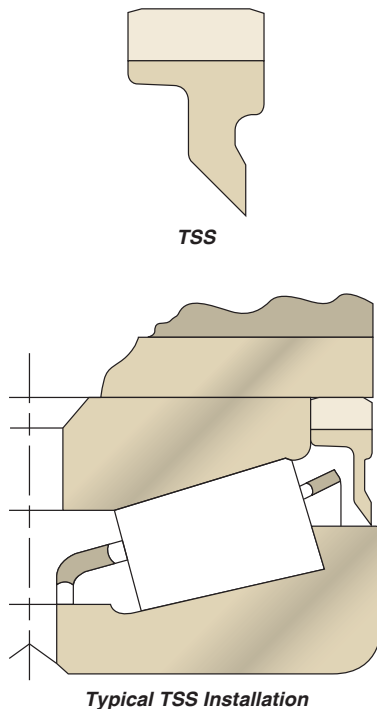

5

03/28/06

Clipper® Oil Seals

DL Profile

Catalog EPS 5350/USA

DL Profiles

DL — Spring-loaded dual lip seal. Features nonmetallic composite OD for damage-free installation.

Application

Dual spring-loaded lips are used when the separation of two fluids is required. The design is also used for high contamination applications in keeping out a dirty environment.

Technical Data

Operating Temperature Range

NBR: -20 to 250 °F (-29 to 121 °C)
FKM: -40 to 400 °F (-40 to 204 °C)

Common Materials

NBR – H1L5
HNBR – H1L20
XNBR – H1L30
FKM – H5L16

Shaft Surface Speed

Up to 2000 fpm (10.2 m/s)

Maximum Pressure

0 to 7 psi (0 to 0.48 bar), depending on shaft speed

Important: Contact Customer Service for information on size availability.

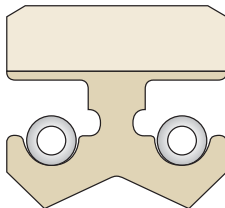

DL

5

03/28/06

Clipper® Oil Seals

RPDT Profile

Catalog EPS 5350/USA

RPDT Profile

Spring-loaded single lip seal. Features tapered heel. Available in splits only.

Application

Typical applications: pillow blocks.

Technical Data

Operating Temperature Range

NBR: -20 to 250 °F (-29 to 121 °C)

Common Materials

NBR – ALLL5

Shaft Surface Speed

Up to 2000 fpm (10.16 m/s)

Maximum Pressure

0 psi

Important: For full listings of standard sizes, see **Appendix D**.

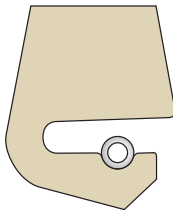

RPDT

5

03/28/06

Clipper® Oil Seals

P, H Profiles

Catalog EPS 5350/USA

5

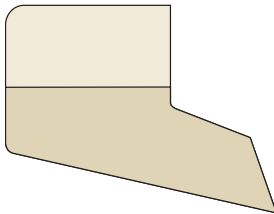

P

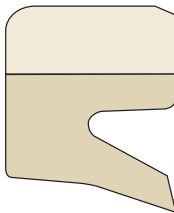

H

P and H Profiles

P — Features nonmetallic composite OD for damage-free installation. The P wiper scraper lip extends outside the bore face.

H — Features nonmetallic composite OD for damage-free installation. Shallow cavity rod wiper designed for excluding dust and contamination.

Application

P Wiper — Used in reciprocating applications.

H Wiper — Used in reciprocating and rotary applications.

Note: Reciprocating application may require bore plate.

Technical Data

Operating Temperature Range

NBR: -20 to 250 °F (-29 to 121 °C)

FKM: -40 to 400 °F (-40 to 204 °C)

Shaft Surface Speed

P Wiper — Up to 300 fpm reciprocating (1.5 m/s)

H Wiper — Up to 300 fpm reciprocating (1.5 m/s), 2000 fpm rotary (10.2 m/s)

Maximum Pressure

0 psi

Size Range

P Wiper — 3/8 to 30 inches (9.5 to 762 mm)

H Wiper — 3/8 to 30 inches (9.5 to 762 mm)

Important: For full listings of standard sizes, see **Appendices B and C**.

03/28/06

Clipper® Oil Seals

SS, SDS Profiles

Catalog EPS 5350/USA

SS and SDS Profiles

SS — General purpose springless single lip seal. Features nonmetallic composite OD for damage-free installation.

SDS — General purpose springless dual lip. Features nonmetallic composite OD for damage-free installation.

Application

For grease retention and exclusion of light dust and fluids. Typical light duty applications.

Technical Data

Operating Temperature Range

NBR: -20 to 250 °F (-29 to 121 °C)

FKM: -40 to 400 °F (-40 to 204 °C)

Common Materials

NBR – H1L5

HNBR – H1L20

XNBR – H1L30

FKM – H5L16

Shaft Surface Speed

Up to 2000 fpm (10.2 m/s)

Maximum Pressure

0 to 7 psi (0 to 0.48 bar), depending on shaft speed

Size Range

SS — 1/4 to 6 inches (6.4 to 152 mm)

SDS — 1/2 to 12.835 inches (12.7 to 326 mm)

Important: For full listings of standard sizes, see **Appendices B and C.**

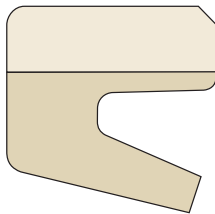

SS

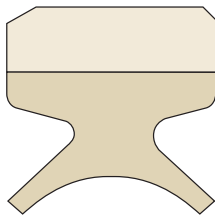

SDS

5

03/28/06

Clipper® Oil Seals

Clipper Sliptite Profile

Catalog EPS 5350/USA

5

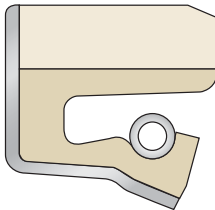

Clipper Sliptite

Clipper Sliptite Profiles

Clipper Sliptite — The Clipper Sliptite utilizes a layer of PTFE bonded to the sealing lip to reduce excessive wearing on the shaft and seal. Features nonmetallic composite OD.

Application

With the PTFE lip, the seal can be utilized in dry running applications, at higher speeds, and exhibits a broader range of chemical compatibility: electric motors, gearboxes, pumps, fans and custom equipment.

Technical Data

Operating Temperature Range

NBR: -20 to 250 °F (-29 to 121 °C)

FKM: -40 to 400 °F (-40 to 204 °C)

Common Materials

NBR – H1L5

HNBR – H1L20

XNBR – H1L30

FKM – H5L16

Shaft Surface Speed

Up to 5000 fpm (25.4 m/s)

Maximum Pressure

0 to 7 psi (0 to 0.48 bar), depending on shaft speed

Important: For full listings of standard sizes, see **Appendices B and C.**

03/28/06

Clipper® Oil Seals TMAL, TMAS Profiles

Catalog EPS 5350/USA

TMAL and TMAS Profiles

TMAL — Features a stainless steel outer case containing a machined PTFE spring-loaded sealing element.

TMAS — Features a stainless steel outer case containing a machined PTFE non-spring-loaded sealing element.

Application

TMAL and TMAS seals are designed for corrosive chemical service and FDA application.

Technical Data

Operating Temperature Range

PTFE: -40 to 500 °F (-40 to 260 °C)

Common Materials

Outer Case — Stainless Steel
Sealing Element — PTFE

Shaft Surface Speed

Up to 2500 fpm (12.7 m/s)

Maximum Pressure

0 to 7 psi (0 to 0.48 bar), depending on shaft speed

Important: For full listings of standard sizes, see **Appendices B and C.**

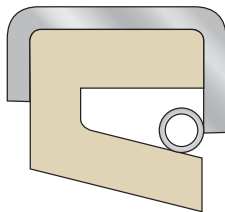

TMAL

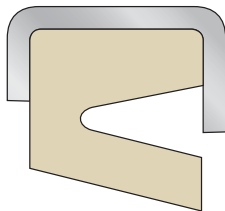

TMAS

5

03/28/06

Clipper® Oil Seals

MIST Profile, LifeLine

Catalog EPS 5350/USA

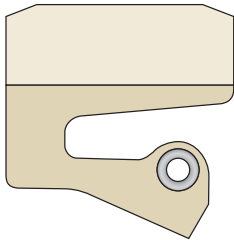

MIST

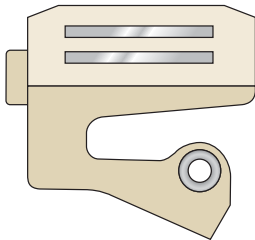

MIST ST with Button

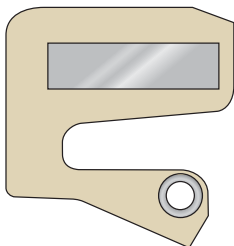

LifeLine

The above profiles available with spacer buttons for grease purging in applications requiring back-to-back sealing.

MIST, MIST ST and LifeLine Profiles

MIST — Heavy duty spring-loaded single lip. Features nonmetallic composite OD for damage-free installation. MIST features molded-in spring to eliminate spring dumping.

STMIST — Heavy duty spring-loaded single lip. Features composite OD metal band reinforced construction for absorbing shock load and greater bore retention. STMIST features molded-in spring to eliminate spring dumping.

LifeLine — Spring-loaded single lip features heavy duty rubber covered metal insert. LifeLine features metal insert for absorbing shock load and greater bore retention. LifeLine features molded-in spring to eliminate spring dumping.

Application

For heavy duty applications, work rolls, paper mills, backup rolls and custom equipment.

Technical Data

Operating Temperature Range

NBR: -20 to 250 °F (-29 to 121 °C)

Common Materials

NBR – H1L5
HNBR – H1L20
XNBR – H1L30
FKM – H5L16

Shaft Surface Speed

Up to 3200 fpm (16.3 m/s)

Maximum Pressure

0 to 7 psi (0 to 0.48 bar), depending on shaft speed

Size Range

Available shaft diameter range is 5 to 65 inches (127 to 1651 mm).

Important: For full listings of standard sizes, see **Appendices B and C.**

03/28/06

Clipper® Oil Seals

RUP, RPD Profiles

Catalog EPS 5350/USA

RUP/RPD and RPD Profiles

RUP/RPD — General purpose spring-loaded, single lip. Features nonmetallic OD for damage-free installation. Available in solid or split.

Splits — Feature a positive bore retention and require no cover plate.

Application

Typical applications: motors, gearboxes, pumps, fans, industrial rolls and custom equipment. Split seals are designed for applications where equipment is unable to be disassembled due to time constraints.

Technical Data

Operating Temperature Range

NBR: -20 to 250 °F (-29 to 121 °C)

FKM: -40 to 400 °F (-40 to 204 °C)

Common Materials

NBR – H1L5

HNBR – H1L30

XNBR – H1L20

FKM – H5L16

Shaft Surface Speed

Up to 2000 fpm (10.2 m/s)

Maximum Pressure

0 to 3 psi (0 to 0.20 bar), designed for vented applications (solid design), 0 psi on split designs

Size Range

Split seal available shaft diameter range is 0.500 to 65 inches (13 to 1651 mm).

Part Numbering

When ordering, use the shaft diameter of the split seal as the prefix to the mold number.

4673 H1L5 is the part number for a solid 4673 seal in NBR.

1100 4673 is the part number for a 4673 seal split down for 11" shaft in NBR.

1100 4673 V is the part number for a 4673 seal split down for 11" shaft in FKM.

Important: For full listings of standard sizes, see **Appendices B, C and D.**

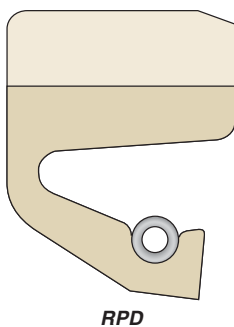
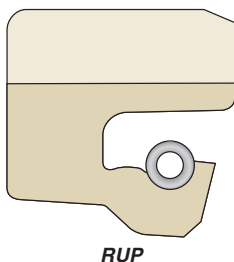

5

Clipper® Oil Seals

Split Clipper Oil Seals

Catalog EPS 5350/USA

Description

Split Clipper Oil Seals have the same superior characteristics as solid, Clipper Oil Seals, but are factory-split at one place in the circumference. This permits installation over the side of a shaft, rather than over the end, and often can save dismantling the equipment in order to replace the existing seals.

Solid Clipper Oil Seals should be used whenever practical to provide maximum bearing protection in rotating shaft applications. However, installing a solid seal in a failed application can be costly and time consuming. In such cases, Split Clipper Oil Seals can be used to minimize unscheduled downtime, specifically where equipment cannot be uncoupled. These seals will provide long and efficient service until major or scheduled machine overhaul permits convenient installation of a regular non-split seal.

Split Clipper Oil Seals are available in Series R, RPD and RUP profiles, depending upon shaft diameter (see **Page 5-27**). They are widely used as replacement seals because they provide superior bearing protection and embody a unique principle of design. The tough, dense outer case and a soft, flexible lip are concentrically molded as a single unit. The seal's nonmetallic outer case forms a leak-free, press fit in the housing, conforming to minor surface irregularities.

Split Clipper seals provide excellent retention of grease and light oil splash. Some weepage in oil splash applications may occur.

Advantages

- Saves costly downtime. Speed repairs.
- Easy installation with no special tools required.
- No backup plates required.
- Corrosion-resistant. Reduce bore surface seizing.
- Stainless steel coil garter spring helps keep split junction tight and compensates for minor shaft irregularities.
- Flat lip contact design compensates for minor split-end misalignment.



5

03/28/06

Important Notes

For Split Clipper Oil Seals to work with reasonable efficiency, the seals must be split at the factory. A precisely calculated wedge-shaped segment must be removed from a pre-molded, oversized seal to assure proper bore cavity and shaft fit. It is not a simple knife-cut. **DO NOT ATTEMPT TO ALTER THE RECEIVED SIZE ON THE JOB SITE.**

Split Clipper Oil Seals are made for use in horizontal shaft applications for grease and oil. The seals are not recommended for bottom installation on vertical shafts where oil is used. The seals can be used for top installation on vertical shafts.

Parker does not recommend Split Clipper Oil Seals for use in pressure service, as the unsupported split junction area will separate, causing leakage.

Split Clipper Oil Seals are not recommended for abnormal shaft runouts or misalignments.

Converting to Split Clipper Oil Seals

Retrofitting Existing Equipment

To convert existing equipment from solid oil seals to Split Clipper Oil Seals, the following procedure should be followed:

1. Establish the nominal shaft diameter bore diameter and housing depth of existing seal or equipment. The original equipment drawings are most helpful. Note that no backup plate is required with Split Clipper Oil Seals.
2. Refer to engineering and design data and the size listings. Determine equipment operating conditions for shaft speed, runout, temperature, etc., to verify they are within recommended application limits.

New Equipment Design

Manufacturers of equipment who wish to provide field service interchangeability with solid oil seal, should consider the following:

1. Design equipment to provide adequate axial spacing, a minimum 2" (5.08 cm), between the outside bore cavity face and adjacent equipment components. This is needed to provide room for removal of the old seal and installation of the new seal.

2. Select a nonmetallic Clipper Seal for original installation having the same shaft, bore and width sizes as the appropriate Split Oil Seal listed. A Clipper Oil Seal should be used for original installation because removal of a conventional metallic-cased oil seal and splitting it to get it off the shaft, would be extremely difficult in the confined space usually encountered.

3. Split Clipper Oil Seals are sized for a press-fit engagement when installed in the bore. It is most important that all equipment dimensions, tolerances, entrance chamfer and mating metal finishes be maintained within limitations specified.

How to Calculate Solid to Split Oil Seals

As an example, assume the current equipment has the following dimensions:

Shaft Diameter = 2.000"
 Housing Diameter = 2.813"
 Housing Width = .375"

To see if a split seal size is available, first check the listing in **Appendix B**. Find the dimension matching the size requirement which has "SPLIT" listed as seal type. For the dimensions above, Part number 0200 7081 is the correct size and can be found in **Appendix B**.

If the split seal size is not listed in **Appendix B** the method below can be used for less popular sizes.

Using Conversion Chart In Appendix D

The solid to split seal calculation chart (**Appendix D**) consists of the following columns. See **Table 5-8** for example.

Column A = Shaft Diameter Range (Min & Max)
 Column B = Mold Number
 Column C = Dimension added to shaft diameter, (Column A) to determine Split OD dimension
 Column D = Width of the seal

Step 1. To determine if shaft size is available find a matching shaft diameter range in column A. In this example all sizes in Table 5.8 can be split for a 2.000" shaft.

Step 2. Subtract the housing O.D. by the shaft diameter. If result is listed in Column C, a seal with the correct O.D. can be supplied. In the example this dimension is .813".

$$(OD - ID = \text{Column C})$$

Example: 2.813 - 2.000 = 0.813

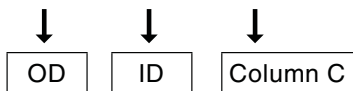

Step 3. Locate a Mold number in column B that matches BOTH the shaft diameter range and the Column C number from the formula. In this example Mold Number 7081 matches both columns and can be split to the required size.

Step 4. Use dimension in Column D for available seal width.

To order the 7081 split for a 2" shaft, a prefix is added to the solid seal mold number to form the part number. See example below:

Split Part No. **Dimensions**
 0200 7081 2.000" x 2.813" x .375"

Additional examples:

Split Part No. **Dimensions**
 0618 4548 6.188" x 7.437" x .615"
 1087 3553 10.875" x 12.875" x .812"
 M 0130 3788 130 mm x 150 mm x 9.5 mm

Contact customer service for assistance if needed.

Table 5-8. Split Seal Guide

Column A		Column B	Column C	Column D
Shaft Diameter		Mold No.	Add to Shaft Dia. for Seal OD	Seal Width
Min.	Max.			
1.875	- 2.000	3625	1.000	0.438
1.875	- 2.000	7081	0.813	0.375
1.875	- 2.000	7131	0.750	0.375
1.875	- 2.000	18759	1.000	0.500
2.000	- 2.125	3930	1.250	0.500
2.000	- 2.125	4868	1.000	0.375
2.000	- 2.125	6207	1.184	0.500
2.000	- 2.125	19359	1.375	0.500

Important: For full listings of standard sizes and splittable solid seals, see **Appendix D**.

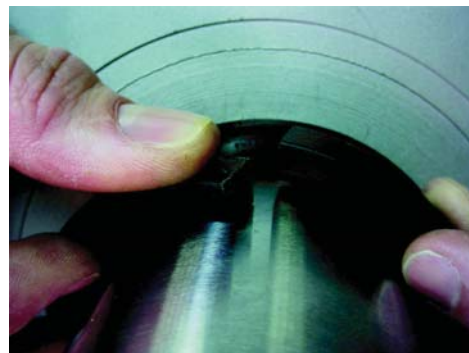

03/28/06

Parker Oil Seals

Introduction

Catalog EPS 5350/USA

Contents

Engineering	6-2
Materials	6-5
Product Offering	6-9
Part Numbering	
Nomenclature	6-9
Parker Oil Seals	
Spring-Loaded Oil Retention Profiles	6-12
Springless Grease Retention Profiles	6-13
Dual Spring-Loaded Lip Profiles	6-14
Medium Pressure Profiles	6-15
Cassette Profiles	6-16
High Eccentricity Single Lip Profiles	6-17
Rotating Bore Profiles	6-18
PTFE/Elastomer Profiles	6-19
Wiper and Scraper Profiles	6-20



What makes Parker Oil Seals different?

Parker Oil Seals are backed with over 100 years of seal design experience. Available in the common metal OD construction for inch requirements and rubber covered OD for metric requirements. In addition to standard profiles, custom designs are available for O.E. and end user applications

Applications

Parker Oil Seal designs offer solutions to virtually any rotary sealing challenge. Along with seals that retain oil, grease and other viscous fluids, Parker offers seal designs to accommodate:

- High eccentricity
- Separation of two fluids
- Dry running
- High pressure
- Wiping and scraping

Also available are designs that exclude contaminants such as light dust, water splash, gravel and mud.

Parker Oil Seals can be found in:

- Gear Boxes
- Reducers
- Pumps
- Motors
- Custom Equipment
- Automotive Applications
- Appliances

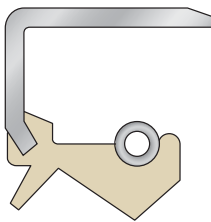

TB

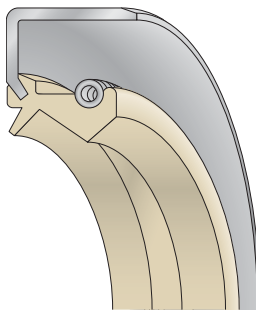

Parker Oil Seal

6

03/28/06



Shaft Recommendations

Material — Parker recommends a shaft material of carbon steel with a minimum hardness of Rockwell C30. Soft materials such as bronze, aluminum or plastic should be avoided because they are susceptible to grooving and will cause premature seal failure. If a soft shaft material must be used, a Parker Quick Sleeve or Parker Wear Sleeve can be installed over the soft shaft material to provide a durable sealing surface. See **Section 7** for details.

Shaft Finish — Parker recommends a plunge ground finish of 8 to 17 $\mu\text{in Ra}$ (0.20 to 0.43 $\mu\text{m Ra}$) with zero lead. Shaft finished significantly smoother or rougher will shorten the service life of the seal. For additional information on shaft finish refer to **Page 2-6**.

Shaft Profile — The shaft profile should include a lead-in chamfer per the following example (see **Table 2-2a** on **Page 2-8**). The leading edge helps prevent lip roll-back and spring dumping. The leading and trailing edges should be free of burrs and sharp edges that could cut the contact point of the seal lip.

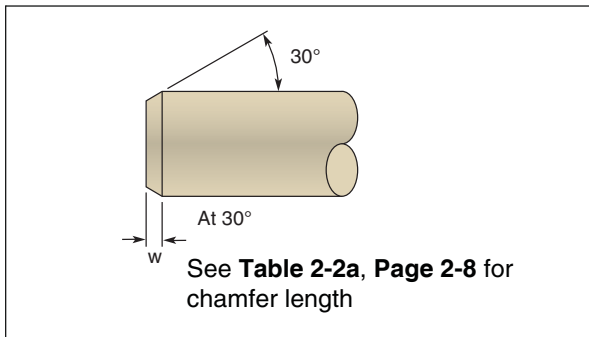

Figure 6-1. Shaft Profile

Shaft Tolerance — To ensure the proper lip-to-shaft interference is maintained, shaft diameters should fall within the tolerances specified in **Tables 6-1, 6-2** and **6-3**. Shafts significantly over the tolerance will increase the underlip temperatures and lead to premature failure. An undersized shaft compromises the amount of lip interference available to maintain a positive seal.

Housing Recommendations

Material — The most commonly used materials for seal housings are steel and cast iron. Care must be taken when softer materials such as aluminum, bronze or plastics are used for the housing material.

Housing Finish — A finish range of 40 to 100 $\mu\text{in Ra}$ (1.0 to 2.5 $\mu\text{m Ra}$) is recommended.

Housing Profile — A lead-in chamfer per the following example is highly recommended for all seal housings. The chamfer aligns the seal during installation and helps prevent the seal from cocking. Both corners of the chamfer should be free of burrs and sharp edges to minimize OD damage.

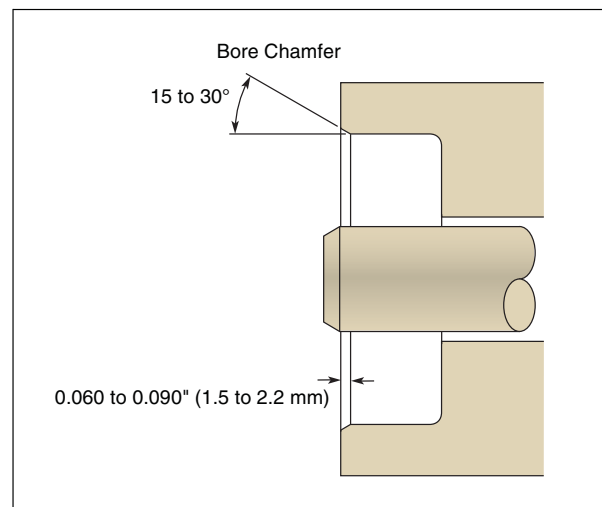

Figure 6-2. Housing Profile

Housing Tolerance — The diametrical tolerance of the housing for Parker Oil Seals should be within the limits specified on the next page.

03/28/06

Table 6-1. Shaft Tolerance

Inch		Metric			
Nominal Shaft Diameter	Shaft Tolerance	Nominal Shaft Diameter	Shaft Tolerance	Nominal Shaft Diameter	Shaft Tolerance
Up to 4.000"	±.003	6 to 10	+0.00 -0.09	250.01 to 315	+0.00 -0.32
		10.01 to 18	+0.00 -0.11	315.01 to 400	+0.00 -0.36
4.001 – 6.000"	±.004	18.01 to 30	+0.00 -0.13	400.01 to 500	+0.00 -0.40
		30.01 to 50	+0.00 -0.16	500.01 to 630	+0.00 -0.44
6.001 – 10.000"	±.005	50.01 to 80	+0.00 -0.19	630.01 to 800	+0.00 -0.50
		80.01 to 120	+0.00 -0.22	800.01 to 1000	+0.00 -0.56
Over 10.000"	±.006	120.01 to 180	+0.00 -0.25	1000.01 to 1250	+0.00 -0.66
		180.01 to 250	+0.00 -0.29	1250.01 to 1600	+0.00 -0.78

Table 6-2. Housing Tolerance for Inches

Nominal Bore Diameter	Bore Tolerance	Metal OD Seal			Rubber Covered OD Seal		
		Seal OD Tolerance	Nominal Press Fit		Seal OD Tolerance	Nominal Press Fit	
			Steel Bore	Aluminum Bore		Steel Bore	Aluminum Bore
Up to 2.000"	±.001"	±.002"	+0.005"	+0.006"	±.003"	+0.008"	+0.009"
2.001 – 3.000"	±.001"	±.0025"	+0.0055"	+0.008"	±.003"	+0.010"	+0.013"
3.001 – 4.000"	±.0015"	±.003"	+0.0065"	+0.010"	±.003"	+0.0105"	+0.014"
4.001 – 5.000"	±.0015"	±.003"	+0.0065"	+0.011"	±.003"	+0.0105"	+0.016"
5.001 – 7.000"	±.0015"	±.003"	+0.007"	+0.014"	±.004"	+0.012"	+0.020"
7.001 – 9.000"	±.002"	±.0035"	+0.0085"	Not Recommended	±.004"	+0.0125"	+0.023"
9.001 – 10.000"	±.002"	±.0035"	+0.0085"	Not Recommended	±.004"	+0.0125"	+0.023"



Table 6-3. Housing Tolerance for Metric

Nominal Bore Diameter	Bore Tolerance	Metal OD Seal		Rubber Covered OD Seal	
		Seal OD Tolerance		Seal OD Tolerance	
		Steel Bore	Aluminum Bore	Steel Bore	Aluminum Bore
Up to 50.00 mm	-0.00 +0.039	+0.20	+0.23	+0.30	+0.33
		+0.08	+0.11	+0.15	+0.18
50.01 – 80.00 mm	-0.00 +0.046	+0.23	+0.32	+0.35	+0.44
		+0.09	+0.18	+0.20	+0.29
80.01 – 120.00 mm	-0.00 +0.054	+0.25	+0.36	+0.35	+0.49
		+0.10	+0.21	+0.20	+0.34
120.01 – 180.00 mm	-0.00 +0.063	+0.28	+0.46	+0.45	+0.65
		+0.12	+0.30	+0.25	+0.45
180.01 – 250.00 mm	-0.00 +0.072	+0.35	Not Recommended	+0.45	+0.72
		+0.15		+0.25	+0.52

03/28/06



Parker Oil Seal Installation

1. Clean seal bore and shaft and remove all burrs and nicks.
2. Pre-lubricate the seal ID and shaft before installing the seal into the cavity. Use a pre-lube that is compatible with the system lubricant. The pre-lube will make the seal easier to install and prevent dry running during initial start-up.
3. Protect seal lip against damage from sharp keyways, splines and screw threads. This can be done by either taping the keyway, inserting an element into the keyway or using an assembly sleeve that fits over the shaft.
4. Point seal lip in correct direction and push to edge of the counterbore.

5. Slide the seal over the shaft to the seal housing. With finger pressure, start seal into housing with a slight rotating motion until seal has a light press fit in the housing. Be sure seal is square or perpendicular to the shaft. If the seal is crooked or cocked, continuing with installation will damage the seal.

6. Finish installation by using a tool appropriate for your seal/housing configuration. Drive seal to final position. If using a plate, the plate diameter should be large enough so it contacts the face of seal housing. This will ensure seal is positioned straight and perpendicular to the shaft.

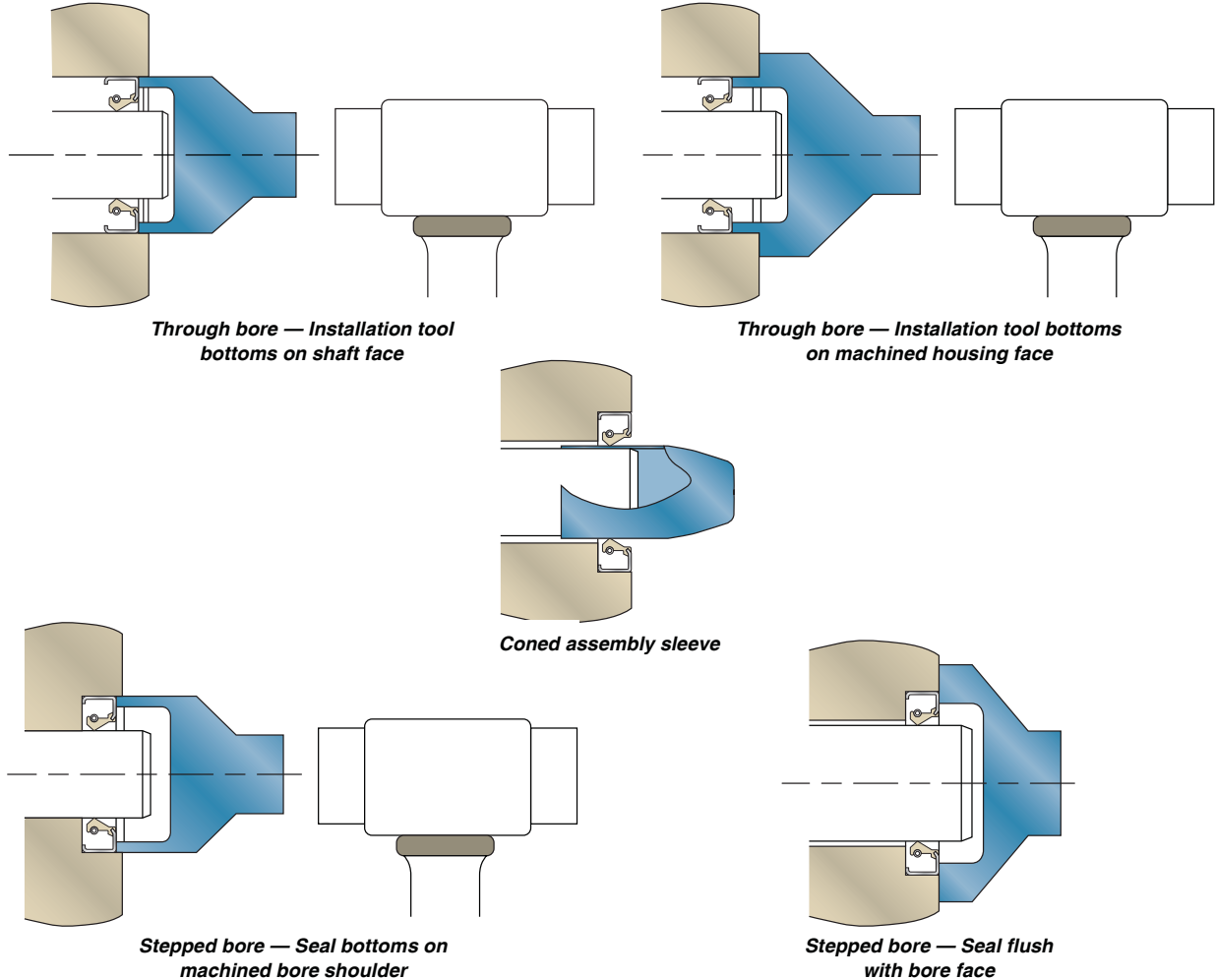

03/28/06

Parker Oil Seals Materials

Catalog EPS 5350/USA

Common Materials Used in this Product

Parker Oil Seals are available in a wide range of materials. The following general material descriptions are for the lip material.

N — Nitrile (NBR)

Standard Nitrile is the most commonly used polymer in the rotary shaft seal industry. NBR has very good resistance to oil, fuel and alkali solutions. Nitrile offers excellent resistance to petroleum-based hydraulic fluids and is resistant to hydrocarbon solvents. Standard Nitrile has poor resistance to ozone, ketones, automotive or aircraft brake fluid, and steam or hot water. Standard Nitrile is recommended for operating in temperatures ranging from -20 to +250 °F (-29 to +121 °C) and offers good mechanical properties and abrasion resistance.

L40, L55 — Low Temp Nitrile (NBR)

Nitrile compounds can be formulated for applications in extreme cold weather environments. These special formulations of Nitrile allow for operation at minimum temperatures ranging down to -70 °F (-57 °C), while maintaining good chemical and abrasion resistance, but the upper temperature limit is lowered to 212 °F (100 °C).

X — Carboxylated Nitrile (XNBR)

XNBR is formulated to greatly enhance tear and abrasion resistance over standard Nitrile, while maintaining similar chemical compatibility. It is used in applications where abrasive materials may collect at the point of shaft contact. XNBR is less resilient and flexible at low temperature, and offers poorer compression set resistance than standard Nitrile. Carboxylated Nitriles are recommended for operation at temperatures ranging from -30 to +250 °F (-34 to +121°C).

H — Hydrogenated Nitrile (HNBR)

Hydrogenated Nitriles offer improved abrasion resistance, excellent chemical resistance and higher operating temperatures than standard NBR. Ozone and weather resistance, as well as resistance to hot water are also increased. HNBR compounds are recommended for operating temperatures ranging from -40 to +300 °F (-40 to +149 °C).

V — Fluoroelastomer (FKM)

FKM provides excellent resistance to oils, fuels and hydraulic fluids at temperatures that far exceed standard Nitrile. It also has very good resistance to flame and excellent impermeability to gases and vapors. FKM is recommended for operating temperatures that range from -40 to +400 °F (-40 to +204 °C).

03/28/06



T — PTFE (T)

Polytetrafluoroethylene is recommended for use with virtually any fluid. Extremely low friction, high temperature tolerance, and dry running capabilities are other advantages of PTFE materials. Excellent mechanical properties are achieved when PTFE is used with fillers such as glass, bronze, carbon fiber, mineral and others. Parker EPS has over 300 compounds to cover virtually all application requirements. Parker can bond PTFE to rubber for enhanced performance.

S — Silicone (VMQ)

Generally recommended for high temperature, low friction applications. Silicone is resistant to weather, ozone, water, bases and alcohols. Not recommended in applications where steam, acids, aliphatic hydrocarbons, aromatic hydrocarbons, halogenated hydrocarbons, phosphate ester or polar solvents are present. It has poor abrasion resistance. Recommended for operating temperatures ranging from -90 to +400 °F (-67 to +204 °C).

C — Neoprene (CR)

Neoprene offers very good resistance to weather, ozone and natural aging as well as good flame resistance while maintaining moderate resistance to oil and gasoline. Good abrasion, flex and cracking resistance is available with the Neoprene material. Neoprene is recommended for operating temperatures ranging from -45 to +250 °F (-43 to +121 °C).

P — Polyacrylate (ACM)

Polyacrylate elastomers are most often recommended for higher operating temperatures or applications where extreme pressure lubricants are used. This material also offers additional resistance over standard Nitrile to ozone and weather attack. Recommended for operating temperatures ranging between -13 to +302 °F (-25 to +150 °C).

E — Ethylene Propylene (EPDM)

EPDM offers excellent heat, ozone and sunlight resistance. EPDM offers very good low temperature flexibility, good resistance to alkalis, acids (such as acetic), and oxygenated solvents (such as MEK). Provides improved resistance to water and steam in applications where NBR and FKM exhibit poor service life. Good replacement for FKM where solvents are a problem. It is not recommended for petroleum oil. EPDM is recommended for operating temperatures of -60 to +300 °F (-51 to +149°C).

EA — Ethylene Acrylic (AEM)

Ethylene Acrylic is generally recommended for low temperature transmission applications. It has good dry running capabilities and good abrasion resistance. Recommended for operating temperatures ranging from -40 to +350 °F (-40 to +177 °C).

03/28/06

Parker Oil Seals





Case Code (B, A, P) — Metal Case

Cold rolled carbon steel is the most common and cost-effective metal case material. Cases are treated to resist corrosion during normal handling and storage. Stainless steel case materials are available at additional cost for use in corrosive applications and extreme conditions. A front chamfer and ParKote™ polymer coating on the OD of the metal case is standard. ParKote™ coating fills small imperfections in the bore. A ground OD is also available.

Case Code (C, M, D) — Rubber Covered

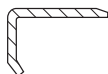
Case material can be partially or completely coated in rubber. Generally, carbon steel cases are used in rubber covered profiles. Rubber covered OD can ease installation and improve bore sealability.

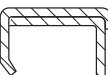
Table 6-4. Case Profiles/Materials

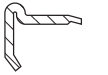
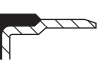
Application	Description	Profile
Most common and economical. ParKote™ coating is standard.	"L" Case	B 
Improved OD sealing in bores with minor imperfections and in soft alloy housings.	Rubber Covered Case	C 
Inner case provides structural rigidity for large cross-sections. ParKote™ coating is standard. Guides shaft during installation.	Double Case	A 
Protects metal case from internal corrosion.	Rubber Lined Case	M 
Ease of removal. Positioning Flange.	"P" Case	P 
Reduced spring back. Ease of installation. Combines sealability of rubber OD and metal retention of metal OD	Heel Case	D 

Spring Materials

Springs are available in a wide range of materials. Parker Oil Seal designs are furnished with carbon steel springs as standard. Other spring materials are available at an additional cost. **Table 6-5** shows general operating parameters for the most common spring materials.

Table 6-5. Spring Material Parameters

Wire Type	Maximum Service Temperature		Application
	°C	°F	
Carbon Steel	120	250	General purpose
Monel 400	230	450	Saltwater
Inconel 750	675	1250	Extreme temperature
Phosphor Bronze	95	200	Saltwater
302/304 Stainless Steel	260	500	Corrosion resistance
316 Stainless Steel	315	600	Hi-temp corrosion resistance
Hastelloy®	315	600	Hi-temp

Table 6-6. Parker Oil Seal Standard Material

Lip Matl. Code	Material Description	Abrasion Resistance	Min. Temp	Cont. Temp	Peak. Temp
N	Nitrile (NBR) Standard NBR offering. The NBR lip material has very good resistance to oil and gasoline. Superior resistance to petroleum based hydraulic fluids. Good resistance to hydrocarbon solvents. Very good resistance to alkalis and solvents. Poor resistance to oxygenated solvents.	Very Good	-20 °F -29 °C	212 °F 100 °C	250 °F 121 °C
X	Carboxylated Nitrile (XNBR) The XNBR lip material is generally tougher and more resistant to tear and abrasion than standard NBR.	Outstanding	-30 °F -34 °C	212 °F 100 °C	250 °F 121 °C
H	Hydrogenated Nitrile (HNBR) The HNBR lip material offers improved abrasion resistance, chemical resistance, higher operating temperature and better ozone resistance than standard NBR.	Outstanding	-40 °F -40 °C	250 °F 121 °C	300 °F 149 °C
L40	Low Temp (NBR) Low temperature Nitrile lip material allows for lower minimum operating temperatures while providing good chemical and abrasion resistance.	Very Good	-40 °F -40 °C	200 °F 93 °C	212 °F 100 °C
L55	Low Temp (NBR) Same characteristics as L40, with lower minimum temperature.	Very Good	-67 °F -55 °C	200 °F 93 °C	212 °F 100 °C
V	Fluoroelastomer (FKM) FKM lip material offers outstanding resistance to high heat. Excellent resistance to oil, gasoline, petroleum hydraulic fluids and hydrocarbon solvents. Very good impermeability to gases and vapors. Very good resistance to flame, weather, oxygen, ozone and sunlight. Very little resistance to oxygenated solvents. Poor tear resistance.	Good	-40 °F -40 °C	325 °F 163 °C	400 °F 204 °C
E	Ethylene Propylene (EPDM) Excellent heat, ozone and sunlight resistance. Very good low temperature flexibility, good resistance to alkalis, acids (such as acetic) and oxygenated solvents (such as MEK). Provides improved resistance to water and steam in applications where NBR and FKM exhibit poor service life. Good replacement for FKM where solvents are a problem. Not recommended for petroleum oil.	Very Good	-60 °F -51 °C	250 °F 121 °C	300 °F 149 °C
S	Silicone (VMQ) Generally recommended for high temperature, low friction applications. Silicone is resistant to weather, ozone, water, bases and alcohols. Not recommended in applications where steam, acids, aliphatic hydrocarbons, aromatic hydrocarbons, halogenated hydrocarbons, phosphate ester or polar solvents are present.	Poor	-90 °F -67 °C	325 °F 163 °C	400 °F 204 °C
CR	Neoprene (CR) Very good resistance to weather, ozone and natural aging as well as good flame resistance while maintaining moderate resistance to oil and gasoline. Good abrasion, flex and cracking resistance is available with the Neoprene material	Very Good	-45 °F -43 °C	212 °F 100 °C	250 °F 121 °C
P	Polyacrylate (ACM) Most often recommended for higher operating temperatures or applications where extreme pressure (EP) lubricants are used. This material also offers additional resistance over standard Nitrile to ozone and weather attack.	Good	-13 °F -25 °C	260 °F 127 °C	302 °F 150 °C
EA	Ethylene Acrylic (AEM) Generally recommended for lower temperature transmission applications. Good dry running capabilities. Good compatibility to ATF fluids. Increased swelling properties over NBR, ACM and FKM.	Good	-40 °F -40 °C	325 °F 163 °C	350 °F 176 °C

03/28/06

Parker Oil Seals Product Offering

Catalog EPS 5350/USA

Part Number Nomenclature — Parker Oil Seals

English

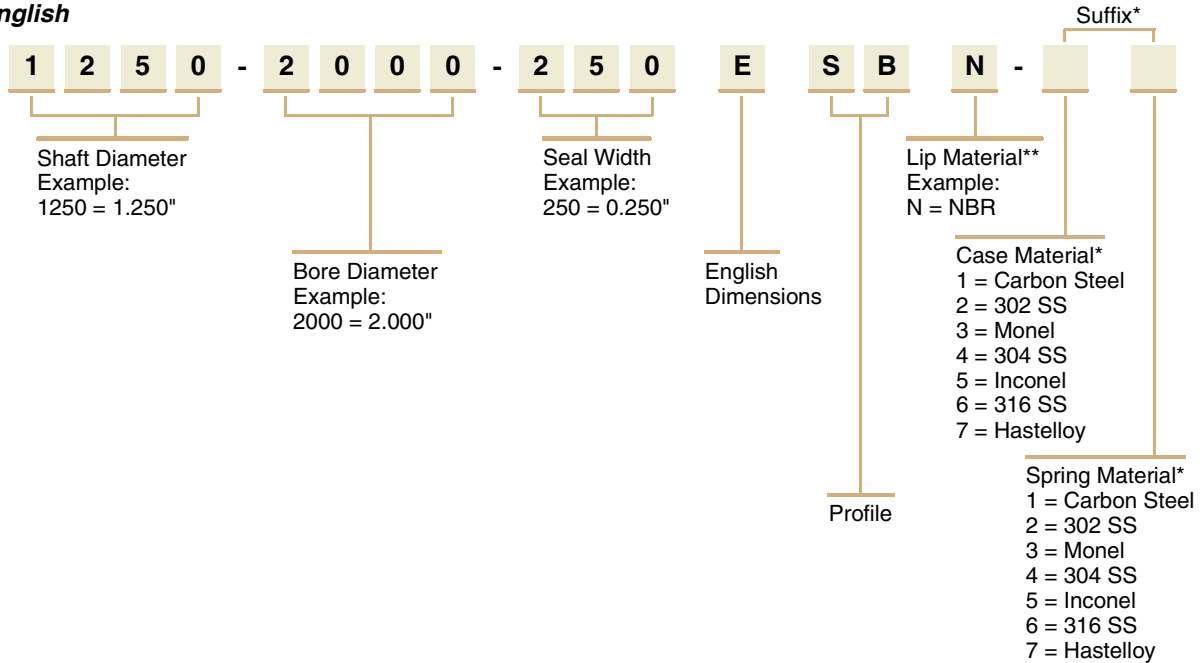

Metric

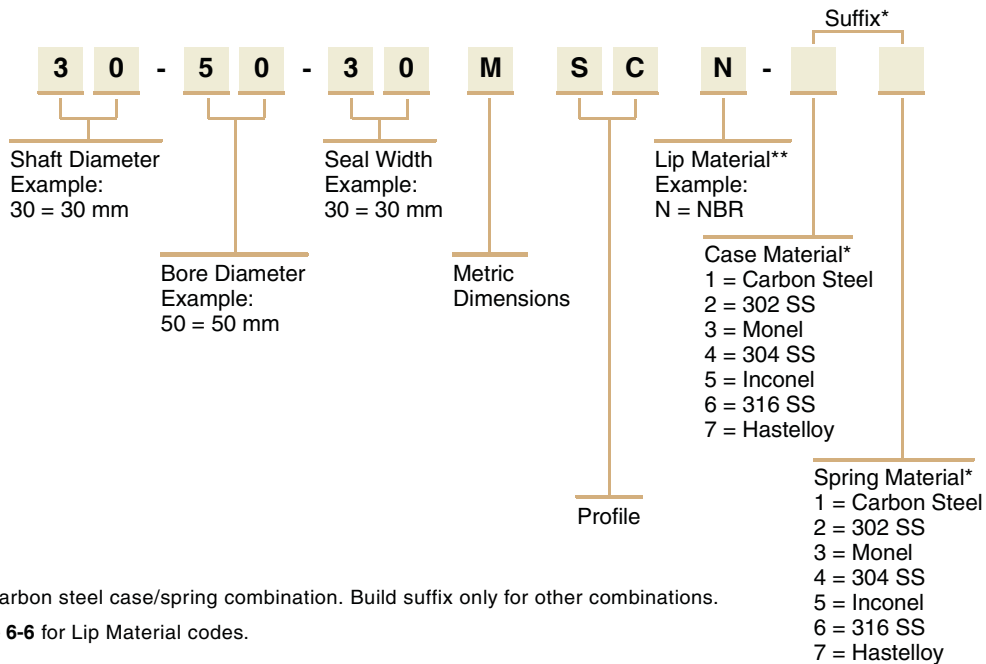

* Blank = Carbon steel case/spring combination. Build suffix only for other combinations.







































** See Table 6-6 for Lip Material codes.

03/28/06



Profiles

Table 6-7. Product Profiles

Standard Profiles	Other Profiles Available				Features	Applications	
SB 	SC 	SA 	SM 	SD 	General purpose. Spring-loaded single lip. For oil retention or grease retention.	Electric motors, gearboxes, pumps, fans and rolling mills.	
TB 	TC 	TA 	TM 	TD 	General purpose. Spring-loaded double lip. For oil retention. Excludes light dust and fluid.	Electric motors, gearboxes, pumps, fans, rolling mills and custom equipment.	
SCE 	SAE 	SME 			Spring-loaded single lip. For oil or grease retention. Low speeds.	High runout conditions. Electric motors, gearboxes, pumps, fans, rolling mills.	
KB 	KC 	KA 	KM 			General purpose. Double lip springless design. For grease retention. Excludes light dust and fluid.	Electric motors, gearboxes, pumps and fans.
VB 	VC 	VA 	VM 			General purpose. Springless single lip. For grease retention.	Electric motors, gearboxes, pumps and fans.
OSB 	OSC 	OSA 			Outside lip design. Spring-loaded single lip. For rotating bores. Press fit on shaft.	Electric motors, gearboxes, pumps and fans. For grease applications where bore rotates.	
W 					General purpose rod wiper. For rotary and reciprocating service. Springless single lip. For dust exclusion.	Low retention, dust exclusion or scraper for reciprocating shafts.	
TDN3 	NSC4 	NTC4 			Pressures to 200 psi (13.7 bar) depending on design. FKM material often used for high temperatures normally associated with friction caused by pressure.	Pumps, washers, compressors and blowers.	
DB 	DC 				Dual spring-loaded lips.	Used when the separation of two fluids is required. The design is also used for high contamination applications in keeping out a dirty environment.	
SBF 	SCF 	TBF 	TCF 			Specially designed seals that utilize a layer of PTFE bonded to the sealing lip to reduce excessive wearing on the shaft and seal.	With the PTFE lip, the seal can be utilized in dry running applications, at higher speeds and accepts a broader range of chemical compatibility.
TN 					The TN lip element is PTFE bonded to NBR and combines the low friction properties of PTFE with the flexibility of rubber.	The TN seal was specially developed for severe service applications.	
CB 	CL (Low Speed) 	CH (High Speed) 			One-piece unitized designs. The sealing elements ride on a proper internal sealing surface which offers the advantage of eliminating the cost of preparing or resurfacing the shaft.	Reducers, gearboxes and torque hubs.	

03/28/06

Operating Temperature Range	Shaft Surface Speed fpm (m/s)	Shaft Size Range Inches (mm)	Maximum Shaft Dynamic Runout (TIR)	Maximum (STBM) Misalignment	Maximum Pressure psi (bar)	Page
NBR -20 °F to 250 °F -29 °C to 121 °C FKM -40 °F to 400 °F -40 °C to 204 °C	Up to 3200 (16.3)	1/4 – 10 (6.4 – 254)	0.010" (0.254 mm)	0.010" (0.254 mm)	0 – 7 (0 – 0.48) <i>Depending on Shaft Speed</i>	6-12
NBR -20 °F to 250 °F -29 °C to 121 °C FKM -40 °F to 400 °F -40 °C to 204 °C	Up to 2500 (12.7)	1/4 – 10 (6.4 – 254)	0.010" (0.254 mm)	0.010" (0.254 mm)	0 – 7 (0 – 0.48) <i>Depending on Shaft Speed</i>	6-12
NBR -20 °F to 250 °F -29 °C to 121 °C FKM -40 °F to 400vF -40 °C to 204 °C	Up to 2500 (12.7) <i>Speed Depends on Runout</i>	3/4 – 10 (19 – 254)	0.020" – 0.125" (0.51 – 3.18 mm)	0.020 – 0.125" (0.51 – 3.18 mm)	0 – 3 (0 – 0.20) <i>Depending on Shaft Speed</i>	6-17
NBR -20 °F to 250 °F -29 °C to 121 °C FKM -40 °F to 400 °F -40 °C to 204 °C	Up to 2000 (10.2)	1/4 – 10 (6.4 – 254)	0.010" (0.254 mm)	0.010" (0.254 mm)	0 – 7 (0 – 0.48) <i>Depending on Shaft Speed</i>	6-13
NBR -20 °F to 250 °F -29 °C to 121 °C FKM -40 °F to 400 °F -40 °C to 204 °C	Up to 2000 (10.2)	1/4 – 6 (6.4 – 152)	0.010" (0.254 mm)	0.010" (0.254 mm)	0 – 7 (0 – 0.48) <i>Depending on Shaft Speed</i>	6-13
NBR -20 °F to 250 °F -29 °C to 121 °C FKM -40 °F to 400 °F -40 °C to 204 °C	Up to 1000 (5.1)	1/4 – 10 (6.4 – 254)	0.010" (0.254 mm)	0.010" (0.254 mm)	0 – 7 (0 – 0.48) <i>Depending on Shaft Speed</i>	6-18
NBR -20 °F to 250 °F -29 °C to 121 °C FKM -40 °F to 400 °F -40 °C to 204 °C	Rotary: Up to 2000 (10.2) Reciprocating: Up to 300 (1.5)	3/8 – 10 (9.5 – 254)	0.010" (0.254 mm)	0.008" (0.20 mm)	0	6-20
NBR -20 °F to 250 °F -29 °C to 121 °C FKM -40 °F to 400 °F -40 °C to 204 °C	Up to 4000 (20.3)	1/4 – 4 (6.4 – 102)	0.005" (0.127 mm)	0.005" (0.127 mm)	200 (13.7) <i>Depending on Shaft Speed</i>	6-15
NBR -20 °F to 250 °F -29 °C to 121 °C FKM -40 °F to 400 °F -40 °C to 204 °C	Up to 2000 (10.2)	1/4 – 4 (6.4 – 102)	0.010" (0.254 mm)	0.010" (0.254 mm)	0 – 7 (0 – 0.48) <i>Depending on Shaft Speed</i>	6-14
NBR -20 °F to 250 °F -29 °C to 121 °C FKM -40 °F to 400 °F -40 °C to 204 °C	Up to 5000 (25.4)	1/2 – 10 (12.7 – 254)	0.010" (0.254 mm)	0.010" (0.254 mm)	0 – 7 (0 – 0.48) <i>Depending on Shaft Speed</i>	6-19
NBR -20 °F to 250 °F -29 °C to 121 °C FKM -40 °F to 400 °F -40 °C to 204 °C	Up to 2500 (12.7)	3/8 – 6 (9.5 – 152)	0.006" (0.152 mm)	0.010" (0.254 mm)	0 – 10 (0.68) <i>Depending on Shaft Speed</i>	6-19
NBR -20 °F to 250 °F -29 °C to 121 °C FKM -40 °F to 400 °F -40 °C to 204 °C	Up to 3200 (16.3)	1/2 – 14 (12.7 – 356)	0.010" (0.254 mm)	0.010" (0.254 mm)	0 – 7 (0 – 0.48) <i>Depending on Shaft Speed</i>	6-16



03/28/06



Parker Oil Seals

Spring-Loaded Oil Retention Profiles

Catalog EPS 5350/USA

Spring-Loaded Oil Retention Profiles

TB, SB — Metal case with ParKote™ bore sealant or ground OD. Most common and economical.

TC, SC — Rubber covered OD for improved OD sealing and soft alloy housing.

TA, SA — Double case with ParKote™ bore sealant or ground OD. Structural rigidity, blind shaft installation.

Application

General purpose, spring-loaded design. Most commonly used for oil or grease retention. Double lip profiles have secondary lip for light dust and fluid exclusion.

Technical Data

Operating Temperature Range

NBR: -20 to 250 °F (-29 to 121 °C)
FKM: -40 to 400 °F (-40 to 204 °C)

Shaft Surface Speed

TB, TC, TA — Up to 2500 fpm (12.7 m/s)
SB, SC, SA — Up to 3200 fpm (16.3 m/s)

Maximum Pressure

0 to 7 psi (0 to 0.48 bar), depending on shaft speed

Shaft Size Range

0.250 to 10.000 inches (5 to 260 mm)

Important: For full listings of standard sizes, see **Appendices B and C**.

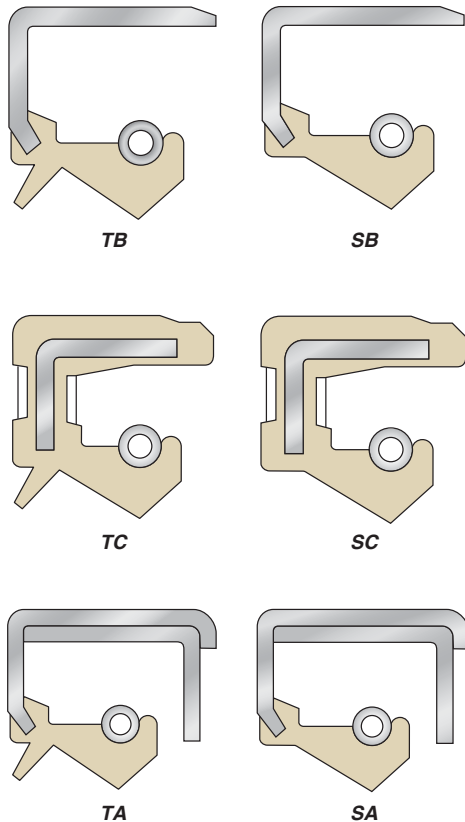

For additional case profiles/materials options, see **Page 6-7**.

03/28/06

Parker Oil Seals

Springless Grease Retention Profiles

Catalog EPS 5350/USA

Springless Grease Retention Profiles

KB, VB — Metal case with ParKote™ bore sealant or ground OD. Most common and economical.

KC, VC — Rubber covered OD. Improved OD sealing and soft alloy housing.

KA, VA — Double case with ParKote™ bore sealant or ground OD. Structural rigidity, blind shaft installation.

Application

General purpose, springless design. Most commonly used for grease retention. Double lip profiles incorporate a secondary lip for exclusion of light dust and fluids.

Technical Data

Operating Temperature Range

NBR: -20 to 250 °F (-29 to 121 °C)
FKM: -40 to 400 °F (-40 to 204 °C)

Shaft Surface Speed

Up to 2000 fpm (10.2 m/s)

Maximum Pressure

0 to 7 psi (0 to 0.48 bar), depending on shaft speed

Shaft Size Range

0.250 to 6.000 inches (5 to 150 mm)

Important: For full listings of standard sizes, see **Appendices B and C**.

6

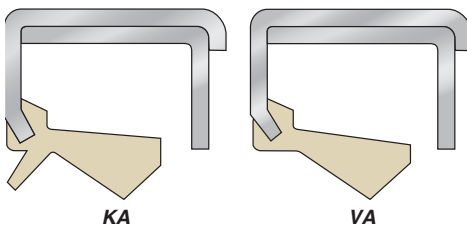
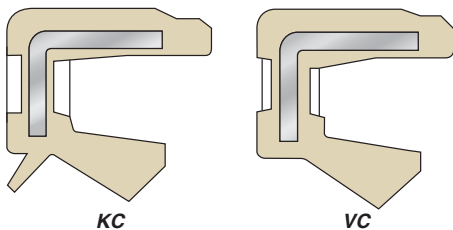
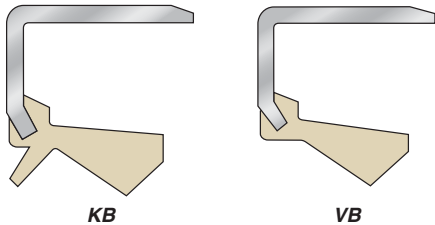

For additional case profiles/materials options, see **Page 6-7**.

03/28/06

Parker Oil Seals

Dual Spring-Loaded Lip Profiles

Catalog EPS 5350/USA

Dual Spring-Loaded Lip Profiles

DB — Metal case with ParKote™ bore sealant or ground OD. Most common and economical.

DC — Rubber covered OD for improved OD sealing and soft alloy housing.

DA — Assembled case with ParKote™ bore sealant or ground OD. Structural rigidity, blind shaft installation.

Application

Dual spring-loaded lips are generally used where separation of two fluids is required. Also used for high contamination applications.

Technical Data

Operating Temperature Range

NBR: -20 to 250 °F (-29 to 121 °C)

FKM: -40 to 400 °F (-40 to 204 °C)

Shaft Surface Speed

Up to 2000 fpm (10.2 m/s)

Maximum Pressure

0 to 7 psi (0 to 0.48 bar), depending on shaft speed

Shaft Size Range

0.250 to 4.000 inches (5 to 100 mm)

Important: Contact customer service for available sizes.

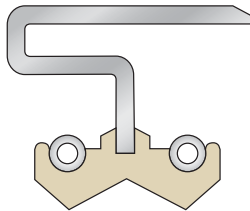

DB

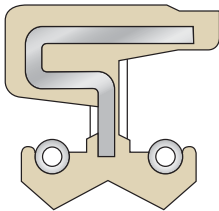

DC

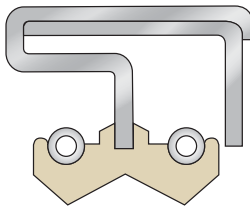

DA

6

03/28/06

Parker Oil Seals

Medium Pressure Profiles

Catalog EPS 5350/USA

Medium Pressure Profiles

TDN3 — Rubber covered OD for improved OD sealing and secondary lip for light dust exclusion.

NSC4 — Rubber covered OD for improved OD sealing.

NTC4 — Rubber covered OD for improved OD sealing and secondary lip for light dust exclusion.

Application

For medium pressure applications.

Technical Data

Operating Temperature Range

NBR: -20F to 250 °F (-29 to 121 °C)

FKM: -40 to 400 °F (-40 to 204 °C)

Shaft Surface Speed

Thru 4000 fpm (20.3 m/s)

Maximum Pressure

Up to 200 psi (13.7 bar), depending on design and shaft speed

Shaft Size Range

0.250 to 4.000 inches (5 to 100 mm)

Important: Contact customer service for available sizes.

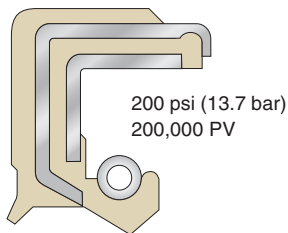

200 psi (13.7 bar)
200,000 PV

TDN3

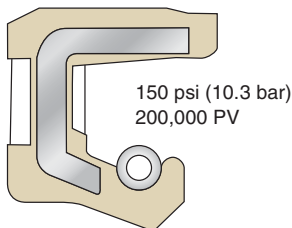

150 psi (10.3 bar)
200,000 PV

NSC4

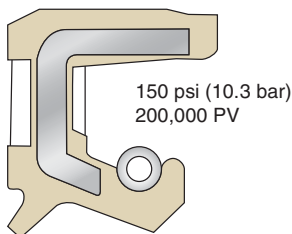

150 psi (10.3 bar)
200,000 PV

NTC4

6

03/28/06

Parker Oil Seals Cassette Profiles

Catalog EPS 5350/USA

6

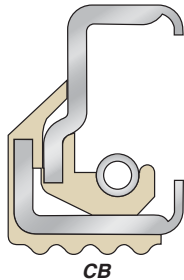

CB

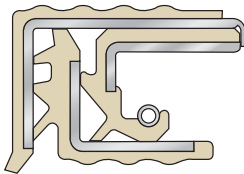

CL
(Low Speed)

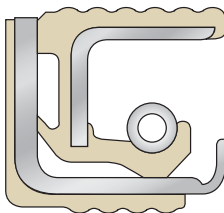

CH
(High Speed)

Cassette Profiles

CB — Metal case with ParKote™ bore sealant standard. CB design requires special installation tool.

CL, CH — Rubber covered OD for improved OD sealing and soft alloy housing.

Application

Unitized design. Sealing elements ride on a proper internal sealing surface. Primarily used in gear box applications. Improved contaminant exclusion. Minimizes shaft surfacing requirements and will not groove shaft.

Technical Data

Operating Temperature Range

NBR: -20 to 250 °F (-29 to 121 °C)

FKM: -40 to 400 °F (-40 to 204 °C)

Shaft Surface Speed

Up to 3200 fpm (16.3 m/s) depending on design

Maximum Pressure

0 to 7 psi (0 to 0.48 bar), depending on shaft speed

Shaft Size Range

0.500 to 14.000 inches (10 to 350 mm)

Important: Contact customer service for available sizes.

03/28/06

Parker Oil Seals

High Eccentricity Single Lip Profiles

Catalog EPS 5350/USA

High Eccentricity Single Lip Profiles

SCE — Rubber covered OD for improved OD sealing in bores with minor imperfections and soft alloy housing.

SME — Metal case OD with rubber inside providing corrosion protection for inside of case.

SAE — Double case with ParKote™ bore sealant standard. Inner case provides structural rigidity for large cross-sections. Guides shaft during installation.

Application

Seal lip floats with shaft for more uniform lip loading during misalignment conditions. High runout conditions, up to 0.125 inch (3.18 mm) total eccentricity for oil or grease retention. Moderate speeds, dependent on misalignment.

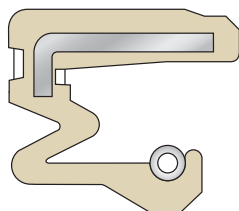

SCE

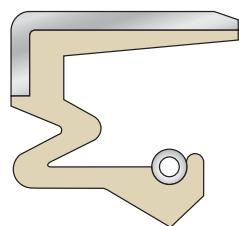

SME

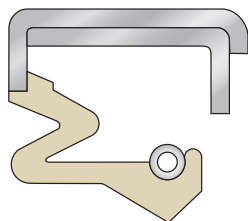

SAE

Technical Data

Operating Temperature Range

NBR: -20 to 250 °F (-29 to 121 °C)
FKM: -40 to 400 °F (-40 to 204 °C)

Shaft Surface Speed

Up to 2500 fpm (12.7 m/s) depending on runout

Maximum Pressure

0 to 3 psi (0.20 bar), depending on shaft speed

Shaft Size Range

0.750 to 10.000 inches (20 to 260 mm)

Important: Contact customer service for available sizes.

6

03/28/06

Parker Oil Seals

Rotating Bore Profiles

Catalog EPS 5350/USA

Rotating Bore Profiles

OSB — Metal case with press fit ID.

OSC — Rubber covered ID for improved ID sealing.

OSA — Double case for structural rigidity.

Application

Outside spring-loaded single lip design. For grease applications where bore rotates.

Technical Data

Operating Temperature Range

NBR: -20 to 250 °F (-29 to 121 °C)

FKM: -40 to 400 °F (-40 to 204 °C)

Surface Speed

Up to 1000 fpm (5.1 m/s)

Maximum Pressure

0 to 7 psi (0 to 0.48 bar), depending on speed

Shaft Size Range

0.250 to 10.000 inches (5 to 260 mm)

Important: Contact customer service for available sizes.

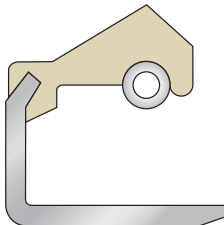

OSB

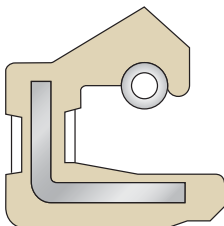

OSC

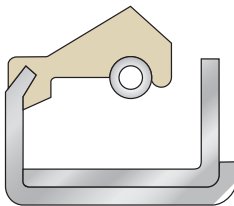

OSA

6

03/28/06

Parker Oil Seals

PTFE/Elastomer Profiles

Catalog EPS 5350/USA

PTFE/Elastomer Profiles

SBF — Metal case with ParKote™ bore sealant standard. Most common and economical.

SCF — Rubber covered OD for improved OD sealing in bores with minor imperfections and soft alloy housing.

TBF — Metal case with ParKote™ bore sealant standard. Most common and economical.

TCF — Rubber covered OD for improved OD sealing in bores with minor imperfections and soft alloy housing.

TN — The TN lip element is PTFE bonded to NBR and combines the low friction properties of PTFE with the flexibility of rubber.

Application

The lip element is PTFE bonded to rubber and combines the low friction properties of PTFE with the flexibility of rubber. For dry running applications, higher speeds and enhanced chemical compatibility.

Technical Data

Operating Temperature Range

NBR: -20 to 250 °F (-29 to 121 °C)
FKM: -40 to 400 °F (-40 to 204 °C)

Shaft Surface Speed

Up to 5000 fpm (25.4 m/s)
(TN — up to 2500 fpm [12.7 m/s])

Maximum Pressure

0 to 7 psi (0 to 0.48 bar), depending on shaft speed
(TN — up to 10 psi [0.68 bar])

Shaft Size Range

0.500 to 10.000 inches (10 to 250 mm)

Important: Contact customer service for available sizes.

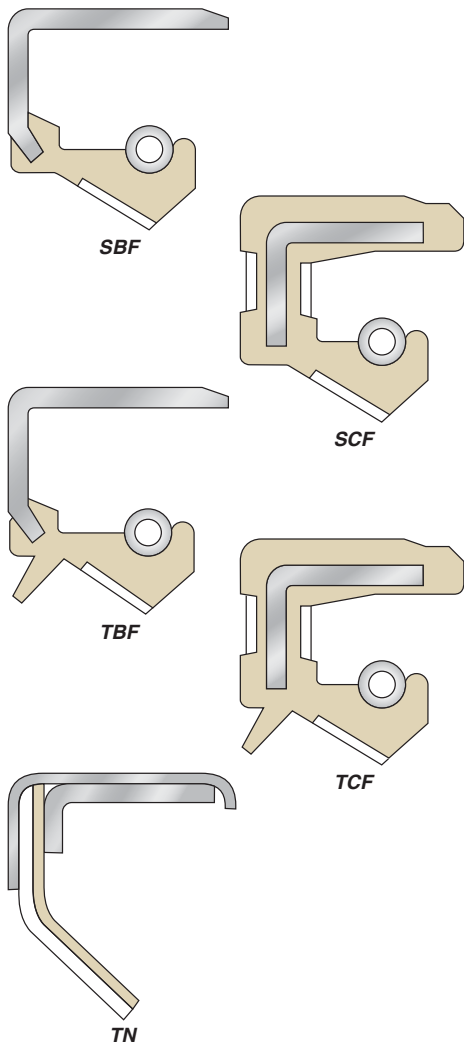

6

03/28/06

Parker Oil Seals

Wiper and Scraper Profiles

Catalog EPS 5350/USA

Wiper and Scraper Profiles

W — Metal case with ParKote™ bore sealant or ground OD. Scraper lip profile.

WPC — Rubber covered OD for improved OD sealing. Wiper profile for grease retention in slow rotary and reciprocating applications.

WPR — Rubber covered OD for improved OD sealing. Scraper lip profile.

Application

General purpose rod wiper. For rotary and reciprocating shafts. Single lip, springless design. For heavy dust exclusion.

Technical Data

Operating Temperature Range

NBR: -20 to 250 °F (-29 to 121 °C)

FKM: -40 to 400 °F (-40 to 204 °C)

Shaft Surface Speed

Up to 2000 fpm (10.2 m/s) Rotary

Up to 300 fpm (1.5 m/s) Reciprocating

Maximum Pressure

0

Shaft Size Range

0.375 to 10.000 inches (10 to 250 mm)

Important: Contact customer service for available sizes.

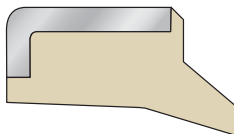

W

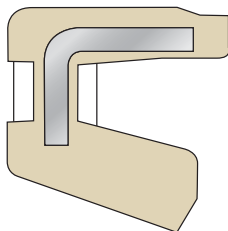

WPC

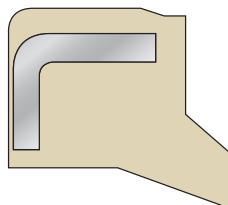

WPR

6

03/28/06

Shaft Sleeves Introduction

Catalog EPS 5350/USA

Contents

Engineering	7-2
Materials	7-3
Product Offering	7-4



Shafts can become damaged by contaminants or excessive wear under the seal lip. The use of Parker shaft sleeves can prevent damage or provide an alternative to expensive repairs.

The Parker Quick Sleeve is an ultra-thin, chrome-plated stainless steel sleeve for shafts up to 7 inches (178 mm) in diameter. The low profile of the Quick Sleeve eliminates the need for a change in seal size. It has a removable flange to accommodate a variety of seal configurations and comes with an installation tool.

The Parker wear sleeve is a metal ring which is press fit on the shaft to provide a uniform sealing surface. It is most often constructed of carbon steel with a special phosphate coating in a flanged or non-flanged design. Replacement seal ID must be sized to match the installed wear sleeve OD.



Sealing Systems

Wear Sleeve

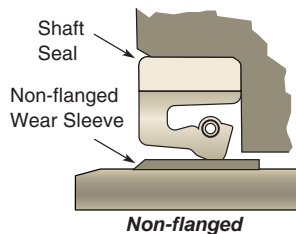
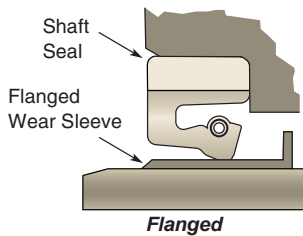

Quick Sleeve

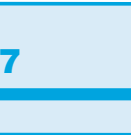
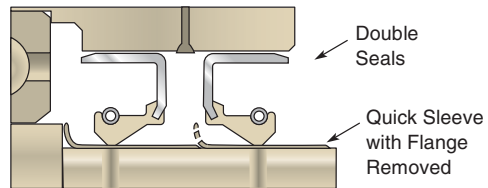
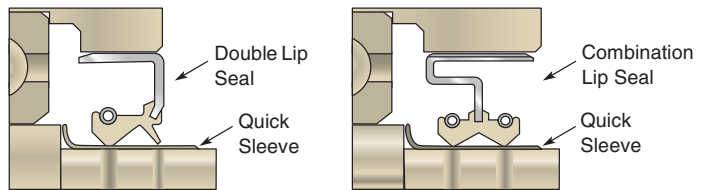

03/28/06



Shaft Sleeves Engineering

Catalog EPS 5350/USA

Design Engineering

Quick Sleeve

A shaft can become grooved by a sealing lip and ultimately create a leak path due to excessive dirt, water, high shaft speed or heat. The Quick Sleeve is a cost effective alternative to repairing or replacing a severely damaged shaft. It provides a new proper sealing surface, is easy to install and does not require excessive equipment downtime.

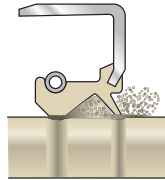

Wear Sleeve

The use of a Parker Wear Sleeve:

- Eliminates refinishing of shafts in the field — saving machining costs and equipment downtime.
- Eliminates costly finishing of new shafts — saving on machining, grinding and polishing normally required to provide an adequate sealing surface.

Design Options

Wear sleeve design options include:

- Stamped sleeves with phosphate coating.
- Machined sleeves without phosphate coating, ground to 10 to 25 Ra finish.

Shaft Finish

Shaft finishes up to 100 Ra require little or no sealant under the Parker Wear Sleeve. Damaged or grooved shafts or finishes greater than 100 Ra require a thin coat of sealant under the wear sleeve.

Installation

Quick Sleeve

To select the correct size Quick Sleeve, measure the diameter of the shaft at three positions just ahead of the wear path. Average the readings to compensate for an out-of-round shaft. Find your average diameter in the Quick Sleeve size listing. Sufficient press-fit is designed into the sleeve when this diameter falls within a range on the size listing. See **Appendix E**.

The Quick Sleeve is designed with a removable flange to accommodate a variety of seal configurations. To remove flange, cut through flange to the score line using cutting pliers. Install sleeve. Fold flange back and forth to start clean break along score line.

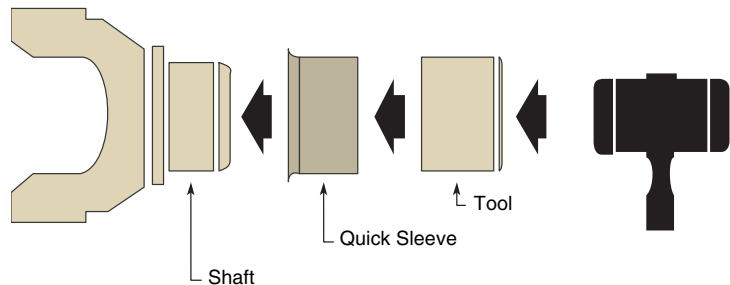

Quick Sleeve Installation

Wear Sleeve

1. Remove all dirt, burrs or old adhesive from the shaft area where the wear sleeve will be seated.
2. If the shaft is scored or its finish is rougher than 100 RMS, apply a thin coat of gasket cement.
3. Position wear sleeve over shaft and press into position using sleeve tool or flat plate. Light hammer blows against sleeve tool or flat plate are sufficient to seat wear sleeve. Some users prefer to expand the wear sleeve by mildly heating (not to exceed 400 °F [204 °C]) and then quickly slip it into position on the shaft.
4. Clean OD of wear sleeve, making sure that all gasket cement has been removed. Gasket cement is highly abrasive and could cause seal leakage.
5. Apply light coat of system compatible lubricant to wear sleeve OD.

03/28/06



Shaft Sleeves Materials

Catalog EPS 5350/USA

Common Materials Used in this Product

Quick Sleeves are constructed of chrome-plated stainless steel.

Parker Wear Sleeves are generally constructed of carbon steel with a special phosphate coating. Custom metals are available.

Stainless Steel

Good chemical and corrosion resistance properties.

Carbon Steel

Good in oils and other media friendly to ferrous metals. Can be finished with a phosphate coating that helps hold rust inhibitors on the surface of the sleeve. Also available without phosphate coating, ground to a 10 to 25 RMS finish with a rust inhibitor. Excellent value for cost-sensitive projects.

Chrome Plated Stainless Steel

The hard chrome finish provides an extremely durable, corrosion free sealing surface covering the chemically resistant stainless steel substrate.



7

03/28/06



7-3

www.parkerseals.com

Parker Hannifin Corporation
EPS Division
Toll Free: (800) 233-3900



Shaft Sleeves

Product Offering

Catalog EPS 5350/USA

Profiles

Table 7-1. Product Profiles

Style	Features	Applications
Quick Sleeve 	0.010" (0.25 mm) ultra thin hard chrome plate. Fits shafts up to 7" in diameter. Removable flange.	For grooved or unfinished shafts.
WS — Wear Sleeve, Flanged 	Provides uniform sealing surface. Flanged design. Phosphate coated or machined finish.	For grooved or unfinished shafts.
WS — Wear Sleeve, Non-flanged 	Provides uniform sealing surface. Non-flanged design. Phosphate coated or machined finish.	For grooved or unfinished shafts.

Important: For size listing see **Appendix E**.

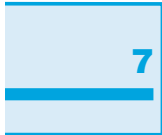

03/28/06



7-4

Parker Hannifin Corporation
EPS Division

Toll Free: (800) 233-3900

www.parkerseals.com

ProTech™ Bearing Isolators

Introduction

Catalog EPS 5350/USA

Contents

Engineering	8-5
Materials	8-14
Product Offering	8-18
Part Numbering	
Nomenclature	8-18
ProTech Bearing Isolators	
LS Profile	8-22
LN Profile	8-23
LB, SB Profiles	8-24
LW Profile	8-25
WD Profile	8-26
SL Profile	8-27
SM Profile	8-28
ML Profile	8-29
MN Profile	8-30
FS-360 Profile	8-31
FN-360 Profile	8-32



Parker developed the unique ProTech design to provide unmatched two-way sealing for zero lubricant leakage and total exclusion of contaminants. This is accomplished by using non-contact labyrinth seal technology. ProTech features the most effective labyrinth design for both dirt exclusion and oil retention and is far superior to isolators that rely on internal O-rings or other internal seals for sealability. If you want more than just an O-ring for bearing protection — step up to ProTech!



ProTech Bearing Isolator

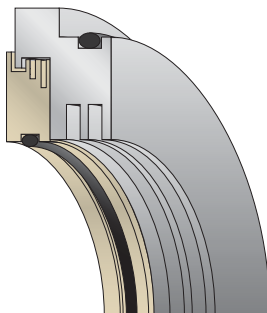

LS Profile

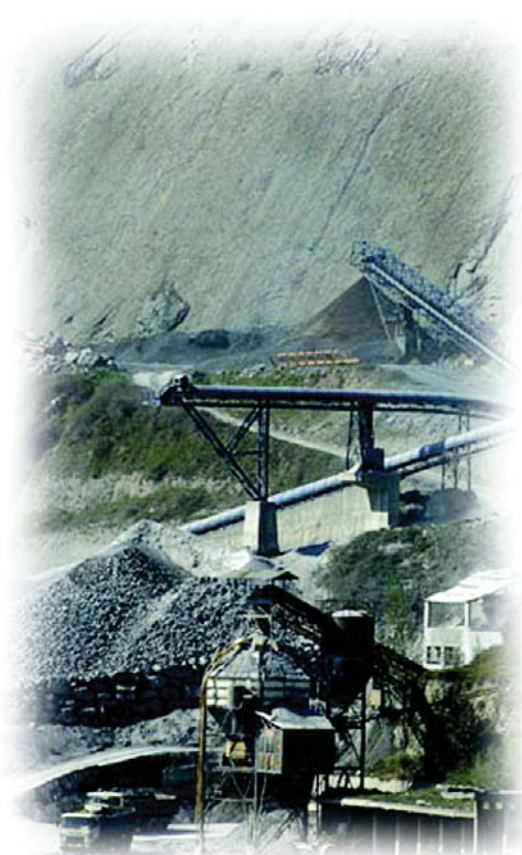

8

03/28/06



Applications

Chemical Resistance Applications

Advanced proprietary PTFE compounds mean ProTech is well suited for caustic environments such as citric acids found in juice processing and strong sulfides in pulp and paper processing. ProTech's superior chemical resistance allows for the standardization of a single material within a plant, eliminating the need to stock duplicate sizes in expensive stainless steel, Hastelloy® or other exotic materials. PTFE is compatible with over 160 chemicals vs. 11 for bronze and 30 for stainless steel.



Food Processing Applications

ProTech's unique designs and superior performance are "eating the competition's lunch" in the food processing market. The WD is an economical profile for high volume, disposable equipment such as wash down grade motors and drives. It also greatly reduces maintenance costs and downtime in food processing applications such as picker hubs in poultry processing. Anti-microbial and FDA materials are readily available.



Pumps, Motors and Gearbox Applications

The isolator protection you rely on for protecting bearings in pumps and motors is also available for gearbox applications. ProTech 360 is a hybrid design that incorporates an outboard labyrinth for contaminant exclusion and PTFE lip technology for positive oil retention, even in vertical down applications. ProTech 360 is used by numerous OEMs for their most demanding gearbox applications.



Quality Commitment

ProTech is manufactured under strict quality control processes — from raw material selection to finished product. The highest quality and absolute consistency from lot-to-lot are assured by:

- Our many years of seal manufacturing experience
- Use of only first-grade virgin PTFE resins
- Sophisticated system for controlling critical sintering process
- Specialized CNC production equipment
- QS-9000 certification



03/28/06



Features and Benefits

Table 8-1. Features and Benefits

Features	Benefits
Non-contact Design	<ul style="list-style-type: none"> • Virtually no torque consumption • Will not wear or groove shafts
Two-Piece Unitized Construction	<ul style="list-style-type: none"> • Complete exclusion of dust and water • Zero oil leakage • Fewer components and ease of installation
Accommodates Greatest Axial Movement in Industry	<ul style="list-style-type: none"> • Reduces a major factor causing labyrinth seal leakage
Fluoroelastomer O-Rings	<ul style="list-style-type: none"> • Static elastomer seal for the most severe services
No Lubrication Required	<ul style="list-style-type: none"> • Can run dry because of non-contact design
High Shaft Speeds	<ul style="list-style-type: none"> • Operates far beyond shaft speed limits of standard radial lip seals • Liberal specifications for shaft and bore finish result in low shaft cost
Precision-Machined Seal	<ul style="list-style-type: none"> • Allows retrofit of most bore and shaft combinations • No tooling charges

Product Selection Guide

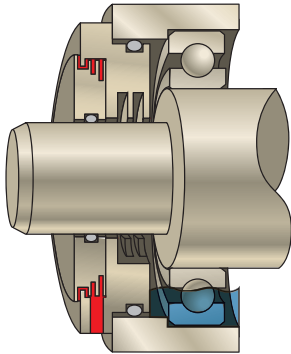
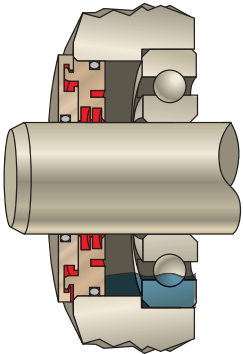
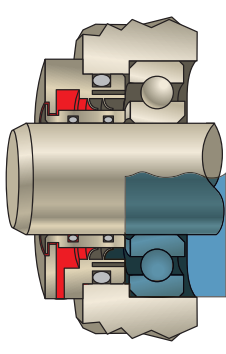
ProTech	Millennium	Protech 360
		
<p>ProTech features the most effective labyrinth design for both dirt exclusion and oil retention and is far superior to isolators that rely on internal O-rings or other internal seals for sealability.</p>	<p>The Millennium profile is the first and only metallic isolator that is unitized without internal O-rings or locking rings. Millennium's patented labyrinth technology does not rely on a simple O-ring for bearing protection.</p>	<p>The ProTech 360 profile is the first and only hybrid isolator designed for flooded oil and oil mist applications. Used by numerous gearbox OEMs as standard equipment, the ProTech 360 features internal dual PTFE lips on an internal stainless steel sleeve for zero shaft wear.</p>



03/28/06



Sealing System

Parker's ProTech design innovations include the first bearing isolator with a two-piece unitized design, complete wrap-around rotor, severe splash oil grooves and a hybrid isolator for flooded applications.

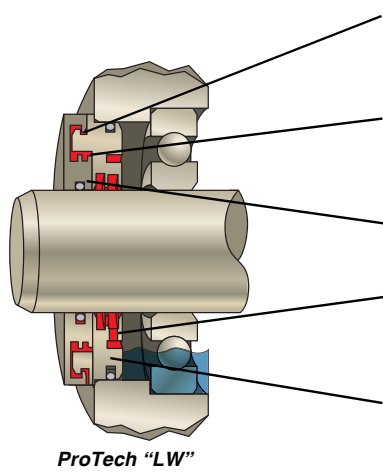

ProTech "LW"

- First to offer two-piece unitized construction. Patented design locks seal together and won't wear like internal O-rings, PTFE elements or other locking rings.
- Contaminant exclusion relies on labyrinth technology, not an internal seal. ProTech does not rely on a simple internal O-ring to protect your bearings.
- Superior chemical resistance provided by proprietary PTFE materials.
- Setting the standard for oil retention. Inboard labyrinth is the most efficient design for retaining oil splash. Far superior to the single groove concept.
- External O-rings provide press fit at shaft and seal housing for zero wear of shaft and housing. Also allows for easy installation.

First isolator U.L. tested to IEEE 841, meets IP55, IP56, IP66, IP69k and API 610.

Table 8-2. IEEE IP Ratings

First Numeral	Protection Against Foreign Objects (Dust)	Second Numeral	Protection Against Water
0	None	0	None
1	Solid objects > 50 mm (large)	1	Vertically falling drip water
2	Solid objects > 12.5 mm (medium)	2	Vertically falling drip water tipped up to 15° from its normal position
3	Solid objects > 2.5 mm (small)	3	Atomized water
4	Solid objects > 1 mm (grain-type)	4	Spray water
5	Dust protected	5	Hose-directed water
6	Dust-proof	6	Strong water jets
		7	Dipped in water
		8	Submerged in water
		9k	High pressure water spray (1160 to 2320 psi [80 to 160 bar]) from spray nozzle located 4 inches (102 mm) away from seal



03/28/06



ProTech™ Bearing Isolators Engineering

Catalog EPS 5350/USA

Troubleshooting

The time to reduce or eliminate seal failure is before it happens. In many instances, factors beyond the seal manufacturer's control determine the seal's performance. The following check lists will help identify possible causes of seal failure and suggest remedies.



*Failed Seal Resulting from
Improper Fit*



*Failed Seal Resulting from
Improper Installation*

Application Check List

1. Is the correct size seal being utilized?
2. Is the most suitable seal profile being utilized?
3. Are the service media and the temperature compatible with the seal material?
4. Are the equipment conditions, such as the shaft to bore misalignment, shaft finish, and bore finish within recommended limits?
5. Do any unusual equipment variables exist which might affect overall seal performance?

Installation Check List

1. Has the seal been damaged in storage or handling?
2. Have the O-rings been properly lubricated prior to installation?
3. Have the O-rings been damaged by passing over sharp keyway, splines, threads or burrs?
4. Have the O-rings "rolled" or "twisted"?
5. Has the seal been installed perpendicular to the bore and shaft centerline?
6. Has an adequate vent been provided to relieve all internal pressure?
7. Has adequate drainage been provided to prevent excessive oil build-up over the bottom of the shaft?
8. Have you verified whether a false flooded condition exists?

8

03/28/06



Table 8-3. Troubleshooting Guide

Trouble Sign	Possible Source	Suggested Remedy
Seal OD Leakage	Housing bore too rough, pitted, severe corrosion, grooved, etc.	Improve finish to recommended limits. (See Page 8-13 .)
	Insufficient OD O-ring fit	Measure bore diameter, compare to nominal required dimensions of equipment and seal requirements.
	Seal OD O-ring damaged during installation	Protect O-ring from all sharp burrs at leading edge of bore. A chamfer should be used on leading edges. Lubricate O-rings prior to installation. (See Page 8-12 .) Care should also be used when storing the seal for future usage.
	Seal OD O-ring damaged from chemical incompatibility	Consult chemical compatibility chart in Appendix H . (FKM is the standard ProTech O-ring material unless specified otherwise.)
Seal ID Leakage	Shaft surface too rough — pitted, severe corrosion, grooved, etc.	Improve finish to recommended limits. (See Page 8-13 .)
	Insufficient ID O-ring fit	Verify shaft diameter, compare to nominal required dimensions of equipment and seal requirements. Verify nominal seal dimensions match actual shaft diameter.
	Seal ID O-ring damaged during installation	Protect O-ring from all sharp burrs at leading edge of shaft. A chamfer should be used on leading edges. (See Page 8-12 .) Care should also be used when storing the seal. To prevent cutting, protect ID O-rings from shaft keyways, splines, etc. Use proper installation tools to prevent seal O-ring damage.
	Seal ID O-ring damaged from chemical incompatibility	Consult chemical compatibility chart in Appendix H . (FKM is the standard ProTech O-ring material unless specified otherwise.)
Seal Leakage from Drain Port	Internal pressure present	Vent housing if possible. If vented, verify breather or pressure limiting device is functioning correctly. Up to 5 psi, upgrade seal design to ProTech 360.
	ProTech 360 only, internal pressure > 5 psi	Vent housing if possible. If vented, verify breather or pressure limiting device is functioning correctly.
	Internal seal failure	Contact Parker Application Engineering.
Seal Leakage from between Rotor and Stator	Oil level too high	Lower oil level. Ensure internal oil drains are adequate. Upgrade seal design to ProTech 360.
	Internal pressure present	Vent housing if possible. If vented, verify breather or pressure limiting device is functioning correctly. Up to 5 psi, upgrade seal design to ProTech 360.
	ProTech 360 only, internal pressure > 5 psi	Vent housing if possible. If vented, verify breather or pressure limiting device is functioning correctly.
	Internal seal failure	Contact Parker Application Engineering.

8

03/28/06



ProTech™ Bearing Isolators

Design Engineering

The important considerations in selecting a bearing isolator are:

- For best oil splash retention, avoid designs that use simple inboard oil grooves.
- For long term performance, select a design that does not rely on an internal seal such as an O-ring, V-ring or other internal component to achieve sealability.
- For best contaminant exclusion, select a seal that is purposely designed to control laminar flow.
- Avoid designs that require special installation tools. The easier the seal is to install, the less chance seal damage will occur during installation.
- Select a material that will not introduce harmful dusting into the bearing cavity.

Further Considerations

- Determine what impact upgrading to a bearing isolator will have on the total cost of sealing based on return on investment (ROI).
- Standardize on a material that provides the broadest chemical compatibility throughout your facility.
- Avoid designs that are sold on features that are not scientifically sound.
- Select a manufacturer that has extensive knowledge in the science of sealing and is an industry leader in design innovation.
- Ask the manufacturer for documented copies of test results for IP55, IP56, IP66 and IP69k that have been conducted by third parties (such as U.L.) in order to verify performance claims.

Upgrading to Bearing Isolators

The cost of downtime in today's manufacturing environment has been the primary driver behind the decision of companies to convert key equipment such as pumps, motors, gear boxes and split pillow block bearings from a standard lip seal to a bearing isolator type seal.

While the initial cost of a lip seal is much lower than a bearing isolator, the total cost of the sealing system over the life of the equipment should be evaluated as part of the decision-making process. Bearing isolators are able to extend the Mean Time Between Failure (MTBF) because true non-contact isolators will never wear out as compared to standard lip seals that have a typical life of 3,000 to 5,000 hours. Bearing isolators permanently exclude contaminants, which means the seal is no longer the limiting factor for the bearing approaching the L10 life rating stated by the bearing manufacturer. The primary cost savings are a result of fewer rebuilds and less unplanned downtime over the life of the equipment. Additional savings result from lower torque consumption meaning less energy consumption and lower maintenance costs. Energy savings alone can offset the costs of the upgrade.

Once the decision has been made to upgrade to bearing isolators, the next step is to select a bearing isolator design. The two basic design types are contact and non-contact. The contact design relies on an internal seal for excluding contaminants while the non-contact design relies on labyrinth technology and provides zero wearing components. ProTech Bearing Isolators are non-contact.

The ProTech bearing isolator consists of two components, a rotor and a stator.

Stator

An external O-ring at the ProTech stator OD maintains a press fit in the seal housing and provides a static seal for oil retention. Because this is a static seal, it will not wear out over time.

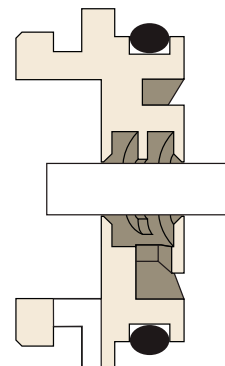

ProTech Stator



03/28/06

The O-ring press fit allows for easy seal installation while also providing excellent bore retention. The press fit will withstand a torque of up to 500 in-ounces (36,000 g-cm) to eliminate spinning in the housing. The press fit has been tested in the vertical down position to ensure the stator will not walk out of the seal bore.

The stator has a sophisticated series of grooves to retain oil splash. Before ProTech, bearing isolators relied on a single inboard groove for oil retention. Results from independent testing by a major pump OEM showed Parker's design to be the most effective for oil retention when compared to various competitor designs.

Rotor

The second component, the rotor, uses an external O-ring to maintain a static press fit on the shaft. Since the rotor spins with the shaft, it will not wear, groove or damage the shaft, so the costs associated with having to recondition the sealing surface of the shaft are eliminated. The wrap-around profile of the ProTech rotor provides optimal water exclusion.

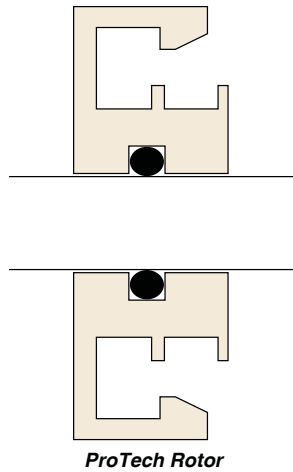

The rotor and stator are assembled at the Parker factory where they are permanently unitized by means of a patented process. The unitized design allows for one-piece installation and maintains a minimal clearance between the rotor and stator interface for the life of the seal. This interface is the first line of defense against contamination. A unitized design maintains the seal's integrity by keeping high-pressure water spray, vibration or axial movement from separating or increasing the gap between the rotor and stator.

Controlling Laminar Flow

ProTech relies on true non-contact labyrinth seal technology. When the rotor and stator are assembled at our factory, a true non-contact labyrinth is created. For successful water

exclusion, the labyrinth must control the laminar flow properties of the liquid entering the seal. Laminar is the flow of a liquid in an organized layered manner, or as the name suggests laminates. A liquid flowing through a pipe has various flow levels ranging from zero at the outer wall to a maximum along the centerline.

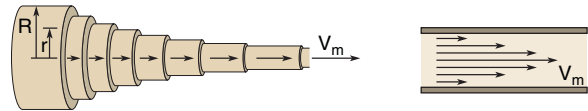

Typical Laminar Flow Pattern

Introduction of Turbulence

An effective seal design must introduce turbulence into the flow. Turbulence slows down the rate of flow of the liquid so that gravity alone is enough to expel the liquid through the seal drain port. The left side of **Figure 8-1** depicts the faster moving laminar flow. The arrows show how the individual water molecules line up in even planes. The right side shows that while laminar flow is still present close to the seal wall, most of the fluid is a slower moving turbulent flow. The direction change, pressure differential, plus the friction of the molecules themselves, aid in slowing the rate of flow.

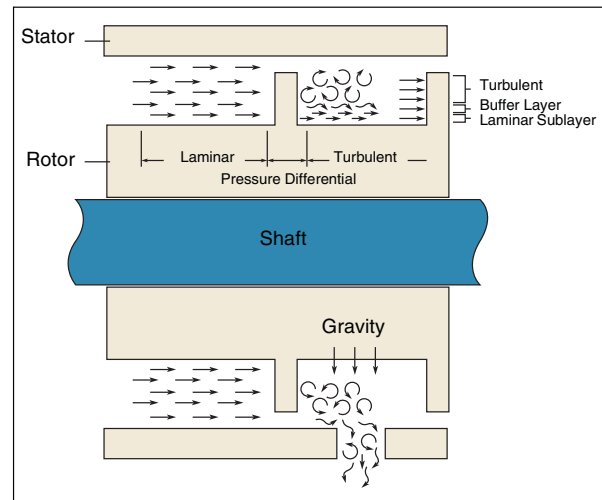
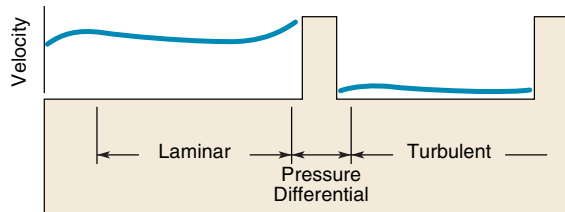

Figure 8-1. Effects of Turbulence



ProTech™ Bearing Isolators



Introduction of Turbulence Reduces the Rate of Flow

ProTech’s effectiveness is due to the number of times turbulence is introduced to the flow through either forcing a change in direction or dropping the pressure that is pushing the fluid, by using pressure differential chambers. As fluid passes from a smaller restriction to a larger restriction, it undergoes a significant pressure drop. With a decrease in the energy pushing the fluid, the velocity of the fluid will also decrease. ProTech forces any fluid that enters the seal through 11 different directions and 4 pressure differential chambers.

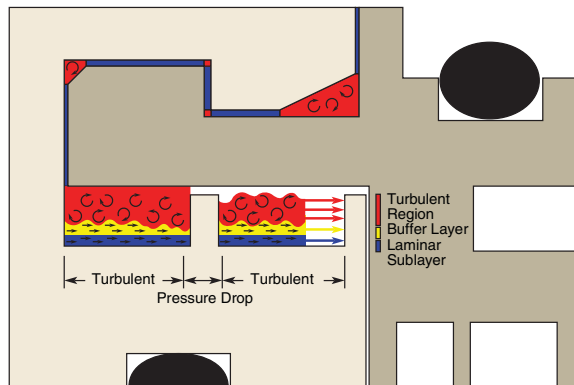

Pressure Drops and Turbulence

Extra care must be taken during the design process to avoid introducing features that will contribute to laminar flow. Designs that rely on directional changes alone and use smooth wall channels tend to take out previously introduced turbulence and convert the flow back to laminar. Such designs are easy to spot because they must incorporate an internal component, typically an O-ring, in an attempt to match ProTech’s performance.

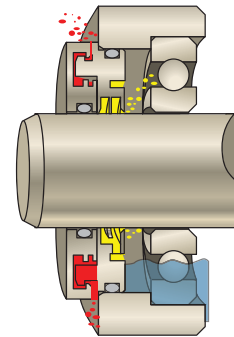

Flow Patterns

The graphic shows the flow pattern of contaminants in red. The lubricant flow pattern is in yellow.

A brand new seal that incorporates an internal O-ring may do very well in performance testing. However, the internal seal is a contacting seal that will wear over time. Testing indicates that leakage will occur in less than 400 hours of run time. The internal seal acts as a dam that is holding back a pool of contaminants. As soon as there is a break in the contact, due to wear or the slightest axial movement, the pooled contaminants will flood into the bearing housing. The internal seal is also very susceptible to severe wear from abrasive contaminants. Sludge deposits also make the internal seal inoperable. Designs which rely on internal seals are incapable of excluding even mild water spray if the internal seal is removed.

Depicted below are some of the common designs that are available today and they can be defined by the unitization method that is used.

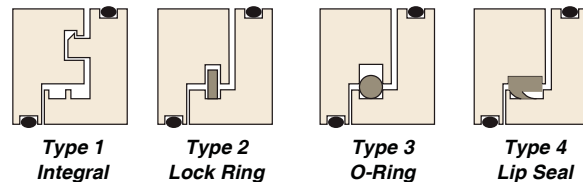

Parker’s ProTech is modeled after the Type 1 unitization method which is integrally unitized and a true non-contact design. There are no internal components to wear or damage the seal. Because there are no internal components to wear, performance will not diminish over time.

Type 2 uses an internal locking ring to unitize the seal. It is typically a ring made from nylon or other plastic material.



03/28/06



Types 3 and 4 use internal locking rings with a dual purpose. Not only do they unitize the seal, they also provide the majority of the sealing function. Type 3 uses an internal O-ring and Type 4 uses a contact lip seal made of PTFE. If you remove these internal components, the designs will not function. As these components wear, the seal performance will diminish over time. Internal seals have a limited life due to wear caused by axial shaft movement and chemical attack. Over time the operating temperature will harden the internal seal, making it less effective.

The purpose of internal components can also be negated by contamination. The photo at right shows an internal O-ring that is locked into a groove by contamination, completely negating its intended purpose. Abrasive contaminants will also cause severe wearing of internal components.

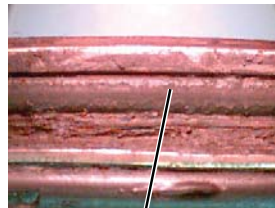

Internal Compromised O-Ring

Because internal seals are not precision balanced components, they can oscillate or wobble at speed. This can create an action that pumps contamination into the bearing housing. The photo at right shows a stream of water being pumped directly into the bearing cavity by a bearing isolator design that uses an internal O-ring as the primary seal.

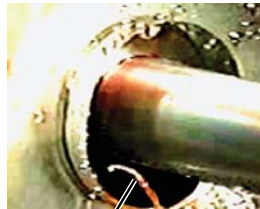

Water Being Pumped into the Bearing Cavity

Parker's ProTech line of bearing isolators feature a true non-contact design (Type 1) and do not rely on an internal O-ring as the primary seal. Additional internal seals simply are not needed with a proper labyrinth design.

Materials

Material is also an important consideration. ProTech uses advanced proprietary PTFE compounds making it well suited for harsh environments such as citric acids found in juice processing and strong caustics such as sulfides in pulp and paper processing. ProTech's superior chemical resistance allows for the standardization of a single material within a plant, eliminating the need to stock duplicate sizes in expensive stainless steel, Hastelloy® or other exotic materials. Standard chemical compatibility charts recommend PTFE for 160 chemicals versus 11 for bronze and 30 for stainless steel.

ProTech and a leading metallic isolator were soaked in sulfuric acid. After 30 days the metallic isolator was heavily corroded, the O-rings had disintegrated and the rotor and stator were locked together.



ProTech vs. metallic isolator after soaking 30 days in acid

ProTech showed zero signs of any harmful effects and could be installed in an application with no performance issues. The temperature range for standard material is -40 to +250°F (-40 to +121 °C). Higher temperature applications can be handled with alternate materials.

Another important material consideration is the result of initial seal break-in. During initial start-up, it is very common to have slight contact between the rotor and stator. This is a result of the axial shaft movement that occurs as the equipment reaches operating speed. The axial movement at operating speed can force the seal's stator and rotor into contact with each other. The contact will create a dusting of the seal material until a sufficient amount of material has been removed so that the rotor and stator are no longer wearing against each other. The primary concern is this material will find its way into the bearing cavity. With a metallic material, the bearing is contaminated with a dust that has a detrimental effect on bearing life. With ProTech, the dusting is a fine PTFE material, free of glass and other abrasive fillers, that does not have any harmful effects on bearing life or performance. It can be argued that PTFE actually enhances lubrication.

03/03/06



ProTech™ Bearing Isolators

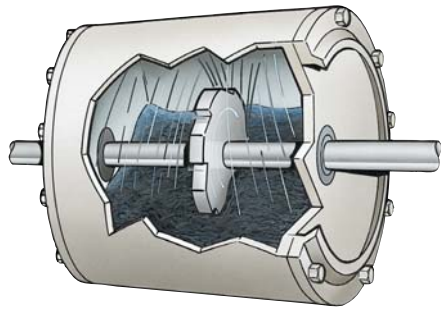

Oil Leakage Test

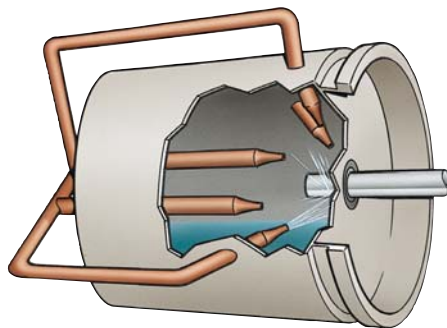

Water Exclusion Test



Dust Exclusion Test

Testing and Validation

Laboratory testing has significant advantages over field testing. The lab effectively compresses time and more easily explores limits. Before ProTech saw its first field test, it was put through laboratory tests far more severe than conditions ever encountered in the field. ProTech’s effectiveness is also validated by independent laboratory testing.

Both ProTech and competitive seals were subjected to three extreme in-house tests with ProTech clearly emerging as the seal of choice.

1. Oil Leakage Test

ProTech and other seals were subjected to critical oil seal testing using a machine built to SAE J110 standards. One-hundred hour tests were conducted with severe oil splash.

2. Water Exclusion Test

The test machine was modified by mounting five nozzles at various positions relative to the exterior of the seal to simulate severe external wash down. Using water at pressures of 30 to 62 psi (2.0 to 4.3 bar), these nozzles individually sprayed each seal from a distance of 3" in both a static mode and while the shaft rotated at various speeds up to 3525 RPM. The nozzles tried to force water past the seal for nearly two hours.

3. Dust Exclusion Test

The test machine was modified with an enclosed chamber containing a large quantity of fine dust and sand which was vigorously agitated with the chamber attached to the outside of each seal area. The equipment operated at speeds up to 3525 RPM for a period of 70 hours in an environment that was literally a dense dust storm.

Conclusions

ProTech was the only seal that passed all three torture tests. In addition to lab testing, field trials confirm ProTech’s performance superiority.



Table 8-4. Extreme Test Results

Material: Expulsion Method: Design Type: Brand	PTFE Single-Port 2-Pc. Unitized Parker	Bronze Single-Port 2-Pc. Non-Unitized Brand A	PTFE Multi-Port 3-Pc. Unitized Brand B	Bronze Single-Port 3-Pc. Unitized Brand C
Oil Leak Test	PASS	Fail	Pass	Fail
Water Pressure Test	PASS	Fail	Fail	Fail
Dust Test	PASS	Pass	Fail	Fail

03/03/06



Installation

Standard Design Installation

The ProTech seal is unitized; any attempt to disassemble the seal will damage it. After making any adjustments to the equipment, confirm that the seal is still properly installed.

Prior to Installation

1. **Warning!** Disconnect all system power, and follow all standard safety procedures.
2. Remove all sharp edges from the following:
 - a. Lead-in chamfers
 - b. Keyway
 - c. Splines
 - d. Snap ring grooves
3. Clean all foreign debris from bore and shaft areas.

Installation

1. Lubricate bore and shaft O-rings with system-compatible lubricant.
2. Position the seal over the shaft by hand. Seal position is correct if the stator O-ring is towards the seal housing as shown.
3. Slide seal down the shaft, stopping just before the seal housing of the equipment. Use hand pressure only.
4. Rotate the seal so that the drain port is centered at the six o'clock position. Press seal into bore using hand pressure only. If necessary, gently tap seal into bore using a soft-faced tool.
DO NOT USE A METALLIC HAMMER OR PUNCH as this may damage the seal.



Position the Seal



Installing the Seal

Split Seal Installation

Prior to Installation

1. **Warning!** Disconnect all system power and follow all standard safety procedures.
2. Remove sharp edges on the shaft and bore where the seal will be installed. Make sure there are proper lead-in edges.
3. Clean all foreign debris from the bore and shaft area.

Installation

1. Pre-lubricate the O-rings with a system-compatible lubricant.
2. Position the shorter O-ring on the shaft and place the two halves of the rotor, with the flange sides facing away from the bore, over the O-ring so the O-ring fits into the groove (see Fig. 8-2). (It might help to first paste the O-ring to the shaft with a light coat of grease.) Then place the screws in the rotor halves and screw the two halves together loosely. Do not tighten the screws.

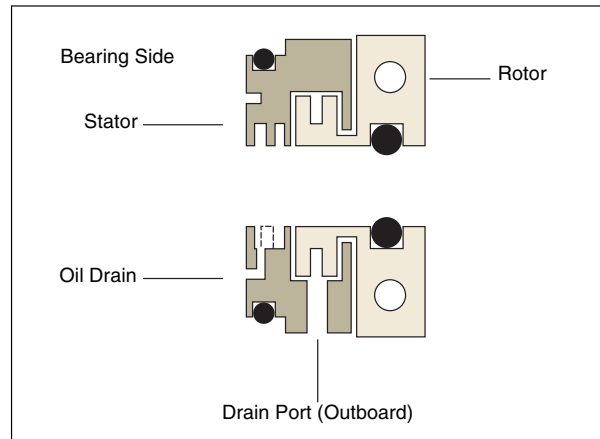

Figure 8-2. Position the Rotor Halves



03/28/06



ProTech™ Bearing Isolators

3. Place the two halves of the stator over the rotor at the bore side so they interlock with the rotor. Rotate the stator until the drain port is at the six o'clock position. While holding the parts together by hand, wrap the long O-ring into the stator O-ring groove with the ends of the O-ring meeting at the 12 o'clock position. Gently slide the seal into the bore while keeping the O-ring in the groove (see **Fig. 8-3**).

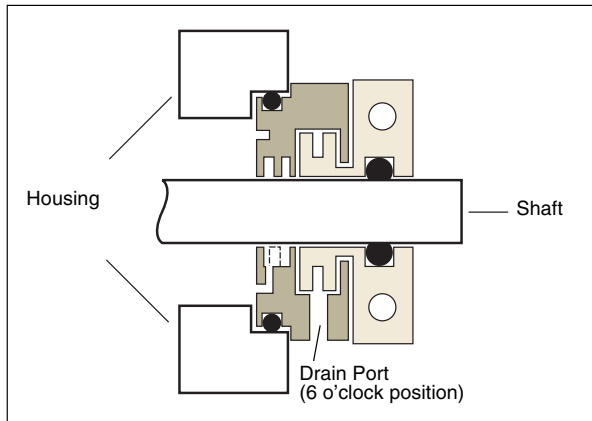

Figure 8-3. Proper Installation

4. Gently tighten the screws; stopping a few times to make sure that the shaft can turn freely. Tighten the screws so the halves of the rotor meet. Do not turn the screws more than one eighth turn beyond where the halves meet. **DO NOT OVER-TIGHTEN THE SCREWS.**

After making any adjustments to the equipment, confirm that the seal is still properly installed.

Hardware Considerations

The design of ProTech and Millennium bearing isolators use the compression of O-rings to maintain a press fit of the rotor to the shaft and the stator to the bore. This ensures there is no relative motion or wear between the seal and housing components.

Due to lack of dynamic sealing surface, finish conditions are not as critical as they would be with a rotary lip seal.

The most common material for shafts is steel. For seal bores common materials are steel, cast iron and aluminum. ProTech and Millennium may be used with a broader range of materials, such as non-ferrous metals and plastics, that meet the application needs.

Bores

No special heat treat is required.

Surface finish of 32 µin Ra (0.81 µm Ra) is preferred but 64 µin Ra (1.6 µm Ra) in many cases can be tolerated.

Lead-in chamfer is required — 0.032 to 0.063" (0.81 to 1.6 mm) x 30° with no sharp edges.

Shafts

No special heat treat is required.

Surface finish of 32 µin Ra (0.81 µm Ra) is preferred but 64 µin Ra (1.6 µm Ra) in many cases can be tolerated.

Shaft lead is not an issue, so ground finish is not required.

Total eccentricity including runout or whip is 0.020" (0.51 mm) T.I.R. for most standard designs. The ProTech 360 design can handle up to 0.003" (0.08 mm). Special designs can tolerate much more.

Table 8-5. Tolerances

Shaft Tolerance	
Shaft Speeds — fpm (m/s)	Under 5000 (25)
Shaft Diameters — Inches (mm)	All Diameters
LSE, LSM, LNE, LNM, LME, LMM, LWE, LWM, LXE, LXM, LDE, LDM, LBE, LBM, SLE, SLM, WDE, WDM, MLE, MLM, MNE, MNM, FSE, FSM, FNE, FNM	± .002 (0.05)
Bore Tolerance	
Cavity Bore Diameter — Inches (mm)	All Diameters
LSE, LSM, LNE, LNM, LME, LMM, LWE, LWM, LXE, LXM, LDE, LDM, LBE, LBM, SLE, SLM, WDE, WDM, MLE, MLM, MNE, MNM, FSE, FSM, FNE, FNM	± .002 (0.05)



ProTech™ Bearing Isolators Materials

Catalog EPS 5350/USA

Unmatched Corrosion Resistance

Advanced proprietary PTFE compounds mean ProTech is well suited for caustic environments such as citric acids found in juice processing and strong sulfides in pulp and paper processing.



ProTech's superior chemical resistance allows for the standardization of a single material within a plant, eliminating the need to stock duplicate sizes in expensive stainless steel, Hastelloy or other exotic materials. PTFE is compatible with over 160 chemicals vs. 11 for bronze and 30 for stainless steel.



*Metallic Millennium
Bearing Isolator*

Seal Materials

PTFE Materials

-1 — 20210 Proprietary Graphite Filled PTFE

Graphite filled PTFE, offers low wear, low coefficient of friction, a superior material for dynamic applications.

-2 — 20999 Food Grade (FDA) Mineral Filled PTFE

Mineral filled PTFE that meets FDA requirements to achieve improved wear and longer life. White in color.

-5 — 20113 Proprietary Graphite Filled PTFE

Proprietary filled PTFE, offers low wear and exceptional thermal stability. Used in larger diameters where bore retention is critical.

-7 — 20995 Anti Microbial PTFE

Proprietary filled PTFE that meets FDA requirements approved for dairy contact, offers superior wear characteristics that exceed other materials used in dynamic food and drug processing equipment applications. White in color. Material contains anti microbial additive that prevents growth of bacteria.

-8 — 20990 FDA 3A PTFE

Mineral filled PTFE that meets FDA requirements to achieve: improved wear, longer life and FDA clearance. White in color. Meets 3A sanitary standards for USDA food and dairy product contact.

Metallic

-B — Bronze C93200 (SAE 660)

The most popular bronze bearing material, SAE 660, is particularly suited for medium to relatively high speeds. SAE 660 provides good hardness, strength and wear resistance; excellent anti-frictional qualities and good conformability. Excellent machining properties.

03/28/06



-S — 304 Stainless Steel

Corrosion Resistance: Excellent... exceeding that of Type 302 in a wide variety of corrosive media including hot petroleum products, steam combustion gasses. Frequently used in the food and beverage industry which requires a high degree of sanitation and cleanliness.

316 Stainless Steel

Corrosion Resistance: Good resistance to a wider range of chemicals than Type 304. Highly resistant to the complex sulphur compounds used in pulp and paper processing. Also resists attack of marine and corrosive industrial atmospheres. This type is also highly resistant to pitting and withstands corrosive actions of acids, dyes, and salts used in the process, textile and pulp industries. Applications include the manufacture of pumps, valves, textile and chemical equipment.

Carbon Steel

Corrosion resistance: Poor with no corrosion treatment. Minimum physical properties of 36,000 psi yield strength and 58,000 psi tensile strength. Applications include a wide variety of industrial equipment.

Table 8-6. Standard Seal Material Temperature Range

Matl. Code	Material	Min. Temp	Cont. Temp.	Peak Temp.
-1	20210 Proprietary Graphite Filled PTFE	-40 °F	250 °F	250 °F
		-40 °C	121 °C	121 °C
-2	20999 (Food Grade FDA) Mineral Filled PTFE	-40 °F	250 °F	250 °F
		-40 °C	121 °C	121 °C
-5	20113 Proprietary Graphite Filled PTFE	-40 °F	250 °F	250 °F
		-40 °C	121 °C	121 °C
-7	20995 Anti Microbial PTFE	-40 °F	250 °F	250 °F
		-40 °C	121 °C	121 °C
-8	20990 FDA 3A PTFE	-40 °F	250 °F	250 °F
		-40 °C	121 °C	121 °C
-B	Bronze C93200 (SAE 660)	-40 °F	400 °F	400 °F
		-40 °C	204 °C	204 °C
-S	304 Stainless Steel	-40 °F	400 °F	400 °F
		-40 °C	204 °C	204 °C
Special	316 Stainless Steel	-40 °F	400 °F	400 °F
		-40 °C	204 °C	204 °C
Special	Carbon Steel	-40 °F	400 °F	400 °F
		-40 °C	204 °C	204 °C

Note: Other materials and custom compounding available. Contact Parker for more information.



03/28/06



O-Ring Materials

-1 — Fluorocarbon (FKM)

Fluorocarbon (FKM) has excellent resistance to high temperatures, ozone, oxygen, mineral oil, synthetic hydraulic fluids, fuels, aromatics and many organic solvents and chemicals. Special FKM compounds exhibit an improved resistance to acids, fuels, water and steam.

-2 — Fluorosilicone (FVMQ)

FVMQ contains trifluoropropyl groups next to the methyl groups. The mechanical and physical properties are very similar to VMQ. However, FVMQ offers improved fuel and mineral oil resistance but poor hot air resistance when compared with VMQ.

-3 — Acrylonitrile-Butadiene (NBR)

Nitrile rubber (NBR) is the general term for acrylonitrile butadiene terpolymer. Higher acrylonite content NBR has better resistance to oil and fuel, good mechanical properties and high wear resistance. Lower acrylonite content NBR has better elasticity and resistance to compression set, weathering and ozone.

-4 — Tetrafluoroethylene-Propylene (AFLAS®)

This elastomer is a copolymer of tetrafluoroethylene (TFE) and propylene. Its chemical resistance is excellent across a wide range of aggressive media.

-5 — Ethylene Propylene Rubber (EPM, EPDM)

EPM is a copolymer of ethylene and propylene. Ethylenepropylene-diene rubber (EPDM) is produced using a third monomer and is particularly useful when sealing phosphate-ester hydraulic fluids and in brake systems that use fluids having a glycol base.

-6 — Silicone Rubber (Q, MQ, VMQ, PVMQ) FDA

The term silicone covers a large group of materials in which vinyl-methyl-silicone (VMQ) is often the central ingredient. Silicone elastomers as a group have relatively low tensile strength, poor tear and wear resistance. Silicones have good heat resistance, good cold flexibility and good ozone and weather resistance as well as good insulating and physiologically neutral properties.

AFLAS® is a registered trademark of Asahi Glass Co.

03/28/06



Table 8-7. O-Ring Materials Properties

Code	O-Ring Material	Heat Resistance	Cold Flexibility	Chemical Resistance	Not Compatible with:
-1	Fluorocarbon (FKM)	Up to 400 °F (204 °C) and higher temperatures with shorter life expectancy.	Down to -15 °F (-26 °C) (some to -40 °F [-40 °C]).	<ul style="list-style-type: none"> Mineral oil and grease, low swelling in ASTM oil No. 1, and IRM 902 and IRM 903 oils. Non-flammable hydraulic fuels in the group HFD. Silicone oil and grease. Mineral and vegetable oil and grease. Aliphatic hydrocarbons (fuel, butane, propane, natural gas). Aromatic hydrocarbons (benzene, toluene). Chlorinated hydrocarbons (trichlorethylene and carbon tetrachloride). Fuels, also fuels with methanol content. High vacuum. Very good ozone, weather and aging resistance. 	<ul style="list-style-type: none"> Glycol based brake fluids. Ammonia gas, amines, alkalis. Superheated steam. Low molecular organic acids (formic and acetic acids).
-2	Fluorosilicone (FVMQ)	Up to 350 °F (177 °C) max.	Down to approximately -100 °F (-73 °C).	<ul style="list-style-type: none"> Aromatic mineral oils (IRM 903 oil). Fuels. Low molecular weight aromatic hydrocarbons (benzene, toluene). 	
-3	Acrylonitrile-Butadiene (NBR)	Up to 212 °F (100 °C) with shorter life @ 250 °F (121 °C).	Depending on individual compound, between -30 °F and -70 °F (-34 °C and -57 °C).	<ul style="list-style-type: none"> Aliphatic hydrocarbons (propane, butane, petroleum oil, mineral oil and grease, diesel fuel, fuel oils) vegetable and mineral oils and greases. HFA, HFB and HFC fluids. Dilute acids, alkali and salt solutions at low temperatures. Water (special compounds up to 212 °F [100°C]). 	<ul style="list-style-type: none"> Fuels of high aromatic content (for flex fuels a special compound must be used). Aromatic hydrocarbons (benzene). Chlorinated hydrocarbons (trichlorethylene). Polar solvents (ketone, acetone, acetic acid, ethyleneester). Strong acids. Brake fluid with glycol base. Ozone, weather and atmospheric aging.
-4	Tetrafluoroethylene-Propylene (AFLAS®)	Up to approximately 450 °F (232 °C).	Down to approximately 25 °F (-4 °C).	<ul style="list-style-type: none"> Bases. Phosphate Esters. Amines. Engine Oils. Steam. Pulp and paper liquors. 	<ul style="list-style-type: none"> Aromatic fuels. Ketones. Carbon Tetrachloride.
-5	Ethylene Propylene Rubber (EPM, EPDM)	Up to 302 °F (150 °C) (max. 400 °F (204 °C) in water and/or steam).	Down to approximately -70 °F (-57 °C).	<ul style="list-style-type: none"> Hot water and steam up to 300 °F (149 °C) with special compounds up to 400 °F (204 °C). Glycol based brake fluids up to 300 °F (149 °C). Many organic and inorganic acids. Cleaning agents, soda and potassium alkalis. Phosphate-ester based hydraulic fluids (HFD-R). Silicone oil and grease. Many polar solvents (alcohols, ketones, esters). Ozone, aging and weather resistant. 	<ul style="list-style-type: none"> Mineral oil products (oils, greases and fuels).
-6	Silicone Rubber (Q, MQ, VMQ, PVMQ) FDA	Up to approximately 400 °F (204 °C) (special compounds up to 450 °F (232 °C)).	Down to approximately -65 °F (-54 °C). With special compounds down to -175 °F (-115 °C).	<ul style="list-style-type: none"> Engine and transmission oil (e.g.: ASTM oil No.1). Animal and vegetable oil and grease. Brake fluid (non-petroleum base). Fire-resistant hydraulic fluid, HFD-R and HFD-S. High molecular weight chlorinated aromatic hydrocarbons (including flame-resistant insulators, and coolant for transformers). Moderate water resistance. Diluted salt solutions. Ozone, aging and weather resistant. 	<ul style="list-style-type: none"> Superheated water steam over 250 °F (121 °C). Acids and alkalis. Low molecular weight chlorinated hydrocarbons (trichloroethylene). Aromatic mineral oil. Hydrocarbon based fuels. Aromatic hydrocarbons (benzene, toluene).

03/28/06



ProTech™ Bearing Isolators

Product Offering

Catalog EPS 5350/USA

Part Number Nomenclature — ProTech

English

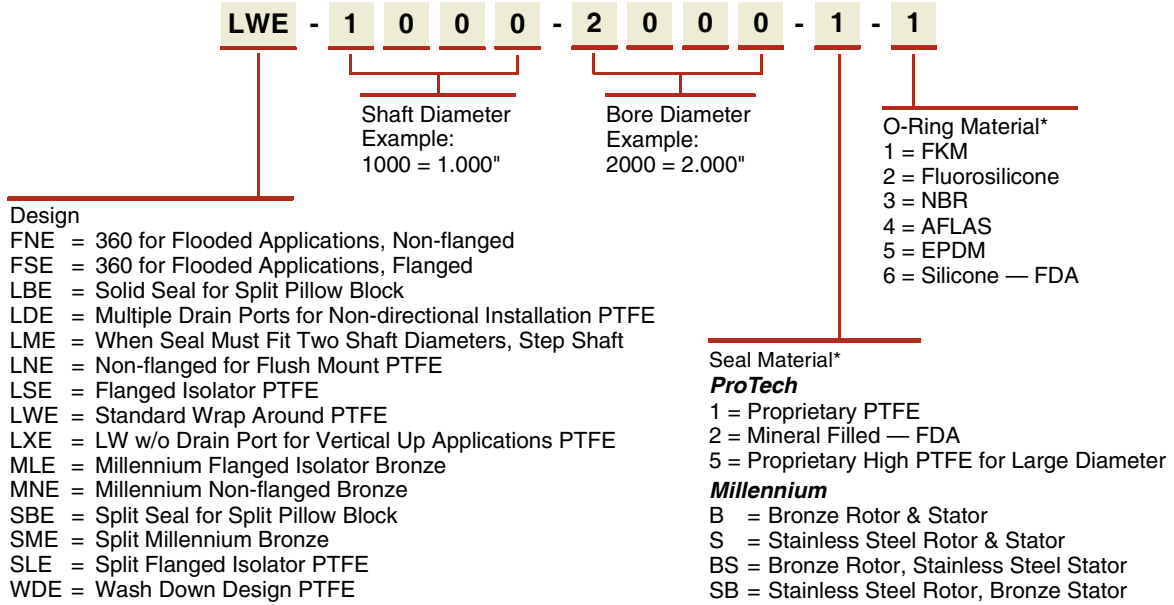

Metric

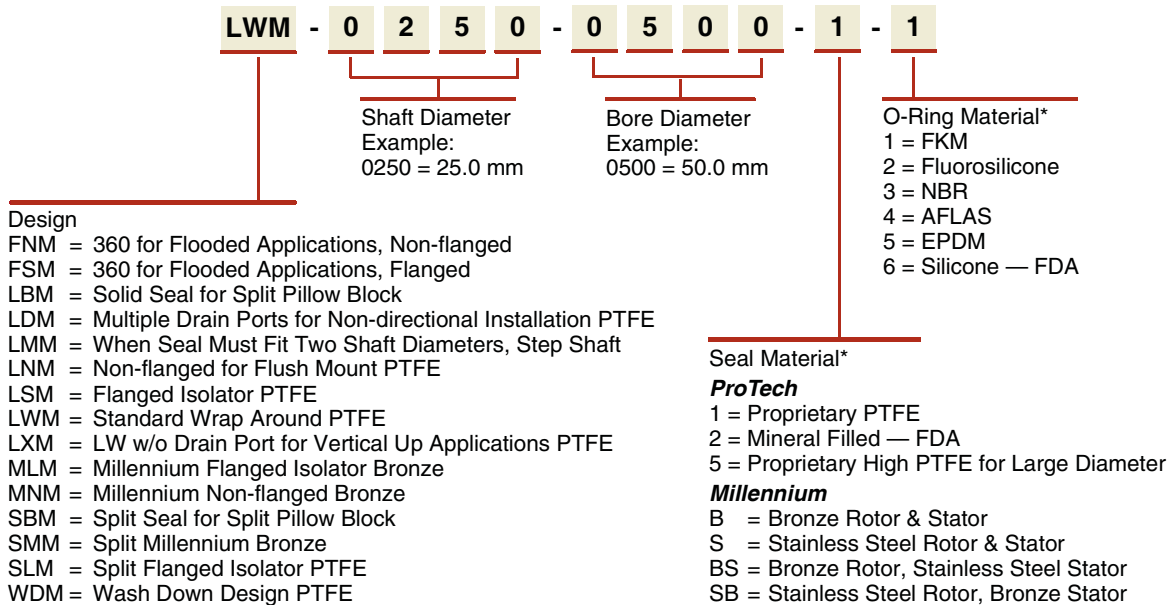

*Specials have Alphanumeric suffix here in place of material and O-ring code, example "AG31".

03/28/06





Product Line

ProTech is available in multiple designs to meet specific design requirements and geometry constraints.

- Available with or without flange to provide labyrinth sealing in restricted widths.
- Single and multiple expulsion ports available when directional installation is a problem.
- Exceeds IEEE-841 to provide premium bearing protection on severe-duty electric motors.
- New split pillow block design meets OEM specifications.

Profiles

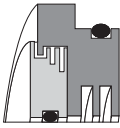
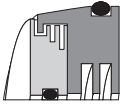
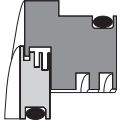
Table 8-8. Product Profiles

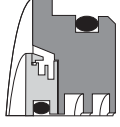
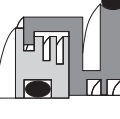
Series	Features	Applications	Page
 <p>LS</p>	<p>Flanged — General purpose sealing in flanged design. PTFE material. Excludes heavy water spray and dry contaminants from the bearing cavity. Retains grease and oil splash (oil level must be below inboard oil drain-back or non-flooded).</p>	Electric motors, pumps, mixers, gear boxes, blowers and custom equipment.	8-22
 <p>LN</p>	<p>Non-flanged — Specifically designed for flush mount applications. General purpose sealing in non-flanged design. PTFE material. Excludes heavy water spray and dry contaminants from the bearing cavity. Retains grease and oil splash (oil level must be below inboard oil drain-back or non-flooded).</p>	Electric motors, pumps, mixers, gear boxes, blowers and custom equipment.	8-23
 <p>LM</p>	<p>Step Shaft — Specifically designed to accommodate step shaft application. Flanged designs. PTFE material. Excludes heavy water spray and dry contaminants from the bearing cavity. Retains grease and oil splash (oil level must be below inboard oil drain-back or non-flooded).</p>	Electric motors, pumps, mixers, gear boxes, blowers and custom equipment.	See note below.
 <p>LW, LX</p>	<p>Wrap Around — Specifically designed for heavier water spray exclusion. Vertical up optional design is “LX,” same as “LW” but with no drain port. PTFE material. Excludes heavy water spray and dry contaminants from the bearing cavity. Retains grease and oil splash (oil level must be below inboard oil drain-back or non-flooded).</p>	Electric motors, pumps, mixers, gear boxes, blowers and custom equipment.	8-25
 <p>LD</p>	<p>Multi Port — For use in applications where drain port cannot be fixed at six o'clock position. PTFE material. Excludes heavy water spray and dry contaminants from the bearing cavity. Retains grease and oil splash (oil level must be below inboard oil drain-back or non-flooded).</p>	Electric motors, pumps, mixers, gear boxes, blowers and custom equipment.	See note below.
 <p>LB</p>	<p>Pillow Block — Solid seal design for sealing split pillow block bearings. PTFE material. Excludes heavy water spray and dry contaminants from the bearing cavity. Retains grease and oil splash (oil level must be below inboard oil drain-back or non-flooded).</p>	Drop in replacement for LER ring for split pillow block bearings. Easily interchanged by LER number and shaft diameter.	8-24





Note: LM Series: Call engineering for step shaft applications.
 LD Series: Call engineering for multi-port applications.

03/28/06

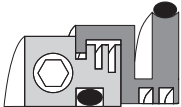

Table 8-8. Product Profiles (Continued)

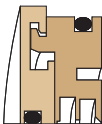
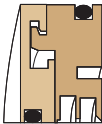
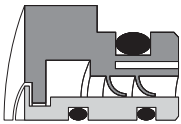
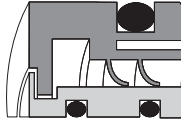
Series	Features	Applications	Page
SB 	Pillow Block — Split seal design for sealing split pillow block bearings. PTFE material. Excludes heavy water spray and dry contaminants from the bearing cavity. Retains grease and oil splash (oil level must be below inboard oil drain-back or non-flooded).	Drop in replacement for LER ring for split pillow block bearings. Easily interchanged by LER number and shaft diameter.	8-24
SL 	Split — Split design for field retrofits where equipment can not be uncoupled or disassembled. Requires no wear sleeves or shaft refurbishment. PTFE material. Excludes heavy water spray and dry contaminants from the bearing cavity. Retains grease and oil splash (oil level must be below inboard oil drain-back or non-flooded).	Electric motors, pumps, mixers, gear boxes, blowers and custom equipment.	8-27
WD 	Wash Down — Wash down purpose in narrow flanged designs. PTFE material. Specifically designed to exclude high pressure water spray and dry contaminants in limited space applications. For grease retention.	Small disposable electric motors and equipment for food processing industry. Economical for 140 & 480 frame IEEE 841 electric motors.	8-26
ML 	Flanged Millennium — Specifically designed for heavier water spray exclusion. Bronze material. Also excludes dry contaminants from the bearing cavity. Retains grease and oil splash (oil level must be below inboard oil drain-back or non-flooded).	Electric motors, pumps, mixers, gear boxes, blowers and custom equipment.	8-29
MN 	Non-flanged Millennium — Specifically designed for flush mount applications. General purpose sealing in non-flanged design. Bronze material. Excludes heavy water spray and dry contaminants from the bearing cavity. Retains grease and oil splash (oil level must be below inboard oil drain-back or non-flooded).	Electric motors, pumps, mixers, gear boxes, blowers and custom equipment.	8-30
FS 	Flanged 360 — Specifically designed for oil flooded and oil mist applications. Maximum 5 psi (0.3 bar) internal pressure. PTFE material with stainless steel rotor. Excludes heavy water spray and dry contaminants from the bearing cavity.	Electric motors, pumps, mixers, gear boxes, blowers, cooling towers, aerators and custom equipment. Oil mist lubrication systems.	8-31
FN 	Non-flanged 360 — Specifically designed for oil flooded and oil mist applications where seal must be flush mounted. Maximum 5 psi (0.3 bar) internal pressure. PTFE material with stainless steel rotor. Excludes heavy water spray and dry contaminants from the bearing cavity.	Electric motors, pumps, mixers, gear boxes, blowers, cooling towers, aerators and custom equipment. Oil mist lubrication systems.	8-32

Product Data

Table 8-9. Profile Properties

Series	Maximum Shaft Dynamic Runout (TIR)	Maximum Axial Movement	Maximum Shaft to Bore Misalignment (STBM)	Maximum Pressure	Maximum Shaft Surface Speed
LS, LN	0.020" (0.51 mm)	0.020" (0.51 mm) <i>Special Designs Available</i>	± 0.020" (± 0.51 mm) <i>Special Designs Available</i>	0	Up to 5,000 fpm (25 m/s)
LM	0.020" (0.51 mm)	0.020" (0.51 mm) <i>Special Designs Available</i>	± 0.020" (± 0.51 mm) <i>Special Designs Available</i>	0	Up to 5,000 fpm (25 m/s)
LW, LX	0.020" (0.51 mm)	0.020" (0.51 mm) <i>Special Designs Available</i>	± 0.020" (± 0.51 mm) <i>Special Designs Available</i>	0	Up to 3,000 fpm (15 m/s)
LD	0.020" (0.51 mm)	0.020" (0.51 mm) <i>Special Designs Available</i>	± 0.020" (± 0.51 mm) <i>Special Designs Available</i>	0	Up to 5,000 fpm (25 m/s)
LB	0.020" (0.51 mm)	0.020" (0.51 mm) <i>Special Designs Available</i>	± 0.020" (± 0.51 mm) <i>Special Designs Available</i>	0	Up to 5,000 fpm (25 m/s)
SL	0.020" (0.51 mm)	0.020" (0.51 mm) <i>Special Designs Available</i>	± 0.020" (± 0.51 mm) <i>Special Designs Available</i>	0	Up to 3,000 fpm (15 m/s) <i>Contact Factory for Speeds Over 3,000 fpm (15 m/s)</i>
WD	0.020" (0.51 mm)	0.020" (0.51 mm) <i>Special Designs Available</i>	± 0.020" (± 0.51 mm) <i>Special Designs Available</i>	0	Up to 3,000 fpm (15 m/s) <i>Contact Factory for Speeds Over 3,000 fpm (15 m/s)</i>
ML, MN	0.010" (0.25 mm)	0.010" (0.25 mm) <i>Special Designs Available</i>	± 0.010" (± 0.25 mm) <i>Special Designs Available</i>	0	Up to 7,000 fpm (35 m/s)
FS, FN	0.003" (0.08 mm)	0.003" (0.08 mm) <i>Special Designs Available</i>	± 0.005" (± 0.13 mm) <i>Special Designs Available</i>	5 psi (0.3 bar)	Up to 5,000 fpm (25 m/s) <i>Contact Factory for Speeds Over 3,000 fpm (15 m/s)</i>



Custom Design Examples

Parker can configure custom bearing isolator designs to fit most applications. Contact Parker's application engineers for design assistance.

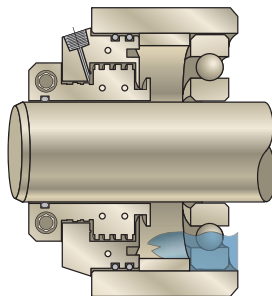

Split Air Purge

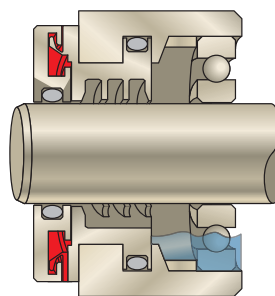

Turbine

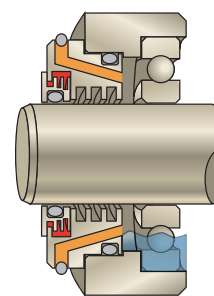

Grease Purge

03/28/06



ProTech™ Bearing Isolators

LS Profile

Catalog EPS 5350/USA

LS — Flanged Design

Retain: Grease and oil splash (operating oil level in cavity between seal and bearing must be below inboard oil drain-back port of seal)

Exclude: Heavy water spray and dry contaminants from bearing cavity, best for vertical down applications

Equipment: Motors, pumps, mixers, gearboxes, blowers and custom equipment

Technical Data

Total Eccentricity: 0.020" (0.51 mm)

Shaft Speed: Up to 5,000 fpm (25 m/s)

Pressure: 0 psi/bar

Temperature Range: -40 to 250 °F (-40 to 121 °C)

Axial Movement: 0.020" (0.51 mm)

Special designs up to 0.070" (1.78 mm)

Shaft/Bore: Tolerances: ± .002" (± .05 mm) Special designs available

Seal Material

Standard: Proprietary PTFE

Optional: Food grade, Anti microbial, FDA 3A

O-Ring Material

Standard: FKM

Optional: NBR, FDA silicone, EPDM, Afias®†

† Afias® is a registered trademark of Asahi Glass Co.

Table 8-10. LS Mounting and Lubrication

	Mounting		Lubrication		
	Position	Grease	Oil	Dry	
Horizontal	Y	Y	Y	Y	Y
Vertical Up	Y*	Y	Y	Y	Y
Vertical Down	Y	Y	N	Y	Y

* If contaminant level is heavy see LW Profile on Page 8-25.

Dimensions — LS Profile

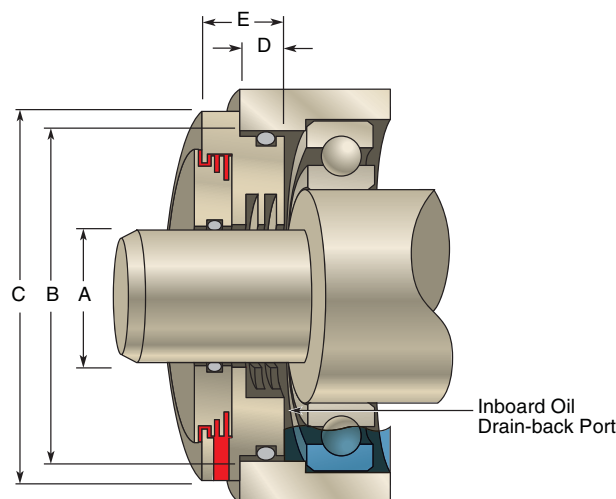

Table 8-11. LSE Standard Dimensions — Inch/Fractional

Type	"A" Shaft Diameter Range Inch	"B" Bore Diameter Range Is Shaft Diameter "A" + Min-Max	"C" Flange Diameter = "B" +	"D" In Bore Depth	"E" Overall Seal Width
LSE	0.500 – 3.000	0.625 – 1.500	0.250	0.313	0.688
LSE	3.001 – 4.000	0.625 – 1.500	0.250	0.375	0.750
LSE	4.001 – 6.000	0.874 – 1.500	0.250	0.375	0.750
LSE	6.001 – 10.000 ²	0.874 – 1.500	0.250	0.438	0.815

Table 8-12. LSM Standard Dimensions — Metric

Type	"A" Shaft Diameter Range Metric	"B" Bore Diameter Range Is Shaft Diameter "A" + Min-Max	"C" Flange Diameter = "B" +	"D" In Bore Depth	"E" Overall Seal Width
LSM	12.0 – 40.0	10.0 – 40.0	6.0 ¹	7.0	16.0
LSM	40.1 – 60.0	12.0 – 40.0	6.0 ¹	8.0	17.0
LSM	60.1 – 80.0	15.0 – 40.0	6.0 ¹	9.0	18.0
LSM	80.1 – 130.0	20.0 – 40.0	6.0	9.0	18.0
LSM	131.0 – 254.0 ²	24.0 – 40.0	6.0	11.0	20.0

¹ May be larger for small cross-sections. Consult factory for dimensions.

² Contact factory for requirements outside of standard dimensions listed above. Note: Cross-Section = (Bore – Shaft) / 2

Important: For a listing of popular sizes, see Appendix F.

03/28/06



ProTech™ Bearing Isolators

LN Profile

Catalog EPS 5350/USA

LN — Flush Mount Design

Retain: Grease and oil splash (operating oil level in cavity between seal and bearing must be below inboard oil drain-back port of seal)

Exclude: Heavy water spray and dry contaminants from bearing cavity

Equipment: Applications requiring seal to be flush mounted to equipment housing. Motors, pumps, mixers, gearboxes, blowers and custom equipment

Technical Data

Total Eccentricity: 0.020" (0.51 mm)

Shaft Speed: Up to 5,000 fpm (25 m/s)

Pressure: 0 psi/bar

Temperature Range: -40 to 250 °F (-40 to 121 °C)

Axial Movement: 0.020" (0.51 mm)
Special designs up to 0.070" (1.78 mm)

Shaft/Bore: Tolerances: ± .002" (± .05 mm) Special designs available

Seal Material

Standard: Proprietary PTFE

Optional: Food grade, Anti microbial, FDA 3A

O-Ring Material

Standard: FKM

Optional: NBR, FDA silicone, EPDM, Atlas®

Table 8-13. LN Mounting and Lubrication

	Mounting		Lubrication		
	Position	Grease	Oil	Dry	
Horizontal	Y	Y	Y	Y	
Vertical Up	NR*	Y	Y	Y	
Vertical Down	Y	Y	N	Y	

* Not recommended (NR). If contaminant level is heavy see LW Profile on **Page 8-25**.

Dimensions — LN Profile

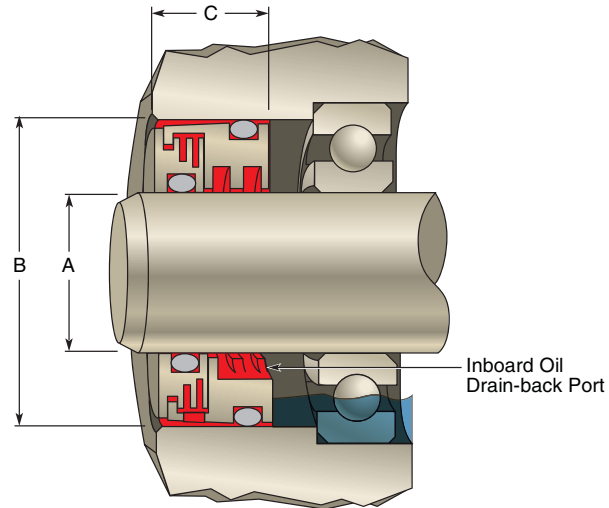

Table 8-14. LNE Standard Dimensions — Inch/Fractional

Type	"A" Shaft Diameter Range Inch	"B" Bore Diameter Range Is Shaft Diameter "A" + Min-Max	"C" In Bore Depth
LNE	0.500 – 4.000	0.750 – 1.500	0.562
LNE	4.001 – 10.000 ¹	0.874 – 1.500	0.625

Table 8-15. LNM Standard Dimensions — Metric

Type	"A" Shaft Diameter Range Metric	"B" Bore Diameter Range Is Shaft Diameter "A" + Min-Max	"C" In Bore Depth
LNM	12.0 – 80.0	14.0 – 40.0	10.0
LNM	80.1 – 130.0	16.0 – 40.0	12.0
LNM	131.1 – 250.0 ¹	18.0 – 40.0	15.0

¹ Contact factory for requirements outside of standard dimensions listed above.
Note: Cross-Section = (Bore – Shaft) / 2

Important: For a listing of popular sizes, see **Appendix F**.



03/28/06



ProTech™ Bearing Isolators

LB, SB Profiles

Catalog EPS 5350/USA

LB, SB — Split Pillow Block Design

Retain: Grease and oil splash (operating oil level in cavity between seal and bearing must be below inboard oil drain-back port of seal)

Exclude: Heavy water spray and dry contaminants from bearing cavity. Excellent for taconite exclusion

Equipment: Drop-in replacement for LER seal. Available as a solid or split seal. Easily interchanged by LER No. and shaft diameter. Contact authorized distributor for complete interchange

Technical Data

Total Eccentricity: 0.020" (0.51 mm)

Shaft Speed: Up to 5,000 fpm (25 m/s)

Pressure: 0 psi/bar

Temperature Range: -40 to 250 °F (-40 to 121 °C)

Axial Movement: 0.020" (0.51 mm)
Special designs up to 0.070" (1.78 mm)

Shaft/Bore: Tolerances: ± .002" (± .05 mm) Special designs available

Seal Material

Standard: Proprietary PTFE

Optional: Food grade, Anti microbial, FDA 3A

O-Ring Material

Standard: FKM

Optional: NBR, FDA silicone, EPDM, Aflas®

Table 8-16. LB Mounting and Lubrication

Mounting	Lubrication			
	Position	Grease	Oil	Dry
Horizontal	Y	Y	Y	Y
Vertical Up	Y	Y	Y	Y
Vertical Down	Y	Y	N	Y

Dimensions — LB Profile

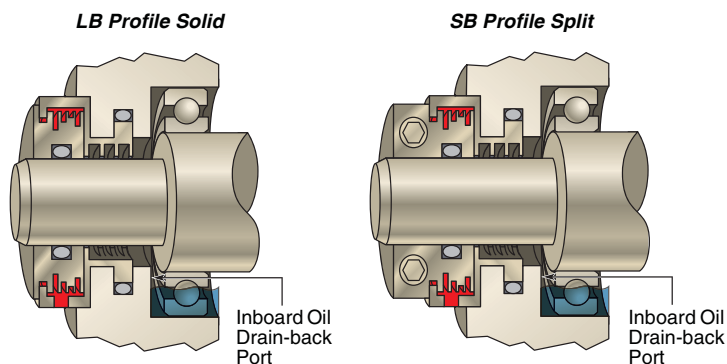

Table 8-17. Solid Seal Interchange for Split Pillow Block

Housing	Shaft	LER	ProTech Part No.
SAF 211, 209, 212, 309, 311, 513	2-1/4	30	LBE-2250-2823-J64
SAF 210, 310	2-3/8	35	LBE-2375-2948-M07
SAF 213, 313, 515, 615	2-7/16	37	LBE-2438-3188-D96
SAF 213, 313, 515, 615	2-1/2	38	LBE-2500-3188-J61
SAF 211, 311	2-9/16	40	LBE-2563-3198-K90
SAF 215, 312, 314, 516, 616	2-5/8	43	LBE-2625-3563-AI58
SAF 215, 312, 314, 516, 616	2-11/16	44	LBE-2688-3563-D97
SAF 215, 312, 314, 516, 616	2-3/4	45	LBE-2750-3563-R52
SAF 213, 216, 313, 517	2-15/16	53	LBE-2938-3813-B77
SAF 520, 620	3-7/16	102	LBE-3438-4460-C65
SAF 317, 522, 622	3-15/16	109	LBE-3938-4960-D98
SAF 220, 224, 320, 324, 526, 626	4-7/16	117	LBE-4438-5543-D36
SAF 222, 226, 322, 326, 528, 625	4-15/16	122	LBE-4938-5980-E29
SAF 224, 228, 324, 328, 530, 630	5-5/16	127	LBE-5313-6375-C97
SAF 532, 632	5-7/16	130	LBE-5438-6750-E30
SAF 232, 332, 534, 634	5-15/16	140	LBE-5938-7343-E92
SAF 234, 334, 536	6-7/16	148	LBE-6437-7780-E45
SAF 332, 336, 538, 638	6-15/16	224	LBE-6938-8282-K52
SAF 238, 338, 540, 640	7-5/16	228	LBE-7313-8570-G56
SAF 234, 240, 334, 340	7-7/16	161	LBE-7438-8945-D02

Important: Partial list only. Please call factory for additional interchanges.

03/28/06



ProTech™ Bearing Isolators

LW Profile

Catalog EPS 5350/USA

LW — Wrap Around Design

Retain: Grease and oil splash (operating oil level in cavity between seal and bearing must be below inboard oil drain-back port of seal)

Exclude: Heavy water spray and dry contaminants from bearing cavity

Equipment: Motors, pumps, mixers, gearboxes, blowers and custom equipment

Technical Data

Total Eccentricity: 0.020" (0.51 mm)

Shaft Speed: Up to 5,000 fpm (25 m/s)

Pressure: 0 psi/bar

Temperature Range: -40 to 250 °F (-40 to 121 °C)

Axial Movement: 0.020" (0.51 mm)
Special designs up to 0.070" (1.78 mm)

Shaft/Bore: Tolerances: ± .002" (± .05 mm) Special designs available

Seal Material

Standard: Proprietary PTFE

Optional: Food grade, Anti microbial, FDA 3A

O-Ring Material

Standard: FKM

Optional: NBR, FDA silicone, EPDM, Aflas®

Table 8-18. LW Mounting and Lubrication

Mounting	Lubrication			
	Position	Grease	Oil	Dry
Horizontal	Y	Y	Y	Y
Vertical Up	Y*	Y	Y	Y
Vertical Down	Y	Y	N	Y

* Optional LX Profile (w/o drain port) recommended.

Dimensions — LW Profile

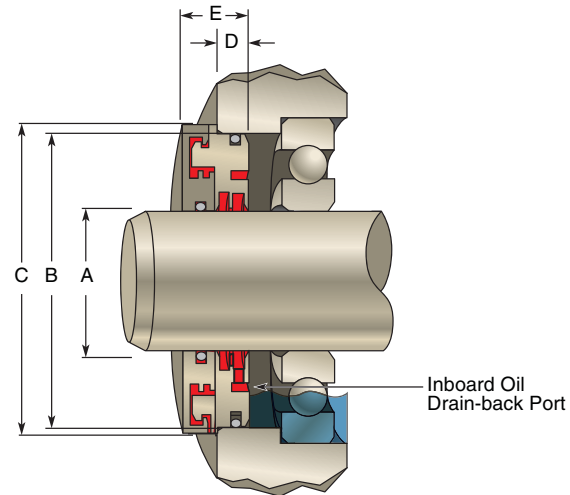

Table 8-19. LWE Standard Dimensions — Inch/Fractional

Type	"A" Shaft Diameter Range Inch	"B" Bore Diameter Range Is Shaft Diameter "A" + Min-Max	"C" Flange Diameter = "B" +	"D" In Bore Depth	"E" Overall Seal Width
LWE ²	0.492 – 1.575	0.394 – 1.575	0.236 ³	0.276	0.630
LWE ²	1.576 – 2.362	0.472 – 1.575	0.236 ³	0.315	0.669
LWE ²	2.363 – 3.150	0.630 – 1.575	0.236 ³	0.354	0.709
LWE	3.151 – 5.118	0.866 – 1.575	0.236	0.354	0.709
LWE	5.119 – 10.000 ⁴	0.945 – 1.575	0.236	0.433	0.787

Table 8-20. LWM Standard Dimensions — Metric

Type	"A" Shaft Diameter Range Metric	"B" Bore Diameter Range Is Shaft Diameter "A" + Min-Max	"C" Flange Diameter = "B" +	"D" In Bore Depth	"E" Overall Seal Width
LWM ²	12.5 – 40.0	10.0 – 40.0	6.0 ³	7.0	16.0
LWM ²	40.1 – 60.0	12.0 – 40.0	6.0 ³	8.0	17.0
LWM ²	60.1 – 80.0	15.0 – 40.0	6.0 ³	9.0	18.0
LWM	80.1 – 130.0	20.0 – 40.0	6.0	9.0	18.0
LWM	130.1 – 254.0 ⁴	24.0 – 40.0	6.0	11.0	20.0

² Shaft diameters under 1.575" (40 mm) and cross-sections under 0.433" (11 mm) have standard inboard oil splash grooves.
Note: Cross-Section = (Bore – Shaft) / 2

³ May be larger for small cross-sections. Consult factory for dimensions.

⁴ Contact factory for requirements outside of standard dimensions listed above.

Important: For a listing of popular sizes, see **Appendix F**.

03/28/06



ProTech™ Bearing Isolators

WD Profile

Catalog EPS 5350/USA

WD — Wash Down Motor Design (Meets IP69k)

Retain: Grease and oil splash (operating oil level in cavity between seal and bearing must be below inboard oil drain-back port of seal)

Exclude: Heavy water spray and dry contaminants from bearing cavity

Equipment: Small disposable motors and equipment for food processing industry; economical seal for 140 and 180 frame motors and other high volume OEM equipment requiring wash down protection where cost to upgrade the seal has been a deterrent.

Technical Data

Total Eccentricity: 0.020" (0.51 mm)

Shaft Speed: Up to 3,000 fpm (15 m/s)¹

Pressure: 0 psi/bar

Temperature Range: -40 to 250 °F (-40 to 121 °C)

Axial Movement: 0.020" (0.51 mm)
Special designs up to 0.070" (1.78 mm)

Shaft/Bore: Tolerances: ± .002" (± .05 mm) Special designs available

Seal Material

Standard: Proprietary PTFE

Optional: Food grade, Anti microbial, FDA 3A

O-Ring Material

Standard: FKM

Optional: NBR, FDA silicone, EPDM, Aflas®

Table 8-21. WD Mounting and Lubrication

	Mounting		Lubrication		
	Position	Grease	Oil	Dry	
Horizontal	Y	Y	N	Y	
Vertical Up	Y	Y	N	Y	
Vertical Down	Y	Y	N	Y	

Dimensions — WD Profile

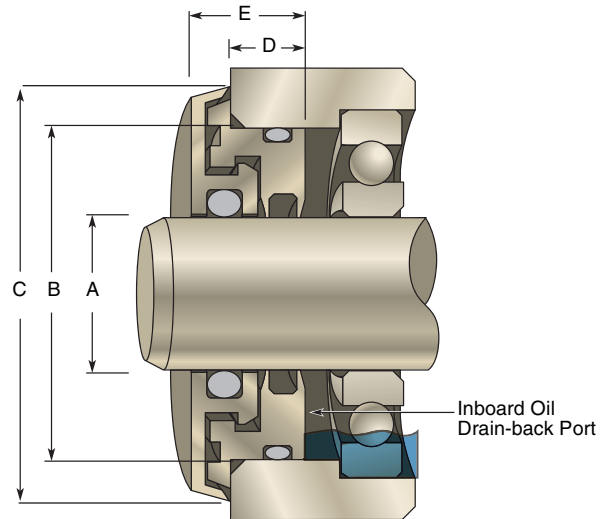

Table 8-22. WDE Standard Dimensions — Inch/Fractional

Type	"A" Shaft Diameter Range Inch	"B" Bore Diameter Range Is Shaft Diameter "A" + Min-Max	"C" Flange Diameter = "B" +	"D" In Bore Depth	"E" Overall Seal Width
WDE	0.492 – 1.575	0.551 – 1.575	0.269 ²	0.248	0.373
WDE	1.576 – 2.362	0.669 – 1.575	0.269 ²	0.248	0.373
WDE	2.363 – 3.150	0.787 – 1.575	0.269 ²	0.287	0.412
WDE	3.151 – 5.118	0.866 – 1.575	0.269	0.287	0.412
WDE	5.119 – 10.000 ³	0.945 – 1.575	0.269	0.287	0.412

Table 8-23. WDM Standard Dimensions — Metric

Type	"A" Shaft Diameter Range Metric	"B" Bore Diameter Range Is Shaft Diameter "A" + Min-Max	"C" Flange Diameter = "B" +	"D" In Bore Depth	"E" Overall Seal Width
WDM	12.5 – 40.0	14.0 – 40.0	6.8 ²	6.3	9.5
WDM	40.1 – 60.0	17.0 – 40.0	6.8 ²	6.3	9.5
WDM	60.1 – 80.0	20.0 – 40.0	6.8 ²	7.3	10.5
WDM	80.1 – 130.0	22.0 – 40.0	6.8	7.3	10.5
WDM	130.1 – 254.0 ³	24.0 – 40.0	6.8	7.3	10.5

¹ Contact factory for speeds over 3,000 fpm (15 m/s).

² May be larger for small cross-sections. Consult factory for dimensions.

³ Contact factory for requirements outside of standard dimensions listed above.
Note: Cross-Section = (Bore – Shaft) / 2

03/03/06



ProTech™ Bearing Isolators

SL Profile

Catalog EPS 5350/USA

SL — Split Design

Retain: Grease and oil splash (operating oil level in cavity between seal and bearing must be below inboard oil drain-back port of seal)

Exclude: Heavy water spray and dry contaminants from bearing cavity

Equipment: For field retrofits where equipment cannot be uncoupled or disassembled. Requires no wear sleeves or shaft refurbishment. Motors, pumps, mixers, gearboxes, blowers and custom equipment

Technical Data

Total Eccentricity: 0.020" (0.51 mm)

Shaft Speed: Up to 3,000 fpm (15 m/s)¹

Pressure: 0 psi/bar

Temperature Range: -40 to 250 °F (-40 to 121 °C)

Axial Movement: 0.020" (0.51 mm)
Special designs up to 0.070" (1.78 mm)

Shaft/Bore: Tolerances: ± .002" (± .05 mm) Special designs available

Seal Material

Standard: Proprietary PTFE

Optional: Food grade, Anti microbial, FDA 3A

O-Ring Material

Standard: FKM

Optional: NBR, FDA silicone, EPDM, Atlas®

Table 8-24. SL Mounting and Lubrication

	Mounting		Lubrication		
	Position	Grease	Oil	Dry	
Horizontal	Y	Y	Y	Y	
Vertical Up	Y	Y	Y	Y	
Vertical Down	Y*	Y	N	Y	

* Locking collar may be required.

Dimensions — SL Profile

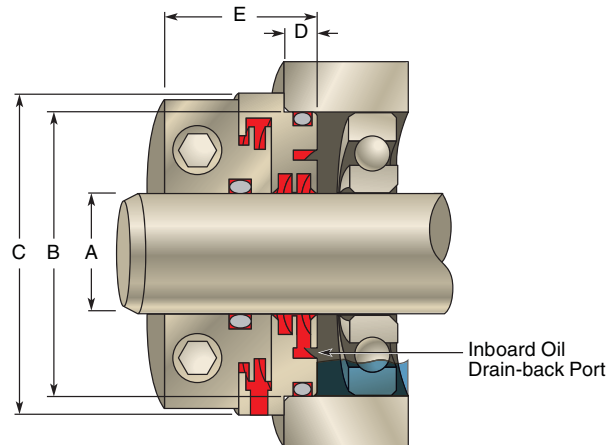

Table 8-25. SLE Standard Dimensions — Inch/Fractional

Type	"A" Shaft Diameter Range Inch	"B" Bore Diameter Range Is Shaft Diameter "A" + Min-Max	"C" Flange Diameter = "B" +	"D" In Bore Depth	"E" Overall Seal Width
SLE ²	0.492 – 1.575	0.394 – 1.575	0.236 ³	0.276	1.078
SLE ²	1.576 – 2.362	0.472 – 1.575	0.236 ³	0.315	1.117
SLE ²	2.363 – 3.150	0.551 – 1.575	0.236 ³	0.354	1.156
SLE	3.151 – 5.118	0.787 – 1.575	0.236 ³	0.354	1.257
SLE	5.119 – 10.000 ⁴	0.945 – 1.575	0.236 ³	0.433	1.436

Table 8-26. SLM Standard Dimensions — Metric

Type	"A" Shaft Diameter Range Metric	"B" Bore Diameter Range Is Shaft Diameter "A" + Min-Max	"C" Flange Diameter = "B" +	"D" In Bore Depth	"E" Overall Seal Width
SLM ²	12.5 – 40.0	10.0 – 40.0	6.0 ³	7.0	27.4
SLM ²	40.1 – 60.0	12.0 – 40.0	6.0 ³	8.0	28.4
SLM ²	60.1 – 80.0	14.0 – 40.0	6.0 ³	9.0	29.4
SLM	80.1 – 130.0	20.0 – 40.0	6.0 ³	9.0	31.9
SLM	130.1 – 254.0 ⁴	24.0 – 40.0	6.0 ³	11.0	36.5

¹ Contact factory for speeds over 3,000 fpm (15 m/s).

² Shaft diameters under 1.575" (40 mm) or cross-sections under 0.433" (11 mm) have standard inboard oil splash grooves.
Note: Cross-Section = (Bore – Shaft) / 2

³ May be larger for small cross-sections. Consult factory for dimensions.

⁴ Contact factory for requirements outside of standard dimensions listed above.

Important: Contact factory for available sizes.



03/28/06



ProTech™ Bearing Isolators

SM Profile

Catalog EPS 5350/USA

SM — Split Millennium Design

Retain: Grease and oil splash (operating oil level in cavity between seal and bearing must remain below inboard oil drain-back port of seal)

Exclude: Heavy water spray and dry contaminants from bearing cavity

Equipment: For field retrofits where equipment can not be uncoupled or disassembled. Requires no wear sleeves or shaft refurbishment. Motors, pumps, mixers, gearboxes, blowers and custom equipment

Technical Data

Total Eccentricity: 0.020" (0.51 mm)

Shaft Speed: Up to 3,000 fpm (15 m/s)¹

Pressure: 0 psi/bar

Temperature Range: -40 to 400 °F (-40 to 204 °C)

Axial Movement: 0.020" (0.51 mm)
Special designs up to 0.100" (2.54 mm)

Shaft/Bore: Tolerances: ± .002" (± .05 mm) Special designs available

Seal Material

Standard: Bronze

Optional: 302 SS, 304 SS, 316 SS, Carbon Steel

O-Ring Material

Standard: FKM

Optional: NBR, FDA silicone, EPDM, Atlas®

Table 8-27. SM Mounting and Lubrication

Mounting	Lubrication			
	Position	Grease	Oil	Dry
Horizontal	Y	Y	Y	Y
Vertical Up	Y	Y	Y	Y
Vertical Down	Y*	Y	N	Y

* Locking collar may be required.

Dimensions — SM Profile

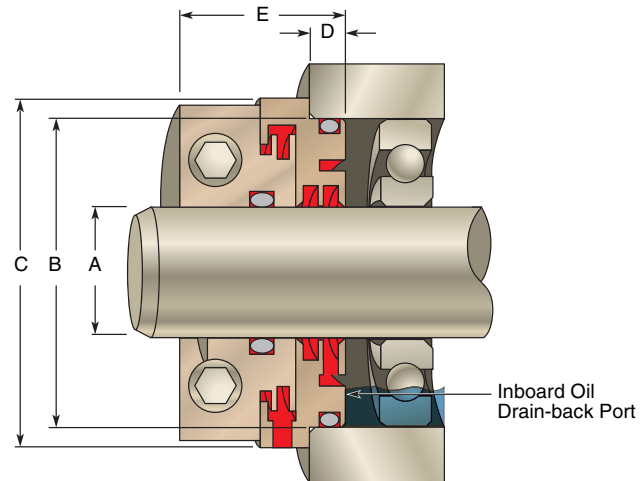

Table 8-28. SME Standard Dimensions — Inch/Fractional

Type	"A" Shaft Diameter Range Inch	"B" Bore Diameter Range Is Shaft Diameter "A" + Min-Max	"C" Flange Diameter = "B" +	"D" In Bore Depth	"E" Overall Seal Width
SME ²	0.610 – 1.575	0.709 – 1.575	0.236 ³	0.276	1.078
SME	1.576 – 2.362	0.709 – 1.575	0.236 ³	0.315	1.117
SME	2.363 – 3.150	0.709 – 1.575	0.236 ³	0.354	1.156
SME	3.151 – 5.118	0.787 – 1.575	0.236 ³	0.354	1.257
SME	5.119 – 10.000 ⁴	0.945 – 1.575	0.236 ³	0.433	1.436

Table 8-29. SMM Standard Dimensions — Metric

Type	"A" Shaft Diameter Range Metric	"B" Bore Diameter Range Is Shaft Diameter "A" + Min-Max	"C" Flange Diameter = "B" +	"D" In Bore Depth	"E" Overall Seal Width
SMM ²	15.5 – 40.0	18.0 – 40.0	6.0 ³	7.0	27.4
SMM	40.1 – 60.0	18.0 – 40.0	6.0 ³	8.0	28.4
SMM	60.1 – 80.0	18.0 – 40.0	6.0 ³	9.0	29.4
SMM	80.1 – 130.0	20.0 – 40.0	6.0 ³	9.0	31.9
SMM	130.1 – 254.0 ⁴	24.0 – 40.0	6.0 ³	11.0	36.5

¹ Contact factory for speeds over 3,000 fpm (15 m/s).

² Shaft diameters under 1.575" (40 mm) or cross-sections under 0.433" (11 mm) have standard inboard oil splash grooves.
Note: Cross-Section = (Bore – Shaft) / 2

³ May be larger for small cross-sections. Consult factory for dimensions.

⁴ Contact factory for requirements outside of standard dimensions listed above.

Important: Contact factory for available sizes.

03/28/06



ProTech™ Bearing Isolators

ML Profile

Catalog EPS 5350/USA

ML — Flanged Millennium® Design

Retain: Grease and oil splash (operating oil level in cavity between seal and bearing must be below inboard oil drain-back port of seal)

Exclude: Heavy water spray and dry contaminants from bearing cavity

Equipment: Gearboxes, motors, pumps, mixers, turbines, blowers and custom equipment

Technical Data

Total Eccentricity: 0.020" (0.51 mm)

Shaft Speed: Up to 7,000 fpm (35 m/s)

Pressure: 0 psi/bar

Temperature Range: -40 to 400 °F (-40 to 204 °C)

Axial Movement: 0.020" (0.51 mm)
Special designs up to 0.100" (0.05 mm)

Shaft/Bore: Tolerances: ± .002" (± .05 mm) Special designs available

Seal Material

Standard: Bronze

Optional: 302 SS, 304 SS, 316 SS, Carbon Steel

O-Ring Material

Standard: FKM

Optional: NBR, FDA silicone, EPDM, Aflas®

Table 8-30. ML Mounting and Lubrication

	Mounting		Lubrication		
	Position	Grease	Oil	Dry	
Horizontal	Y	Y	Y	Y	
Vertical Up	Y*	Y	Y	Y	
Vertical Down	Y	Y	N	Y	

* Optional MX Profile (w/o drain port) recommended.

Dimensions — ML Profile

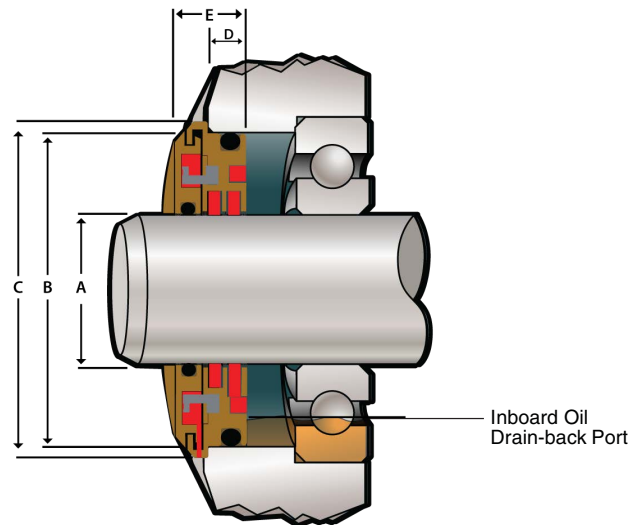

Table 8-31. MLE Standard Dimensions — Inch/Fractional

Type	"A" Shaft Diameter Range Inch	"B" Bore Diameter Range Is Shaft Diameter "A" + Min-Max	"C" Flange Diameter = "B" +	"D" In Bore Depth	"E" Overall Seal Width
MLE ¹	0.610 – 1.575	0.394 – 1.575	0.125 ²	0.276	0.551
MLE ¹	1.576 – 2.362	0.472 – 1.575	0.125 ²	0.315	0.591
MLE ¹	2.363 – 3.150	0.630 – 1.575	0.125 ²	0.354	0.630
MLE	3.151 – 5.118	0.866 – 1.575	0.125 ²	0.354	0.630
MLE	5.119 – 12.000 ³	0.945 – 1.575	0.125 ²	0.433	0.709

Table 8-32. MLM Standard Dimensions — Metric

Type	"A" Shaft Diameter Range Metric	"B" Bore Diameter Range Is Shaft Diameter "A" + Min-Max	"C" Flange Diameter = "B" +	"D" In Bore Depth	"E" Overall Seal Width
MLM ¹	15.5 – 40.0	18.0 – 40.0	3.2 ²	7.0	14.0
MLM ¹	40.1 – 60.0	12.0 – 40.0	3.2 ²	8.0	15.0
MLM ¹	60.1 – 80.0	16.0 – 40.0	3.2 ²	9.0	16.0
MLM	80.1 – 130.0	22.0 – 40.0	3.2 ²	9.0	16.0
MLM	130.1 – 304.8 ³	24.0 – 40.0	3.2 ²	11.0	18.0

¹ Shaft diameters under 1.575" (40 mm) or cross-sections under 0.433" (11 mm) have standard inboard oil splash grooves.

Note: Cross-Section = (Bore – Shaft) / 2

² May be larger for small cross-sections. Consult factory for dimensions.

³ Contact factory for requirements outside of standard dimensions listed above.

Important: For a listing of popular sizes, see **Appendix F**.



03/28/06



ProTech™ Bearing Isolators

MN Profile

Catalog EPS 5350/USA

MN — Flush Mount Millennium Design

Retain: Grease and oil splash (operating oil level in cavity between seal and bearing must be below inboard oil drain-back port of seal)

Exclude: Heavy water spray and dry contaminants from bearing cavity

Equipment: Gearboxes, motors, pumps, mixers, turbines, blowers and custom equipment

Technical Data

Total Eccentricity: 0.010" (0.25 mm)

Shaft Speed: Up to 7,000 fpm (35 m/s)

Pressure: 0 psi/bar

Temperature Range: -40 to 400 °F (-40 to 204 °C)

Axial Movement: 0.020" (0.51 mm)
Special designs up to 0.100" (2.55 mm)

Shaft/Bore: Tolerances: ± .002" (± .05 mm) Special designs available

Seal Material

Standard: Bronze

Optional: 302 SS, 304 SS, 316 SS, Carbon Steel

O-Ring Material

Standard: FKM

Optional: NBR, FDA silicone, EPDM, Atlas®

Table 8-33. MN Mounting and Lubrication

	Mounting		Lubrication		
	Position		Grease	Oil	Dry
Horizontal	Y		Y	Y	Y
Vertical Up	NR*		Y	Y	Y
Vertical Down	Y		Y	N	Y

* Not recommended (NR). If contaminant level is heavy see ML Profile on **Page 8-29**.

Dimensions — MN Profile

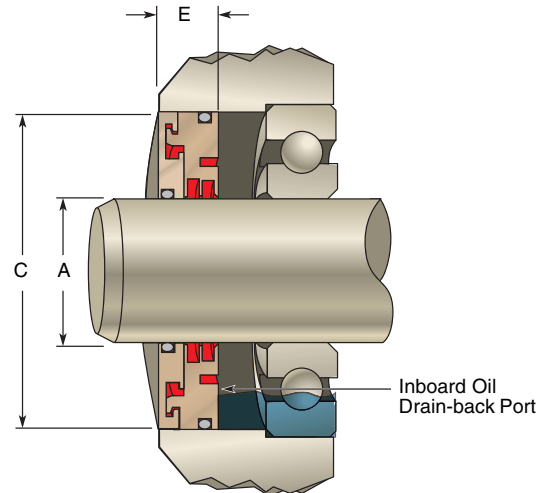

Table 8-34. MNE Standard Dimensions — Inch/Fractional

Type	"A" Shaft Diameter Range Inch	"B" Bore Diameter Range Is Shaft Diameter "A" + Min-Max	"E" In Bore Depth
MNE ¹	0.610 – 1.575	0.748 – 1.575	0.551
MNE ¹	1.576 – 2.362	0.748 – 1.575	0.591
MNE ¹	2.363 – 3.150	0.748 – 1.575	0.630
MNE	3.151 – 5.118	0.866 – 1.575	0.630
MNE	5.119 – 12.000 ²	0.945 – 1.575	0.709

Table 8-35. MNM Standard Dimensions — Metric

Type	"A" Shaft Diameter Range Metric	"B" Bore Diameter Range Is Shaft Diameter "A" + Min-Max	"E" In Bore Depth
MNM ¹	15.5 – 40.0	19.0 – 40.0	14.0
MNM ¹	40.1 – 60.0	19.0 – 40.0	15.0
MNM ¹	60.1 – 80.0	19.0 – 40.0	16.0
MNM	80.1 – 130.0	22.0 – 40.0	16.0
MNM	130.1 – 304.8 ²	24.0 – 40.0	18.0

¹ Shaft diameters under 1.575" (40 mm) or cross-sections under 0.433" (11 mm) have standard inboard oil splash grooves.

Note: Cross-Section = (Bore – Shaft) / 2

² Contact factory for requirements outside of standard dimensions listed above.

Important: For a listing of popular sizes, see **Appendix F**.

03/03/06



ProTech™ Bearing Isolators

FS-360 Profile

Catalog EPS 5350/USA

FS-360 — Flanged Flooded Design

Retain: Grease, oil splash, oil mist or oil flooded

Exclude: Heavy water spray and dry contaminants from bearing cavity

Equipment: Ideal for equipment used in food processing or subjected to frequent wash down where positive oil retention is required. Flooded oil or severe splash retention for gearboxes, motors, pumps, mixers, cooling towers, aerators and custom equipment

Technical Data

Total Eccentricity: 0.003" (0.08 mm)

Shaft Speed: Up to 5,000 fpm (25 m/s)¹

Pressure: 5 psi (0.344 bar)

Temperature Range: -40 to 250 °F (-40 to 121 °C)

Axial Movement: 0.003" (0.08 mm)

Shaft/Bore: Tolerances: ± .002" (± .05 mm) Special designs available

Seal Material

Standard: Proprietary PTFE and SS Sleeve

Optional: Food grade PTFE and SS Sleeve, Anti microbial PTFE and SS Sleeve, FDA 3A PTFE and SS Sleeve

O-Ring Material

Standard: FKM

Optional: NBR, FDA silicone, EPDM, Aflas®

Table 8-36. FS-360 Mounting and Lubrication

	Mounting		Lubrication		
	Position	Grease	Oil	Dry	
Horizontal	Y	Y	Y	Y	Y
Vertical Up	Y*	Y	Y	Y	Y
Vertical Down	Y	Y	Y	Y	Y

* For Vertical Up, contact factory if contaminant level is high.

Dimensions — FS-360 Profile

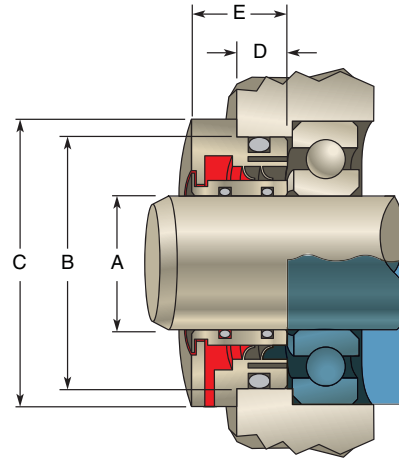

Table 8-37. FSE Standard Dimensions — Inch/Fractional

Type	"A" Shaft Diameter Range Inch	"B" Bore Diameter Range Is Shaft Diameter "A" + Min-Max	"C" Flange Diameter = "B" +	"D" In Bore Depth	"E" Overall Seal Width
FSE	0.500 – 3.000	0.750 – 1.500	0.250	0.313	0.688
FSE	3.001 – 6.000	0.750 – 1.500	0.250	0.375	0.750
FSE	6.001 – 10.000	0.874 – 1.500	0.250	0.438	0.813

Table 8-38. FSM Standard Dimensions — Metric

Type	"A" Shaft Diameter Range Metric	"B" Bore Diameter Range Is Shaft Diameter "A" + Min-Max	"C" Flange Diameter = "B" +	"D" In Bore Depth	"E" Overall Seal Width
FSM	13.0 – 76.0	19.0 – 40.0	6.0	8.0	17.0
FSM	76.1 – 152.0	19.0 – 40.0	6.0	9.0	18.0
FSM	152.1 – 250.0 ²	24.0 – 40.0	6.0	11.0	20.0

¹ Contact factory for speeds over 3,000 fpm (15 m/s).

² Contact factory for requirements outside of standard dimensions listed above. Note: Cross-Section = (Bore – Shaft) / 2

Important: For a listing of popular sizes, see **Appendix F**.



03/28/06



ProTech™ Bearing Isolators

FN-360 Profile

Catalog EPS 5350/USA

FN-360 — Non-flanged Flooded Design

Retain: Grease, oil splash, oil mist or oil flooded

Exclude: Heavy water spray and dry contaminants from bearing cavity

Equipment: Ideal for equipment used in food processing or subjected to frequent wash down where positive oil retention is required. Flooded oil or severe splash retention for gearboxes, motors, pumps, mixers, cooling towers, aerators and custom equipment

Technical Data

Total Eccentricity: 0.003" (0.08 mm)

Shaft Speed: Up to 5,000 fpm (25 m/s)¹

Pressure: 5 psi (0.344 bar)

Temperature Range: -40 to 250 °F (-40 to 121 °C)

Axial Movement: 0.003" (0.08 mm)

Shaft/Bore: Tolerances: ± .002" (± .05 mm) Special designs available

Seal Material

Standard: Proprietary PTFE and SS Sleeve

Optional: Food grade PTFE and SS Sleeve, Anti microbial PTFE and SS Sleeve, FDA 3A PTFE and SS Sleeve

O-Ring Material

Standard: FKM

Optional: NBR, FDA silicone, EPDM, Aflas®

Table 8-39. FN-360 Mounting and Lubrication

	Mounting		Lubrication		
	Position	Grease	Oil	Dry	
Horizontal	Y	Y	Y	Y	
Vertical Up	Y*	Y	Y	Y	
Vertical Down	Y	Y	Y	Y	

* For Vertical Up, contact factory if contaminant level is high.

Dimensions — FN-360 Profile

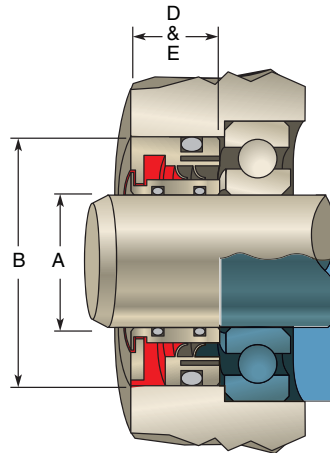

Table 8-40. FNE Standard Dimensions — Inch/Fractional

Type	"A" Shaft Diameter Range Inch	"B" Bore Diameter Range Is Shaft Diameter "A" + Min-Max	"C" In Bore Depth
FNE	0.500 – 3.000	0.750 – 1.500	0.591
FNE	3.001 – 6.000	0.750 – 1.500	0.591
FNE	6.001 – 10.000	0.874 – 1.500	0.630

Table 8-41. FNM Standard Dimensions — Metric

Type	"A" Shaft Diameter Range Metric	"B" Bore Diameter Range Is Shaft Diameter "A" + Min-Max	"C" In Bore Depth
FNM	12.7 – 76.2	19.0 – 40.0	15.0
FNM	76.3 – 152.4	19.0 – 40.0	15.0
FNM	152.5 – 254.0 ²	22.2 – 40.0	16.0

¹ Contact factory for speeds over 3,000 fpm (15 m/s).

² Contact factory for requirements outside of standard dimensions listed above. Note: Cross-Section = (Bore – Shaft) / 2

Important: For a listing of popular sizes, see **Appendix F**.

03/28/06



FlexiLip™

Introduction

Catalog EPS 5350/USA

Contents

Engineering	9-3
Materials	9-6
Product Offering	9-9



FlexiLip

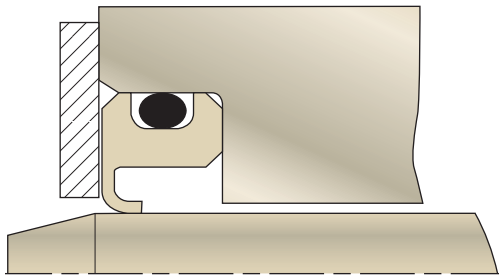

FlexiLip Application

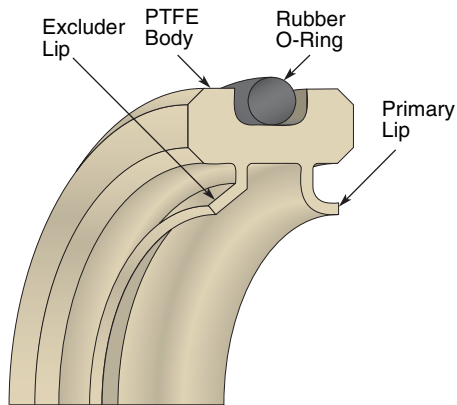

FlexiLip Components

What Is a FlexiLip and How Does It Work?



The Parker FlexiLip is a rotary lip seal that features an ID lip that seals dynamically on a shaft and an elastomeric O-ring on its OD to seal statically in a bore. Since the lip is not spring energized, the radial lip contact forces are lower than a rotary FlexiSeal, which allows the seal to function at much higher surface speeds (up to 5000 sfpm [25 m/s]).

The seals are manufactured from a wide variety of PTFE composites and other machinable plastic materials. Standard O-ring choices are fluorocarbon, silicone, nitrile and EPDM. This broad foundation of standard O-ring and PTFE materials can be tailored to suit nearly all applications. Standard and Non-standard FlexiLip profiles are precision machined to fit inch-fractional and metric gland geometries. The FlexiLip design is extremely versatile because the seal is machined from a molded PTFE sleeve. Standard tooling and programs are used to manufacture seals efficiently by eliminating setup and programming time. FlexiLip seals are used in demanding applications where the operating conditions exceed the capabilities of elastomeric seals.

Applications

The FlexiLip's versatility makes it suitable for a wide range of applications including:

- | | | |
|---------------|--------------|------------|
| • Motors | • Cryogenics | • Blowers |
| • Gear Boxes | • Rolls | • Spindles |
| • Pumps | • Extruders | • Robotics |
| • Bearings | • Valves | • Mixers |
| • Compressors | | |

Markets

FlexiLip's low tooling costs and rapid prototyping capability make the FlexiLip an appealing choice for customers in a variety of markets including:

- | | | |
|--------------------|-------------------|-------------------|
| • Aerospace | • Medical | • Food Processing |
| • Automotive | • Pharmaceutical | • Electronic |
| • Chemical Process | • Military | • Oil & Gas |
| • Appliances | • Heavy Machinery | • Steel Mill |
| • Machine Tools | • Pulp & Paper | • Plastics |
| • Marine | • Hydraulic | |



03/28/06



Part Number Nomenclature — FlexiLip

Table 9-1. FlexiLip Part Number Nomenclature

English

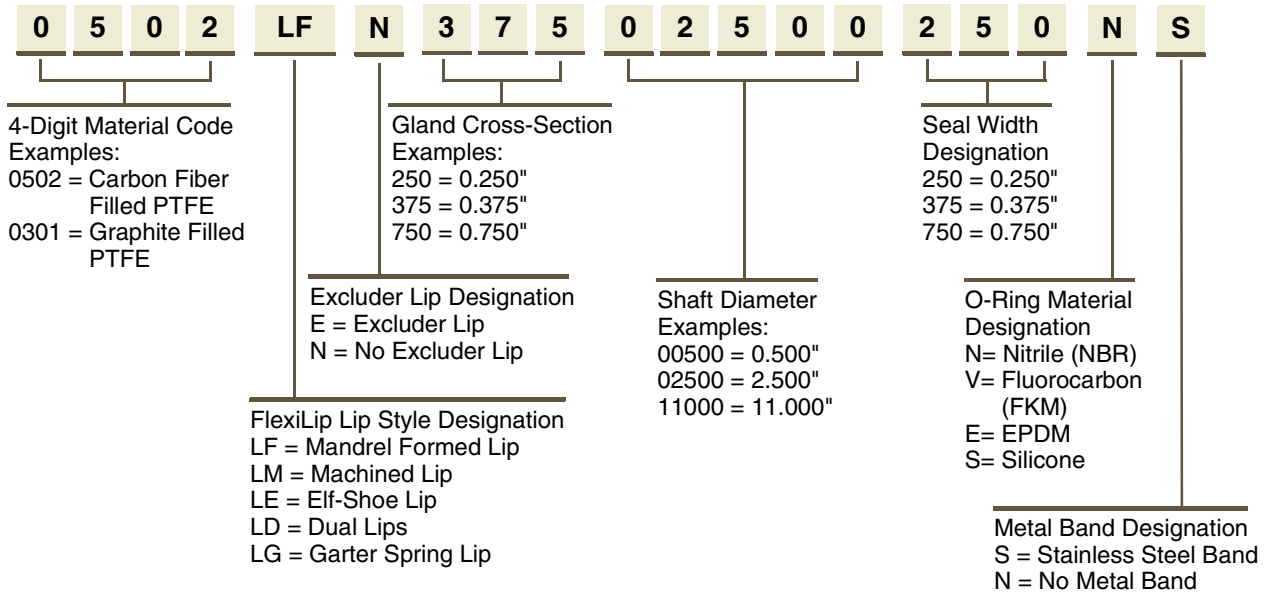

Metric

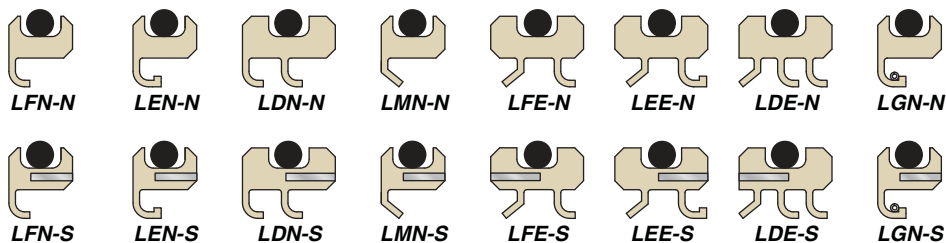
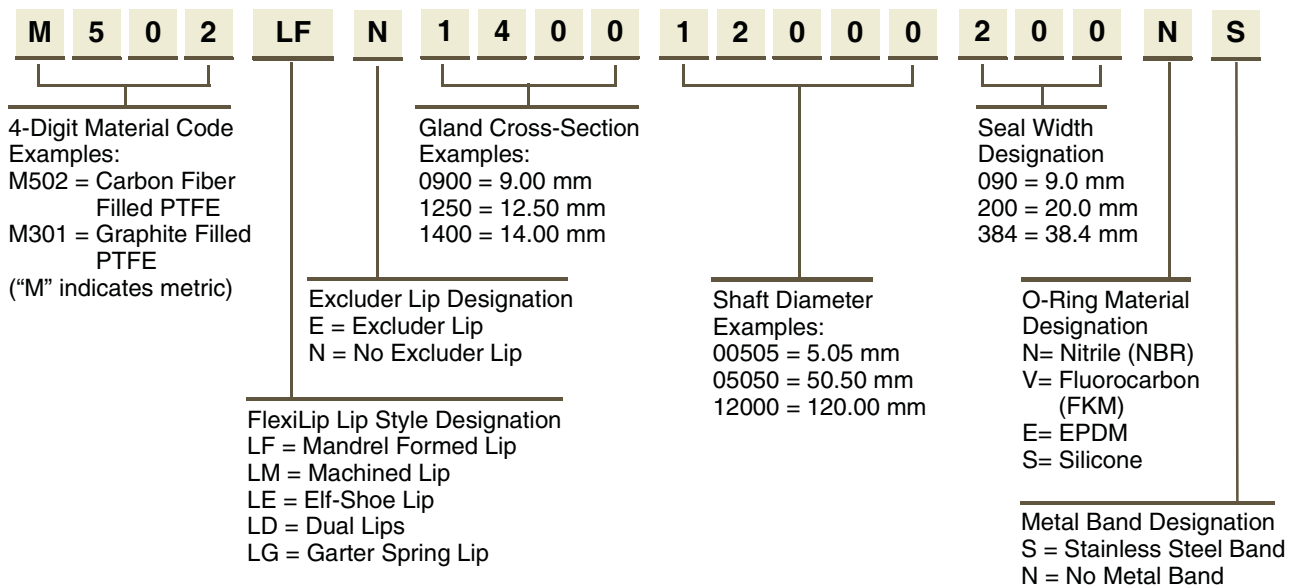

03/28/06

Choosing the Right Design

From Gland Dimensions to Part Number

Step 1 — Choose profile. Choose the best profile for your application from the decision tree and table on **Pages 9-9** through **9-11**, and place the 4-character profile description into the part number as shown here in this example.

Choice: LEN-S Profile

XXXX**LEN**XXXXXXXXXXXX**S**



Step 2 — Choose material. Choose the best material for the application and place the 4-digit material code into the part number as shown here:

Choice: 0502 — Carbon Fiber Filled PTFE

0502LENXXXXXXXXXXXX

Step 3 — Choose O-ring material. Choose the best O-ring material after considering the chemicals and temperatures it will be exposed to. Consult the *Parker O-Ring Handbook* (ORD 5700A/US section II) as a general reference and choose the most appropriate material family. Place in the part number as shown here:

Choice: Fluorocarbon O-ring (V code)

0502LENXXXXXXXXXXXX**V**S

Step 4 — Fill in the size portion of the part number. Choose the optimal size of the part based on the limitations of the cross-section and diameter (**Page 9-11**) and place into the part number as shown:

Choice: 1.500" shaft x 2.000" bore x 0.500" bore depth

Calculate Radial Cross-Section and input into part number:

$$(2.000" \text{ Bore} - 1.500" \text{ Shaft}) / 2 = 0.250"$$

0502LEN**250**XXXXXXXXXVS

Input shaft diameter into part number:

0502LEN250**01500**XXXXVS

Find minimum seal width from **Page 9-11** and input into part number. Minimum seal width is always the most economical, but you can choose any width between the minimum recommended seal width and the actual bore depth. In this case you could choose any width between 0.250" and 0.500".

Minimum seal width = 0.250"

0502LEN25002000**250**VS

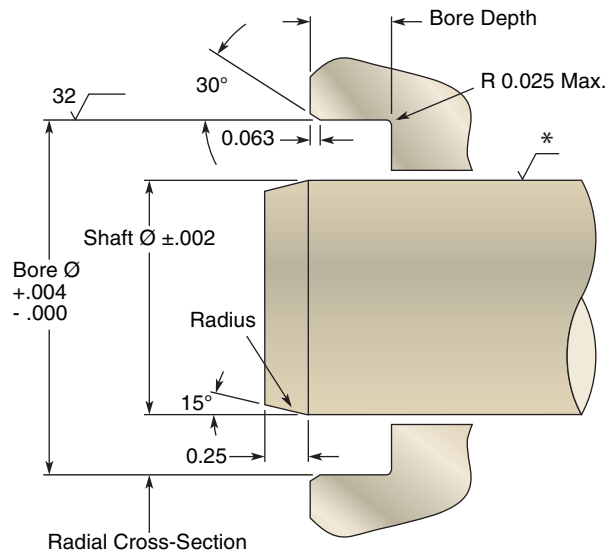

*Note: For more specific information on surface finish refer to **Table 2-5** on **Page 2-21**.

From Part Number to Gland Dimensions

Step 1 — Extract shaft dimensions from part number:

0502LEN375**02125**736VS

02125 = 2.125" shaft diameter

For 2.125" shaft tolerance = ±.002" from drawing above.

Step 2 — Extract bore diameter from part number:

0502LEN**37502125**736VS

375 = 0.375" cross-section

bore Ø = shaft Ø + (2 x cross-section)

bore Ø = 2.125" + (2 x 0.375) = 2.875"

For 2.875" bore, tolerance = +.004/- .000 from drawing above.

Step 3 — Extract bore depth from part number:

0502LEN37502125**736**VS

736 = 0.736" seal height

min. bore depth = seal height + 0.010"

min. bore depth = 0.736" + 0.010" = 0.746"



Table 9-2. Part Number Examples

	Profile	Shaft Dia.	Bore Dia.	Min. Bore Depth	O-ring Material
0204LEN43703624375EN	LEN-N	2.750 ± .002"	3.624 + .004/- .000"	0.385"	EPDM
0301LDE50105550525VS	LDE-S	4.548 ± .002"	5.550 + .004/- .000"	0.535"	Fluorocarbon
M127LGN09106620140SS	LGN-S	48.0 ± .08 mm	66.2 + .16/-0 mm	14.25 mm	Silicone
M615LFE12516000200NN	LFE-N	135.0 ± .0 8 mm	160.0 + .16/-0 mm	20.25 mm	Nitrile

FlexiLip Installation

Proper installation tools and techniques must be used to install the seal without damaging the critical sealing areas.

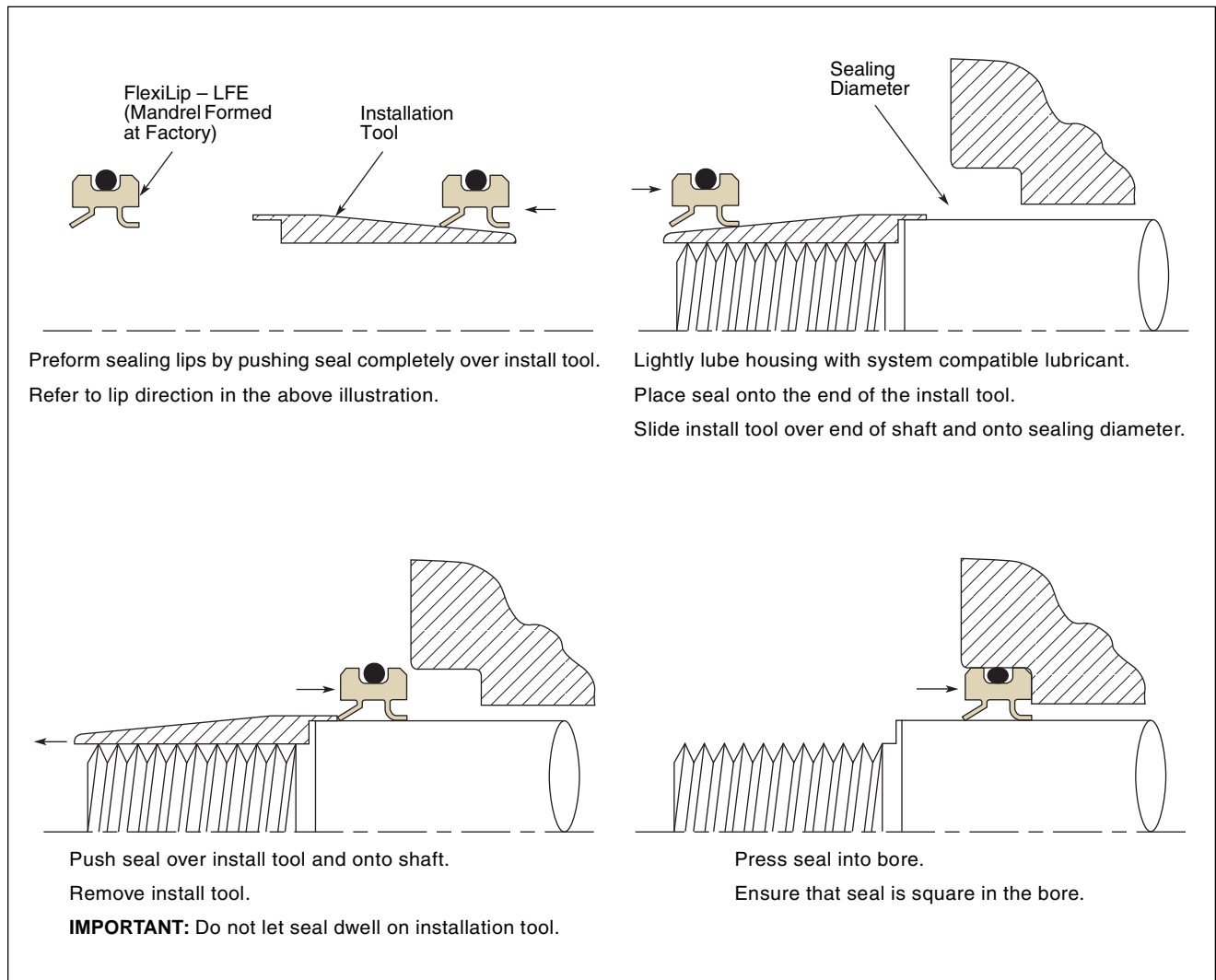

Figure 9-1. FlexiLip Installation

03/28/06

FlexiLip Installation Tool

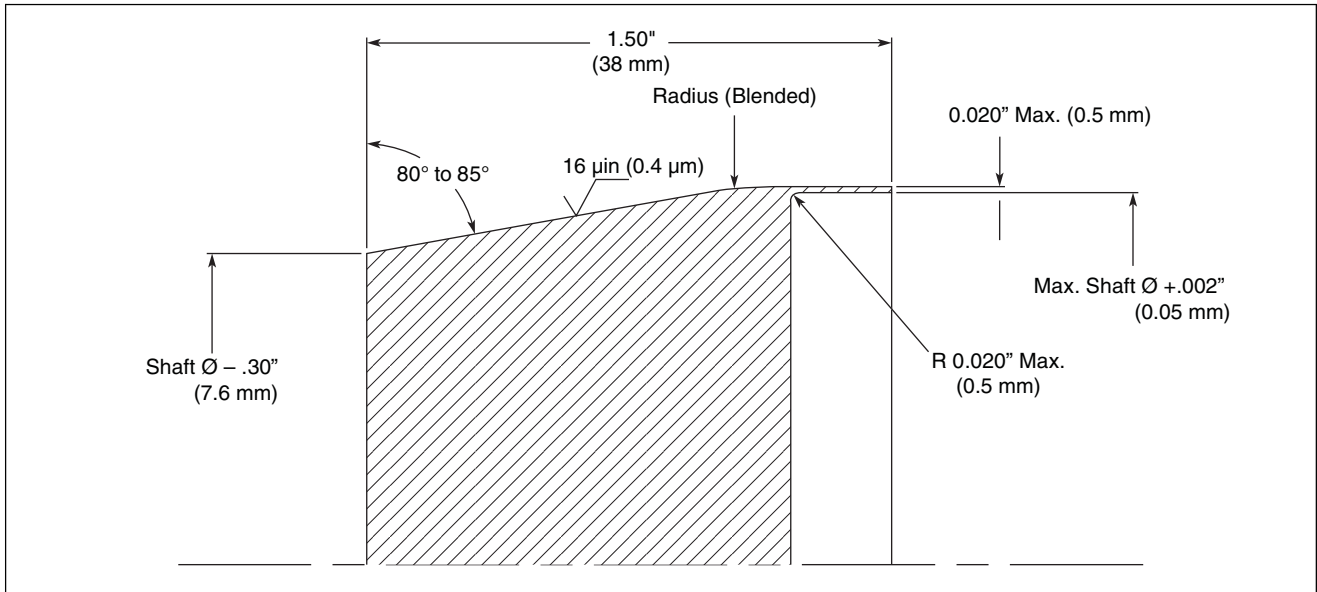
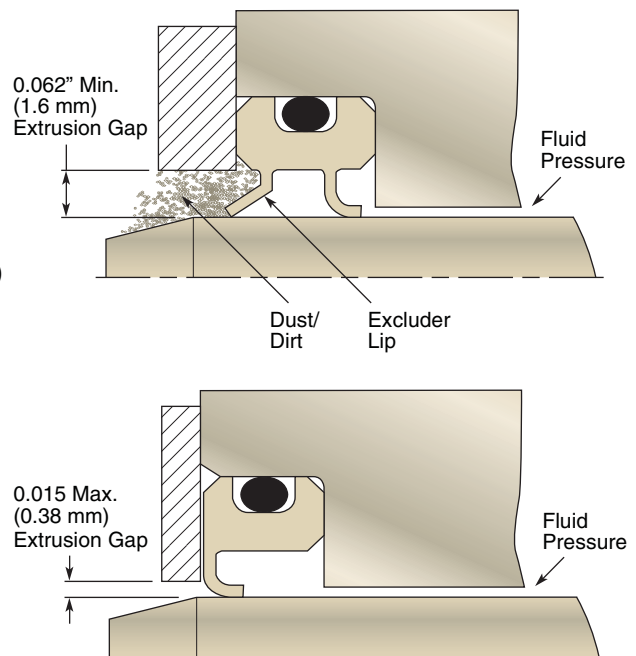

Figure 9-2. Installation Tool Dimensions

Hardware Notes

Each FlexiLip profile is given a standard pressure rating in **Table 9-4** to aid the user in the selection of the most appropriate profile for an application. These pressure ratings are based on the assumptions that there is a large extrusion gap as shown in the first illustration and that the temperature at the gap is less than 300 °F (149 °C). Tightening the extrusion gap to around 0.015" (0.38 mm) on non-excluder lip profiles can double or triple the pressure rating for the seal. The extrusion gap for profiles with excluder lips must be at least 0.062" (1.6 mm) to allow the excluder lip to extend beyond the outside of the seal envelope if necessary. Reducing the extrusion gap does not improve the pressure rating of a seal with an excluder lip.



FlexiLip™ Materials

Catalog EPS 5350/USA

Common Materials Used in this Product

The most popular fillers for FlexiLip products are graphite, fiberglass/molybdenum disulfide, carbon fiber and mineral.



A complete listing of material properties and limitations appears on **Pages 9-7 and 9-8**. Feel free to contact the EPS division PTFE Engineering Team at (801) 972-3000 for more guidance on material selection.

0301 — Graphite Filled

Since graphite is often used as a lubricant, it does not significantly increase the coefficient of friction of PTFE when used as a filler. The low friction allows the compound to be used when both shaft speed and pressure are high. Graphite also is chemically inert which enables its use in corrosive medias.

0615 — Proprietary Low Wear PTFE

This proprietary filled PTFE offers low wear and friction properties, used in general applications where long life is required. Not recommended for applications with abrasive media.

0204 — Molybdenum Disulfide and Fiberglass Filled

Molybdenum disulfide increases the hardness of the seal surface while decreasing friction. It is normally used in small proportions combined with other fillers such as glass. MoS₂ is also inert towards most chemicals.

0512 — Carbon Fiber Filled

Carbon fiber lowers creep, increases flex and compressive modulus and raises hardness. Coefficient of thermal expansion is lowered and thermal conductivity is higher for compounds of carbon fiber filled PTFE. Ideal for automotive applications in shock absorbers and water pumps.

0127 — Mineral Filled — 3A Sanitary Approved

Mineral is ideal for high temperatures and offers low abrasion to soft surfaces. PTFE with this filler can easily be qualified to FDA and other food-grade specifications like 0127 and 0128.

Table 9-3. FlexiLip, FlexiCase and FlexiSeal PTFE Materials — Typical Physical Properties

Parker Material Code	Material	Color	Typical Applications & Description	Service Temperature Range	Tensile Strength in psi at Break (bar)	Elongation in %	Hardness Shore D
0100	Virgin PTFE	White	Excellent for cryogenic applications. Good for gases.	-425 to +450 °F -255 to +230 °C	4575 (315)	400	60
0102	Modified PTFE	Turquoise	Lower creep, reduced permeability and good wear resistance.	-320 to +450 °F -195 to +230 °C	4600 (317)	390	60
0120	Mineral Filled PTFE	White	Excellent low abrasion to soft surfaces & improved upper temperature performance	-360 to +550 °F -220 to +290 °C	4070 (281)	270	65
0127	Mineral Filled PTFE — 3A Sanitary Approved	White	FDA and 3A compliant materials for sanitary food and pharmaceutical processing.	-360 to +550 °F -220to +290 °C	2800 (193)	250	66
0128	Mineral Filled PTFE — Antimicrobial	White	FDA material with an antimicrobial agent added to prevent bacterial growth	-360 to +550 °F -220to +290 °C	2800 (193)	250	66
0203	Fiberglass Filled PTFE	Gold	Excellent compressive strength and good wear resistance.	-200 to +575 °F -130 to -300 °C	3480 (240)	190	67
0204	Fiberglass & MolyFilled PTFE	Gray	Excellent for extreme conditions such as high pressure & temperature and for longer wear life on hardened dynamic surfaces.	-200 to +575 °F -130 to -300 °C	3100 (214)	245	62
0301	Graphite Filled PTFE	Black	Excellent for corrosive service. Low abrasion to soft shafts. Good in unlubricated service	-250 to +550 °F -155 to +290 °C	3200 (221)	260	60
0307	Carbon-Graphite Filled PTFE	Black	Excellent wear resistance and reduced creep.	-360 to +575 °F -220 to -300 °C	2250 (155)	100	64
0405	Stainless Steel Filled TFE	Gray	Excellent extrusion resistance at high temperatures and at high temperaute and pressures.	-300 to +600 °F -185 to +315 °C	2200 (152)	190	72
0502	Carbon Fiber Filled PTFE	Brown	Good for strong alkali and hydrofluoric acid. Good in water service.	-200 to +550 °F -130to +290 °C	3200 (221)	312	60
0601	Aromatic Polyester Filled PTFE	Tan	Excellent high temperature capabilities & excellent wear resistance.	-360 to +550 °F -255 to -230 °C	2500 (315)	200	61
0615	Proprietary Low Wear PTFE	Purple	Excellent low wearing material. Kind to soft mating surfaces in the Rb range.	-360 to +550 °F -220 to +290 °C	3470 (239)	200	63
0901	UHMW Polyethylene	Translucent	High wearing plastic for use in abrasive medias. Excellent in water based medias, but restricted chemical and heat resistance	-320 to +200 °F -195 to +95 °C	6000 (414)	325	67
0913	Hytrel®* unlubricated Thermoplastic Elastomer	Black	Excellent in gases and most hydraulic fluids. Good abrasion resistance with high wear properties.	-80 to +275 °F -60to +135°C	5800 (400)	500	55

9

*Hytrel® is a registered trademark of DuPont.

Table 9-3. FlexiLip, FlexiCase and FlexiSeal PTFE Materials — Typical Physical Properties (Continued)

Parker Material Code	Coefficient of Friction	Thermal Conductivity in W/mK	Coefficient of Thermal Expansion in/in/°F x 10 ⁻⁵ at 203 °F (mm/mm/°C x 10 ⁻⁵ at 95 °C)	Permanent Deformation Under Load 70 °F (21 °C) 2000 psi (138 bar) in %	Chemical Compatibility Rating	Wear Resistance Rating	High Pressure Extrusion Resistance Rating	FDA/NSF Compliant	Minimum Rotary Shaft Hardness*
0100	0.05 – 0.10	0.30	11.0 (19.8)	7.0	5	1	1	Yes	25Rc
0102	0.05 – 0.10	0.29	11.0 (19.8)	6.9	5	2	2	Yes	25Rc
0120	0.08 – 0.12	0.23	11.0 (19.8)	4.2	5	3	4	Yes	45Rc
0127	0.07 – 0.10	0.30	11.0 (19.8)	5.5	5	3	4	Yes	45Rc
0128	0.07 – 0.10	0.30	11.0 (19.8)	5.3	5	3	4	Yes	45Rc
0203	0.08 – 0.12	0.27	10.0 (18.0)	6.0	5	5	5	No	60Rc
0204	0.08 – 0.12	0.28	11.0 (19.8)	6.0	5	4	4	No	45Rc
0301	0.07 – 0.09	0.39	11.0 (19.8)	3.5	5	4	3	No	25Rc
0307	0.08 – 0.11	0.35	8.0 (14.4)	2.5	5	4	4	No	60Rc
0405	0.30 – 0.34	0.40	8.0 (14.4)	3.6	5	4	5	No	60Rc
0502	0.09 – 0.12	0.31	13.0 (23.4)	1.8	4	5	5	No	60Rc
0601	0.09 – 0.13	0.32	9.0 (16.2)	5.5	4	4	4	No	25Rc
0615	0.09 – 0.12	0.30	9.0 (16.2)	3.2	5	5	3	No	25Rc
0901	0.17 – 0.22	—	11.0 (19.8)	7.1	3	5	5	Yes	25Rc
0913	0.18 – 0.30	0.16	7.2 (13.0)	—	2	4	5	No	25Rc

Note: We emphasize that this tabulation should be used as a guide only.

It is based primarily on laboratory and service tests, but does not take into account all variables that can be encountered in actual use. Therefore, it is always advisable to test the material under actual service conditions before specification. If this is not practical, tests should be devised that simulate service conditions as closely as possible.

Parker EPS Division also offers unique material blends and recipes along with a wide variety of other PTFE filler combinations and colors to enhance seal performance in the most extreme application needs. For guidance on material selection for extreme applications, please contact an EPS Division PTFE Application Engineer at 801-972-3000.

* Since surface speed, pressure, under-lip temperature, media lubricity and abrasiveness significantly affect the level of shaft hardness needed in an application, the user should upgrade from these recommended minimums as the application becomes more severe.

03/28/06



FlexiLip™ Product Offering

Catalog EPS 5350/USA

The key application considerations that help in the selection of the right FlexiLip profile are operating temperature, media abrasiveness, pressure, external contamination, friction requirements, shaft diameter and Total Indicator Runout (TIR).

Total Indicator Runout (TIR) is how far the shaft is misaligned with the bore during rotation. This is fully characterized in the general engineering section on **Page 2-25**. Only one FlexiLip profile is able to handle continuous service with runout conditions up to 0.020" (0.5 mm); the LGN-N (or the LGN-S with the steel band). Keep in mind that the faster a shaft spins, the less TIR the seal can withstand.

If the temperatures are extreme or if the shaft is over 4 inches in diameter, Parker recommends using a profile with a stainless steel band inserted into the side for dimensional stability during thermal cycling. This standard design can be called out by switching the "-N" for a "-S" in the profile code (and the part number).

These decision trees are to be used as an engineering guide only. Often several other parameters must be considered to optimize seal design. Contact Parker's PTFE Engineering Team for confirmation of your choice or further recommendations. Parker also recommends that any seal be tested in the application conditions before releasing for production.

Decision Trees

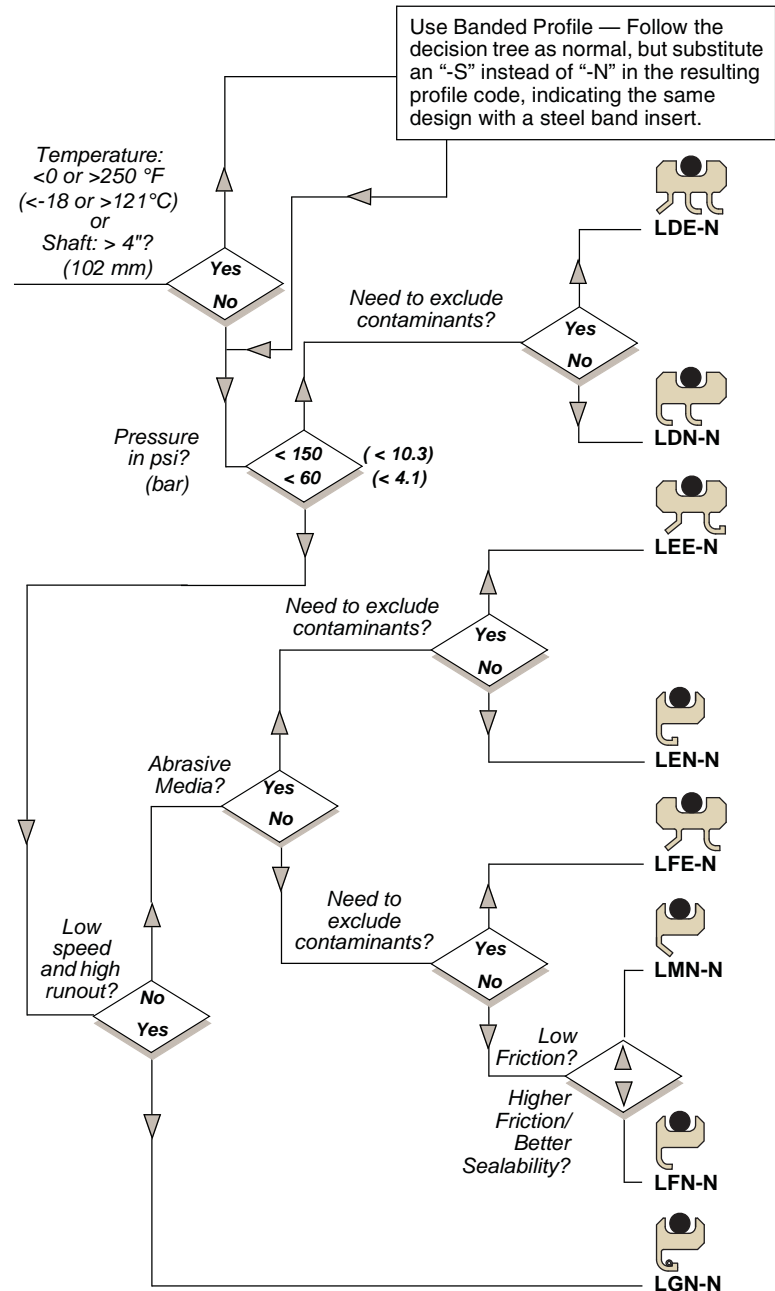



03/28/06

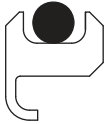

Profiles

Table 9-4. Product Profiles

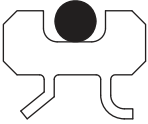
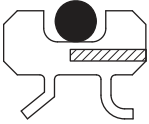
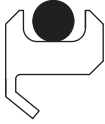
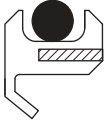
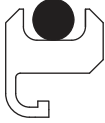
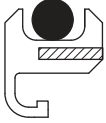
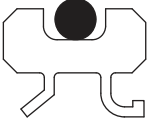
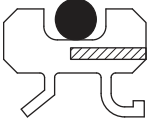
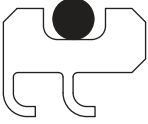
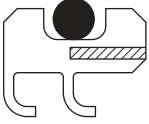
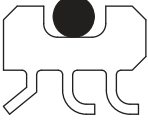
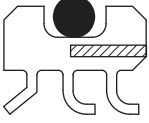
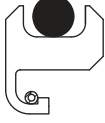
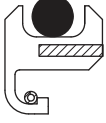
Standard Profile	Banded Profile*	Features	Recommended Applications
LFN-N 	LFN-S 	Formed Primary Lip	Multipurpose Seal
LFE-N 	LFE-S 	Formed Primary Lip w/ Excluder Lip	Multipurpose Seal
LMN-N 	LMN-S 	Machined Primary Lip	Low Friction
LEN-N 	LEN-S 	Elf-Toe Primary Lip	Abrasive Media
LEE-N 	LEE-S 	Elf-Toe Primary Lip w/ Excluder Lip	Abrasive Media
LDN-N 	LDN-S 	Dual Primary Lips	Oil Seal — Flooded, Severe Splash
LDE-N 	LDE-S 	Dual Primary Lips w/ Excluder Lip	Oil Seal — Flooded, Severe Splash
LGN-N 	LGN-S 	Primary Lip Energized with Garter Spring	Slow, high runout applications up to 0.020" (0.51 mm) TIR

*Metal Banded — 301 Stainless Steel. For use when temperature is <0 or >250 °F (<-18 or >121 °C) or shaft diameter \geq 4.000" (102 mm).

**Consult engineering for shaft diameters that are outside the range of our standards.

***Seals that are retained with an extrusion gap smaller than 0.020" (0.5 mm) will go to higher pressures than listed. Consult EPS Division Engineering.

03/28/06



Shaft Diameter**	Cross-Section Min.	Width Min. (mm)	Pressure Max.***	Surface Speed Max.	Friction Rating (1 – 5 with 1 Best)
0.625 to 12" (16 to 305 mm)	Standard 0.250" Banded 0.312" (6 mm) (8 mm)	Standard 0.250" (6) Banded 0.312" (8)	60 psi (4.1 bar)	5000 sfpm (25 m/s)	2
0.750 to 12" (19 to 305 mm)	Standard 0.250" Banded 0.375" (6 mm) (9.5 mm)	Standard 0.312" (8) Banded 0.375" (9.5)	60 psi (4.1 bar)	5000 sfpm (25 m/s)	3
0.750 to 12" (19 to 305 mm)	Standard 0.250" Banded 0.312" (6 mm) (8 mm)	Standard 0.250" (6) Banded 0.312" (8)	30 psi (2 bar)	6000 sfpm (30 m/s)	1
0.750 to 12" (19 to 305 mm)	Standard 0.250" Banded 0.375" (6 mm) (9.5 mm)	Standard 0.250" (6) Banded 0.312" (8)	60 psi (4.1 bar)	5000 sfpm (25 m/s)	3
0.750 to 12" (19 to 305 mm)	Standard 0.250" Banded 0.375" (6 mm) (9.5 mm)	Standard 0.312" (8) Banded 0.375" (9.5)	60 psi (4.1 bar)	5000 sfpm (25 m/s)	4
0.750 to 12" (19 to 305 mm)	Standard 0.250" Banded 0.375" (6 mm) (9.5 mm)	Standard 0.312" (8) Banded 0.312" (8)	150 psi (10.3 bar)	5000 sfpm (25 m/s)	4
0.750 to 12" (19 to 305 mm)	Standard 0.250" Banded 0.437" (6 mm) (11 mm)	Standard 0.437" (11) Banded 0.437" (11)	150 psi (10.3 bar)	5000 sfpm (25 m/s)	5
0.750 to 12" (19 to 305 mm)	Standard 0.250" Banded 0.312" (6 mm) (8 mm)	Standard 0.250" (6) Banded 0.312" (8)	60 psi (4.1 bar)	2000 sfpm (10 m/s)	4



03/25/06



FlexiCase™

Introduction

Catalog EPS 5350/USA

Contents

Engineering	10-3
Materials	10-6
Product Offering	10-7



FlexiCase

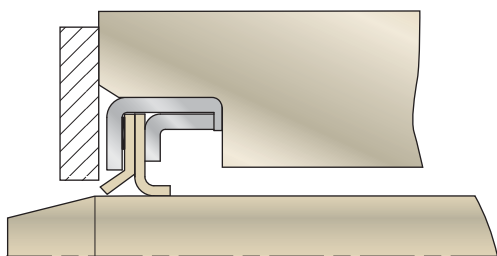

FlexiSeal Application

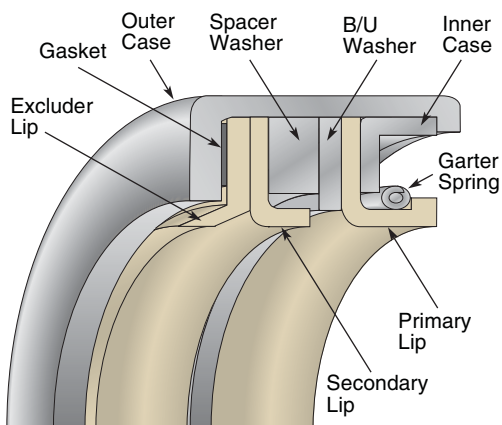

FlexiCase Components



The Parker FlexiCase is a rotary lip seal that features an ID lip that seals dynamically on a shaft and metal casing on its OD to seal statically press-fit into a bore. A gasket is sandwiched between layers of sealing lips and the can to seal off the potential leak path. Since the lip is not spring-energized, the radial lip contact forces are lower than a rotary FlexiSeal, which allows the seal to function at much higher surface speeds (up to 10,000 sfpm [51 m/s]).

The seals are manufactured from a wide variety of PTFE composites and other machinable plastic materials. Standard gasket choices are fluorocarbon, nitrile, EPDM and Armstrong reinforced paper. Users can choose between stainless steel, cold-rolled steel, zinc plated cold-rolled steel and aluminum. This broad foundation of standard gasket, metal and PTFE materials can be tailored to suit nearly all applications. Standard and Nonstandard FlexiCase profiles are precision machined to fit inch and metric gland geometries. FlexiCase seals are used in demanding applications where the operating conditions exceed the capabilities of elastomeric seals.

Applications

The FlexiCase's versatility makes it suitable for a wide range of applications including:

- | | | |
|--------------|---------------|------------|
| • Motors | • Compressors | • Blowers |
| • Gear Boxes | • Cryogenics | • Spindles |
| • Pumps | • Extruders | • Robotics |
| • Bearings | • Valves | • Mixers |

Markets

FlexiCase's low costs and high production capability make the FlexiCase an appealing choice for customers in a variety of markets including:

- | | | |
|--------------------|-------------------|-------------------|
| • Aerospace | • Medical | • Food Processing |
| • Automotive | • Pharmaceutical | • Electronic |
| • Chemical Process | • Military | • Oil & Gas |
| • Appliances | • Heavy Machinery | • Steel Mill |
| • Machine Tools | • Pulp & Paper | • Plastics |
| • Marine | • Hydraulic | |

10

03/28/06



Part Number Nomenclature — FlexiCase

Table 10-1. FlexiCase Part Number Nomenclature

English

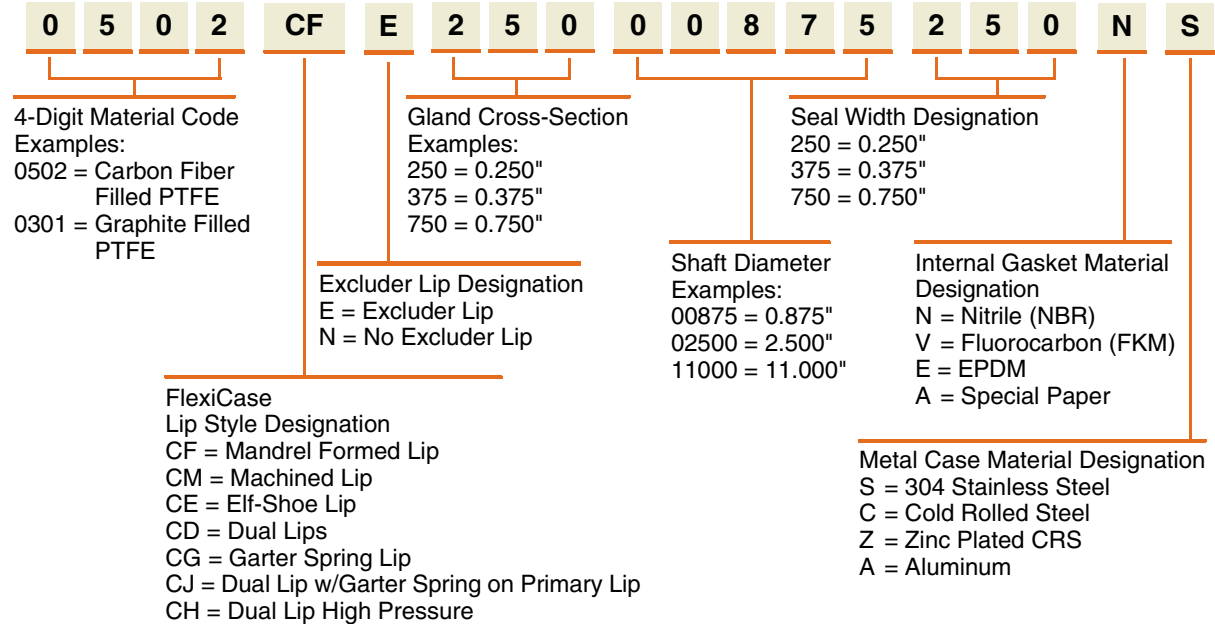

Metric

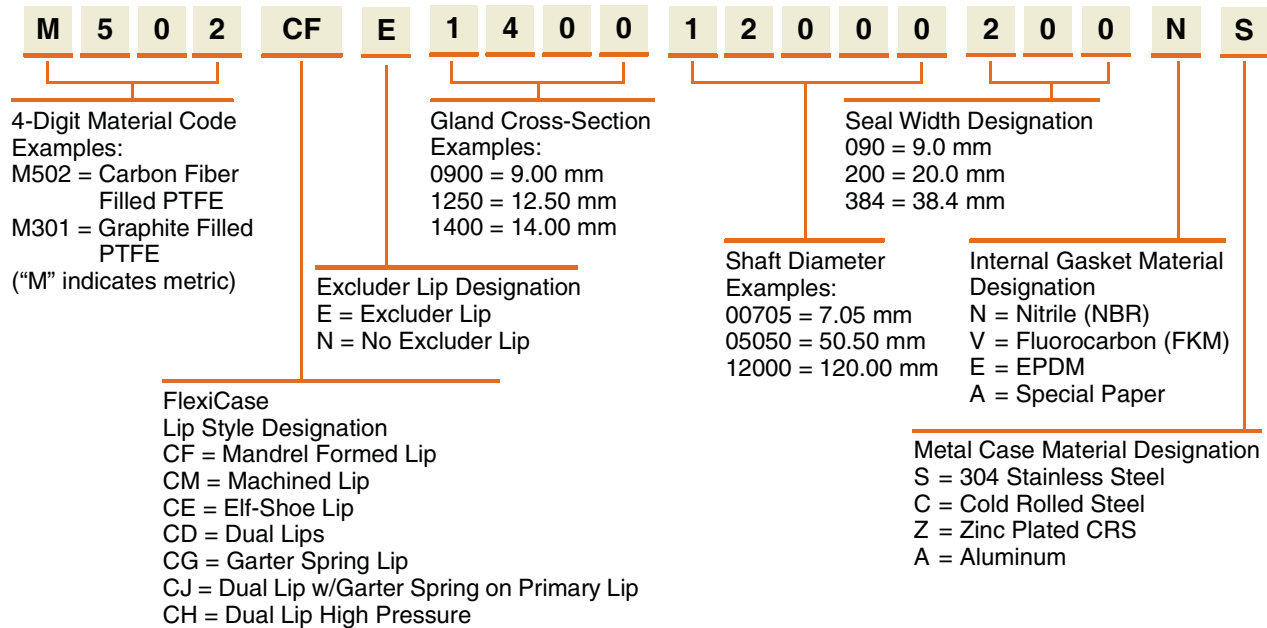

10

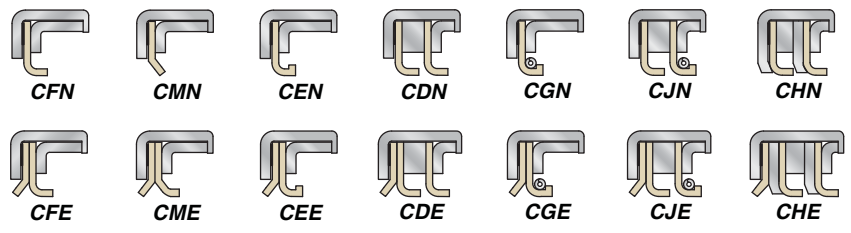

03/28/06

Choosing the Right Design

From Gland Dimensions to Part Number

Step 1 — Choose profile. Choose the best profile for your application from the decision tree and table on **Pages 10-7 through 10-9**, and place the 3-character profile description into the part number as shown here in this example.

Choice: CFE profile

XXXX**CFE**XXXXXXXXXXXX

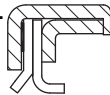

Step 2 — Choose material. Choose the best material for the application and place the 4-digit material code into the part number as shown here:

Choice: 0301 — Graphite Filled PTFE

0301CFEXXXXXXXXXXXX

Step 3 — Choose gasket material. Choose the best gasket material after considering the chemicals and temperatures it will be exposed to. Consult the *Parker O-Ring Handbook* (ORD 5700A/US Section II) as a general reference and choose the most appropriate material family. Place in the part number as shown here:

Choice: Nitrile gasket (N code)

0301CFEXXXXXXXXXXXX**N**X

Step 4 — Choose metal can material. Consult **Page 10-6** and choose the best fit for the application. Place the choices in the part number as shown here:

Choice: Cold rolled steel can (C code)

0301CFEXXXXXXXXXXXX**C**

Step 5 — Fill in the size portion of the part number. Choose the optimal size of the part based on the limitations of the cross-section and diameter (**Pages 10-8 to 10-9**) and place into the part number as shown:

Choice: 2.250" shaft x 3.125 ± .0015 bore Ø x 0.500" bore depth

Calculate Radial Gland Cross-Section and input into part number:

$(3.125" \text{ Bore} - 2.250" \text{ Shaft}) \div 2 = 0.4375"$, rounds to 0.438"

0301CFE**438**XXXXXXXXXNC

Input shaft diameter into part number:

0301CFE438**02250**XXXXNC

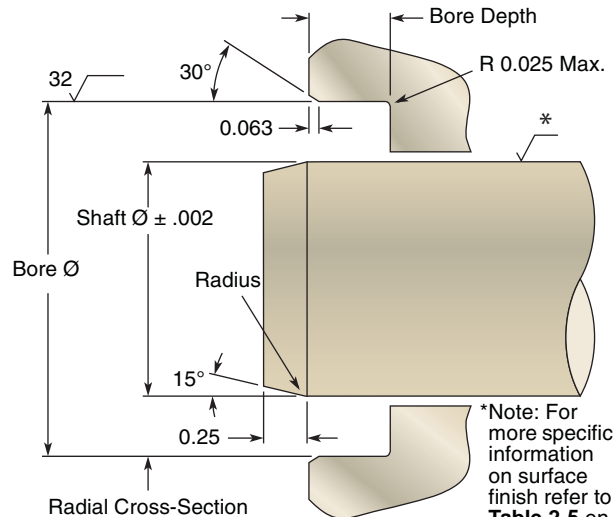

Step 6 — Find minimum seal width from **Pages 10-8 to 10-9** and input into part number. Minimum seal width is always the most economical, but you can choose any width between the minimum recommended seal width and the actual bore depth. In this case you could choose any width between 0.200" and 0.500".

Minimum seal width = 0.200"

0301CFE43802250**200**NC

From Part Number to Gland Dimensions

Step 1 — Extract shaft dimensions from part number:

0301CGN500**01125**437VS

01125 = 1.125" shaft diameter

Apply tolerance according to **Table 10-2**

For 1.125" shaft tolerance = ±.003" plunge grind shaft to achieve low surface finish

Step 2 — Extract bore diameter from part number:

0301CGN**50001125**437VS

500 = 0.500" cross-section

Bore Ø = Shaft Ø + (2 x cross-section)

Bore Ø = 1.125" + (2 x .500) = 2.125"

Apply tolerance according to **Table 10-2**

For 2.125" bore, tolerance = ±.001"

Step 3 — Extract bore depth from part number:

0301CGN50001125**437**VS

437 = 0.437" seal height

min. bore depth = seal height

min. bore depth = 0.437"

03/28/06

Table 10-2. Bore Tolerance

Bore Ø	Bore Tolerance	Max. Housing Radius	Metric Bore Ø	Bore Tolerance	Max. Housing Radius
Up to 3"	±.001"	0.045"	Up to 75 mm	±.025"	1.14 mm
3.001 to 6"	±.0015"	0.054"	75.01 to 150 mm	±.038"	1.37 mm
6.001 to 8"	±.002"	0.072"	150.01 to 200 mm	±.050"	1.83 mm
8.001 to 9"	±.002"	0.090"	200.01 to 230 mm	±.050"	2.29 mm
9.001 to 10"	±.002"	0.125"	230.01 to 254 mm	±.050"	3.18 mm

Table 10-3. Part Number Examples

	Profile	Shaft Ø	Bore Ø	Min. Bore Depth	Gasket Material
0204CEN43702750375VCN	CEN	2.750 ± .002"	3.624 ± .0015"	0.385"	FKM
0301CJE50104548525NSP	CJE	4.548 ± .002"	5.550 ± .0015"	0.535"	Nitrile
M127CDN091004800140NSZ	CDN	48.0 ± .08 mm	66.2 ± .025 mm	14.25 mm	Nitrile
M615CFE125013500200EAG	CFE	135.0 ± .08 mm	160.0 ± .050 mm	20.25 mm	EPDM

FlexiCase Installation

Proper installation tools and techniques must be used to install the seal without damaging the critical sealing areas.

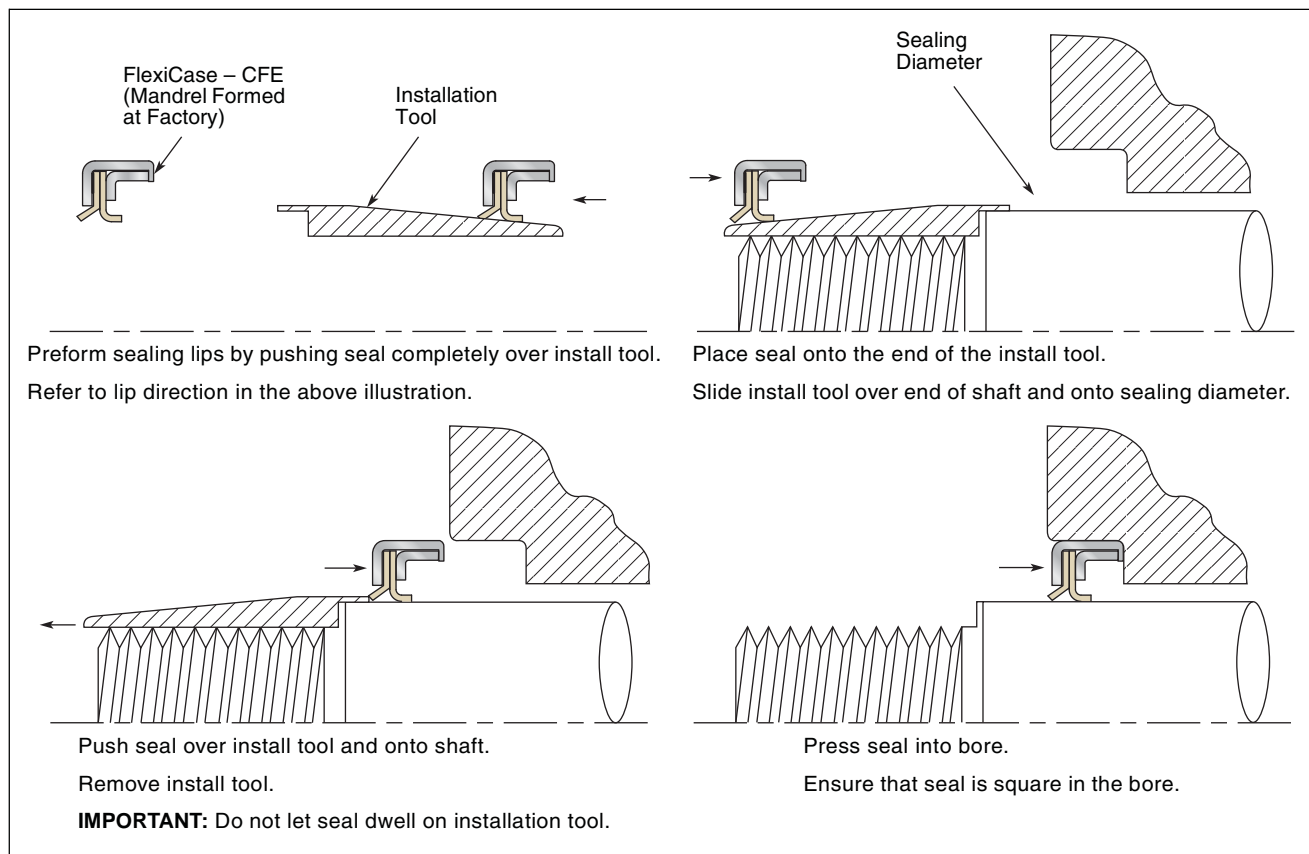

Figure 10-1. FlexiCase Installation

03/28/06

FlexiCase Installation Tool

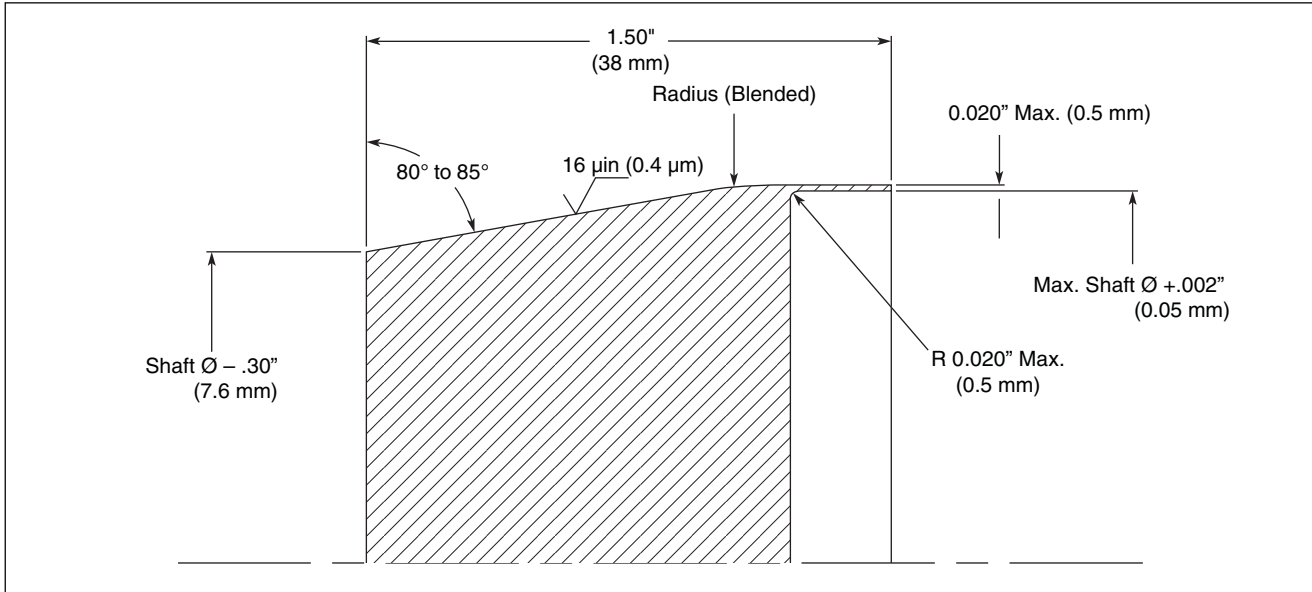

Figure 10-2. Installation Tool Dimensions

Common Materials Used in this Product

The most popular fillers for FlexiCase products are graphite, fiberglass/molybdenum disulfide, carbon fiber and mineral.



A complete listing of material properties and limitations appears on **Pages 9-7 and 9-8**. Feel free to contact the EPS Division PTFE Engineering Team at (801) 972-3000 for more guidance on material selection.

0301 — Graphite Filled

Since graphite is often used as a lubricant, it does not significantly increase the coefficient of friction of PTFE when used as a filler. The low friction allows the compound to be used when both shaft speed and pressure are high. Graphite also is chemically inert which enables its use in corrosive medias.

0615 — Proprietary Low Wear PTFE

This proprietary filled PTFE offers low wear and friction properties, used in general applications where long life is required. Not recommended for applications with abrasive media.

0204 — Molybdenum Disulfide and Fiberglass Filled

Molybdenum disulfide increases the hardness of the seal surface while decreasing friction. It is normally used in small proportions combined with other fillers such as glass. MoS₂ is inert towards most chemicals.

0502 — Carbon Fiber Filled

Carbon fiber lowers creep, increases flex and compressive modulus and raises hardness. Coefficient of thermal expansion is lowered and thermal conductivity is higher for compounds of carbon fiber filled PTFE. Ideal for automotive applications in shock absorbers and water pumps.

0127 — Mineral Filled

Mineral is ideal for improved upper temperatures and offers low abrasion to soft surfaces. PTFE with this filler can easily be qualified to FDA and other food-grade specifications like 0128.

Metal Can Materials

S — Stainless Steel

Good chemical resistance properties up to 600 °F (315 °C). Resists corrosive media up to 400 °F (205 °C).

C — Cold-Rolled Steel

Good in oils and other media friendly to ferrous metals up to 600 °F (315 °C). Excellent value for cost-sensitive projects.

Z — Zinc-Plated Cold-Rolled Steel

Good in oils and mildly corrosive media up to 450 °F (230 °C) . A lower cost alternative to stainless steel.

A — Aluminum

Excellent lightweight, high-strength material. Should be used with aluminum housing when thermal cycling is likely.

FlexiCase™ Product Offering

The key application considerations that help in the selection of the right FlexiCase profile are operating temperature, media abrasiveness, pressure, external contamination, friction requirements, shaft diameter and Total Indicator Runout (TIR). Also see **Table 10-4** for more information on temperatures, pressures, speeds and friction.

Total Indicator Runout (TIR) is how far the shaft is misaligned with the bore during rotation. This is fully characterized in the general engineering section on **Page 2-25**. Four FlexiCase profiles are able to handle continuous service with runout conditions up to 0.010" (0.25 mm) if speeds are slower than 200 RPM: the CGN, CGE, CJN and CJE. Keep in mind that the faster a shaft spins, the less TIR the seal can withstand.





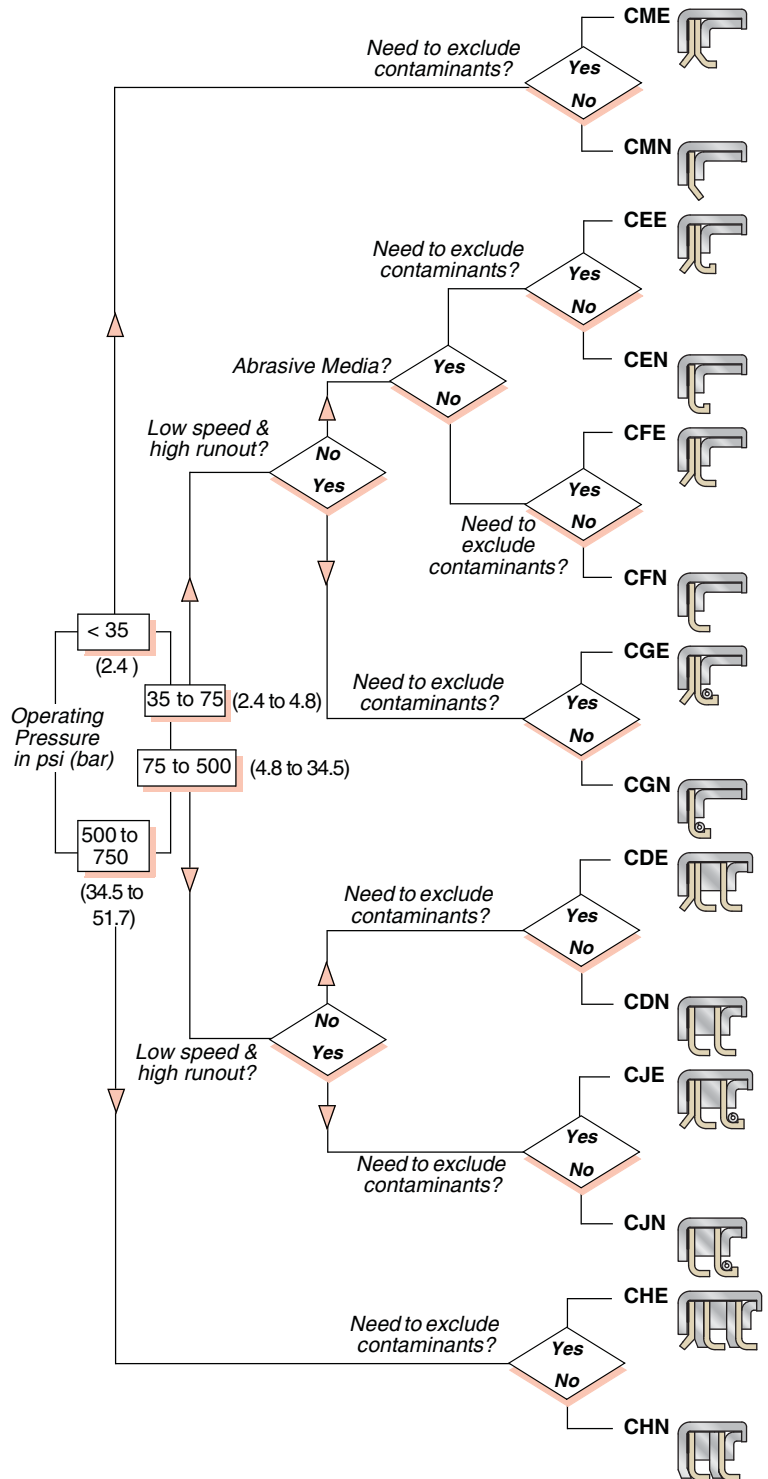

These decision trees are to be used as an engineering guide only. Often several other parameters must be considered to optimize seal design. Contact Parker's PTFE Engineering Team for confirmation of your choice or further recommendations. Parker also recommends that any seal be tested in the application conditions before releasing for production.

Decision Tree

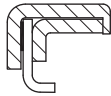
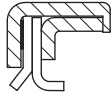
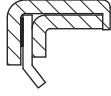

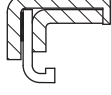
Profiles

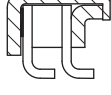
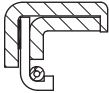
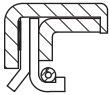
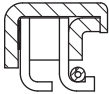

Table 10-4. Product Profiles

Profile	Features	Recommended Applications	Shaft Diameter Limits	Cross-Section Limits	Width Limits*	Pressure Limit at Room Temp.	Surface Speed Max.	Friction Rating
CFN 	Formed Primary Lip	General purpose rotary shaft seal.	0.125" to 6" (3 to 150 mm)	Min 0.250" (50 mm) Max 2" (6 mm)	0.175" (4.5 mm)	250 psi (17 bar)	5000 sfpm (25 m/s)	2
CFE 	Formed Primary Lip w/ Excluder Lip	Ideal to keep oil in and water & dirt out.	0.250" to 6" (6 to 150 mm)	Min 0.250" (50 mm) Max 2" (6 mm)	0.200" (5 mm)	125 psi (9 bar)	5000 sfpm (25 m/s)	3
CMN 	Machined Primary Lip	General purpose rotary shaft seal w/ low breakaway torque.	0.250" to 6" (6 to 150 mm)	Min 0.250" (50 mm) Max 2" (6 mm)	0.175" (4.5 mm)	125 psi (9 bar)	6000 sfpm (30 m/s)	1
CME 	Machined Primary Lip w/ Excluder Lip	Ideal to keep oil in and water & dirt out. Low Breakaway torque.	0.250" to 6" (6 to 150 mm)	Min 0.250" (50 mm) Max 2" (6 mm)	0.200" (5 mm)	125 psi (9 bar)	6000 sfpm (30 m/s)	2
CEN 	Elf-Toe Primary Lip	General purpose rotary shaft seal where shaft runout is 0.005" to 0.010" or abrasive media.	0.125" to 6" (3 to 150 mm)	Min 0.250" (50 mm) Max 2" (6 mm)	0.175" (4.5 mm)	250 psi (17 bar)	5000 sfpm (25 m/s)	2
CEE 	Elf-Toe Primary Lip w/ Excluder Lip	Ideal to keep oil in and water & dirt out where shaft runout is 0.005" to 0.010" or abrasive media.	0.250" to 6" (6 to 150 mm)	Min 0.250" (50 mm) Max 2" (6 mm)	0.200" (5 mm)	125 psi (9 bar)	5000 sfpm (25 m/s)	3
CDN 	Dual Primary Lips	Redundant sealing for aircraft or other low leakage systems.	0.250" to 6" (6 to 150 mm)	Min 0.250" (50 mm) Max 2" (6 mm)	0.500" (13 mm)	250 psi (17 bar)	5000 sfpm (25 m/s)	3
CDE 	Dual Primary Lips w/ Excluder Lip	Redundant sealing for aircraft or other low leakage systems. Keeps water & dirt out.	0.250" to 6" (6 to 150 mm)	Min 0.250" (50 mm) Max 2" (6 mm)	0.500" (13 mm)	250 psi (17 bar)	5000 sfpm (25 m/s)	4

*Minimum width requirements can be reduced significantly if pressures are low and diameters are small. Consult PTFE Engineering for recommendations.

03/28/06

Table 10-5. Product Profiles (Continued)

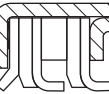
Profile	Features	Recommended Applications	Shaft Diameter Limits	Cross-Section Limits	Width Limits*	Pressure Limit at Room Temp.	Surface Speed Max.	Friction Rating
CGN 	Primary Lip Energized with Garter Spring	Use when shaft runout is 0.010" to 0.020" or abrasive media.	0.250" to 6" (6 to 150 mm)	Min 0.250" (50 mm) Max 2" (6 mm)	0.200" (5 mm)	125 psi (9 bar)	2000 sfpm (10 m/s)	3
CGE 	Primary Lip Energized with Garter Spring w/ Excluder Lip	Use when shaft runout is 0.010" to 0.020" or abrasive media. Keeps water & dirt out.	0.250" to 6" (6 to 150 mm)	Min 0.250" (50 mm) Max 2" (6 mm)	0.200" (5 mm)	125 psi (9 bar)	2000 sfpm (10 m/s)	4
CJN 	Dual Lip Seal w/ Primary Lip Energized with Garter Spring	Use when redundant sealing is needed & shaft runout is 0.010" to 0.020" or abrasive media.	0.250" to 6" (6 to 150 mm)	Min 0.250" (50 mm) Max 2" (6 mm)	0.500" (13 mm)	125 psi (9 bar)	2000 sfpm (10 m/s)	4
CJE 	Dual Lip Seal w/ Primary Lip Energized with Garter Spring w/ Excluder Lip	Use when redundant sealing is needed & shaft runout is 0.010" to 0.020" or abrasive media. Keeps water & dirt out.	0.250" to 6" (6 to 150 mm)	Min 0.250" (50 mm) Max 2" (6 mm)	0.500" (13 mm)	125 psi (17 bar)	2000 sfpm (10 m/s)	5
CHN 	High Pressure Dual-Lip Seal with Metal Backup Washer	Redundant seal for high pressure aircraft or other low leakage systems.	0.250" to 6" (6 to 150 mm)	Min 0.250" (50 mm) Max 2" (6 mm)	0.500" (13 mm)	500 psi (34 bar)	2000 sfpm (10 m/s)	4
CHE 	High Pressure Dual-Lip Seal with Metal Backup Washer w/ Excluder Lip	Redundant seal for high pressure aircraft or other low leakage systems. Keeps water & dirt out.	0.250" to 6" (6 to 150 mm)	Min 0.250" (50 mm) Max 2" (6 mm)	0.500" (13 mm)	500 psi (34 bar)	2000 sfpm (10 m/s)	5

* Minimum width requirements can be reduced significantly if pressures are low and diameters are small. Consult PTFE Engineering for recommendations.

FlexiSeal® Rotary Introduction

Catalog EPS 5350/USA

Contents

Engineering	11-2
Materials	11-4
Product Offering	11-5
FlexiSeal Rotary	
FC and FH Profiles	11-9
FF Profiles — Flanged	11-11



Rotary FlexiSeal is the answer for many radial applications.



Rotary FlexiSeal

The Rotary FlexiSeal should be used when speeds are relatively low (<1000 sfp [5 m/s]) and pressures are high (up to 10,000 psi [690 bar]). FlexiLip™ and FlexiCase™ profiles should be used when pressures are low and speeds high. Rotary FlexiSeals feature either a flanged design or an O-ring on the OD to keep the seal fixed in the bore as the shaft rotates. The O-ring can either be centered along the OD or be located in the heel of the seal. Virtually any O-ring material can be supplied with a custom rotary FlexiSeal, but a fluorocarbon material is standard.

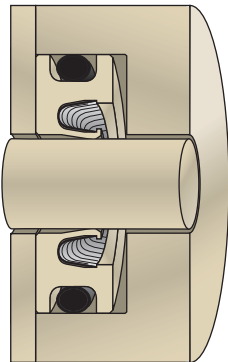

Rotary Application

Applications

Radial applications with extreme conditions that involve lower speeds and higher pressures, for which the Rotary FlexiSeal is best suited, include:

- Compressors
- Cryogenics
- FDA Clean Grade
- Jet Engines
- Hydraulic Cylinders
- Pressure Washers
- Robotics
- Rotary Unions
- Steering Cylinders
- Swivels
- Vapor Recovery Systems
- Many more

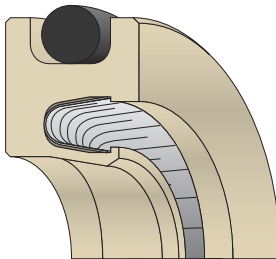

**Chamfered ID, O-Ring OD
Rotary FlexiSeal**

Markets

Since the FlexiSeal solves problems along several parameters, it can be found in virtually every market including:

- Aerospace
- Automotive
- Chemical Process
- Appliances
- Electronic
- Food & Beverage
- Heavy Machinery
- Hydraulic
- Machine Tools
- Marine
- Medical
- Military
- Oil & Gas
- Pharmaceutical
- Semiconductor

03/28/06

Choosing the Right Design

While choosing the right Rotary FlexiSeal for your application, you need to consider:

- Pressure
- Shaft Velocity
- Lubrication
- Shaft Misalignment
- Shaft Runout
- Shaft Hardness
- Shaft Surface Finish
- Different Spring Choices
- Lip Shapes
- Shaft Lead

Pressure and Shaft Velocity

Unlike reciprocating applications, seals ride on a rotating shaft in only one small area where dynamic forces and energy are concentrated. For a guide to aid in the choice of seal profile and material for optimum seal life, see **Page 2-24**.

Lubrication

While FlexiSeals made of PTFE have a natural lubricity and can be used in unlubricated applications, a film of lubricant between the seal lip and the shaft reduces seal wear and frictional heat generation, makes higher surface speeds possible, and helps prevent the seal from wearing a groove in the shaft.

Shaft Misalignment and Runout

Applications with rotating shafts may develop problems associated with shaft misalignment. Because rotary FlexiSeals are spring-loaded, they normally handle runout and eccentricity better than FlexiLip and FlexiCase seals. For more information about problems with eccentricity and runout, see **Page 2-25**.

Shaft Hardness and Surface Finish

It is critical to match the right surface roughness with the media being sealed, especially when the surface is hardened and the original finish will take some time to break in. See **Table 11-1** for recommendations and **Page 2-21** for a more general discussion on the topic.

Table 11-1. Surface Roughness, R_a

Media Being Sealed	Dynamic Surfaces		Static Surfaces	
	μ inch	μ m	μ inch	μ m
Cryogenics	4 max.	0.1 max.	8 max.	0.2 max.
Helium Gas Hydrogen Gas Freon	6 max.	0.15 max.	12 max.	0.3 max.
Air Nitrogen Gas Argon Natural Gas Fuel (Aircraft and Automotive)	8 max.	0.2 max.	16 max.	0.4 max.
Water Hydraulic Oil Crude Oil Sealants	12 max.	0.3 max.	32 max.	0.8 max.

Spring Choices

Rotary FlexiSeals are available with two different spring designs to energize the jacket: V-shaped cantilever springs (V Series) and canted-coil springs (C Series). The FFN-H flanged design included in this section uses the helical spring (H Series) and should only be used for static or very slow rotary. Details on spring features can be found on **Page 2-16**.

Table 11-2. Recommended Applications for FlexiSeal Rotary Springs

V Series	C Series	H Series
rotary shafts <1000 sfpm (5 m/s)	rotary shafts <1000 sfpm (5 m/s)	flanged rotary seals
wide tolerance and misaligned glands	wide tolerance and misaligned glands	static or very slow dynamic seals (<50 sfpm [0.25 m/s])
abrasive media (when scraper lip is designated)	friction critical and very small diameter applications	when sealability is critical
dynamic applications to 450 °F (230 °C)	dynamic applications to 450 °F (230 °C)	applications below -100 °F (-75 °C)

Lip Shapes

Rotary FlexiSeal profiles can be optimized by changing their lip shapes. Chamfered lips maximize sealability while minimizing friction. Scraper lips prevent particles from accumulating at the lip, which makes wash-downs more effective.

Shaft Machine Lead

To avoid pumping fluid under the seal lip, the lead from machining needs to be kept to less than 0.05 degrees. More on machine lead on **Page 2-7**.

FlexiSeal® Rotary Materials

Catalog EPS 5350/USA

Common Materials Used in this Product

The most popular PTFE fillers used for FlexiSeal Rotary products are carbon fiber, graphite, Ryton®/carbon and Ryton/carbon/TFM. PTFE is also popular for these products without any filler (virgin PTFE).



A number of other fillers are used in combination with PTFE, and non-PTFE compounds are available. More information on these materials and their properties is available on **Pages 9-7 and 9-8**. For best results consult the EPS Division PTFE Application Engineering team at (801) 972-3000.

* Ryton is a registered trademark of Chevron Phillips Chemical Company.

0502 — Carbon Fiber Filled

Carbon fiber lowers creep, increases flex and compressive modulus and raises hardness. Coefficient of thermal expansion is lowered and thermal conductivity is higher for compounds of carbon fiber filled PTFE. Ideal for automotive applications in shock absorbers and water pumps.

0602 — Ryton/Carbon Filled

Ryton/Carbon filled PTFE features improved surface lubricity and abrasion resistance. It should be used only on shafts hardened to 60 Rc or more.

0301 — Graphite Filled

Graphite filled PTFE has extremely low coefficient of friction due to the low friction characteristics of graphite. Graphite is chemically inert. Graphite imparts excellent wear properties and high PV to PTFE.

0601 — Aromatic Polyester Filled

Aromatic Polyester offers excellent high temperature capabilities and excellent wear resistance against soft, dynamic surfaces. Aromatic polyester is not recommended for sealing applications involving steam.

0203 — Fiberglass Filled

Glass fiber is the most common filler with a positive impact on creep performance of PTFE. Glass fiber adds wear resistance and offers good compression strength.

FlexiSeal® Rotary Product Offering

Catalog EPS 5350/USA

Decision Tree

Medium to High Speed Rotary FlexiSeal

The decision trees in this guide are to be used as an engineering guide only. Often several other parameters must be considered to optimize seal design. Contact Parker's PTFE Engineering Team for confirmation of your choice or further recommendations. Parker also recommends that any seal be tested in the application conditions before releasing for production.

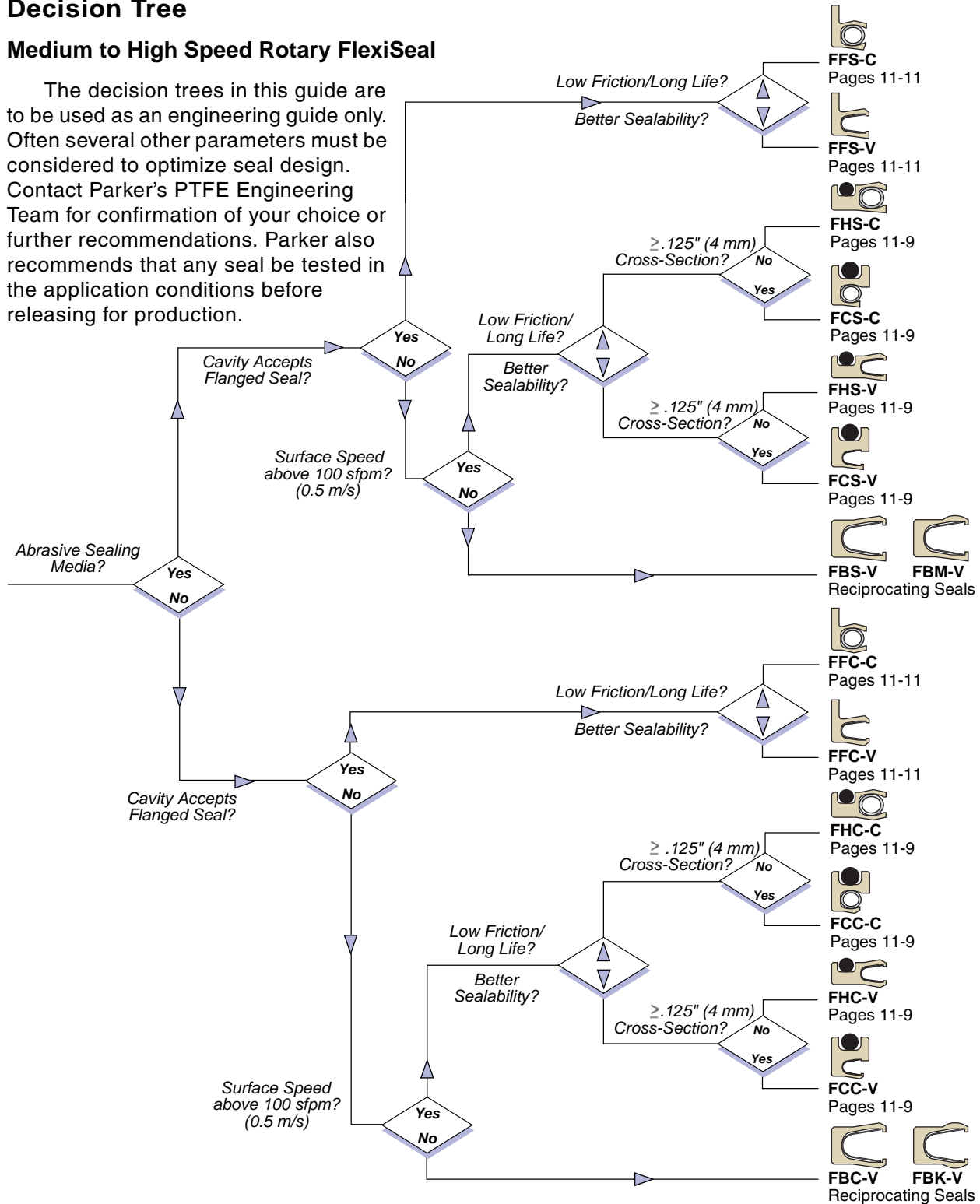

03/28/06

Part Number Nomenclature — FlexiSeal Rotary

Table 11-3. FlexiSeal Rotary Part Number Nomenclature

English

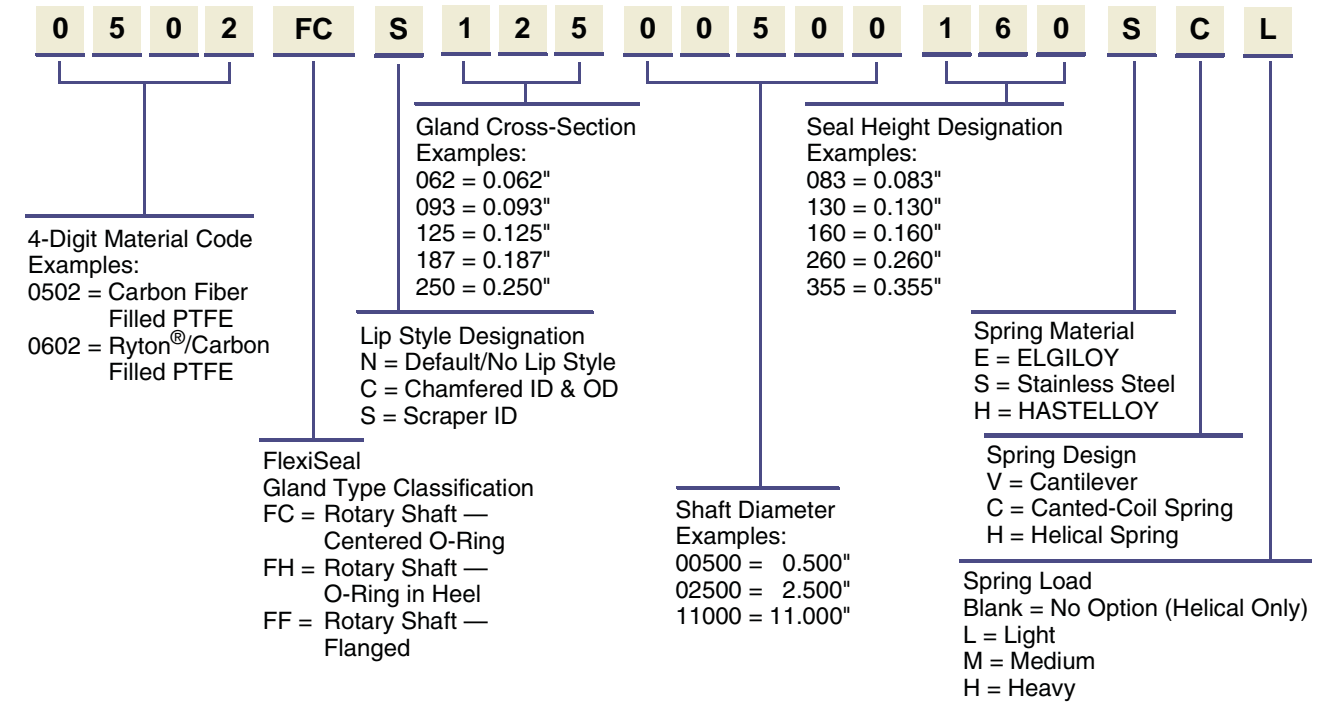

Metric

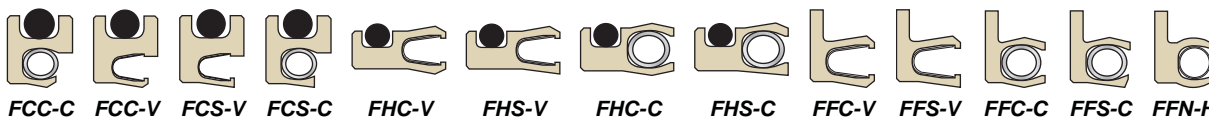
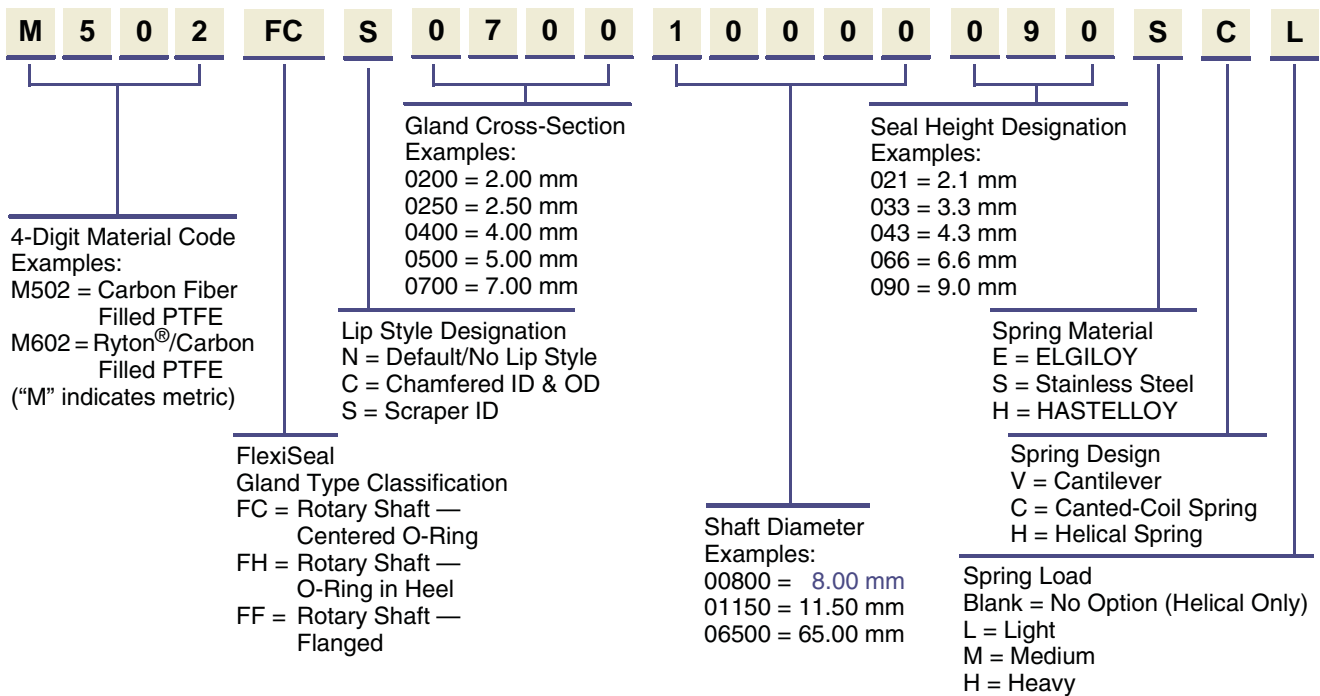

03/28/06

Profiles

Table 11-4. Product Profiles





Profile	Features	Recommended Applications	Available as Standard in High Pressure Extended Heel	Friction Rating	Low Pressure Sealability	Good in Abrasive Media	Max. Rotary Surface Speed	Gland Dimension Table Location
FCC-V 	O-Ring Centered in OD, Chamfered ID, Cantilever Spring	Optimum sealability. Available in .125" (4 mm) cross-section and higher.	Yes	Medium	Very Good	No	1000 sfpm (5 m/s)	Pages B-93, C-22
FCS-V 	O-Ring Centered in OD, Scraper ID, Cantilever Spring	Minimizes contamination threat. Available in .125" (4 mm) cross-section and higher.	Yes	Medium	Very Good	Yes	1000 sfpm (5 m/s)	Pages B-93, C-22
FCC-C 	O-Ring Centered in OD, Chamfered ID, Canted-Coil Spring	Reduced friction and sealability. Available in .125" (4 mm) cross-section and higher	Yes	Very Low	Good	No	1000 sfpm (5 m/s)	Pages B-93, C-22
FCS-C 	O-Ring Centered in OD, Scraper ID, Canted-Coil Spring	Low friction with contamination resistance. Available in .125" (4 mm) cross-section and higher	Yes	Low	Good	Yes	1000 sfpm (5 m/s)	Pages B-93, C-22
FHC-V 	O-Ring in Heel OD, Chamfered ID, Cantilever Spring	Optimum sealability. Available in extended heel option only.	Yes	Medium	Very Good	No	1000 sfpm (5 m/s)	Pages B-93, C-22
FHS-V 	O-Ring in Heel OD, Scraper ID, Cantilever Spring	Minimizes contamination threat. Available in extended heel option only.	Yes	Medium	Very Good	Yes	1000 sfpm (5 m/s)	Pages B-93, C-22

Table 11-4. Product Profiles (Continued)

Profile	Features	Recommended Applications	Available as Standard in High Pressure Extended Heel	Friction Rating	Low Pressure Sealability	Good in Abrasive Media	Max. Rotary Surface Speed	Gland Dimension Table Location
FHC-C 	O-Ring in Heel OD, Chamfered ID, Canted-Coil Spring	Reduced friction and sealability. Available in extended heel option only.	Yes	Very Low	Good	No	1000 sfpm (5 m/s)	Pages B-93, C-22
FHS-C 	O-Ring in Heel OD, Scraper ID, Canted-Coil Spring	Low friction with contamination resistance. Available in extended heel option only.	Yes	Low	Good	Yes	1000 sfpm (5 m/s)	Pages B-93, C-22
FFC-V 	Flanged Heel OD, Chamfered ID, Cantilever Spring	Optimum sealability. Premium bore retention.	No	Medium	Very Good	No	1500 sfpm (7.5 m/s)	Pages B-97, C-22
FFS-V 	Flanged Heel OD, Scraper ID, Cantilever Spring	Minimizes contamination threat. Premium bore retention.	No	Medium	Very Good	Yes	1500 sfpm (7.5 m/s)	Pages B-97, C-22
FFC-C 	Flanged Heel OD, Chamfered ID, Canted-Coil Spring	Reduced friction and sealability. Premium bore retention.	No	Very Low	Good	No	1500 sfpm (7.5 m/s)	Pages B-97, C-22
FFS-C 	Flanged Heel OD, Scraper ID, Canted-Coil Spring	Low friction with contamination resistance. Premium bore retention.	No	Low	Good	Yes	1500 sfpm (7.5 m/s)	Pages B-97, C-22
FFN-H 	Flanged Heel OD, Rounded ID, Helical Spring	Static or intermittent rotary only. High sealability and friction.	No	High	Excellent	No	50 sfpm (0.25 m/s)	Pages B-97, C-22

FlexiSeal® Rotary FC and FH Profiles

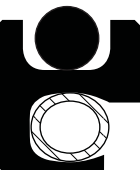
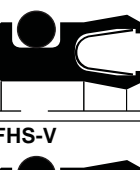
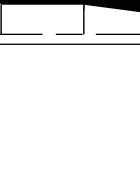
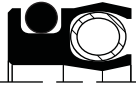
Catalog EPS 5350/USA

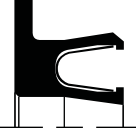
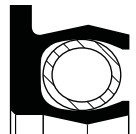
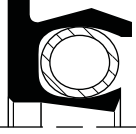
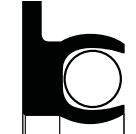
Inch FC part numbers are available only in 125 (1/8") cross-section and higher.

Metric FC part numbers are available only in 0400 (4 mm) cross-section and higher.

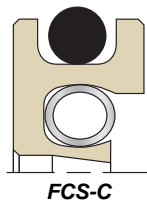
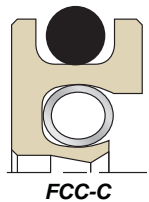
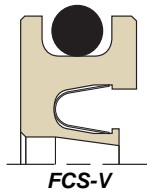
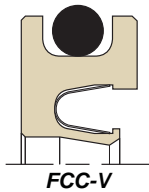

FH part numbers are available in extended heel option only.

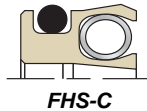
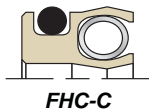
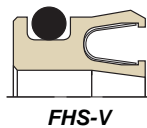
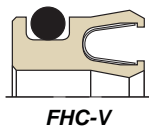

FC and FH Profiles

FC FlexiSeal Rotary Shaft, Centered O-Ring profiles and FH FlexiSeal Rotary Shaft, O-Ring in Heel profiles are available in the Industrial Inch/Fractional on **Page B-93** and Metric sizes on **Page C-22**.

Design Considerations

- Hardware Configurations/Installation, see **Page 2-21**
- Surface Finish and Hardness, see **Page 2-21**
- Spring Choices, see **Page 2-16**
- Lip Shapes, see **Page 2-20**
- Rotary Seal Considerations, see **Page 2-26**
- Shaft Misalignment Issues, see **Page 2-25**

Part Number Example

Table 11-5. FC and FH Inch/Fractional Part Number

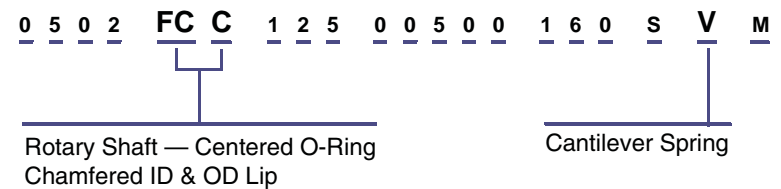
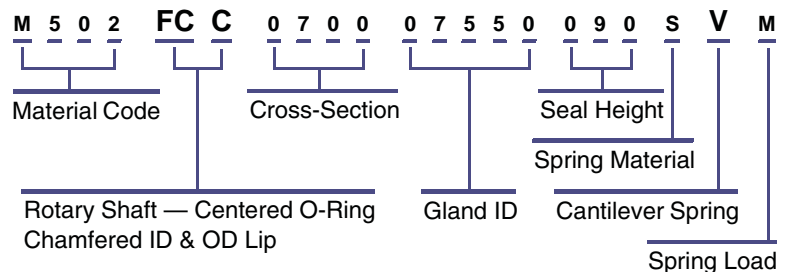
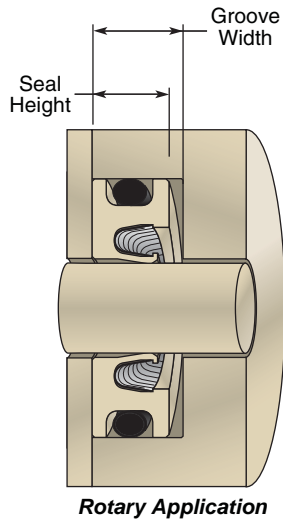

Table 11-6. FC and FH Metric Part Number



Important: For full listings of standard sizes, see **Pages B-93** and **C-22**.



Extended Heel Option

All part numbers call for the standard seal height for pressures below 3000 psi (207 bar).

The heel of a FlexiSeal can be extended to increase extrusion resistance simply by changing the seal height callout in the part number.

Just find where the seal height dimension for the groove width is designated in the gland tables and switch to the longer extended heel callout in the part number.

Example: Inch

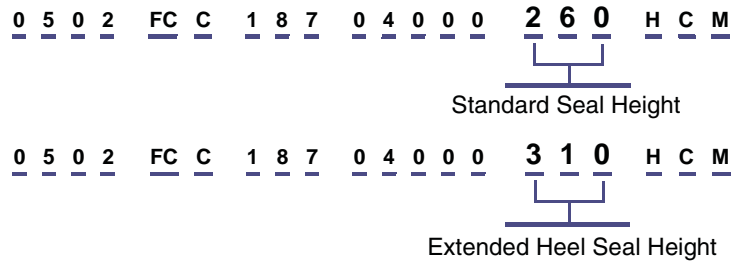

Table 11-7. Inch/Fractional Seal Height Callouts

Radial Cross-Section	Standard Heel Callout	Extended Heel Callout
062	N/A	140
093	N/A	165
125	160	220
187	260	310
250	355	450

Example: Metric

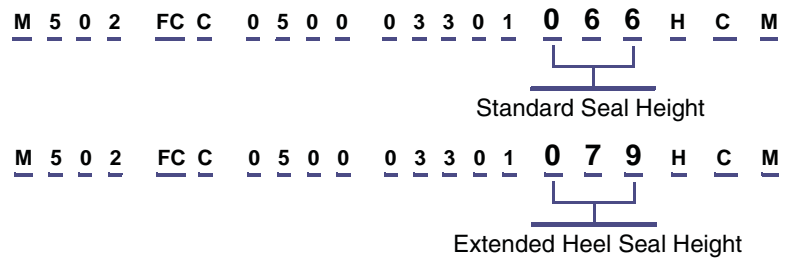

Table 11-8. Metric Seal Height Callouts

Radial Cross-Section	Standard Heel Callout	Extended Heel Callout
0200	N/A	036
0250	N/A	042
0400	043	056
0500	066	079
0700	090	114

Note: FH profiles are available in extended heel option only.

Important: For full listings of standard sizes, see **Pages B-93** and **C-22**.

FlexiSeal® Rotary FF Profiles — Flanged

Catalog EPS 5350/USA



Flanged FlexiSeals

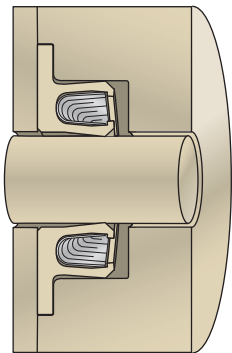

Flanged Rotary Application

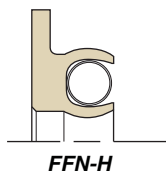
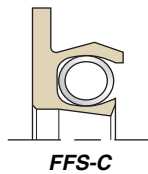
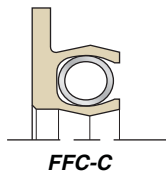
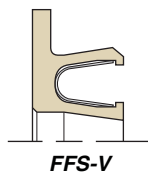
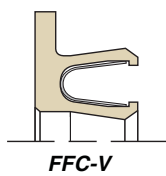

FF Profiles

FF FlexiSeal Rotary Shaft, Flanged profiles are clamped axially in the gland to ensure that the seal does not spin with the shaft, especially in applications with frequent thermal cycling.

Design Considerations

- Hardware Configurations/Installation, see **Page 2-21**
- Surface Finish and Hardness, see **Page 2-21**
- Spring Choices, see **Page 2-16**
- Lip Shapes, see **Page 2-20**
- Rotary Seal Considerations, see **Page 2-26**
- Shaft Misalignment Issues, see **Page 2-25**

Part Number Example

Table 11-9. FF Flanged Inch/Fractional Part Number

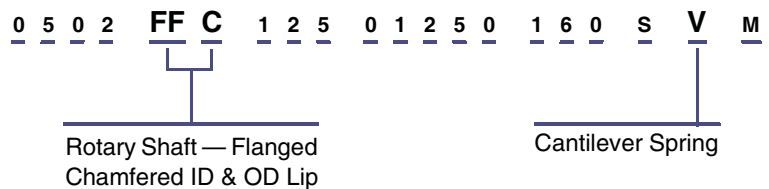
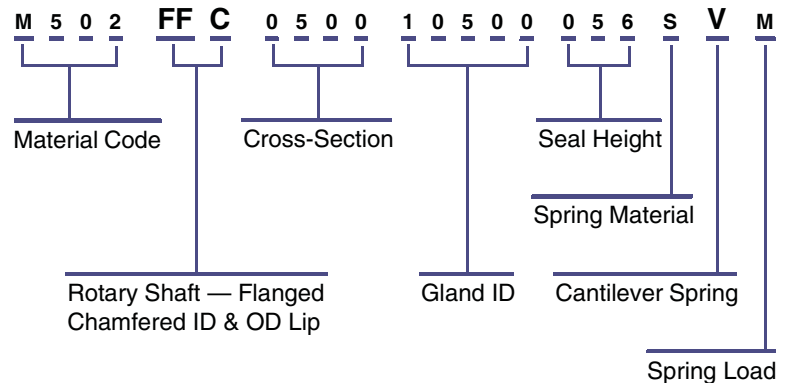

Table 11-10. FF Flanged Metric Part Number



Important: For full listings of standard sizes, see **Pages B-97** and **C-22**.

V-Seals and Excluders

Introduction

Catalog EPS 5350/USA

Contents

Engineering.	12-2
Materials	12-3
Product Offering	12-4
V-Seals	
A Profile	12-5
S Profile	12-6
L Profile	12-7
E Profile	12-8
DS and SSW Profiles	12-9

V-Seals can be installed over flanges, pulleys and housings without dismantling.

The Parker V-Seal is an all rubber rotary shaft seal that is used primarily for the exclusion of dirt, dust or water as well as retention of grease and other viscous fluids. The V-Seal can also be used as a secondary seal to protect primary seals from hostile environments. Centrifugal force produces a decrease in contact pressure of the lip as speed increases, keeping frictional losses and heat to a minimum.

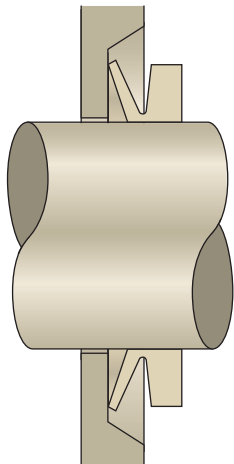

V-Seal Application

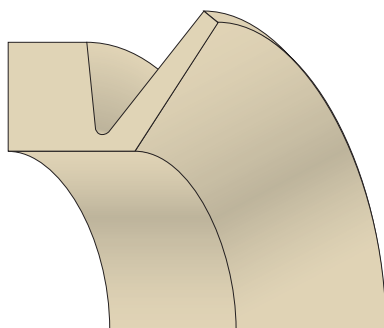

V-Seal

Applications

V-Seals can be found in a variety of applications including:

- Appliances
- Automotive
- Agriculture
- Electric Motors
- Rolling Mills
- Mining Equipment
- Gear boxes
- Pumps
- Conveyors
- Backup rolls, Work Rolls
- Pillow Blocks
- Spindles

Sealing System

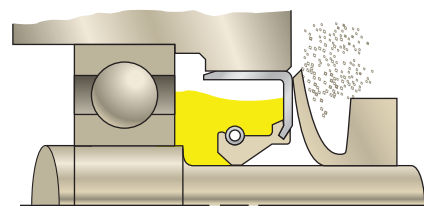

V-Seal with Primary Seal

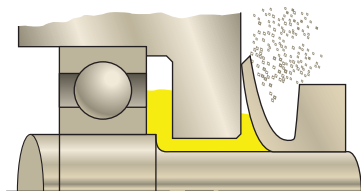

**V-Seal Alone
(Grease Only Application)**

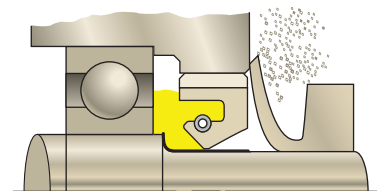

**V-Seal with Primary Seal and
Quick Sleeve**

03/28/06



V-Seals and Excluders Engineering

Catalog EPS 5350/USA

Design Engineering

The flexible construction of the lip and hinge of the V-Seal allows it to tolerate a certain amount of runout, shaft to bore misalignment and eccentricity. Centrifugal force produces a decrease in contact pressure of the lip as speed increases, keeping frictional losses and heat to a minimum. The result is excellent wear characteristics and extended seal life. A V-Seal will not “groove” the shaft.

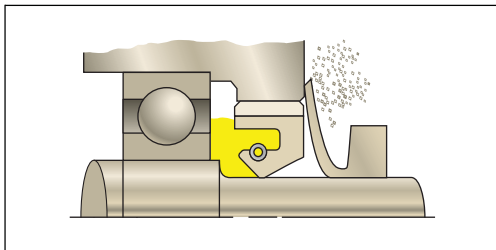

Figure 12-1. V-Seal against bearing housing.

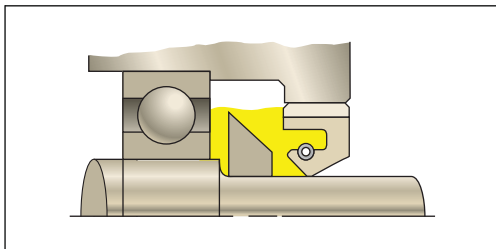

Figure 12-2. Standard lip seal with internal DS sling to protect lip from lubricant surge.

Design Features

Clipper V-Seals are stretched over the shaft and mounted against a counterface. V-Seals can be installed over flanges, pulleys and housings without dismantling (see **Figure 12-1**).

The DS design is press fit onto the shaft and is used alone or in conjunction with a conventional radial lip seal to enhance seal performance. The DS design is used to deflect internal heavy oil surge (see **Figure 12-2**) and can be used externally to deflect dust and spray.

The DS features the traditional Clipper nonmetallic composite construction for stability and performance.

The SSW excluder is similar to V-Seals, except the seal is press fit on the shaft for heavy duty applications. The SSW excluder rotates with the shaft and seals against the counterface (see **Figure 12-3**). This face-sealing action makes the SSW an essential part of any conventional radial seal application where severe abrasive particles, dust or external spray are present. SSW excluders are used to protect the primary seal.

The SSW features the traditional nonmetallic composite construction for stability and performance.

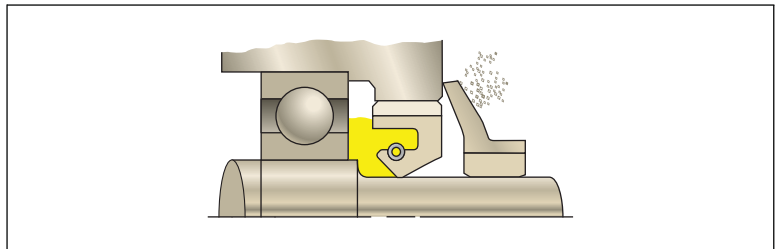

Figure 12-3. SSW excluder to protect seal from contaminants.

V-Seals and Excluders Materials

Catalog EPS 5350/USA

Common Materials Used in this Product

Clipper V-Seals and excluders are available in a variety of rubber compounds.

NBR — Nitrile

Standard Nitrile is the most commonly used polymer in the rotary shaft seal industry. NBR has very good resistance to oil, fuel and alkali solutions. Nitrile offers excellent resistance to petroleum-based hydraulic fluids and is resistant to hydrocarbon solvents. Standard Nitrile has poor resistance to ozone, ketones, automotive or aircraft brake fluid, and steam or hot water. Standard Nitrile is recommended for operating in temperatures ranging from -20 to +250 °F (-29 to +121 °C) and offers good mechanical properties and abrasion resistance.

FKM — Fluoroelastomer

FKM provides excellent resistance to oils, fuels and hydraulic fluids at temperatures that far exceed standard Nitrile. It also has very good resistance to flame and excellent impermeability to gases and vapors. FKM is recommended for operating temperatures that range from -40 to +400 °F (-40 to +204 °C).

Additional Materials Available

The Parker V-Seal is also available in other materials to meet a variety of applications, including neoprene, silicone and polyacrylate.

03/28/06



V-Seals and Excluders

Product Offering

Catalog EPS 5350/USA

Product Line







The V-Seals are flexible rubber seals which mount on and rotate with the shaft against a counterface. The flexibility of the seal allows for some shaft end play. The seal configuration protects against contamination and can be used to supplement the primary shaft seal in a harsh environment.

The DS can be used as a deflector or an excluder and is manufactured from a dense composite material.

The SSW design is similar to the V-Seal, but is manufactured with a non-metallic composite construction at the ID that is press fit onto the shaft for heavy duty applications. The SSW will not lose the press fit on the shaft at higher shaft speeds — allowing for more consistent lip contact.

Profiles

Table 12-1. Product Profiles

Series	Features	Applications	Page
Style A 	Most common style. Cross-section varies with shaft diameter. For shaft diameters ranging from 0.11 to 79" (3 to 2006 mm).	Appliances, automotive, agriculture, electric motors, rolling mills, pumps gear boxes, spindles, pillow blocks, conveyors, mining equipment, work rolls	12-5
Style S 	Wide and tapered cross-section provides firm hold on shaft for higher speeds. Shaft diameters ranging from 0.18 to 8" (4.5 to 203 mm).	Appliances, automotive, agriculture, electric motors, rolling mills, pumps gear boxes, spindles, pillow blocks, conveyors, mining equipment, work rolls	12-6
Style L 	Narrow cross-section profile throughout the size range. Often used in combination with LER rings. 5.32" to 18.7" (135 to 475 mm).	Pillow block bearings, appliances, automotive, electric motors.	12-7
Style E 	Larger cross-section. Accommodates ± 0.5" axial movement. Shaft diameters ranging from 17 to 79" (457 to 2006 mm).	Rolling mills, work rolls, backup rolls	12-8
Style DS 	DS is designed for internal deflection of heavy oil surges or external deflection of dust or spray. The design is press fit onto the shaft. DS is known as a deflector seal.	Used internally on gearboxes or other industrial equipment with internal splash. Also used as external slinger.	12-9
Style SSW 	SSW is designed for applications for external washdowns or severe dusty environments. The seal rides against the face of the housing to keep contamination from the primary seals.	Electric motors, mining or washdown applications, rolling mills.	12-9

V-Seals and Excluders

A Profile

Catalog EPS 5350/USA

V-Seal A

Most common style. Cross-section varies with shaft diameter.

Technical Data

Operating Temperature Range

NBR: -40 to +225 °F (-40 to 107 °C)

FKM: -30 to +325 °F (-34 to 163 °C)

Shaft Surface Speed

Up to 1600 fpm (8.1 m/s)

Maximum Pressure

N/A

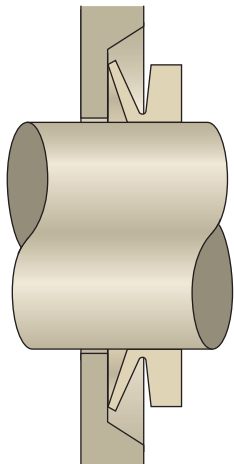
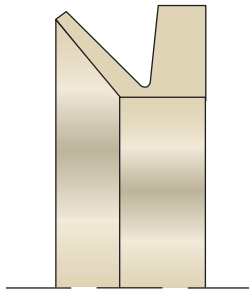

V-Seal A in Assembly

Choosing a Seal

Select the larger V-Seal when the shaft diameter is on the boundary between two sizes.

Part Number Nomenclature — A Profile

Table 12-2. V-Seal A Part Number Nomenclature

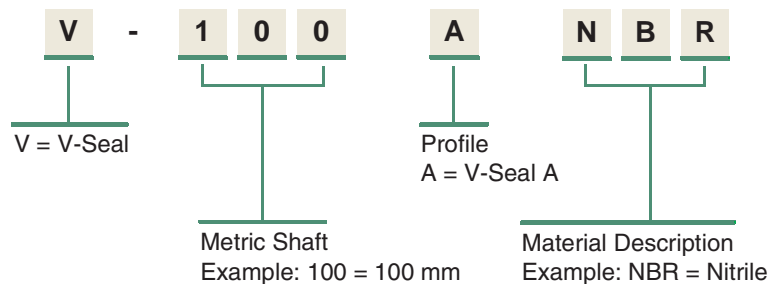

Important: For full listings of standard sizes, see **Appendix E**.

03/28/06

V-Seals and Excluders

S Profile

Catalog EPS 5350/USA

V-Seal S

Wide and tapered cross-section provides firm hold on shaft for higher speed.

Technical Data

Operating Temperature Range

NBR: -40 to +225 °F (-40 to 107 °C)

FKM: -30 to +325 °F (-34 to 163 °C)

Shaft Surface Speed

Up to 1600 fpm (8.1 m/s)

Maximum Pressure

N/A

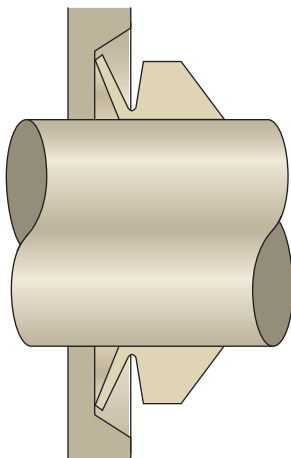
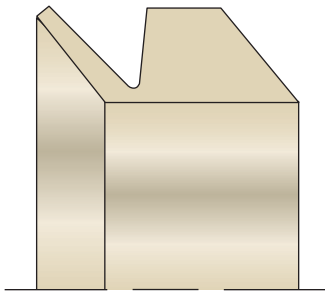

V-Seal S in Assembly

Choosing a Seal

Select the larger V-Seal when the shaft diameter is on the boundary between two sizes.

Part Number Nomenclature — S Profile

Table 12-3. V-Seal S Part Number Nomenclature

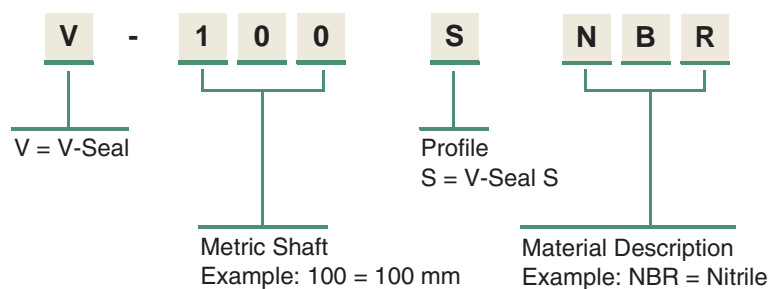

Important: For full listings of standard sizes, see **Appendix E**.

V-Seals and Excluders

L Profile

Catalog EPS 5350/USA

V-Seal L

Narrow cross-section profile throughout the size range. Often used in combination with LER rings.

Technical Data

Operating Temperature Range

NBR: -40 to +225 °F (-40 to 107 °C)

FKM: -30 to +325 °F (-34 to 163 °C)

Shaft Surface Speed

Up to 1600 fpm (8.1 m/s)

Maximum Pressure

N/A

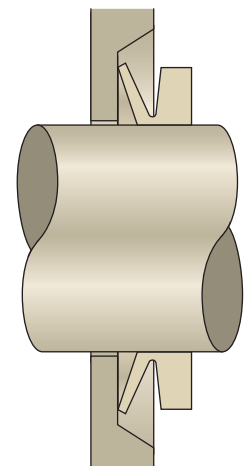
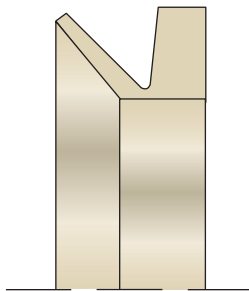

V-Seal L in Assembly

Choosing a Seal

Select the larger V-Seal when the shaft diameter is on the boundary between two sizes.

Part Number Nomenclature — L Profile

Table 12-4. V-Seal L Part Number Nomenclature

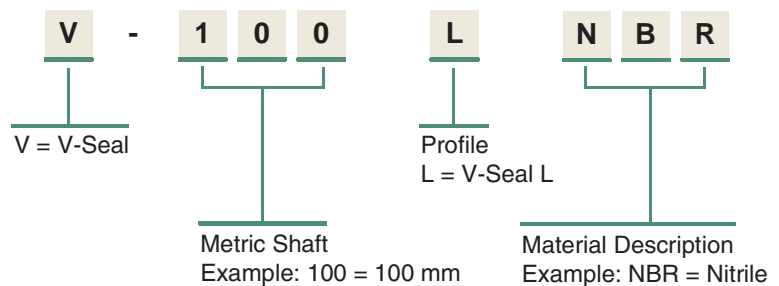

Important: For full listings of standard sizes, see **Appendix E**.

03/28/06

V-Seals and Excluders

E Profile

Catalog EPS 5350/USA

V-Seal E

Larger cross-section. Accommodates $\pm 0.5"$ axial movement.

Technical Data

Operating Temperature Range

NBR: -40 to +225 °F (-40 to 107 °C)

FKM: -30 to +325 °F (-34 to 163 °C)

Shaft Surface Speed

Up to 1600 fpm (8.1 m/s)

Maximum Pressure

N/A

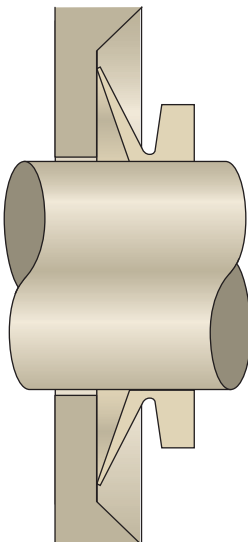
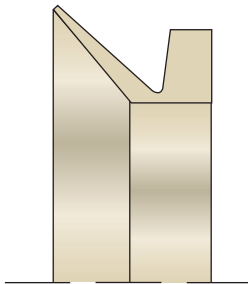

V-Seal E in Assembly

Choosing a Seal

Select the larger V-Seal when the shaft diameter is on the boundary between two sizes.

Part Number Nomenclature — E Profile

Table 12-5. V-Seal E Part Number Nomenclature

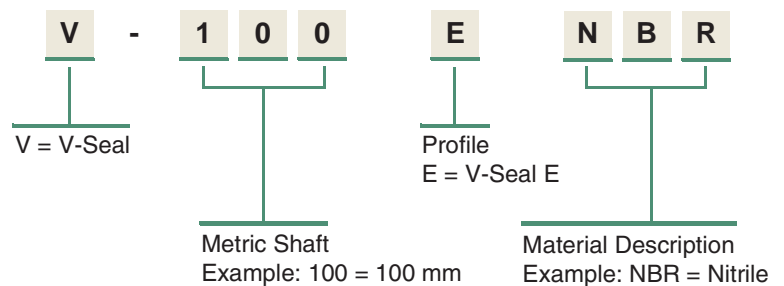

Important: For full listings of standard sizes, see **Appendix E**.

V-Seals and Excluders

DS and SSW Profiles

Catalog EPS 5350/USA

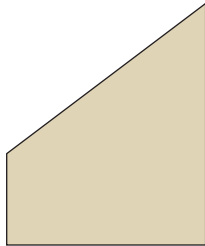

DS Excluder

DS Excluder

Designed for internal deflection of heavy oil surges or external exclusion of dust or spray.

The DS features the traditional Clipper nonmetallic composite construction for enhanced stability and optimal performance.

Technical Data

Operating Temperature Range

NBR: -20 to +250 °F (-29 to 121 °C)

FKM: -40 to +400 °F (-40 to 204 °C)

Shaft Surface Speed

Up to 2500 fpm (12.7 m/s)

Maximum Pressure

N/A

Important: See **Appendix B** for size listing.

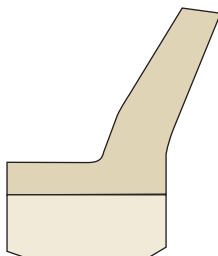

SSW Excluder

SSW Excluder

Similar to V-seals except they are press fit on shaft for heavy duty applications. Designed for applications for external washdowns or severe dusty environments. The seal rides against the face of the housing to keep contamination from the primary seal. The SSW design features the traditional Clipper nonmetallic composite construction for stability and optimal performance.

Technical Data

Operating Temperature Range

NBR: -20 to +250 °F (-29 to 121 °C)

FKM: -40 to +400 °F (-40C to 204 °C)

Shaft Surface Speed

Thru 2500 fpm (12.7 m/s)

Maximum Pressure

N/A

Important: See **Appendix B** for size listing.

03/28/06

Rotary Seal Design Guide Appendix

[Design Action Request Form](#)

A

[Rotary Lip Seal Inch Sizes](#)

B

[Rotary Lip Seal Metric Sizes](#)

C

[Solid to Split Seal Calculator](#)

D

[Sleeve & V-Seal Sizes](#)

E

[ProTech™ Sizes Inch & Metric](#)

F

[Conversions — Size/Speed/Temp.](#)

G

[Chemical Compatibility](#)

H

[Interchange](#)

I

[Other Parker EPS Products](#)

J



Parker Hannifin Corporation
EPS Division
Toll Free: (800) 233-3900

www.parkerseals.com

Design Action Request Form

Catalog EPS 5350/USA

NEED HELP? If you need assistance, please photocopy these three pages. Fill out the required information and fax to (936) 560-8998. Use the information below and other information in this catalog to determine the dimensions needed. We will contact you to discuss your specific application and make recommendations. If you need help filling out this form, please call Applications Engineering at (800) 233-3900.

ENGINEERED POLYMER SYSTEMS DIVISION DESIGN ACTION REQUEST

Applications Engineering Use:

Project # _____
 Date Entered _____
 Date Required _____
 Prepared by _____
 Territory Mgr. _____
 Distributor _____
 Dist. Sales _____

Referred by _____
 Lead # _____

COMPANY: _____ FAX NUMBER: _____
 ADDRESS: _____ P.O. BOX: _____ MAIL STOP: _____
 CITY: _____ STATE: _____ ZIP: _____ COUNTRY: _____
 CONTACT: _____ TITLE: _____ PHONE: _____ EXT: _____
 ALT. CONTACT: _____ TITLE: _____ PHONE: _____ EXT: _____
 E-MAIL: _____

EQUIPMENT/MANUFACTURER: _____ MODEL NO.: _____
 EXISTING SEAL MANUFACTURER: _____ PART NO.: _____
REASON FOR CHANGE: PERFORMANCE DELIVERY NEW APPLICATION PRICE
 CURRENT PRICE: _____ @ _____ PCS. MONTHLY USAGE: _____ HOURS OPERATION: _____ HOURS SERV. LIFE: _____
 TARGET PRICE: _____ @ _____ PCS. QUOTE QTY.: _____ PROTO QTY.: _____ DATE PROTO REQ'D.: _____
 SPECIAL INSPECTION REQUIREMENTS: YES NO SPECIAL PACKAGING REQUIREMENTS: YES NO
 EXPLAIN: _____

MOTION

STATIC RECIPROCATING OSCILLATORY ROTARY

PRODUCT TYPE

NON-ROTARY — FILL OUT SECOND PAGE

ROD/SHAFT WIPER
 PISTON BEARING
 INTERNAL FACE VANE
 EXTERNAL FACE NON-SEAL

ROTARY — FILL OUT THIRD PAGE

SOLID SEAL PTFE LIP SEAL
 SPLIT SEAL ELASTOMER LIP SEAL
 BEARING ISOLATOR

03/28/06



Design Action Request Form

NON-ROTARY SEALS

OPERATING PARAMETERS

TEMPERATURE: °K °F °C
 PRESSURE: PSI BAR MPA
 STROKE LENGTH (RECIPROCATING): INCH MM
 CYCLE RATE: /MIN. /HR. HZ
 DEGREE OF ARC (OSCILLATING): DEGREES
 VELOCITY: FT/MIN. MM/MIN.
 VACUUM: IN HG TORR

MINIMUM	OPERATING	MAXIMUM
_____	_____	_____
_____	_____	_____
_____	_____	_____
_____	_____	_____
_____	_____	_____
_____	_____	_____

MEDIA TO BE SEALED: _____

Rod

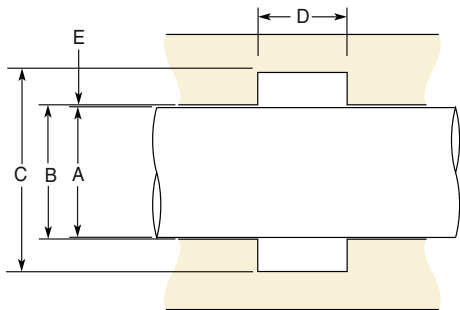

Piston

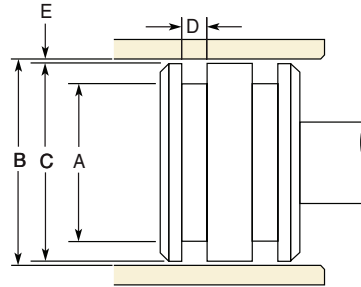

Face Seal

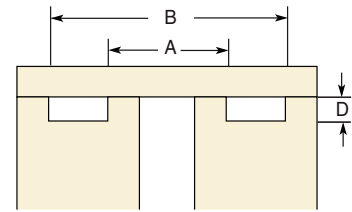

Other Piston

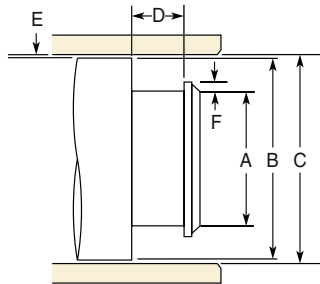

Other Rod

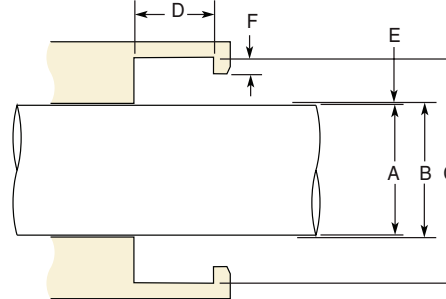

HARDWARE SPECIFICATIONS

A DIAMETER: MIN. _____ MAX. _____
 B DIAMETER: MIN. _____ MAX. _____
 C DIAMETER: MIN. _____ MAX. _____
 D GROOVE WIDTH: MIN. _____ MAX. _____
 E RADIAL CLEARANCE: MIN. _____ MAX. _____
 F ROD / PISTON STEP HEIGHT: MIN. _____ MAX. _____

HARDWARE DRAWINGS INCLUDED WITH DAR: YES NO

HARDNESS _____ FINISH _____ MAT'L _____
 HARDNESS _____ FINISH _____ MAT'L _____
 HARDNESS _____ FINISH _____ MAT'L _____
 CAN HARDWARE BE CHANGED? YES NO
 HOW? _____

SIDE LOAD (LBS. NEWTONS): _____
 MIL-G-5514 O-RING DASH #: _____ BACK-UP WIDTH _____
 AS4716 O-RING DASH #: _____ BACK-UP WIDTH _____

GLAND TYPE

____ SPLIT ____ OPEN
 ____ SOLID ____ STEPPED

METRIC

YES
 NO

PERFORMANCE REQUIREMENTS

(CIRCLE ONE)
 FRICTION: LBS OZ GMS BREAKOUT ____ DYNAMIC ____
 EXPECTED LIFE: CYC HRS YRS _____
 MAX. LEAKAGE: DROPS CC/MIN _____
 MOST CRITICAL ASPECT: _____
 CONTAMINATION: _____

03/28/06

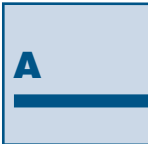

ROTARY SEALS

SHAFT MOVEMENT

- CLOCKWISE
- COUNTERCLOCKWISE
- BIDIRECTIONAL
- OSCILLATING

MEDIA TO SEAL IN: _____

MEDIA TO SEAL OUT: _____

SHAFT POSITION

- HORIZONTAL
- VERTICAL UP
- VERTICAL DOWN

LUBRICATION METHOD

- OIL SPLASH, OIL LEVEL BELOW SHAFT
- OIL FLOODED, OIL LEVEL ABOVE SHAFT
- GREASE W/O PURGE
- GREASE WITH PURGE
- OIL MIST

ALLOWABLE LEAKAGE: _____

OPERATING PARAMETERS

UNIT (CIRCLE ONE)

	°K	°F	°C	MINIMUM	OPERATING	MAXIMUM
TEMPERATURE:	<input type="checkbox"/>	<input type="checkbox"/>	<input type="checkbox"/>	_____	_____	_____
PRESSURE:	PSI	BAR	MPA	_____	_____	_____
FRICITIONAL TORQUE REQUIREMENTS:	in-lb.	Nm		_____	_____	_____

DIMENSIONS LISTED ARE:

- INCH
- METRIC

- SHAFT AXIAL: _____ ± _____
- A SHAFT: _____ ± _____
- C BORE: _____ ± _____
- D BORE: _____ ± _____
- SHAFT (RPM): _____
- SHAFT MATERIAL: _____
- BORE (RA): _____
- RUNOUT (TIR): _____
- ECCENTRICITY: _____

- SHAFT TO BORE: _____
- B SHAFT: _____
- E DISTANCE TO FIRST: _____
- F DIST. FROM HSG.: _____
- SHAFT FINISH (Ra): _____
- BORE MATERIAL: _____

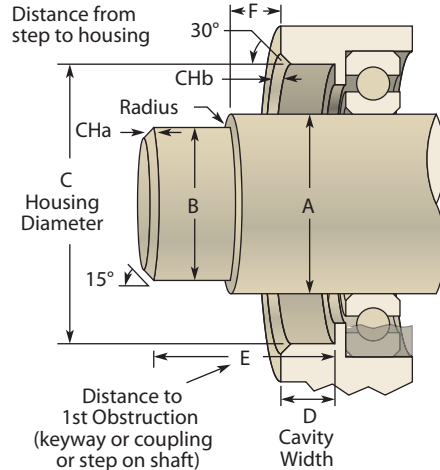

SHAFT FEATURES:

- KEYWAY
- SPLINE
- SNAP RING GROOVE
- O-RING GROOVE
- FDA MATERIAL REQUIRED
- SEAL NEEDS TO EXCLUDE HIGH PRESSURE WATER SPRAY

SEAL INSTALLATION DATA

INSTALLATION DIRECTION:

- LIP FACES TOWARDS BEARING



- LIP FACES AWAY FROM BEARING



SEAL INSTALLED BY: PUSHING SEAL OVER SHAFT PUSHING SHAFT THROUGH SEAL

IF SHAFT IS PUSHED THROUGH SEAL:

- SHAFT DIRECTION OPPOSES LIP DIRECTION



- SHAFT DIRECTION IS SAME AS LIP DIRECTION



03/28/06



Rotary Lip Seal Inch Sizes

.157 to .500

Catalog EPS 5350/USA

B

Shaft Dia.	Bore Dia.	Seal Width	Parker Part Number	Seal Type	Material
.157	.750	.250	6656 H1L5	SS	NBR
.157	.750	.250	6656 H3L8	SS	CR
.188	.438	.125	10722 H1L7	SS	NBR
.188	.438	.125	10722 H3L8	SS	CR
.188	1.438	.375	TMAL 1438-2440	TMAL	PTFE
.250	.500	.125	250-500-125EVBN	VB	NBR
.250	.500	.188	5620 H3L8	SS	CR
.250	.623	.187	TN 0623-1212	TN	N/P
.250	.623	.187	TNV 0623-1212	TN	N/P
.250	.625	.188	4839 H3L8	SS	CR
.250	.625	.250	TN 0625-1612	TN	N/P
.250	.625	.250	TN 0625-1612 304	TN	N/P
.250	.625	.250	TNV 0625-1612	TN	N/P
.250	.688	.188	16613 H3L8	SS	CR
.250	.750	.250	15596 5066	HP	FKM
.250	.750	.250	15596 5066 304	HP	FKM
.250	.750	.250	15596 5066 316	HP	FKM
.250	.750	.250	250-750-250ETBN	TB	NBR
.250	.750	.250	7037 H1L7	SS	NBR
.250	1.000	.250	8978 H1L7	SS	NBR
.310	.787	.354	16842 H1L7	P	NBR
.310	.787	.354	16842 H5L16	P	FKM
.312	.625	.157	312-625-157ETBN	TB	NBR
.312	.688	.188	6269 H3L8	SS	CR
.312	.750	.188	19441 ALLL7	MCL	NBR
.312	.750	.250	312-750-250EVBN	VB	NBR
.312	.750	.250	7016 H3L8	SS	CR
.313	.688	.109	11326 H3L8	SS	CR
.313	.688	.109	11326 H5L16	SS	FKM
.313	.999	.313	313-999-313ETCN	TC	NBR
.370	.562	.219	13125 ALLL7	P	NBR
.375	.562	.125	NVC81021	VC	NBR
.375	.625	.188	14605 H3L8	SS	CR
.375	.625	.219	18188 ALLL7	P	NBR
.375	.687	.156	375-687-156EVBN	VB	NBR
.375	.750	.188	6362 H1L5	SS	NBR
.375	.750	.188	6362 H1L5 PTFE	SS	N/P
.375	.750	.188	6362 H1L7	SS	NBR
.375	.750	.188	6362 H5L16	SS	FKM
.375	.750	.250	15257 5066 304	HP	FKM
.375	.750	.250	15257 5066 316	HP	FKM
.375	.750	.250	375-750-250ETBN	TB	NBR
.375	.750	.250	TMAL 0750-1612	TMAL	PTFE
.375	.750	.250	TN 0750-1612	TN	N/P
.375	.875	.250	375-875-250ETBN	TB	NBR
.375	.875	.250	TN 0875-1616	TN	N/P
.375	.875	.250	TN 0875-1616 RL	TN	F/P
.375	.875	.250	TNV 0875-1616	TN	N/P
.375	.875	.250	TNV0875-1616304	TN	F/P
.375	.875	.250	TNV0875-1616316	TN	F/P
.375	.999	.250	375-999-250ETBN	TB	NBR
.375	1.000	.250	TN 1000-1620	TN	N/P
.375	1.000	.250	TNV 1000-1620	TN	N/P
.375	1.000	.313	5270 H1L7	SS	NBR
.375	1.124	.250	375-1124-250ETBN	TB	NBR
.375	1.125	.312	TMAL 1125-2024	TMAL	PTFE
.375	1.125	.312	TMAS 1125-2024	TMAS	PTFE
.375	1.125	.375	5110 H1L5	SS	NBR
.375	1.180	.313	12276 ALL5202	LPD	FKM
.375	1.180	.313	12276 H1L5	LPD	NBR

Shaft Dia.	Bore Dia.	Seal Width	Parker Part Number	Seal Type	Material
.375	1.180	.313	12276 H5L16	LPD	FKM
.375	1.188	.313	16314 ALLL5	LUP	NBR
.375	1.250	.313	18159 H1L5	LUP	NBR
.379	1.129	.312	TMAL 1129-2024	TMAL	PTFE
.379	1.129	.312	TMAS 1129-2024	TMAS	PTFE
.379	1.129	.375	TMAL 1129-2424	TMAL	PTFE
.394	.866	.275	16513 H1L7	P	NBR
.394	1.575	.354	15592 H1L5	SSW	NBR
.397	.866	.250	TMAL 0866-1615	TMAL	PTFE
.438	1.000	.250	TNV 1000-1618	TN	N/P
.438	.688	.188	8970 H1L7	SS	NBR
.438	.750	.250	9117 H3L8	SS	CR
.438	.875	.250	438-875-250ETBN	TB	NBR
.438	.875	.313	14657 H1L7	SS	NBR
.438	.875	.313	14657 H5L89	SS	FKM
.438	.938	.219	5864 H1L7	SS	NBR
.438	.999	.375	438-999-375ETBN	TB	NBR
.438	1.000	.250	16426 H1L7	SS	NBR
.438	1.000	.250	16426 H1L7 PTFE	SS	N/P
.438	1.000	.250	16426 H5L16	SS	FKM
.438	1.000	.313	16769 H1L7	SS	NBR
.438	1.250	.250	18397 H1L5	LDS	NBR
.448	1.375	.250	19176 H5L16	LUP	FKM
.469	1.000	.313	15026 H1L7	SS	NBR
.472	.944	.275	14725 H1L7	P	NBR
.472	1.125	.375	10891 H1L7	SS	NBR
.475	1.375	.313	12275 H1L5	LUP	NBR
.477	1.259	.281	TMAL 1259-1825	TMAL	PTFE
.500	.688	.094	500-688-94EVBN	VB	NBR
.500	.750	.125	500-750-125EVBN	VB	NBR
.500	.750	.140	11124 H1L5	SS	NBR
.500	.750	.140	11124 H3L8	SS	CR
.500	.844	.225	19798 H5L16	SS	FKM
.500	.865	.250	19828 H5MX5489	SS	FKM
.500	.875	.125	500-875-125EVBN	VB	NBR
.500	.875	.250	17801 5066 304	HP	FKM
.500	.875	.250	17801 5066 316	HP	FKM
.500	.875	.250	12705 ALLL16	MP	FKM
.500	.875	.250	12705 ALLL5	MCL	NBR
.500	.875	.250	12705 ALLL7	MCL	NBR
.500	.875	.312	12244 H1L7	SS	NBR
.500	.875	.312	TMAL 0875-2012	TMAL	PTFE
.500	.875	.313	500-875-313ETBN	TB	NBR
.500	.878	.219	14488 H1L7	SS	NBR
.500	.878	.219	9212 H1L7	SS	NBR
.500	.878	.219	9212 H5L16	SS	FKM
.500	.878	.219	9212 MX5489	SS	FKM
.500	.906	.188	5899 H1L7	SS	NBR
.500	.999	.188	500-999-188EVBN	VB	NBR
.500	.999	.250	500-999-250ETBN	TB	NBR
.500	1.000	.188	4810 H1L7	SS	NBR
.500	1.000	.188	4810 H5L16	SS	FKM
.500	1.000	.203	TMAS 1000-1316	TMAS	PTFE
.500	1.000	.250	0050 7158	SPLIT	NBR
.500	1.000	.250	15059 5066	HP	FKM
.500	1.000	.250	15059 5066 304	HP	FKM
.500	1.000	.250	15059 5066 316	HP	FKM
.500	1.000	.250	15059 HP EPDM	HP	EPDM
.500	1.000	.250	16343 H5L16	SDS	FKM
.500	1.000	.250	19745 H1L5 PTFE	SS	N/P

See Section 4 for seal type description. For High Misalignment sizes, see Page B-86. For FlexiSeal Listings, see Pages B-93 and B-97.

03/03/06



Rotary Lip Seal Inch Sizes

.500 to .625

B

Shaft Dia.	Bore Dia.	Seal Width	Parker Part Number	Seal Type	Material
.500	1.000	.250	TMAL 1000-1616	TMAL	PTFE
.500	1.000	.250	TN 1000-1616	TN	N/P
.500	1.000	.250	TNV 1000-1616	TN	N/P
.500	1.000	.313	13778 H1L7	SS	NBR
.500	1.000	.313	14806 H1L5	LUP	NBR
.500	1.000	.313	14806 H5L16	LUP	FKM
.500	1.000	.313	TMAS 1000-2016	TMAS	PTFE
.500	1.000	.375	5473 H1L7	SS	NBR
.500	1.000	.375	5473 H1L7 PTFE	SS	N/P
.500	1.063	.188	5845 H1L7	SS	NBR
.500	1.124	.250	500-1124-250ETBN	TB	NBR
.500	1.125	.250	TN 1125-1620	TN	N/P
.500	1.125	.250	TNB 1125-1620	TN	N/P
.500	1.125	.250	TNV 1125-1620	TN	N/P
.500	1.125	.312	12038 H1L5	LUP	NBR
.500	1.125	.312	12038 H5L16	LUP	FKM
.500	1.125	.375	13163 H1L5	LPD	NBR
.500	1.125	.375	5268 H1L5	SS	NBR
.500	1.125	.375	5268 H1L7	SS	NBR
.500	1.125	.375	5268 H5L16	SS	FKM
.500	1.128	.313	5883 H1L7	SS	NBR
.500	1.250	.250	19538 H1L5	LUP	NBR
.500	1.250	.250	500-1250-250ETBN	TB	NBR
.500	1.250	.250	TMAL 1250-1624	TMAL	PTFE
.500	1.250	.312	13448 H1L5	LUP	NBR
.500	1.250	.312	13448 H5L16	LUP	FKM
.500	1.250	.313	5135 H1L7	SS	NBR
.500	1.375	.250	20689 9010L21	LUP	EPDM
.500	1.375	.250	500-1375-250ETBN	TB	NBR
.500	1.375	.406	19619 H1L5	LUP	NBR
.500	1.375	.406	19619 H5L89	LUP	FKM
.500	1.375	.406	19619 MX9010L21	LUP	EPDM
.500	1.375	.406	8855 H1L7	SS	NBR
.500	1.375	.406	8855 H1L7 PTFE	SS	N/P
.530	1.250	.250	20417 H1L7 PTFE	SS	N/P
.531	1.250	.375	12934 H1L7	SS	NBR
.532	1.032	.250	0053 7158	SPLIT	NBR
.562	1.000	.218	5850 H1L7	SS	NBR
.562	1.000	.218	5850 H1L7 PTFE	SS	N/P
.562	1.000	.250	20408 H1L5	LUP	NBR
.562	1.000	.375	6069 H1L7	SS	NBR
.562	1.125	.313	12337 H1L5	LUP	NBR
.562	1.125	.313	12337 H1L5 PTFE	LUP	N/P
.562	1.125	.313	12337 H5L16	LUP	FKM
.562	1.125	.313	12337 H5L16 PTFE	LUP	F/P
.563	.875	.187	563-875-187ETBN	TB	NBR
.563	.938	.313	5196 H1L7	SS	NBR
.563	.999	.250	563-999-250ETBN	TB	NBR
.563	.999	.313	6388 H1L7	SS	NBR
.563	1.063	.250	0056 7158	SPLIT	NBR
.563	1.063	.313	5349 H1L7	SS	NBR
.563	1.124	.250	563-1124-250ETBN	TB	NBR
.563	1.125	.250	TN 1125-1618	TN	N/P
.563	1.125	.250	TNV 1125-1618	TN	N/P
.563	1.125	.250	19513	MP	FKM
.563	1.125	.281	15805 5066	HP	FKM
.563	1.125	.281	15805 5066 304	HP	FKM
.563	1.125	.281	15805 5066 316	HP	FKM
.563	1.125	.313	5239 H1L7	SS	NBR
.563	1.125	.344	0056 10532	SPLIT	NBR
.563	1.247	.375	15213 H1L5	LPD	NBR
.563	1.247	.375	15213 H5L16	LPD	FKM
.563	1.250	.250	563-1250-250ETBN	TB	NBR
.563	1.375	.312	14981 H1L5	LPD	NBR
.563	1.375	.312	14981 H1L5 PTFE	LPD	FKM
.570	1.125	.250	19319 H5L16	LUP	FKM

Shaft Dia.	Bore Dia.	Seal Width	Parker Part Number	Seal Type	Material
.588	1.125	.344	4851 H1L7	SS	NBR
.590	1.378	.375	6570 H1L5	LPD	NBR
.591	1.063	.250	7124 H1L7	SS	NBR
.591	1.063	.354	15476 ALLL7	P	NBR
.591	1.063	.354	15476 H1L7	P	NBR
.594	1.094	.250	17276 H1L5	LUP	NBR
.594	1.157	.344	0059 10532	SPLIT	NBR
.594	1.375	.375	5138 H1L7	SS	NBR
.620	1.188	.375	9553 H1L5	LPD	NBR
.624	.866	.193	19686 H1L70	SS	NBR
.625	.875	.156	11125 H1L7	SS	NBR
.625	.875	.156	11125 H3L8	SS	CR
.625	.875	.156	11125 H5L16	SS	FKM
.625	.879	.234	12312 ALLL7	P	NBR
.625	.936	.156	6189 H1L7	SS	NBR
.625	.936	.156	6189 H3L8	SS	CR
.625	.999	.250	625-999-250ETBN	TB	NBR
.625	1.000	.125	625-1000-125EVBN	VB	NBR
.625	1.000	.187	TMAS 1000-1212	TMAS	PTFE
.625	1.000	.188	11327 H1L2160	SS	EPDM
.625	1.000	.188	11327 H1L7	SS	NBR
.625	1.000	.188	11327 H5L16	SS	FKM
.625	1.063	.250	5139 H1L7	SS	NBR
.625	1.063	.250	5139 H5L16	SS	FKM
.625	1.063	.250	625-1063-250ETBN	TB	NBR
.625	1.063	.250	625-1063-250EVBN	VB	NBR
.625	1.124	.250	625-1124-250ETBN	TB	NBR
.625	1.124	.344	19631 H5L16	SPCL	FKM
.625	1.124	.344	19631 H5MX5489	SPCL	FKM
.625	1.124	.375	13059 H1L5	LUP	NBR
.625	1.124	.375	13059 H5L16	LUP	FKM
.625	1.125	.250	18020 5066	HP	FKM
.625	1.125	.250	18020 5066 304	HP	FKM
.625	1.125	.250	18020 5066 316	HP	FKM
.625	1.125	.250	9634 H1L5	LUP	NBR
.625	1.125	.250	9634 H1L5 PTFE	LUP	N/P
.625	1.125	.250	9634 H1L70	LUP	NBR
.625	1.125	.250	9634 H1L70 PTFE	LUP	N/P
.625	1.125	.250	9634 H5L16	LUP	FKM
.625	1.125	.250	9634 H5L16 PTFE	LUP	F/P
.625	1.125	.250	7158 H1L5	RUP	NBR
.625	1.125	.250	7158 H1L5 PTFE	RUP	N/P
.625	1.125	.250	7158 H5L16	RUP	FKM
.625	1.125	.250	0062 9237	SPLIT	NBR
.625	1.125	.250	TMAL 1125-1616	TMAL	PTFE
.625	1.125	.250	TN 1125-1616	TN	N/P
.625	1.125	.250	TNB 1125-1616	TN	N/P
.625	1.125	.250	TNV 1125-1616	TN	N/P
.625	1.125	.281	19153	MP	FKM
.625	1.125	.291	19153 ALLL5	LDS	NBR
.625	1.125	.312	9569 H1L5	LUP	NBR
.625	1.125	.312	9569 H5MX5489	LUP	FKM
.625	1.125	.313	0062 9956	SPLIT	NBR
.625	1.125	.312	5084 H1L5 PTFE	SS	N/P
.625	1.125	.312	5084 H1L7	SS	NBR
.625	1.125	.312	5084 H5L16	SS	FKM
.625	1.125	.375	5152 H1L5	LA	NBR
.625	1.125	.375	5152 H5L16	LA	FKM
.625	1.125	.375	5152 H5L16 PTFE	LA	F/P
.625	1.125	.375	18459 H1L5	LUP	NBR
.625	1.125	.375	6093 H1L5 PTFE	SS	N/P
.625	1.125	.375	6093 H1L7	SS	NBR
.625	1.125	.406	13914 H1L5	LUP	NBR
.625	1.181	.406	9756 H1L5	LUP	NBR
.625	1.188	.344	0062 10532	SPLIT	NBR
.625	1.250	.250	625-1250-250ETBN	TB	NBR

See Section 4 for seal type description. For High Misalignment sizes, see Page B-86. For FlexiSeal Listings, see Pages B-93 and B-97.

03/03/06



B

Shaft Dia.	Bore Dia.	Seal Width	Parker Part Number	Seal Type	Material
.625	1.250	.312	15598 5066	HP	FKM
.625	1.250	.312	15598 5066 304	HP	FKM
.625	1.250	.312	15598 5066 316	HP	FKM
.625	1.250	.313	9684 H1L5	LPD	NBR
.625	1.250	.313	9684 H1L5 PTFE	LPD	N/P
.625	1.250	.313	9684 H5L16	LPD	FKM
.625	1.250	.313	0625 9956	SPLIT	NBR
.625	1.250	.375	6313 H1L5	LUP	NBR
.625	1.250	.375	6313 H5L16	LUP	FKM
.625	1.250	.375	5410 H1L7	SS	NBR
.625	1.375	.250	625-1375-250ETBN	TB	NBR
.625	1.375	.312	TMAL 1375-2024	TMAL	PTFE
.625	1.375	.375	12876 H1L5	LUP	NBR
.625	1.375	.375	12876 H1L5 PTFE	LUP	N/P
.625	1.375	.375	12876 H5L16	LUP	FKM
.625	1.375	.438	4880 H1L5	LUP	NBR
.625	1.378	.250	19620 H1L5 PTFE	SS	N/P
.625	1.378	.313	5506 H1L7	SS	NBR
.625	1.499	.250	625-1499-250ETBN	TB	NBR
.625	1.500	.438	9152 H1L5	LUP	NBR
.625	1.624	.312	625-1624-312ETBN	TB	NBR
.625	1.850	.438	11052 H1L5	LPD	NBR
.625	1.850	.438	11052 H5L16	LPD	FKM
.630	1.102	.275	14724 H1L5	P	NBR
.655	1.124	.296	TMAL 1124-1915	TMAL	PTFE
.656	1.124	.250	656-1124-250ETBN	TB	NBR
.656	1.128	.250	5591 H1L7	SS	NBR
.656	1.250	.250	656-1250-250ETBN	TB	NBR
.656	1.250	.312	13135 H1L5	LPD	NBR
.656	1.375	.312	5831 H1L5	LUP	NBR
.656	1.375	.312	5831 H5L16	LUP	FKM
.656	1.375	.313	656-1375-313ETBN	TB	NBR
.656	1.375	.375	13469 H1L5	LPD	NBR
.656	1.375	.438	4789 H1L7	SS	NBR
.656	1.575	.312	9305 H1L5	LUP	NBR
.657	1.157	.250	0065 9237	SPLIT	NBR
.657	1.282	.313	0065 9956	SPLIT	NBR
.667	1.000	.188	11474	SS	NBR
.667	1.250	.375	5151	SS	NBR
.668	1.500	.375	5984 H1L5	LPD	NBR
.669	1.575	.250	TN 1575-1629	TN	N/P
.669	1.575	.250	TNB 1575-1629	TN	N/P
.669	1.575	.250	TNV 1575-1629	TN	N/P
.669	1.062	.125	17777 H3L8	SS	CR
.669	1.169	.250	0066 9237	SPLIT	NBR
.669	1.187	.203	669-1187-203ESAN	SA	NBR
.669	1.502	.297	6575 H1L7	SDS	NBR
.669	1.575	.438	6439 H1L7	SS	NBR
.669	1.575	.438	6439 H3L8	SS	CR
.670	1.575	.250	10336 H1L5	LUP	NBR
.680	1.246	.250	12274 H1L5	LPD	NBR
.687	1.187	.250	19785 H1L5	LUP	NBR
.687	1.500	.375	TMAL 1500-2426	TMAL	PTFE
.688	1.125	.187	TN 1125-1214	TN	N/P
.688	1.000	.188	9984 H1L5	SDS	NBR
.688	1.124	.250	688-1124-250ETBN	TB	NBR
.688	1.125	.188	19726 H1L5 PTFE	SS	N/P
.688	1.125	.344	5305 H1L5 PTFE	SS	N/P
.688	1.125	.344	5305 H1L7	SS	NBR
.688	1.125	.375	9113 H1L5	LPD	NBR
.688	1.125	.375	9113 H5L16	LPD	FKM
.688	1.188	.188	688-1188-188ETBN	TB	NBR
.688	1.188	.250	0068 9237	SPLIT	NBR
.688	1.250	.313	688-1250-313ETBN	TB	NBR
.688	1.250	.344	10532 H1L5	RPD	NBR
.688	1.250	.375	4793	SS	NBR

Shaft Dia.	Bore Dia.	Seal Width	Parker Part Number	Seal Type	Material
.688	1.250	.375	0068 9834	SPLIT	NBR
.688	1.313	.313	0068 9956	SPLIT	NBR
.688	1.375	.125	688-1375-125EVBN	VB	NBR
.688	1.375	.312	10904 H1L5	LUP	NBR
.688	1.375	.312	10904 H5L89	LUP	FKM
.688	1.375	.313	688-1375-313ETBN	TB	NBR
.688	1.375	.344	15384 5066	HP	FKM
.688	1.375	.344	15384 5066 304	HP	FKM
.688	1.375	.344	15384 5066 316	HP	FKM
.688	1.375	.406	6851 H1L5	LUP	NBR
.688	1.499	.250	688-1499-250ETBN	TB	NBR
.688	1.688	.437	TMAL 1688-2832	TMAL	PTFE
.719	1.250	.313	16081 H1L5	LUP	NBR
.719	1.282	.375	0071 9834	SPLIT	NBR
.739	2.375	.188	11228	DS	NBR
.743	1.010	.188	5550 H3L8	SS	CR
.745	1.374	.313	9239 H1L5	LPD	NBR
.747	1.575	.438	6440 H1L7	SS	NBR
.750	1.000	.125	750-1000-125EVBN	VB	NBR
.750	1.004	.234	12311 ALLL16	P	FKM
.750	1.004	.234	12311 ALLL7	P	NBR
.750	1.062	.188	750-1062-188ETBN	TB	NBR
.750	1.124	.156	750-1124-156EVBN	VB	NBR
.750	1.125	.187	TN 1125-1212	TN	N/P
.750	1.125	.187	TNA 1125-1212	TN	N/P
.750	1.125	.250	6268 H1L7	SS	NBR
.750	1.125	.250	6268 H1L7 PTFE	SS	N/P
.750	1.125	.250	6268 H5L16	SS	FKM
.750	1.125	.250	750-1125-250ETCN	TC	NBR
.750	1.125	.250	TMAL 1125-1612	TMAL	PTFE
.750	1.125	.375	5195 H1L7	SS	NBR
.750	1.187	.250	750-1187-250EVBN	VB	NBR
.750	1.250	.125	5992 H1L5	SS	NBR
.750	1.250	.125	5992 H5L16	SS	FKM
.750	1.250	.250	16204 H1L7	H	NBR
.750	1.250	.250	15487 5066	HP	FKM
.750	1.250	.250	15487 5066 304	HP	FKM
.750	1.250	.250	15487 5066 316	HP	FKM
.750	1.250	.250	15487 5066304PT	HP	F/P
.750	1.250	.250	0502 LDN 250 00750 250 VN	LDN	PTFE
.750	1.250	.250	14797 H1L5	LDS	NBR
.750	1.250	.250	14797 H1L70	LDS	NBR
.750	1.250	.250	14797 H5L16	LDS	FKM
.750	1.250	.250	9651 H1L5	LUP	NBR
.750	1.250	.250	9651 H1L7	LUP	NBR
.750	1.250	.250	9651 H5L16	LUP	FKM
.750	1.250	.250	9237 H1L5	RUP	NBR
.750	1.250	.250	9237 H1L5 PTFE	RUP	N/P
.750	1.250	.250	9237 H5L16	RUP	FKM
.750	1.250	.250	5166 H1L5 PTFE	SS	N/P
.750	1.250	.250	5166 H1L7	SS	NBR
.750	1.250	.250	5166 H1L7 PTFE	SS	N/P
.750	1.250	.250	5166 H5L16	SS	FKM
.750	1.250	.250	5166 H5L16 PTFE	SS	F/P
.750	1.250	.250	750-1250-250ETBN	TB	NBR
.750	1.250	.250	TMAS 1250-1616	TMAS	PTFE
.750	1.250	.250	TN 1250-1616	TN	N/P
.750	1.250	.250	TNV 1250-1616	TN	N/P
.750	1.250	.250	750-1250-250EVBN	VB	NBR
.750	1.250	.312	9240 H1L5	LUP	NBR
.750	1.250	.312	9240 H1L5 PTFE	LUP	N/P
.750	1.250	.312	9240 H5L16	LUP	FKM
.750	1.250	.312	0075 4187	SPLIT	NBR
.750	1.250	.375	15439 H1L5	LUP	NBR
.750	1.250	.375	15439 H1L5 PTFE	LUP	N/P
.750	1.250	.375	15439 H1LF PTFE	LUP	N/P

See Section 4 for seal type description. For High Misalignment sizes, see Page B-86. For FlexiSeal Listings, see Pages B-93 and B-97.

03/03/06



Rotary Lip Seal Inch Sizes

.750 to .875

B

Shaft Dia.	Bore Dia.	Seal Width	Parker Part Number	Seal Type	Material
.750	1.252	.250	0502 LDN 251 00750 250 VN	LDN	PTFE
.750	1.252	.188	750-1252-188ESBN	SB	NBR
.750	1.299	.275	17542 H1L7	P	NBR
.750	1.312	.250	0502 LDN 281 00750 250 VN	LDN	PTFE
.750	1.312	.250	750-1312-250ETBN	TB	NBR
.750	1.313	.375	0075 9834	SPLIT	NBR
.750	1.374	.125	18527 H1L5	SS	NBR
.750	1.375	.250	0502 LDN 313 00750 250 VN	LDN	PTFE
.750	1.375	.250	19582 H1L21	LDS	EPDM
.750	1.375	.250	19582 H1L5	LDS	NBR
.750	1.375	.250	750-1375-250ETBN	TB	NBR
.750	1.375	.312	9377 H1L5	LUP	NBR
.750	1.375	.312	9377 H1L5 PTFE	LUP	N/P
.750	1.375	.312	9377 H1L7	LUP	NBR
.750	1.375	.312	9377 H5L16	LUP	FKM
.750	1.375	.312	TMAL 1375-2020	TMAL	PTFE
.750	1.375	.313	9956 H1L5	RUP	NBR
.750	1.375	.375	13580 H1L5	LPD	NBR
.750	1.375	.375	13580 H5L16	LPD	FKM
.750	1.375	.406	17698 5066	HP	FKM
.750	1.375	.406	17698 5066 304	HP	FKM
.750	1.375	.406	17698 5066 316	HP	FKM
.750	1.375	.406	8463 H1L5	LPD	NBR
.750	1.499	.250	0502 LDN 375 00750 250 VN	LDN	PTFE
.750	1.499	.250	750-1499-250ETBN	TB	NBR
.750	1.500	.297	6531 H1L7	SS	NBR
.750	1.500	.310	13068 H1L5	LUP	NBR
.750	1.500	.310	13068 H1L5 PTFE	LUP	N/P
.750	1.500	.310	13068 H5L16	LUP	FKM
.750	1.500	.312	18935 ALLL5	MCL	NBR
.750	1.500	.360	6932 H1L5	LA	NBR
.750	1.500	.360	6932 H5L16	LA	FKM
.750	1.500	.375	12564 H1L5	LDS	NBR
.750	1.500	.375	12564 H5L16	LDS	FKM
.750	1.500	.375	6418 H1L5 PTFE	SS	N/P
.750	1.500	.375	6418 H1L7	SS	NBR
.750	1.500	.375	6418 H1L7 PTFE	SS	N/P
.750	1.500	.375	6418 H5L16	SS	FKM
.750	1.500	.375	TMAL 1500-2424	TMAL	PTFE
.750	1.500	.406	9992 H1L5	LPD	NBR
.750	1.500	.406	9992 H5L16	LPD	FKM
.750	1.624	.250	0502 LDN 437 00750 250 VN	LDN	PTFE
.750	1.624	.250	750-1624-250ETBN	TB	NBR
.750	1.625	.250	19697 H1L5 PTFE	SS	N/P
.750	1.625	.250	TMAS 1625-1628	TMAS	PTFE
.750	1.625	.250	TN 1625-1628	TN	N/P
.750	1.625	.250	TNV 1625-1628	TN	N/P
.750	1.625	.312	9339 H1L3 PTFE	LUP	CR/PTFE
.750	1.625	.312	9339 H1L5	LUP	NBR
.750	1.625	.312	9339 H5L16	LUP	FKM
.750	1.750	.250	12445 414	DS	CR
.750	1.750	.375	9983 H1L5	LUP	NBR
.750	1.750	.375	9983 H1L5 PTFE	LUP	N/P
.750	1.750	.375	9983 H5MX5489	LUP	FKM
.750	1.851	.375	14909 H1L5	LPD	NBR
.750	1.851	.375	14909 H5L16	LPD	FKM
.750	2.000	.200	13302 444	DS	NBR
.750	2.250	.200	13726 414	DS	CR
.750	2.781	.300	13307 ALLL5	MISC	NBR
.750	4.038	.344	20436 ALLL5	SPEC	NBR
.781	1.063	.250	11317 H3L8	SS	CR
.781	1.125	.375	14916 ALLL3	SS	CR
.781	1.281	.313	5189 H1L5	LUP	NBR
.781	1.281	.313	5189 H1L5 PTFE	LUP	N/P
.781	1.375	.406	18798 H1L5	LUP	NBR
.781	1.375	.406	18798 H5L16	LUP	FKM

Shaft Dia.	Bore Dia.	Seal Width	Parker Part Number	Seal Type	Material
.781	1.499	.250	0502 LDN 359 00781 250 VN	LDN	PTFE
.781	1.499	.313	781-1499-313ETBN	TB	NBR
.781	1.750	.313	18716 5066	HP	FKM
.781	1.750	.313	18716 5066 304	HP	FKM
.781	1.750	.313	18716 5066 316	HP	FKM
.781	1.756	.300	19632 H5L16	SDS	FKM
.781	1.756	.300	19632 H5MX5489	SDS	FKM
.781	1.375	.250	TN 1375-1619	TN	N/P
.781	1.375	.250	TNV 1375-1619	TN	N/P
.782	1.282	.312	0078 4187	SPLIT	NBR
.787	1.124	.188	787-1124-188ETBN	TB	NBR
.787	1.260	.335	14779 H1L5	LPD	NBR
.787	1.260	.354	15858 H1L7	P	NBR
.787	1.299	.275	13764 H1L7	P	NBR
.787	1.654	.250	19655 H1L5 PTFE	SS	N/P
.787	1.850	.531	11903 H1L5	LUP	NBR
.791	1.062	.250	19618	MP	FKM
.804	1.375	.313	11924 H1L5	LPD	NBR
.806	1.306	.312	0080 4187	SPLIT	NBR
.812	1.250	.188	6159 H1L7	SS	NBR
.812	1.250	.312	5292 H1L7	SS	NBR
.812	1.375	.312	9743 H1L5	LPD	NBR
.812	1.375	.312	9743 H5L16	LPD	FKM
.812	1.375	.375	9834 H1L5	RPD	NBR
.813	1.375	.250	TN 1375-1618	TN	N/P
.813	1.250	.188	813-1250-188ETBN	TB	NBR
.813	1.313	.312	0081 4187	SPLIT	NBR
.813	1.313	.313	19758 H1L5	LUP	NBR
.813	1.375	.313	10403 H1L5	LPD	NBR
.813	1.500	.391	7348 H1L5	LPD	NBR
.813	1.500	.391	7348 H5L16	LPD	FKM
.813	1.624	.250	0502 LDN 406 00813 250 VN	LDN	PTFE
.813	1.624	.250	813-1624-250ETBN	TB	NBR
.813	1.625	.310	15451 H1L5	LPD	NBR
.813	1.625	.438	12406 H1L5	LPD	NBR
.813	1.752	.375	13438 H1L5	LPD	NBR
.813	1.875	.431	13647 H1L5	LPD	NBR
.840	1.344	.250	4692 H1L5	B	NBR
.844	1.344	.312	0084 4149	SPLIT	NBR
.844	1.500	.375	13062 H1L5	LPD	NBR
.844	1.575	.313	6628 H1L7	SS	NBR
.860	1.260	.276	17420 H1L7	SS	NBR
.860	1.260	.276	17420 H3L8	SS	CR
.860	1.338	.275	14726 H1L7	P	NBR
.860	1.375	.188	5963 H1L7	SS	NBR
.860	1.378	.276	16077 H1L7	P	NBR
.860	1.378	.276	16077 H5L16	P	FKM
.865	1.380	.312	19514	MP	FKM
.866	1.575	.265	19392	MP	FKM
.870	1.330	.230	18985 H1L5	P	NBR
.870	1.500	.250	19668 H1L5	SS	NBR
.872	1.500	.375	16463 H1L5	LDS	NBR
.872	1.500	.375	16463 H5L16	LDS	FKM
.875	1.125	.125	875-1125-125EYBN	VB	NBR
.875	1.125	.188	15797 H1L7	SS	NBR
.875	1.125	.188	15797 H1L7 PTFE	SS	N/P
.875	1.125	.234	12310 ALLL7	P	NBR
.875	1.250	.188	19690 H1L70 PTF	SS	N/P
.875	1.250	.188	6158 H1L7	SS	NBR
.875	1.250	.188	6158 H5L16	SS	FKM
.875	1.250	.188	6158 H5MX5489	SS	FKM
.875	1.250	.188	875-1250-188ETBN	TB	NBR
.875	1.250	.188	TN 1250-1212	TN	N/P
.875	1.250	.188	TNA 1250-1212	TN	N/P
.875	1.250	.218	5118 H1L7	SS	NBR
.875	1.250	.218	5118 H5L16	SS	FKM

See Section 4 for seal type description. For High Misalignment sizes, see Page B-86. For FlexiSeal Listings, see Pages B-93 and B-97.

03/03/06



B

Shaft Dia.	Bore Dia.	Seal Width	Parker Part Number	Seal Type	Material
.875	1.250	.250	6499 H1L7	SS	NBR
.875	1.250	.250	6499 H1L7 PTFE	SS	N/P
.875	1.250	.250	6499 H5L89	SS	FKM
.875	1.375	.188	875-1375-188EVB	VB	NBR
.875	1.375	.250	15378 5066	HP	FKM
.875	1.375	.250	15378 5066 304	HP	FKM
.875	1.375	.250	15378 5066 316	HP	FKM
.875	1.375	.250	0502 LDN 250 00875 250 VN	LDN	PTFE
.875	1.375	.250	5660 H1L5	LUP	NBR
.875	1.375	.250	5660 H1L5 PTFE	LUP	N/P
.875	1.375	.250	5660 H5L16	LUP	FKM
.875	1.375	.250	19547	SS	N/P
.875	1.375	.250	875-1375-250ETBN	TB	NBR
.875	1.375	.250	TNV 1375-1616	TN	N/P
.875	1.375	.260	19972 H1L7 PTFE	SS	N/P
.875	1.375	.296	TMAL 1375-1916	TMAL	PTFE
.875	1.375	.312	9415 H1L5	LPD	NBR
.875	1.375	.312	9415 H5L16	LPD	FKM
.875	1.375	.312	4187 H1L5	RUP	NBR
.875	1.375	.312	0087 4149	SPLIT	NBR
.875	1.375	.312	0087 4149 V	SPLIT	FKM
.875	1.375	.312	6133 H1L7	SS	NBR
.875	1.375	.312	6133 H5L16	SS	FKM
.875	1.375	.312	TMAL 1375-2016	TMAL	PTFE
.875	1.375	.375	6988 H1L5	LPD	NBR
.875	1.375	.375	6988 H1L5 PTFE	LPD	N/P
.875	1.375	.406	9421 H1L5	LPD	NBR
.875	1.375	.406	9421 H5L16	LPD	FKM
.875	1.375	.406	9421 H5L89	LPD	FKM
.875	1.438	.313	19339 H1L5	LUP	NBR
.875	1.438	.313	19339 H5L16	LUP	FKM
.875	1.499	.250	0502 LDN 312 00875 250 VN	LDN	PTFE
.875	1.499	.250	875-1499-250ETBN	TB	NBR
.875	1.500	.250	TMAS 1500-1620	TMAS	PTFE
.875	1.500	.313	18855 5066	HP	FKM
.875	1.500	.313	18855 5066 304	HP	FKM
.875	1.500	.375	8464 9010/L21	LUP	EPDM
.875	1.500	.375	8464 H1L5	LUP	NBR
.875	1.500	.375	8464 H1L7	LUP	NBR
.875	1.500	.375	8464 H5L16	LUP	FKM
.875	1.500	.375	5780 H1L7	SS	NBR
.875	1.500	.391	17697 5066	HP	FKM
.875	1.500	.391	17697 5066 304	HP	FKM
.875	1.500	.391	17697 5066 316	HP	FKM
.875	1.500	.406	5720 H1L5	LPD	NBR
.875	1.563	.313	10750 H1L5	LUP	NBR
.875	1.563	.313	10750 H5L16	LUP	FKM
0.875	1.624	.250	0502 LDN 375 00875 250 VN	LDN	PTFE
.875	1.624	.250	875-1624-250ETBN	TB	NBR
.875	1.625	.250	TMAL 1625-1624	TMAL	PTFE
.875	1.625	.250	TN 1625-1624	TN	N/P
.875	1.625	.250	TNV 1625-1624	TN	N/P
.875	1.625	.313	6710 H1L7	SS	NBR
.875	1.625	.375	9975 H1L5	LPD	NBR
.875	1.625	.375	9975 H5L16	LPD	FKM
.875	1.688	.375	13250 H1L5	LDS	NBR
.875	1.688	.375	13250 H1L70	LDS	NBR
.875	1.688	.375	13250 H5L16	LDS	FKM
.875	1.688	.375	12449 H1L5	LPD	NBR
.875	1.688	.375	12449 H5L89	LPD	FKM
.875	1.688	.375	0087 10161	SPLIT	NBR
.875	1.750	.218	TMAL 1750-1428	TMAL	PTFE
.875	1.750	.250	17744 ALLL5	MCL	NBR
.875	1.750	.312	TMAL 1750-2028	TMAL	PTFE
.875	1.750	.438	8465 H1L5	LPD	NBR
.875	1.750	.438	8465 H5L16	LPD	FKM

Shaft Dia.	Bore Dia.	Seal Width	Parker Part Number	Seal Type	Material
.875	1.828	.438	13581 H1L5	LPD	NBR
.875	2.063	.375	15677 H1L5	LUP	NBR
.875	2.063	.375	15677 H5L16	LUP	FKM
.875	2.250	.180	12120 H1L20PTFE	SSW	XN/P
.875	2.250	.180	12120 H1L5	SSW	NBR
.875	2.250	.180	12120 H1L5 PTFE	SSW	N/P
.875	2.750	.375	19014 H1L5	LUP	NBR
.875	2.750	.375	20415 H1L5	LUP	NBR
.897	1.250	.219	11805 H1L7	SS	NBR
.906	1.625	.312	TMAL 1625-2023	TMAL	PTFE
.907	1.407	.312	0090 4149	SPLIT	NBR
.907	1.719	.375	0090 10161	SPLIT	NBR
.910	1.625	.313	17318 H1L5	LUP	NBR
.910	1.625	.313	17318 H5L16	LUP	FKM
.931	2.000	.312	19271	MP	FKM
.938	1.375	.250	938-1375-250ETBN	TB	NBR
.938	1.438	.312	0093 4149	SPLIT	NBR
.938	1.500	.250	0502 LDN 281 00938 250 VN	LDN	PTFE
.938	1.500	.250	938-1500-250ETBN	TB	NBR
.938	1.500	.313	0093 12375	SPLIT	NBR
.938	1.500	.375	10229 H1L5	LUP	NBR
.938	1.500	.375	10229 H1L5 PTFE	LUP	N/P
.938	1.500	.375	10229 H5L16	LUP	FKM
.938	1.563	.313	0093 16621	SPLIT	NBR
.938	1.624	.250	0502 LDN 343 00938 250 VN	LDN	PTFE
.938	1.624	.250	938-1624-250ETBN	TB	NBR
.938	1.625	.312	9186 H1L5	LUP	NBR
.938	1.625	.312	9186 H1L5 PTFE	LUP	N/P
.938	1.625	.438	6800 H1L5	LPD	NBR
.938	1.688	.375	0093 16893	SPLIT	NBR
.938	1.688	.375	6728 H1L5	LA	NBR
.938	1.703	.250	11051 H5L89	LPD	FKM
.938	1.750	.312	938-1750-312ETCN	TC	NBR
.938	1.750	.371	6448 H1L5	LA	NBR
.938	1.750	.375	0093 10161	SPLIT	NBR
.938	1.750	.438	8928 H1L5	LPD	NBR
.938	1.830	.406	5880 H1L5	LPD	NBR
.938	1.830	.406	5880 H5MX5489	LPD	FKM
.938	1.875	.438	9318 H1L5	LUP	NBR
.938	2.063	.438	9219 H1L5	LPD	NBR
.941	1.220	.156	19688 H1L70	SS	NBR
.967	1.500	.375	5853 H1L5	LA	NBR
.968	1.500	.312	TMAL 1500-2017	TMAL	PTFE
.969	1.499	.250	0502 LDN 265 00969 250 VN	LDN	PTFE
.969	1.499	.313	969-1499-313ETBN	TB	NBR
.969	1.500	.313	11316 H1L7	SS	NBR
.969	1.500	.328	9744 H1L5	LUP	NBR
.969	1.500	.328	9744 H5L16	LUP	FKM
.969	1.532	.313	0096 12375	SPLIT	NBR
.969	1.594	.313	0096 16621	SPLIT	NBR
.969	1.624	.250	0502 LDN 328 00969 250 VN	LDN	PTFE
.969	1.624	.250	969-1624-250ETBN	TB	NBR
.969	1.719	.375	0096 16893	SPLIT	NBR
.969	1.828	.438	12634 H1L5	LPD	NBR
.969	1.828	.438	12634 H5L16	LPD	FKM
.969	2.000	.375	11782 H1L5	LDS	NBR
.969	2.000	.375	15456 H1L5	LPD	NBR
.969	2.000	.375	15456 H5L16	LPD	FKM
.969	2.047	.375	11425 H1L5	LPD	NBR
.969	2.047	.375	60019 H1L5	LDS	NBR
.969	2.062	.300	13667 ALLL16	MP	FKM
.969	2.063	.313	11893 H1L5	LUP	NBR
.970	1.500	.250	17998 5066 304	HP	FKM
.970	1.500	.250	17998 5066304PT	HP	F/P
.970	1.500	.250	17998 HP304EPDM	HP	EPDM
.980	2.046	.250	10335 H1L5	LUP	NBR

See Section 4 for seal type description. For High Misalignment sizes, see Page B-86.
For FlexiSeal Listings, see Pages B-93 and B-97.

03/03/06



Rotary Lip Seal Inch Sizes

.980 to 1.000

B

Shaft Dia.	Bore Dia.	Seal Width	Parker Part Number	Seal Type	Material
.980	2.046	.250	10335 H5L16	LUP	FKM
.981	1.594	.313	14038 H1L5	LPD	NBR
.982	1.750	.375	6755 H1L5	LPD	NBR
.983	1.500	.313	15490 H1L5	LUP	NBR
.983	1.500	.313	15490 H5L16	LUP	FKM
.983	1.500	.313	7116 H1L5	LUP	NBR
.983	1.500	.313	7116 H5L16	LUP	FKM
.984	1.378	.276	14589 H1L7	SS	NBR
.984	1.457	.354	15895 H1L7	P	NBR
.984	1.496	.275	14001 H1L7	P	NBR
.984	1.496	.275	14001 H5L16	P	FKM
.984	1.499	.250	0502 LDN 258 00984 250 VN	LDN	PTFE
.984	1.500	.313	5324	SS	NBR
.984	1.575	.394	14251 H1L5	LPD	NBR
.984	1.653	.393	17238 H1L21	LUP	EPDM
.984	1.653	.393	17238 H1L5	LUP	NBR
.984	1.653	.393	17238 H5L16	LUP	FKM
.984	1.750	.313	17161 5066	HP	FKM
.984	1.750	.313	17161 5066 304	HP	FKM
.984	1.750	.313	17161 5066 316	HP	FKM
.984	1.750	.313	19011 5066	HP	FKM
.984	1.850	.250	19656 H1L5 PTFE	SS	N/P
.984	1.850	.394	13044 H1L5	LPD	NBR
.984	1.850	.394	13044 H5L16	LPD	FKM
.984	1.881	.297	12077 H1L5	LUP	NBR
.984	2.047	.394	13994 H1L5	LPD	NBR
.984	2.047	.500	6726 H1L5	LA	NBR
.984	2.047	.500	6726 H5L16	LA	FKM
.985	2.047	.250	TN 2047-1634	TN	N/P
.986	1.250	.156	6387 ALLL5	SS	NBR
.986	1.250	.156	6387 H3L8	SS	CR
.986	1.250	.156	6387 H5L16	SS	FKM
.999	2.062	.375	TMAL 2062-2434	TMAL	PTFE
1.000	1.250	.125	1000-1250-125EVBN	VB	NBR
1.000	1.312	.125	1000-1312-125EVBN	VB	NBR
1.000	1.316	.281	12314 ALLL7	P	NBR
1.000	1.316	.281	12314 ALLL7 PTF	P	N/P
1.000	1.375	.187	19691 H1L70 PTF	SS	N/P
1.000	1.375	.188	13366 H1L5	H	NBR
1.000	1.375	.188	13366 H1L7	H	NBR
1.000	1.375	.188	13366 H1L7 PTFE	H	N/P
1.000	1.375	.188	13366 H1L70	H	NBR
1.000	1.375	.188	13366 H5L16	H	FKM
1.000	1.375	.250	1000-1375-250ETBN	TB	NBR
1.000	1.375	.250	TMAL 1375-1612	TMAL	PTFE
1.000	1.437	.250	1000-1437-250ETBN	TB	NBR
1.000	1.437	.250	1000-1437-250EVBN	VB	NBR
1.000	1.438	.188	5848 414	DS	CR
1.000	1.438	.312	5150 H1L7	SS	NBR
1.000	1.441	.391	5700 H1L5	SS	NBR
1.000	1.441	.391	5700 H1L7	SS	NBR
1.000	1.499	.250	0502 LDN 250 01000 250 VN	LDN	PTFE
1.000	1.499	.250	1000-1499-250ETBN	TB	NBR
1.000	1.500	.187	TMAL 1500-1216	TMAL	PTFE
1.000	1.500	.250	16205 H1L7	H	NBR
1.000	1.500	.250	16171 5066	HP	FKM
1.000	1.500	.250	16171 5066 304	HP	FKM
1.000	1.500	.250	16171 5066 316	HP	FKM
1.000	1.500	.250	10751 H1L5	LUP	NBR
1.000	1.500	.250	10751 H1L5 PTFE	LUP	N/P
1.000	1.500	.250	10751 H1L7	LUP	NBR
1.000	1.500	.250	10751 H5L16	LUP	FKM
1.000	1.500	.250	16676 H1L7	P	NBR
1.000	1.500	.250	10615 H1L2160	SS	EPDM
1.000	1.500	.250	10615 H1L5 PTFE	SS	N/P
1.000	1.500	.250	10615 H1L7	SS	NBR

Shaft Dia.	Bore Dia.	Seal Width	Parker Part Number	Seal Type	Material
1.000	1.500	.250	10615 H5L16	SS	FKM
1.000	1.500	.250	19784 H1L5 PTFE	SS	N/P
1.000	1.500	.250	TMAL 1500-1616	TMAL	PTFE
1.000	1.500	.250	TN 1500-1616	TN	N/P
1.000	1.500	.250	TNV 1500-1616	TN	N/P
1.000	1.500	.250	1000-1500-250EVBN	VB	NBR
1.000	1.500	.312	9859 H1L5	LUP	NBR
1.000	1.500	.312	9859 H1L5 PTFE	LUP	N/P
1.000	1.500	.312	9859 H5L16	LUP	FKM
1.000	1.500	.312	4149 H1L5	RPD	NBR
1.000	1.500	.312	4149 H5L16	RPD	FKM
1.000	1.500	.312	TMAL 1500-2016	TMAL	PTFE
1.000	1.500	.375	14058 H1L5	LUP	NBR
1.000	1.500	.375	14058 H1L5 PTFE	LUP	N/P
1.000	1.500	.375	18460	LUP	NBR
1.000	1.500	.375	TMAS 1500-2416	TMAS	PTFE
1.000	1.500	.390	17694 H1L5	LDS	NBR
1.000	1.500	.390	17694 H5L16	LDS	FKM
1.000	1.500	.390	TMAL 1500-2516	TMAL	PTFE
1.000	1.500	.391	6084 H1L5	LUP	NBR
1.000	1.500	.391	6084 H5L16	LUP	FKM
1.000	1.503	.250	6583 H1L7	SS	NBR
1.000	1.503	.391	6015	SS	NBR
1.000	1.561	.250	1000-1561-250EVBN	VB	NBR
1.000	1.563	.188	12857 H1L5	OLSS	NBR
1.000	1.563	.188	12857 H5L16	OLSS	FKM
1.000	1.563	.313	0100 12375	SPLIT	NBR
1.000	1.563	.344	16447 H1L5	LUP	NBR
1.000	1.563	.375	12489 H1L5	LUP	NBR
1.000	1.575	.250	0502 LDN 288 01000 250 VN	LDN	PTFE
1.000	1.575	.250	1000-1575-250ETBN	TB	NBR
1.000	1.624	.250	0502 LDN 312 01000 250 VN	LDN	PTFE
1.000	1.624	.250	1000-1624-250ETBN	TB	NBR
1.000	1.624	.250	1000-1624-250EVBN	VB	NBR
1.000	1.625	.250	8485 H1L5	LPD	NBR
1.000	1.625	.250	8485 H1L5 PTFE	LPD	N/P
1.000	1.625	.250	8485 H5L16	LPD	FKM
1.000	1.625	.250	10870 H1L5	SS	NBR
1.000	1.625	.250	10870 H1L7	SS	NBR
1.000	1.625	.250	8442 H1L7	SS	NBR
1.000	1.625	.250	8442 H1L7 PTFE	SS	N/P
1.000	1.625	.250	8442 H5L16	SS	FKM
1.000	1.625	.313	8814 H1L5	LUP	NBR
1.000	1.625	.313	8814 H5L16	LUP	FKM
1.000	1.625	.313	0100 16621	SPLIT	NBR
1.000	1.625	.375	10749 H1L5	LPD	NBR
1.000	1.625	.438	15668 H1L5	LUP	NBR
1.000	1.625	.438	15668 H5L16	LUP	FKM
1.000	1.688	.375	16464 H1L5	LDS	NBR
1.000	1.688	.375	16464 H5L16	LDS	FKM
1.000	1.750	.313	0100 6946	SPLIT	NBR
1.000	1.750	.313	0100 6946 V	SPLIT	FKM
1.000	1.750	.375	10952 H1L5	LUP	NBR
1.000	1.750	.375	10952 H1L5 PTFE	LUP	N/P
1.000	1.750	.375	10952 H1L7	LUP	NBR
1.000	1.750	.375	10952 H5L16	LUP	FKM
1.000	1.750	.375	5793 H1L7	SS	NBR
1.000	1.750	.375	5793 H1L7 PTFE	SS	N/P
1.000	1.750	.375	5793 H5L16	SS	FKM
1.000	1.752	.250	0502 LDN 376 01000 250 VN	LDN	PTFE
1.000	1.752	.250	1000-1752-250ETBN	TB	NBR
1.000	1.752	.438	13673 H1L5	LPD	NBR
1.000	1.755	.313	5986 H1L5	LA	NBR
1.000	1.781	.469	1000-1781-469EVBN	VB	NBR
1.000	1.813	.375	10161 H1L5	RPD	NBR

See Section 4 for seal type description. For High Misalignment sizes, see Page B-86. For FlexiSeal Listings, see Pages B-93 and B-97.

03/03/06



Shaft Dia.	Bore Dia.	Seal Width	Parker Part Number	Seal Type	Material
1.000	1.813	.375	10161 H5L89	RPD	FKM
1.000	1.828	.250	0502 LDN 414 01000 250 VN	LDN	PTFE
1.000	1.828	.250	1000-1828-250ETBN	TB	NBR
1.000	1.828	.375	10183 H1L5	LUP	NBR
1.000	1.828	.375	10183 H5L16	LUP	FKM
1.000	1.828	.438	13458 H1L5	LUP	NBR
1.000	1.850	.375	9257 H1L5	LUP	NBR
1.000	1.850	.375	9257 H5L16	LUP	FKM
1.000	1.874	.250	0502 LDN 437 01000 250 VN	LDN	PTFE
1.000	1.874	.250	1000-1874-250ETBN	TB	NBR
1.000	1.875	.375	TMAL 1875-2428	TMAL	PTFE
1.000	1.875	.437	TMAL 1875-2828	TMAL	PTFE
1.000	1.875	.438	6330 H1L5	LPD	NBR
1.000	1.875	.438	6330 H5L16	LPD	FKM
1.000	1.875	.438	5764 H1L7	SS	NBR
1.000	1.938	.250	0502 LDN 469 01000 250 VN	LDN	PTFE
1.000	1.938	.250	1000-1938-250ETBN	TB	NBR
1.000	1.938	.250	1000-1938-250EVBN	VB	NBR
1.000	1.983	.250	0502 LDN 492 01000 250 VN	LDN	PTFE
1.000	1.983	.313	1000-1983-313ETBN	TB	NBR
1.000	1.984	.438	5629 H1L5	LPD	NBR
1.000	1.985	.438	0100 5819	SPLIT	NBR
1.000	2.000	.250	0502 LDN 500 01000 250 VN	LDN	PTFE
1.000	2.000	.250	1000-2000-250ETBN	TB	NBR
1.000	2.000	.250	TMAL 2000-1632	TMAL	PTFE
1.000	2.000	.250	1000-2000-250EVBN	VB	NBR
1.000	2.000	.375	6007 H1L20	LUP	XNBR
1.000	2.000	.375	6007 H1L5	LUP	NBR
1.000	2.000	.375	6007 H1L5 PTFE	LUP	N/P
1.000	2.000	.375	6007 H5L16	LUP	FKM
1.000	2.000	.375	TMAL 2000-2432	TMAL	PTFE
1.000	2.000	.375	TMAS 2000-2432	TMAS	PTFE
1.000	2.000	.438	15836 H5L16	LPD	FKM
1.000	2.000	.438	9900 H1L5	LUP	NBR
1.000	2.000	.500	9520 H1L5	LUP	NBR
1.000	2.047	.375	10213 H1L5	LPD	NBR
1.000	2.047	.438	10967 H1L7	SS	NBR
1.000	2.047	.438	10967 H5L16	SS	FKM
1.000	2.062	.250	0502 LDN 531 01000 250 VN	LDN	PTFE
1.000	2.062	.250	1000-2062-250ETBN	TB	NBR
1.000	2.063	.375	8975 H1L5	LPD	NBR
1.000	2.063	.375	8975 H5L16	LPD	FKM
1.000	2.250	.250	0502 LDN 625 01000 250 VN	LDN	PTFE
1.000	2.250	.250	1000-2250-250ETBN	TB	NBR
1.000	2.250	.438	11920 H1L7	SS	NBR
1.000	2.442	.438	11054 H1L5	LUP	NBR
1.000	2.442	.438	11054 H5L16	LUP	FKM
1.031	1.575	.313	6704 H1L7	SS	FKM
1.032	1.782	.313	0103 6946	SPLIT	NBR
1.032	2.016	.438	0103 5819	SPLIT	NBR
1.037	3.625	.500	19013 H1L5	LUP	NBR
1.037	3.625	.500	19013 H5L89	LUP	FKM
1.059	1.828	.375	6424 H1L5	LA	NBR
1.059	1.828	.375	6424 H5L16	LA	FKM
1.062	1.562	.312	9013 H1L5	LUP	NBR
1.062	1.625	.312	7215 H1L5	LUP	NBR
1.062	1.625	.312	7215 H1L5 PTFE	LUP	N/P
1.062	1.625	.312	7215 H5L16	LUP	FKM
1.063	1.215	.438	13243 H1L70	LDS	NBR
1.063	1.499	.250	1063-1499-250ETBN	TB	NBR
1.063	1.563	.313	18863 5066	HP	FKM
1.063	1.563	.313	18863 5066 304	HP	FKM
1.063	1.563	.313	18863 5066 EPDM	HP	EPDM
1.063	1.624	.250	0502 LDN 281 01063 250 VN	LDN	PTFE
1.063	1.624	.250	1063-1624-250ETBN	TB	NBR
1.063	1.625	.313	12375 H1L5	RPD	NBR

Shaft Dia.	Bore Dia.	Seal Width	Parker Part Number	Seal Type	Material
1.063	1.625	.313	12375 H5L16	RPD	FKM
1.063	1.688	.313	9363 H1L5	LPD	NBR
1.063	1.688	.313	9363 H5L16	LPD	FKM
1.063	1.688	.313	16621 H1L5	RUP	NBR
1.063	1.750	.375	9276 H1L5	LPD	NBR
1.063	1.750	.375	9276 H5L16	LPD	FKM
1.063	1.752	.250	0502 LDN 345 01063 250 VN	LDN	PTFE
1.063	1.752	.250	1063-1752-250ETBN	TB	NBR
1.063	1.752	.438	6771 H1L7	SS	NBR
1.063	1.813	.250	0106 5692	SPLIT	NBR
1.063	1.813	.375	16893 H1L5	RUP	NBR
1.063	1.874	.250	0502 LDN 406 01063 250 VN	LDN	PTFE
1.063	1.874	.250	1063-1874-250ETBN	TB	NBR
1.063	1.875	.438	14672 H1L5	LPD	NBR
1.063	1.875	.438	14672 H1L5 PTFE	LPD	N/P
1.063	1.875	.438	14672 H5L16	LPD	FKM
1.063	1.875	.438	0106 3966	SPLIT	NBR
1.063	1.938	.250	13867 H1L5	LUP	NBR
1.063	1.938	.250	13867 H1L7	LUP	NBR
1.063	1.970	.250	9174 H1L7	SS	NBR
1.063	1.970	.375	9175 H1L5	LPD	NBR
1.063	1.984	.500	5723 H1L5	LUP	NBR
1.063	1.984	.500	5723 H5L89	LUP	FKM
1.063	2.000	.250	0502 LDN 469 01063 250 VN	LDN	PTFE
1.063	2.000	.250	1063-2000-250ETBN	TB	NBR
1.063	2.000	.500	5724 H1L5	LPD	NBR
1.063	2.000	.500	5724 H5L16	LPD	FKM
1.063	2.047	.438	0106 5819	SPLIT	NBR
1.063	2.125	.438	13243 H1L5	LDS	NBR
1.063	2.125	.438	13243 H5L16	LDS	FKM
1.063	2.125	.500	10433 H1L5	LPD	NBR
1.063	2.125	.500	10433 H5L16	LPD	FKM
1.063	2.438	.313	11277 H1L5	LPD	NBR
1.063	2.835	.250	0502 LDN 886 01063 250 VN	LDN	PTFE
1.063	2.835	.375	1063-2835-375ETBN	TB	NBR
1.094	1.750	.300	19374 H1L5	P	NBR
1.094	1.844	.250	0109 5692	SPLIT	NBR
1.094	1.907	.438	0109 3966	SPLIT	NBR
1.102	1.575	.354	14774 H1L7	P	NBR
1.118	1.875	.375	0118 3688	SPLIT	NBR
1.118	1.875	.375	0118 3688 V	SPLIT	FKM
1.125	1.375	.125	1125-1375-125EVBN	VB	NBR
1.125	1.375	.219	12313 ALLL7	P	NBR
1.125	1.375	.219	13187 H3L8	P	CR
1.125	1.375	.219	16195	P	NBR
1.125	1.469	.250	5035 414	DS	CR
1.125	1.499	.188	1125-1499-188ETBN	TB	NBR
1.125	1.499	.188	1125-1499-188EVBN	VB	NBR
1.125	1.540	.230	18986 H1L5	P	NBR
1.125	1.562	.188	5254 H1L7	SS	NBR
1.125	1.562	.188	5254 H5L16	SS	FKM
1.125	1.562	.250	1125-1562-250ETBN	TB	NBR
1.125	1.562	.250	1125-1562-250EVBN	VB	NBR
1.125	1.562	.375	11834 H1L7	SS	NBR
1.125	1.624	.250	0502 LDN 250 01125 250 VN	LDN	PTFE
1.125	1.624	.250	1125-1624-250ETBN	TB	NBR
1.125	1.625	.250	15385 5066	HP	FKM
1.125	1.625	.250	15385 5066 304	HP	FKM
1.125	1.625	.250	15385 5066 316	HP	FKM
1.125	1.625	.250	9625 H1L5	LUP	NBR
1.125	1.625	.250	9625 H1L5 PTFE	LUP	N/P
1.125	1.625	.250	9625 H5L16	LUP	FKM
1.125	1.625	.250	9625 H5L16 PTFE	LUP	F/P
1.125	1.625	.250	NSEC81041	SEC	NBR
1.125	1.625	.250	5307 H1L20	SS	XNBR
1.125	1.625	.250	5307 H1L7	SS	NBR



See Section 4 for seal type description. For High Misalignment sizes, see Page B-86. For FlexiSeal Listings, see Pages B-93 and B-97.

03/03/06



B

Shaft Dia.	Bore Dia.	Seal Width	Parker Part Number	Seal Type	Material
1.125	1.625	.250	5307 H1L7 PTFE	SS	N/P
1.125	1.625	.250	TMAL 1625-1616	TMAL	PTFE
1.125	1.625	.250	TMAS 1625-1616	TMAS	PTFE
1.125	1.625	.250	TN 1625-1616	TN	N/P
1.125	1.625	.250	TNV 1625-1616	TN	N/P
1.125	1.625	.312	9848 H1L5	LUP	NBR
1.125	1.625	.312	9848 H1L5 PTFE	LUP	N/P
1.125	1.625	.312	9848 H5L16	LUP	FKM
1.125	1.625	.312	0112 14627	SPLIT	NBR
1.125	1.625	.375	5371 H1L5	B	NBR
1.125	1.656	.250	11772 414	DS	CR
1.125	1.750	.250	1125-1750-250EVBN	VB	NBR
1.125	1.750	.313	16206 H1L7	H	NBR
1.125	1.750	.313	0112 6008	SPLIT	NBR
1.125	1.750	.313	10616 H1L7	SS	NBR
1.125	1.750	.375	9460 H1L5	LUP	NBR
1.125	1.750	.375	9460 H1L5 PTFE	LUP	N/P
1.125	1.750	.375	9460 H5L16	LUP	FKM
1.125	1.750	.375	9460 H5L16 PTFE	LUP	F/P
1.125	1.750	.438	17691 H1L5	LDS	NBR
1.125	1.750	.438	17691 H5L16	LDS	FKM
1.125	1.750	.500	TMAL 1750-3220	TMAL	PTFE
1.125	1.752	.250	0502 LDN 314 01125 250 VN	LDN	PTFE
1.125	1.752	.250	1125-1752-250ETBN	TB	NBR
1.125	1.781	.250	0502 LDN 328 01125 250 VN	LDN	PTFE
1.125	1.813	.375	0112 3688	SPLIT	NBR
1.125	1.813	.375	0112 3688 V	SPLIT	FKM
1.125	1.828	.250	0502 LDN 352 01125 250 VN	LDN	PTFE
1.125	1.828	.250	1125-1828-250ETBN	TB	NBR
1.125	1.828	.375	9789 H1L5	LUP	NBR
1.125	1.828	.375	9789 H1L5 PTFE	LUP	N/P
1.125	1.851	.500	9714 H1L5	LUP	NBR
1.125	1.851	.500	9714 H5MX5489	LUP	FKM
1.125	1.874	.250	0502 LDN 375 01125 250 VN	LDN	PTFE
1.125	1.874	.250	1125-1874-250ETBN	TB	NBR
1.125	1.875	.250	0112 5692	SPLIT	NBR
1.125	1.875	.313	5298 H1L7	SS	NBR
1.125	1.875	.313	5298 H5L16	SS	FKM
1.125	1.875	.313	6946 H1L5	RUP	NBR
1.125	1.875	.313	6946 H5L16	RUP	FKM
1.125	1.875	.344	19228 5066	HP	FKM
1.125	1.875	.344	19228 5066 304	HP	FKM
1.125	1.875	.375	19261	HP	FKM
1.125	1.875	.375	15837 H1L20	LPD	XNBR
1.125	1.875	.375	15837 H5L16	LPD	FKM
1.125	1.875	.375	7054 H1L5	LUP	NBR
1.125	1.875	.375	7054 H1L5 PTFE	LUP	N/P
1.125	1.875	.375	7054 H5L16	LUP	FKM
1.125	1.875	.375	0112 4030	SPLIT	NBR
1.125	1.875	.375	TMAL 1875-2424	TMAL	PTFE
1.125	1.875	.625	16849 H1L7	P	NBR
1.125	1.878	.438	15104 H1L5	LDS	NBR
1.125	1.878	.438	15104 H5L89	LDS	FKM
1.125	1.938	.375	0112 9659	SPLIT	NBR
1.125	1.938	.563	1125-1938-563EVBN	VB	NBR
1.125	1.984	.438	5583 H1L5	LPD	NBR
1.125	2.000	.250	0502 LDN 438 01125 250 VN	LDN	PTFE
1.125	2.000	.250	1125-2000-250ETBN	TB	NBR
1.125	2.000	.250	0502 LDN 438 01125 250 VN	LDN	PTFE
1.125	2.000	.375	1125-2000-375ETBN	TB	NBR
1.125	2.000	.375	TN 2000-2428	TN	N/P
1.125	2.000	.375	TNV 2000-2428	TN	N/P
1.125	2.000	.437	TMAS 2000-2828	TMAS	PTFE
1.125	2.000	.438	10406 H1L5	LPD	NBR
1.125	2.000	.438	10406 H1L5 PTFE	LPD	N/P
1.125	2.000	.438	10406 H5L16	LPD	FKM

Shaft Dia.	Bore Dia.	Seal Width	Parker Part Number	Seal Type	Material
1.125	2.000	.500	9558 H1L5	LUP	NBR
1.125	2.000	.500	9558 H5L16	LUP	FKM
1.125	2.047	.250	1125-2047-250EVBN	VB	NBR
1.125	2.051	.438	15452 H1L5	LPD	NBR
1.125	2.062	.250	0502 LDN 469 01125 250 VN	LDN	PTFE
1.125	2.062	.312	1125-2062-312ETBN	TB	NBR
1.125	2.062	.375	9650 H1L5	LUP	NBR
1.125	2.062	.375	9650 H1L5 PTFE	LUP	N/P
1.125	2.062	.375	9650 H1L7	LUP	NBR
1.125	2.062	.375	9650 H5L16	LUP	FKM
1.125	2.063	.250	17701 H1L5	LUP	NBR
1.125	2.066	.432	18854 5066	HP	FKM
1.125	2.066	.432	18854 5066 304	HP	FKM
1.125	2.067	.438	0112 18411	SPLIT	NBR
1.125	2.094	.375	11201 H1L5	LUP	NBR
1.125	2.109	.438	5819 H1L5	RPD	NBR
1.125	2.125	.250	0502 LDN 500 01125 250 VN	LDN	PTFE
1.125	2.125	.313	1125-2125-313ETBN	TB	NBR
1.125	2.125	.500	0112 17648	SPLIT	NBR
1.125	2.250	.250	0502 LDN 563 01125 250 VN	LDN	PTFE
1.125	2.250	.250	1125-2250-250ETBN	TB	NBR
1.125	2.313	.438	13369 H1L5	LDS	NBR
1.125	2.441	.250	0502 LDN 658 01125 250 VN	LDN	PTFE
1.125	2.441	.250	1125-2441-250ETBN	TB	NBR
1.125	2.441	.313	19160 H1L5	LDS	NBR
1.125	2.441	.313	19160 H5L16	LDS	FKM
1.125	2.500	.375	17990 H1L5	LUP	NBR
1.125	2.500	.375	17990 H1L5 PTFE	LUP	N/P
1.125	2.500	.375	17990 H5L16	LUP	FKM
1.125	2.835	.500	9065 H1L5	LUP	NBR
1.125	2.835	.500	9065 H5L16	LUP	FKM
1.125	2.835	.500	9065 H5MX5489	LUP	FKM
1.127	2.002	.437	TMAS 2002-2828	TMAS	PTFE
1.130	1.630	.250	TMAL 1630-1616	TMAL	PTFE
1.154	1.431	.160	17316 ALLL5	SS	NBR
1.156	1.686	.250	0502 LDN 265 01156 250 VN	LDN	PTFE
1.156	1.686	.250	1156-1686-250ETBN	TB	NBR
1.156	1.690	.313	18224 H1L5	LUP	NBR
1.156	1.693	.313	19420 5066	HP	FKM
1.156	1.875	.375	5212 H1L20	LUP	XNBR
1.156	1.875	.375	5212 H1L5	LUP	NBR
1.156	1.875	.375	5212 H5L16	LUP	FKM
1.156	2.000	.250	0502 LDN 422 01156 250 VN	LDN	PTFE
1.156	2.000	.250	1156-2000-250ETBN	TB	NBR
1.156	2.047	.375	9306 H1L5	LPD	NBR
1.156	2.047	.375	9306 H5L16	LPD	FKM
1.156	2.375	.375	11539 H1L5	LDS	NBR
1.157	1.657	.312	0115 14627	SPLIT	NBR
1.157	1.782	.313	0115 6008	SPLIT	NBR
1.157	1.844	.375	0115 3688	SPLIT	NBR
1.157	1.907	.375	0115 4030	SPLIT	NBR
1.157	1.969	.375	0115 9659	SPLIT	NBR
1.157	2.157	.500	0115 17648	SPLIT	NBR
1.168	1.945	.375	15807 H1L7	SS	NBR
1.172	1.688	.313	12632 H1L5	LPD	NBR
1.176	2.250	.290	16852 H1L5	SSW	NBR
1.176	2.250	.375	16623 H1L5	SSW	NBR
1.178	2.250	.375	17515 H1L5	LUP	NBR
1.178	2.250	.375	17515 H1L5 PTFE	LUP	N/P
1.178	2.250	.375	17515 H5L89	LUP	FKM
1.179	2.441	.375	13286 H1L5	LDS	NBR
1.179	2.441	.375	13286 H5MX5489	LDS	FKM
1.180	1.875	.250	16739 H1L5	LUP	NBR
1.180	2.047	.394	30057 H1L2160	LUP	EPDM
1.180	2.625	.375	9168 H1L5	LPD	NBR
1.180	2.625	.375	9168 H5L16	LPD	FKM

See Section 4 for seal type description. For High Misalignment sizes, see Page B-86. For FlexiSeal Listings, see Pages B-93 and B-97.

03/03/06



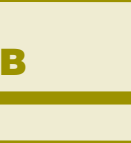

Shaft Dia.	Bore Dia.	Seal Width	Parker Part Number	Seal Type	Material
1.181	1.653	.354	15194 H1L7	P	NBR
1.181	1.771	.276	19431 2160	HP	EPDM
1.181	1.771	.276	19431 5066	HP	FKM
1.181	1.771	.393	17236 H1L5	LUP	NBR
1.181	1.771	.393	17236 H5L16	LUP	FKM
1.181	1.850	.394	15129 H1L5	LPD	NBR
1.181	1.850	.394	15129 H5L16	LPD	FKM
1.181	1.969	.394	15314 H1L5	RPD	NBR
1.181	2.000	.375	10682 H1L5	LPD	NBR
1.181	2.000	.375	10682 H5L16	LPD	FKM
1.181	2.047	.394	14888 H1L5	LPD	NBR
1.181	2.047	.394	15508 H1L5	LUP	NBR
1.181	2.047	.394	15508 H5L16	LUP	FKM
1.181	2.165	.250	19657 H1L5 PTFE	SS	N/P
1.181	2.165	.394	18374 H1L5	LUP	NBR
1.181	2.441	.250	6474 H1L7	SS	NBR
1.181	2.441	.250	6474 H1L7 PTFE	SS	N/P
1.181	2.441	.250	6474 H5L16	SS	FKM
1.181	2.442	.312	5204 H1L5	LUP	NBR
1.181	2.442	.312	5204 H1L5 PTFE	LUP	N/P
1.181	2.442	.312	5204 H5L16 PTFE	LUP	F/P
1.181	2.835	.375	16677 H1L5	SS	NBR
1.181	2.835	.375	16677 H1L7	SS	NBR
1.181	2.835	.375	16677 H5L16	SS	FKM
1.181	2.835	.438	18023 H1L5	LDS	NBR
1.182	1.563	.313	11450 ALLL7	P	NBR
1.182	1.875	.188	9497 414	DS	CR
1.187	1.750	.312	TMAL 1750-2018	TMAL	PTFE
1.187	1.752	.250	0502 LDN 283 01187 250 VN	LDN	PTFE
1.187	1.875	.375	TMAS 1875-2422	TMAS	PTFE
1.187	2.125	.375	16465 H1L5	LDS	NBR
1.187	2.125	.375	16465 H5L16	LDS	FKM
1.187	2.125	.437	18463 H1L5	LUP	NBR
1.187	2.125	.437	18463 H5L16	LUP	FKM
1.188	1.750	.250	TN 1750-1618	TN	N/P
1.188	1.750	.250	TNV 1750-1618	TN	N/P
1.188	1.563	.188	6157 H1L5	SS	NBR
1.188	1.563	.188	6157 H1L7	SS	NBR
1.188	1.563	.188	6157 H5L16	SS	FKM
1.188	1.625	.250	10102 H1L7	SS	NBR
1.188	1.687	.250	0502 LDN 250 01188 250 VN	LDN	PTFE
1.188	1.687	.250	1188-1687-250ETBN	TB	NBR
1.188	1.688	.312	0118 14627	SPLIT	NBR
1.188	1.750	.250	19746 H1L5 PTFE	SS	N/P
1.188	1.750	.375	18034 H1L5	LDS	NBR
1.188	1.752	.250	0502 LDN 282 01188 250 VN	LDN	PTFE
1.188	1.752	.250	1188-1752-250ETBN	TB	NBR
1.188	1.813	.313	0118 6008	SPLIT	NBR
1.188	1.813	.313	9730 H1L5	LUP	NBR
1.188	1.813	.313	9730 H1L5 PTFE	LUP	N/P
1.188	1.813	.313	9730 H5L16	LUP	FKM
1.188	1.828	.250	0502 LDN 320 01188 250 VN	LDN	PTFE
1.188	1.828	.375	1188-1828-375ETBN	TB	NBR
1.188	1.875	.250	0502 LDN 344 01188 250 VN	LDN	PTFE
1.188	1.875	.250	1188-1875-250ETBN	TB	NBR
1.188	1.875	.344	15483 5066	HP	FKM
1.188	1.875	.344	15483 5066 304	HP	FKM
1.188	1.875	.344	15483 5066 316	HP	FKM
1.188	1.875	.344	16504 5066	HP	FKM
1.188	1.875	.344	16504 5066 304	HP	FKM
1.188	1.875	.344	16504 5066 316	HP	FKM
1.188	1.875	.375	9511 H1L5	LPD	NBR
1.188	1.875	.375	9511 H1L5 PTFE	LPD	N/P
1.188	1.875	.375	9511 H5L16	LPD	FKM
1.188	1.938	.250	12887 H1L5	LDS	NBR
1.188	1.938	.250	5692 H1L5	RUP	NBR

Shaft Dia.	Bore Dia.	Seal Width	Parker Part Number	Seal Type	Material
1.188	1.938	.250	5692 H1L7	RUP	NBR
1.188	1.938	.250	5692 H5L16	RUP	FKM
1.188	1.938	.375	0118 4030	SPLIT	NBR
1.188	1.983	.250	0502 LDN 398 01188 250 VN	LDN	PTFE
1.188	1.983	.250	1188-1983-250ETBN	TB	NBR
1.188	2.000	.250	0502 LDN 406 01188 250 VN	LDN	PTFE
1.188	2.000	.250	1188-2000-250ETBN	TB	NBR
1.188	2.000	.375	0118 9659	SPLIT	NBR
1.188	2.000	.438	6162 H1L5	LUP	NBR
1.188	2.000	.438	6162 H1L5 PTFE	LUP	N/P
1.188	2.000	.438	6162 H5L16	LUP	FKM
1.188	2.062	.375	4996 H1L5	B	NBR
1.188	2.063	.375	6309 H1L5	SS	NBR
1.188	2.063	.375	6309 H1L7	SS	NBR
1.188	2.063	.500	10426 H1L21	LUP	EPDM
1.188	2.063	.500	10426 H1L5	LUP	NBR
1.188	2.063	.500	10426 H5L16	LUP	FKM
1.188	2.166	.250	6877 H1L5	LUP	NBR
1.188	2.166	.250	6877 H1L5 PTFE	LUP	N/P
1.188	2.166	.250	6877 H5L16	LUP	FKM
1.188	2.188	.438	0118 3108	SPLIT	NBR
1.188	2.188	.468	TMAL 2188-3032	TMAL	PTFE
1.188	2.188	.500	5407 H1L5	SS	NBR
1.188	2.188	.500	5407 H1L7	SS	NBR
1.188	2.250	.312	10500 H1L5	LUP	NBR
1.188	2.250	.312	10500 H5L16	LUP	FKM
1.188	2.250	.500	10569 H1L5	LUP	NBR
1.188	2.360	.250	7212 H1L5	LUP	NBR
1.188	2.375	.375	14248 H1L5	LPD	NBR
1.188	2.437	.250	0502 LDN 625 01188 250 VN	LDN	PTFE
1.188	2.437	.250	1188-2437-250ETBN	TB	NBR
1.188	2.438	.469	7011 H1L5	LUP	NBR
1.188	2.438	.469	7011 H5L16	LUP	FKM
1.188	2.441	.250	0502 LDN 627 01188 250 VN	LDN	PTFE
1.188	2.441	.380	1188-2441-380ETBN	TB	NBR
1.188	2.906	.429	15616 H1L5	SPCL	NBR
1.218	2.062	.500	TMAL 2062-3227	TMAL	PTFE
1.219	1.844	.313	0121 9827	SPLIT	NBR
1.219	1.906	.375	0121 3688	SPLIT	NBR
1.219	1.969	.375	0121 4030	SPLIT	NBR
1.219	1.979	.250	1219-1979-250EVBN	VB	NBR
1.219	1.979	.250	0502 LDN 380 01219 250 VN	LDN	PTFE
1.219	2.219	.438	0121 3108	SPLIT	NBR
1.241	2.835	.375	TMAL 2835-2451	TMAL	PTFE
1.249	2.191	.438	18411	RUP	NBR
1.250	1.500	.125	1250-1500-125EVBN	VB	NBR
1.250	1.563	.250	16969 H1L5 PTFE	SS	N/P
1.250	1.563	.250	16969 H3L8	SS	CR
1.250	1.566	.328	11711 ALLL7	P	NBR
1.250	1.625	.187	TN 1625-1212	TN	N/P
1.250	1.625	.187	TNV 1625-1212	TN	N/P
1.250	1.625	.188	12261 ALLL5	SS	NBR
1.250	1.625	.188	1250-1625-188ETBN	TB	NBR
1.250	1.625	.250	19320 5066	HP	FKM
1.250	1.625	.250	6050 414	DS	CR
1.250	1.686	.188	1250-1686-188EVBN	VB	NBR
1.250	1.686	.375	10107	SS	NBR
1.250	1.687	.250	1250-1687-250ETBN	TB	NBR
1.250	1.688	.250	10893 H1L7	H	NBR
1.250	1.688	.250	11583 H1L7	SS	NBR
1.250	1.688	.250	11583 H3L8	SS	CR
1.250	1.688	.375	10877 H1L7	SS	NBR
1.250	1.688	.438	9773 H1L5	SDS	NBR
1.250	1.688	.438	9773 H1L7	SDS	NBR
1.250	1.750	.250	0502 LDN 250 01250 250 VN	LDN	PTFE
1.250	1.750	.250	8820 H1L5	LUP	NBR

See Section 4 for seal type description. For High Misalignment sizes, see Page B-86.
For FlexiSeal Listings, see Pages B-93 and B-97.

03/03/06



Rotary Lip Seal Inch Sizes

1.250 to 1.250

B

Shaft Dia.	Bore Dia.	Seal Width	Parker Part Number	Seal Type	Material
1.250	1.750	.250	8820 H1L5 PTFE	LUP	N/P
1.250	1.750	.250	8820 H1L2160	LUP	EPDM
1.250	1.750	.250	8820 H1L20 PTFE	LUP	XNBR
1.250	1.750	.250	8820 H5L16	LUP	FKM
1.250	1.750	.250	8820 H5L16 PTFE	LUP	F/P
1.250	1.750	.250	10833 H1L5 PTFE	SS	N/P
1.250	1.750	.250	10833 H1L7	SS	NBR
1.250	1.750	.250	10833 H1L7 PTFE	SS	N/P
1.250	1.750	.250	10833 H5L16	SS	FKM
1.250	1.750	.250	19783 H1L5 PTFE	SS	N/P
1.250	1.750	.250	TMAL 1750-1616	TMAL	PTFE
1.250	1.750	.250	TN 1750-1616	TN	N/P
1.250	1.750	.312	5389 H1L5	LUP	NBR
1.250	1.750	.312	5389 H1L5 PTFE	LUP	N/P
1.250	1.750	.312	5389 H5L16	LUP	FKM
1.250	1.750	.312	14627 H1L5	RPD	NBR
1.250	1.752	.250	0502 LDN 251 01250 250 VN	LDN	PTFE
1.250	1.752	.250	1250-1752-250ETBN	TB	NBR
1.250	1.850	.500	15949 H1L5	LUPW	NBR
1.250	1.857	.375	15036 H1L5	LUP	NBR
1.250	1.874	.250	0502 LDN 312 01250 250 VN	LDN	PTFE
1.250	1.874	.250	1250-1874-250ETBN	TB	NBR
1.250	1.875	.250	19938 H1L5	RUP	NBR
1.250	1.875	.250	19938 H1L5 PTFE	RUP	N/P
1.250	1.875	.313	16197 H1L7	H	NBR
1.250	1.875	.313	6008 H1L5	RPD	NBR
1.250	1.875	.313	0125 9827	SPLIT	NBR
1.250	1.875	.313	10608 H1L20	SS	XNBR
1.250	1.875	.313	10608 H1L7	SS	NBR
1.250	1.875	.313	10608 H1L7 PTFE	SS	N/P
1.250	1.875	.375	9273 H1L5	LPD	NBR
1.250	1.875	.375	9273 H1L2160	LPD	EPDM
1.250	1.875	.375	9273 H5L16	LPD	FKM
1.250	1.875	.375	12702 H1L7	P	NBR
1.250	1.875	.375	12702 H1L7 PTFE	P	N/P
1.250	1.875	.375	12702 H5L16	P	FKM
1.250	1.875	.375	TMAL 1875-2420	TMAL	PTFE
1.250	1.885	.375	19994 5066 PTFE	HP	F/P
1.250	1.937	.375	0125 3688	SPLIT	NBR
1.250	1.979	.250	0502 LDN 365 01250 250 VN	LDN	PTFE
1.250	1.979	.250	1250-1979-250ETBN	TB	NBR
1.250	1.983	.250	0502 LDN 367 01250 250 VN	LDN	PTFE
1.250	1.983	.250	1250-1983-250ETBN	TB	NBR
1.250	1.984	.375	9028 H1L5	LUP	NBR
1.250	1.984	.375	9028 H5L16	LUP	FKM
1.250	2.000	.250	0502 LDN 375 01250 250 VN	LDN	PTFE
1.250	2.000	.250	19452 H1L5	LUP	NBR
1.250	2.000	.250	19452 H5L89	LUP	FKM
1.250	2.000	.250	20403 H5L16 PTFE	LUP	F/P
1.250	2.000	.250	1250-2000-250ETBN	TB	NBR
1.250	2.000	.250	1250-2000-250EVBN	VB	NBR
1.250	2.000	.313	10525 H1L7	SS	NBR
1.250	2.000	.313	10525 H5L16	SS	FKM
1.250	2.000	.375	15786 5066	HP	FKM
1.250	2.000	.375	15786 5066 304	HP	FKM
1.250	2.000	.375	15786 5066 316	HP	FKM
1.250	2.000	.375	15786 5066 EPDM	HP	EPDM
1.250	2.000	.375	15786 5066 GLUE	HP	FKM
1.250	2.000	.375	15786 5066 PTFE	HP	F/P
1.250	2.000	.375	10058 H1L5	LUP	NBR
1.250	2.000	.375	10058 H1L5 PTFE	LUP	N/P
1.250	2.000	.375	10058 H5L16	LUP	FKM
1.250	2.000	.375	10058 H5MX5489	LUP	FKM
1.250	2.000	.375	4423 H1L5	RUP	NBR
1.250	2.000	.375	4423 H5L16	RUP	FKM
1.250	2.000	.375	0125 4030	SPLIT	NBR

Shaft Dia.	Bore Dia.	Seal Width	Parker Part Number	Seal Type	Material
1.250	2.000	.438	5026 H1L5	LA	NBR
1.250	2.000	.500	5727 H1L5	LA	NBR
1.250	2.000	.500	14904 H1L21	LDS	EPDM
1.250	2.000	.500	14904 H1L5	LDS	NBR
1.250	2.047	.276	19432 5066	HP	FKM
1.250	2.047	.375	17053 H1L5	SS	NBR
1.250	2.047	.375	17053 H5L16	SS	FKM
1.250	2.062	.250	0502 LDN 406 01250 250 VN	LDN	PTFE
1.250	2.062	.250	1250-2062-250ETBN	TB	NBR
1.250	2.062	.250	1250-2062-250EVBN	VB	NBR
1.250	2.062	.375	9659 H1L5	RUP	NBR
1.250	2.062	.375	9659 H5L16	RUP	FKM
1.250	2.062	.437	5728 H1L5	LUP	NBR
1.250	2.062	.437	5728 H5L16	LUP	FKM
1.250	2.063	.375	9659 H1L7	RPD	NBR
1.250	2.063	.438	14799 H1L5	LPDW	NBR
1.250	2.106	.438	9180 H1L5	LPD	NBR
1.250	2.125	.250	0502 LDN 438 01250 250 VN	LDN	PTFE
1.250	2.125	.250	1250-2125-250ETBN	TB	NBR
1.250	2.125	.250	1250-2125-250EVBN	VB	NBR
1.250	2.125	.375	16516 H1L5	LDS	NBR
1.250	2.125	.375	16516 H5L16	LDS	FKM
1.250	2.125	.375	9423 H1L5	LPD	NBR
1.250	2.125	.375	9423 H1L5 PTFE	LPD	N/P
1.250	2.125	.375	19653 H1L20	SS	XNBR
1.250	2.125	.438	11193 H1L5	LPD	NBR
1.250	2.125	.438	11193 H5L16	LPD	FKM
1.250	2.125	.438	0125 3691	SPLIT	NBR
1.250	2.193	.500	0125 8381	SPLIT	NBR
1.250	2.250	.093	18980 ALL5	SPCL	NBR
1.250	2.250	.093	18980 H1L5	SPCL	NBR
1.250	2.250	.250	0502 LDN 500 01250 250 VN	LDN	PTFE
1.250	2.250	.250	1250-2250-250ETBN	TB	NBR
1.250	2.250	.250	1250-2250-250EVBN	VB	NBR
1.250	2.250	.375	10053 H1L2160	LPD	EPDM
1.250	2.250	.375	10053 H1L5	LPD	NBR
1.250	2.250	.375	10053 H1L5 PTFE	LPD	N/P
1.250	2.250	.375	10053 H1L70	LPD	H1L70
1.250	2.250	.375	10053 H5L16	LPD	FKM
1.250	2.250	.438	0125 10477	SPLIT	NBR
1.250	2.250	.438	0125 10477 L50	SPLIT	NBR
1.250	2.250	.500	13578 H1L5	LDS	NBR
1.250	2.250	.500	13578 H5L16	LDS	FKM
1.250	2.250	.500	5729 H1L5	LUP	NBR
1.250	2.250	.500	5729 H5L16	LUP	FKM
1.250	2.250	.500	17648 H1L5	RUP	NBR
1.250	2.374	.250	0502 LDN 562 01250 250 VN	LDN	PTFE
1.250	2.374	.313	1250-2374-313ETBN	TB	NBR
1.250	2.437	.250	0502 LDN 594 01250 250 VN	LDN	PTFE
1.250	2.437	.313	1250-2437-313ETBN	TB	NBR
1.250	2.438	.438	11982 H1L5	LUP	NBR
1.250	2.438	.438	11982 H1L5 PTFE	LUP	N/P
1.250	2.438	.438	11982 H5L16	LUP	FKM
1.250	2.441	.313	0502 LDN 596 01250 313 VN	LDN	PTFE
1.250	2.441	.375	1250-2441-375ETBN	TB	NBR
1.250	2.500	.250	5164 H1L7	SS	NBR
1.250	2.500	.500	40032 H1L5	LDS	NBR
1.250	2.500	.500	40032 H5MX5489	LDS	FKM
1.250	2.500	.500	8924 H1L5	LPD	NBR
1.250	2.502	.313	0502 LDN 626 01250 313 VN	LDN	PTFE
1.250	2.502	.313	1250-2502-313ETBN	TB	NBR
1.250	2.835	.313	0502 LDN 793 01250 313 VN	LDN	PTFE
1.250	2.835	.375	1250-2835-375ETBN	TB	NBR
1.250	2.835	.375	6328 H1L7	SS	NBR
1.250	3.020	.442	18787 ALL5	SPC	NBR
1.250	3.063	.375	14591 H1L5	LDS	NBR

See Section 4 for seal type description. For High Misalignment sizes, see Page B-86. For FlexiSeal Listings, see Pages B-93 and B-97.

03/03/06





Shaft Dia.	Bore Dia.	Seal Width	Parker Part Number	Seal Type	Material
1.250	3.151	.375	12278 H1L5	LPD	NBR
1.250	3.499	.500	12954 H1L5	SSW	NBR
1.250	3.499	.500	12954 H1L7	SSW	NBR
1.250	3.499	.500	12954 H5MX5489	SSW	FKM
1.250	3.551	.438	0125 12352	SPLIT	NBR
1.256	1.850	.312	TMAS 1850-2019	TMAS	PTFE
1.260	1.732	.354	15859	P	NBR
1.260	1.850	.394	15054 H1L5	LPD	NBR
1.260	1.891	.315	13301 H1L7	H	NBR
1.260	1.891	.354	13300	P	NBR
1.260	2.205	.394	17278 H1L5	LUP	NBR
1.264	1.983	.375	TMAL 1983-2423	TMAL	PTFE
1.274	1.850	.156	11347 H1L7	SS	NBR
1.274	1.850	.160	70000 H1L5	TSS	NBR
1.280	1.687	.421	TMAL 1687-2713	TMAL	PTFE
1.282	1.906	.313	0128 9827	SPLIT	NBR
1.282	2.032	.375	0128 3815	SPLIT	NBR
1.282	2.224	.500	0128 8381	SPLIT	NBR
1.282	2.282	.438	0128 10477	SPLIT	NBR
1.282	3.582	.438	0128 12352	SPLIT	NBR
1.299	1.969	.315	15491 H1L5	LPD	NBR
1.300	1.875	.250	15708 H1L7	H	NBR
1.300	2.074	.300	13248 ALLL5	LPDW	NBR
1.309	1.875	.438	5927	SS	NBR
1.312	2.062	.375	14341 H1L5	LPD	NBR
1.312	2.062	.375	14341 H5L16	LPD	FKM
1.312	2.125	.375	12830 H1L5	LPD	NBR
1.312	2.125	.375	12830 H5L16	LPD	FKM
1.312	2.250	.500	TMAL 2250-3230	TMAL	PTFE
1.313	1.750	.250	16305 H1L7	SS	NBR
1.313	1.750	.250	16305 H1L7 PTFE	SS	N/P
1.313	1.813	.250	9639 H1L5	LUP	NBR
1.313	1.813	.250	9639 H5L16	LUP	FKM
1.313	1.813	.313	0131 5866	SPLIT	NBR
1.313	1.828	.437	17686 H1L20	LDS	XNBR
1.313	1.828	.437	17686 H1L5	LDS	NBR
1.313	1.937	.313	0131 9827	SPLIT	NBR
1.313	1.938	.313	0131 4450	SPLIT	NBR
1.313	1.984	.375	12210 H1L5	LPD	NBR
1.313	1.984	.375	12210 H5L16	LPD	FKM
1.313	2.000	.437	0131 4186	SPLIT	NBR
1.313	2.062	.313	0502 LDN 375 01313 313 VN	LDN	PTFE
1.313	2.062	.313	1313-2062-313ETBN	TB	NBR
1.313	2.063	.375	17529	LUP	NBR
1.313	2.063	.375	0131 3815	SPLIT	NBR
1.313	2.063	.438	4287 H1L5	RUP	NBR
1.313	2.125	.312	1313-2125-312ETBN	TB	NBR
1.313	2.125	.313	0502 LDN 406 01313 313 VN	LDN	PTFE
1.313	2.125	.313	1313-2125-313ETBN	TB	NBR
1.313	2.125	.438	3966 H1L5	RPD	NBR
1.313	2.125	.500	0131 4281	SPLIT	NBR
1.313	2.188	.438	0131 3691	SPLIT	NBR
1.313	2.250	.313	0502 LDN 469 01313 313 VN	LDN	PTFE
1.313	2.250	.313	1313-2250-313ETBN	TB	NBR
1.313	2.255	.500	0131 8381	SPLIT	NBR
1.313	2.282	.469	7109 H1L5	LA	NBR
1.313	2.313	.438	0131 10477	SPLIT	NBR
1.313	2.375	.313	18853 5066	HP	FKM
1.313	2.375	.313	18853 5066 304	HP	FKM
1.313	2.375	.500	14412 H1L5	LDS	NBR
1.313	2.375	.500	14412 H5L16	LDS	FKM
1.313	2.375	.500	6134 H1L5	LPD	NBR
1.313	2.375	.500	6134 H5L16	LPD	FKM
1.313	2.500	.375	0131 11808	SPLIT	NBR
1.313	2.500	.375	9630 H1L5	LPD	NBR
1.313	2.875	.500	15168 H1L5	LPD	NBR

Shaft Dia.	Bore Dia.	Seal Width	Parker Part Number	Seal Type	Material
1.313	3.613	.438	0131 12352	SPLIT	NBR
1.339	2.047	.256	20765 H5L16	RUP	FKM
1.344	1.844	.313	0134 5866	SPLIT	NBR
1.344	1.969	.313	0134 4450	SPLIT	NBR
1.344	2.032	.437	0134 4186	SPLIT	NBR
1.344	2.094	.375	0134 3815	SPLIT	NBR
1.344	2.157	.500	0134 4281	SPLIT	NBR
1.344	2.219	.438	0134 3691	SPLIT	NBR
1.344	2.250	.500	0134 11365	SPLIT	NBR
1.344	2.281	.469	10865 H1L5	LPD	NBR
1.344	2.286	.500	0134 8381	SPLIT	NBR
1.344	2.344	.438	0134 10477	SPLIT	NBR
1.344	2.532	.375	0134 11808	SPLIT	NBR
1.350	1.830	.313	6668 H1L5	LA	NBR
1.356	1.825	.250	TMAL 1825-1615	TMAL	PTFE
1.359	1.828	.250	TMAL 1828-1615	TMAL	PTFE
1.362	2.242	.250	11053 H1L5	LPD	NBR
1.362	2.242	.250	11053 H5L16	LPD	FKM
1.365	2.081	.313	0502 LDN 358 01365 313 VN	LDN	PTFE
1.365	2.081	.313	1365-2081-313ETBN	TB	NBR
1.370	2.375	.312	19667 H1L5	LUP	NBR
1.370	2.378	.312	19748 H1L5	LUP	NBR
1.375	1.691	.281	12315 ALLL7	P	NBR
1.375	1.750	.188	1375-1750-188EVBN	VB	NBR
1.375	1.750	.250	1375-1750-250ETBN	TB	NBR
1.375	1.828	.188	6369 H1L5 PTFE	SS	N/P
1.375	1.828	.188	6369 H1L7	SS	NBR
1.375	1.828	.188	6369 H3L8	SS	CR
1.375	1.828	.250	20563 5066	HP	FKM
1.375	1.828	.313	1375-1828-313ETBN	TB	NBR
1.375	1.874	.313	0502 LDN 250 01375 313 VN	LDN	PTFE
1.375	1.874	.250	1375-1874-250ETBN	TB	NBR
1.375	1.875	.250	9080 H1L5	LUP	NBR
1.375	1.875	.250	9080 H1L5 PTFE	LUP	N/P
1.375	1.875	.250	9080 H1MX9580	LUP	HNBR
1.375	1.875	.250	9080 H5L16	LUP	FKM
1.375	1.875	.250	9080 H5L16 PTFE	LUP	F/P
1.375	1.875	.250	NSEC81039	SEC	NBR
1.375	1.875	.250	TMAS 1875-1616	TMAS	PTFE
1.375	1.875	.250	TN 1875-1616	TN	N/P
1.375	1.875	.312	10855 H1L5	LPD	NBR
1.375	1.875	.312	10855 H5L16	LPD	FKM
1.375	1.875	.313	0137 5866	SPLIT	NBR
1.375	1.875	.335	60004 H1L5	LDS	NBR
1.375	1.875	.335	60004 ALLL16	LDS	FKM
1.375	1.900	.250	20770 ALLL16	MP	FKM
1.375	1.938	.313	0502 LDN 282 01375 313 VN	LDN	PTFE
1.375	1.938	.250	1375-1938-250ETBN	TB	NBR
1.375	1.938	.250	1375-1938-250EVBN	VB	NBR
1.375	2.000	.250	1375-2000-250ETBN	TB	NBR
1.375	2.000	.250	TN 2000-1620	TN	N/P
1.375	2.000	.250	TNV 2000-1620	TN	N/P
1.375	2.000	.250	1375-2000-250EVBN	VB	NBR
1.375	2.000	.313	0502 LDN 313 01375 313 VN	LDN	PTFE
1.375	2.000	.313	15883 5066	HP	FKM
1.375	2.000	.313	15883 5066 304	HP	FKM
1.375	2.000	.313	15883 5066 316	HP	FKM
1.375	2.000	.313	0502 LDN 313 01375 313 VN	LDN	PTFE
1.375	2.000	.313	10485 H1L5	LUP	NBR
1.375	2.000	.313	10485 H1L5 PTFE	LUP	N/P
1.375	2.000	.313	10485 H5L16	LUP	FKM
1.375	2.000	.313	10485 H5L16 PTF	LUP	F/P
1.375	2.000	.313	19217	MP	FKM
1.375	2.000	.313	0137 4450	SPLIT	NBR
1.375	2.000	.313	0137 4450 V	SPLIT	FKM
1.375	2.000	.313	5271 H1L5 PTFE	SS	N/P

See Section 4 for seal type description. For High Misalignment sizes, see Page B-86. For FlexiSeal Listings, see Pages B-93 and B-97.

03/03/06



Rotary Lip Seal Inch Sizes

1.375 to 1.375

B

Shaft Dia.	Bore Dia.	Seal Width	Parker Part Number	Seal Type	Material
1.375	2.000	.313	5271 H1L7	SS	NBR
1.375	2.000	.313	1375-2000-313ETBN	TB	NBR
1.375	2.000	.313	TMAL 2000-2020	TMAL	PTFE
1.375	2.000	.375	5804 H1L7	SS	NBR
1.375	2.000	.438	17692 H1L5	LDS	NBR
1.375	2.000	.438	17692 H5L16	LDS	FKM
1.375	2.004	.313	0137 9827	SPLIT	NBR
1.375	2.047	.438	9755 H1L5	LUP	NBR
1.375	2.047	.438	9755 H5L16	LUP	FKM
1.375	2.062	.250	6528 H1L5	LA	NBR
1.375	2.062	.250	6528 H5L16	LA	FKM
1.375	2.062	.313	0502 LDN 344 01375 313 VN	LDN	PTFE
1.375	2.062	.250	1375-2062-250ETBN	TB	NBR
1.375	2.062	.375	19687 H1L70	LDS	NBR
1.375	2.062	.375	10753 H1L5	LUP	NBR
1.375	2.062	.375	10753 H5L16	LUP	FKM
1.375	2.062	.375	3688 H1L5	RPD	NBR
1.375	2.062	.375	3688 H5L16	RPD	FKM
1.375	2.062	.438	14854 H1L5	LPD	NBR
1.375	2.063	.437	0137 4186	SPLIT	NBR
1.375	2.106	.469	5983 H1L5	LA	NBR
1.375	2.106	.469	5983 H5MX5489	LA	FKM
1.375	2.125	.313	0502 LDN 375 01375 313 VN	LDN	PTFE
1.375	2.125	.250	6506 H1L7	SS	NBR
1.375	2.125	.250	1375-2125-250ETBN	TB	NBR
1.375	2.125	.313	0502 LDN 375 01375 313 VN	LDN	PTFE
1.375	2.125	.313	1375-2125-313ETBN	TB	NBR
1.375	2.125	.335	17897 5066	HP	FKM
1.375	2.125	.335	17897 5066 304	HP	FKM
1.375	2.125	.335	17897 5066 316	HP	FKM
1.375	2.125	.375	16207 H1L7	H	NBR
1.375	2.125	.375	15058 5066	HP	FKM
1.375	2.125	.375	15058 5066 304	HP	FKM
1.375	2.125	.375	15058 5066 316	HP	FKM
1.375	2.125	.375	15481 5066	HP	FKM
1.375	2.125	.375	15481 5066 304	HP	FKM
1.375	2.125	.375	15481 5066 316	HP	FKM
1.375	2.125	.375	19661 H1L5 HP	SPC	NBR
1.375	2.125	.375	8831 H1L5	LPD	NBR
1.375	2.125	.375	8831 H1L5 PTFE	LPD	N/P
1.375	2.125	.375	8831 H1L7	LPD	NBR
1.375	2.125	.375	8831 H5L16	LPD	FKM
1.375	2.125	.375	19383 5201	MP	FKM
1.375	2.125	.375	4030 H1L5	RPD	NBR
1.375	2.125	.375	4030 H5L16	RPD	FKM
1.375	2.125	.375	0137 3815	SPLIT	NBR
1.375	2.125	.375	0137 8899	SPLIT	NBR
1.375	2.125	.375	5830 H1L5	SS	NBR
1.375	2.125	.375	TMAL 2125-2424	TMAL	PTFE
1.375	2.125	.437	15099 H1L5	LUP	NBR
1.375	2.125	.437	15099 H1L70	LUP	NBR
1.375	2.125	.437	15099 H5L16	LUP	FKM
1.375	2.250	.250	1375-2250-250EVBN	VB	NBR
1.375	2.250	.290	16950 H1L5	SSW	NBR
1.375	2.250	.312	1375-2250-312ETBN	TB	NBR
1.375	2.250	.313	0502 LDN 438 01375 313 VN	LDN	PTFE
1.375	2.250	.375	10404 H1L5	LUP	NBR
1.375	2.250	.375	10404 H1L5 PTFE	LUP	N/P
1.375	2.250	.375	10404 H5L16	LUP	FKM
1.375	2.250	.375	16435 H1L5	LUPW	NBR
1.375	2.250	.375	5153 H1L5 PTFE	SS	N/P
1.375	2.250	.375	5153 H1L7	SS	NBR
1.375	2.250	.438	0137 3691	SPLIT	NBR
1.375	2.250	.500	16466 5066	LDS	FKM
1.375	2.250	.500	16466 H1L5	LDS	NBR
1.375	2.250	.500	16466 H5L16	LDS	FKM

Shaft Dia.	Bore Dia.	Seal Width	Parker Part Number	Seal Type	Material
1.375	2.250	.500	40000 H1L5	LDS	NBR
1.375	2.250	.500	40000 H5L16	LDS	FKM
1.375	2.250	.500	60013 H1L5	LDS	NBR
1.375	2.250	.500	3740 H1L5	LPD	NBR
1.375	2.250	.500	3740 H5L16	LPD	FKM
1.375	2.250	.500	18791 H1L5	LUP	NBR
1.375	2.250	.500	18791 H5L16	LUP	FKM
1.375	2.250	.500	5730 H1L5	LUP	NBR
1.375	2.374	.312	1375-2374-312ETBN	TB	NBR
1.375	2.374	.313	0502 LDN 500 01375 313 VN	LDN	PTFE
1.375	2.374	.500	20449 H1L5	OLLUP	NBR
1.375	2.375	.437	19672 H1L5	LUP	NBR
1.375	2.375	.437	19672 H5L16	LUP	FKM
1.375	2.375	.438	0137 10477	SPLIT	NBR
1.375	2.375	.500	16520 5066	HP	FKM
1.375	2.375	.500	16520 5066 304	HP	FKM
1.375	2.375	.500	16520 5066 316	HP	FKM
1.375	2.375	.500	16520 5066304PT	HP	F/P
1.375	2.375	.500	18150 5066	HP	FKM
1.375	2.375	.500	18150 5066 304	HP	FKM
1.375	2.375	.500	18150 5066 316	HP	FKM
1.375	2.375	.500	5644 H1L5	LUP	NBR
1.375	2.375	.500	5644 H1L5 PTFE	LUP	N/P
1.375	2.375	.500	5644 H1L70	LUP	NBR
1.375	2.375	.500	5644 H5L16	LUP	FKM
1.375	2.406	.531	17084 H1L5	LUP	NBR
1.375	2.435	.297	8449 H1L7	SS	NBR
1.375	2.437	.250	1375-2437-250ETBN	TB	NBR
1.375	2.437	.313	0502 LDN 531 01375 313 VN	LDN	PTFE
1.375	2.438	.250	20850 H5L89	LUP	FKM
1.375	2.438	.375	5731 H1L5	LPD	NBR
1.375	2.438	.375	5731 H5L16	LPD	FKM
1.375	2.438	.438	10524 H1L5	LPD	NBR
1.375	2.441	.313	0502 LDN 533 01375 313 VN	LDN	PTFE
1.375	2.441	.313	1375-2441-313ETBN	TB	NBR
1.375	2.441	.375	40045 H5L16	LDS	FKM
1.375	2.443	.297	9733 H1L5	LPD	NBR
1.375	2.443	.297	9733 H5L16	LPD	FKM
1.375	2.443	.375	14833 H1L5	LPDW	NBR
1.375	2.443	.375	14833 H5L16	LPDW	FKM
1.375	2.500	.188	9498 414	DS	CR
1.375	2.500	.313	0502 LDN 563 01375 313 VN	LDN	PTFE
1.375	2.500	.375	9394 H1L5	LUP	NBR
1.375	2.500	.375	9394 H5L16	LUP	FKM
1.375	2.500	.375	0137 6848	SPLIT	NBR
1.375	2.500	.375	16439 446	SSW	FAB
1.375	2.500	.375	16439 H1L5	SSW	NBR
1.375	2.500	.375	TMAL 2500-2436	TMAL	PTFE
1.375	2.502	.313	0502 LDN 564 01375 313 VN	LDN	PTFE
1.375	2.502	.313	1375-2502-313ETBN	TB	NBR
1.375	2.562	.313	0502 LDN 594 01375 313 VN	LDN	PTFE
1.375	2.562	.375	12939 H1L5	OLSS	NBR
1.375	2.563	.375	1375-2562-375ETBN	TB	NBR
1.375	2.623	.313	0502 LDN 624 01375 313 VN	LDN	PTFE
1.375	2.623	.313	1375-2623-313ETBN	TB	NBR
1.375	2.625	.375	13758 H1L5	LUP	NBR
1.375	2.688	.500	6786 H1L5	LA	NBR
1.375	2.834	.250	17653 H1L5	LUP	NBR
1.375	2.834	.250	17653 H1L5 PTFE	LUP	N/P
1.375	2.834	.250	17653 H5L16	LUP	FKM
1.375	2.835	.313	0502 LDN 730 01375 313 VN	LDN	PTFE
1.375	2.835	.313	1375-2835-313ETBN	TB	NBR
1.375	3.125	.500	18799 H1L5	LUP	NBR
1.375	3.125	.500	18799 H5L16	LUP	FKM
1.375	3.150	.313	12020 H1L5	LUP	NBR
1.375	3.150	.313	12020 H1L5 PTFE	LUP	N/P

See Section 4 for seal type description. For High Misalignment sizes, see Page B-86. For FlexiSeal Listings, see Pages B-93 and B-97.

03/03/06





Shaft Dia.	Bore Dia.	Seal Width	Parker Part Number	Seal Type	Material
1.375	3.500	.375	16593 H1L5	SSW	NBR
1.375	3.625	.500	20414 H1L5	LUP	NBR
1.375	3.675	.438	0137 12352	SPLIT	NBR
1.376	2.835	.375	13287 H1L5	LDS	NBR
1.376	2.835	.375	13287 H5L16	LDS	FKM
1.378	1.850	.236	17882 H1L7	H	NBR
1.378	2.008	.354	13999 H1L7	P	NBR
1.378	2.016	.188	11618 414	DS	CR
1.378	2.105	.469	11568 H1L5	LPD	NBR
1.378	2.105	.469	11568 H5L16	LPD	FKM
1.378	2.205	.394	11751 H1L5	LPD	NBR
1.378	2.205	.394	11751 H5L16	LPD	FKM
1.385	3.063	.375	14588 H1L5	LDS	NBR
1.391	2.000	.219	18813 H5L16	SS	FKM
1.400	2.631	.375	6322 H1L5	B	NBR
1.406	2.060	.300	19373 H1L5	P	NBR
1.406	2.308	.500	0140 11365	SPLIT	NBR
1.410	2.047	.433	14351 H5MX5489	P	FKM
1.420	2.130	.187	19740 H1L5	SS	NBR
1.430	2.253	.750	10350 ALLL7	LUP	NBR
1.430	2.954	.437	19671 H1L5	LUP	NBR
1.437	2.125	.375	TMAL 2125-2422	TMAL	PTFE
1.437	2.250	.375	TMAL 2250-2426	TMAL	PTFE
1.437	2.750	.312	19723 H1L5	LUP	NBR
1.437	3.150	.250	60012 H5L16	LDS	FKM
1.438	1.875	.187	TNV 1875-1214	TN	N/P
1.438	1.750	.281	18552 ALLL7	P	NBR
1.438	1.932	.313	0143 5866	SPLIT	NBR
1.438	2.000	.281	15405 5066	HP	FKM
1.438	2.000	.281	15405 5066 304	HP	FKM
1.438	2.000	.281	15405 5066 316	HP	FKM
1.438	2.000	.281	17177 5066	HP	FKM
1.438	2.000	.281	17177 5066 304	HP	FKM
1.438	2.000	.281	17177 5066 316	HP	FKM
1.438	2.000	.281	18233	P	NBR
1.438	2.000	.313	16456 H1L5	LUP	NBR
1.438	2.000	.313	16456 H5L16	LUP	FKM
1.438	2.000	.313	5683 H1L3	LUP	CR
1.438	2.000	.313	5683 H1L5	LUP	NBR
1.438	2.000	.313	5683 H5L16	LUP	FKM
1.438	2.000	.313	5659 H1L7	SS	NBR
1.438	2.000	.325	18233 H1L7	P	NBR
1.438	2.062	.313	0143 4450	SPLIT	NBR
1.438	2.063	.313	19084 H1L5	LDS	NBR
1.438	2.063	.313	9181 H1L5	LUP	NBR
1.438	2.063	.313	9827 H1L5	RPD	NBR
1.438	2.063	.313	9827 H5L16	RPD	FKM
1.438	2.083	.150	16695	SS	NBR
1.438	2.125	.313	0502 LDN 344 01438 313 VN	LDN	PTFE
1.438	2.125	.313	1438-2125-313ETBN	TB	NBR
1.438	2.125	.375	7047 H1L5	LA	NBR
1.438	2.125	.375	7047 H5L89	LA	FKM
1.438	2.125	.437	0143 4186	SPLIT	NBR
1.438	2.125	.438	7216 H1L5	LUP	NBR
1.438	2.125	.438	12894 H1L7	SS	NBR
1.438	2.188	.375	18444 H1L5	LUP	NBR
1.438	2.188	.375	0143 8899	SPLIT	NBR
1.438	2.188	.375	0143 8899 V	SPLIT	FKM
1.438	2.250	.375	13554 H1L5	LUP	NBR
1.438	2.250	.375	13554 H1L5 PTFE	LUP	N/P
1.438	2.250	.375	13554 H5L16	LUP	FKM
1.438	2.250	.375	16614 H1L5	SSW	NBR
1.438	2.250	.500	4850 H1L5	LPD	NBR
1.438	2.250	.500	0143 4281	SPLIT	NBR
1.438	2.313	.438	0143 3691	SPLIT	NBR
1.438	2.318	.375	0143 7182	SPLIT	NBR

Shaft Dia.	Bore Dia.	Seal Width	Parker Part Number	Seal Type	Material
1.438	2.374	.313	0502 LDN 468 01438 313 VN	LDN	PTFE
1.438	2.374	.313	1438-2374-313ETBN	TB	NBR
1.438	2.375	.375	4050 H1L21	LPD	EPDM
1.438	2.375	.375	4050 H1L5	LPD	NBR
1.438	2.375	.375	4050 H5L16	LPD	FKM
1.438	2.375	.406	16759 5066	HP	FKM
1.438	2.375	.406	16759 5066 304	HP	FKM
1.438	2.375	.406	16759 5066 316	HP	FKM
1.438	2.375	.500	9454 H1L5	LPD	NBR
1.438	2.375	.500	9454 H5L16	LPD	FKM
1.438	2.376	.500	0143 19067	SPLIT	NBR
1.438	2.438	.313	0502 LDN 500 01438 313 VN	LDN	PTFE
1.438	2.438	.313	1438-2437-313ETBN	TB	NBR
1.438	2.438	.438	3108 H1L5	RPD	NBR
1.438	2.438	.438	0143 4399	SPLIT	NBR
1.438	2.438	.500	7346 H1L5	LPD	NBR
1.438	2.500	.313	0502 LDN 531 01438 313 VN	LDN	PTFE
1.438	2.500	.313	1438-2500-313ETBN	TB	NBR
1.438	2.500	.500	5732 H1L5	LUP	NBR
1.438	2.500	.500	5732 H5L16	LUP	FKM
1.438	2.502	.500	17756 H1L5	LDS	NBR
1.438	2.502	.500	17756 H5L16	LDS	FKM
1.438	2.563	.375	0143 6848	SPLIT	NBR
1.438	2.625	.375	0143 11808	SPLIT	NBR
1.438	2.688	.375	10111 H1L3	LPD	CR
1.438	2.688	.375	10111 H1L5	LPD	NBR
1.438	2.688	.375	10111 H5MX5489	LPD	FKM
1.438	2.688	.375	TMAL 2688-2440	TMAL	PTFE
1.438	2.688	.375	TMAS 2688-2440	TMAS	PTFE
1.438	3.150	.250	60012 H1L5	LDS	NBR
1.441	2.254	.312	TMAL 2254-2026	TMAL	PTFE
1.449	2.063	.250	19177 H1L5	LUP	NBR
1.449	2.063	.250	19177 H5L16	LUP	FKM
1.460	3.150	.375	20438 H1L5	LUP	NBR
1.469	2.250	.375	10055 H1L5	LPD	NBR
1.469	2.250	.375	10055 H5L16	LPD	FKM
1.469	2.441	.500	4193 H1L5	LUP	NBR
1.469	2.750	.438	11783 H1L5	LDS	NBR
1.469	2.875	.375	11809 H1L5	LUP	NBR
1.469	2.875	.375	11809 H5MX5489	LUP	FKM
1.496	2.255	.315	19033	MP	FKM
1.496	2.441	.394	15263 H1L5	LPD	NBR
1.497	2.835	.500	11603 H1L5	LA	NBR
1.497	2.835	.500	11603 H1L7	LA	NBR
1.497	2.835	.500	6062 H1L5	LPD	NBR
1.497	2.835	.500	6062 H1L5 PTFE	LPD	N/P
1.498	2.062	.250	9643 H1L5	LPD	NBR
1.499	2.062	.312	TMAL 2062-2018	TMAL	PTFE
1.499	2.063	.250	11427 H1L5	LUP	NBR
1.499	2.063	.250	11427 H1L5 PTFE	LUP	N/P
1.499	2.063	.250	11427 H5L16	LUP	FKM
1.499	2.063	.250	11427 H5L16PTFE	LUP	F/P
1.499	2.312	.375	TMAL 2312-2426	TMAL	PTFE
1.500	1.816	.281	12316 ALLL7	P	NBR
1.500	1.816	.281	12316 ALLL16	P	FKM
1.500	1.874	.250	1500-1874-250ETBN	TB	NBR
1.500	1.874	.250	1500-1874-250EVBN	VB	NBR
1.500	1.875	.187	TMAL 1875-1212	TMAL	PTFE
1.500	1.875	.187	TN 1875-1212	TN	N/P
1.500	1.875	.250	TMAS 1875-1612	TMAS	PTFE
1.500	1.906	.438	11734 ALLL7	P	NBR
1.500	1.938	.250	4727 414	DS	CR
1.500	1.956	.250	19490 H1L5	LUP	NBR
1.500	1.956	.250	19490 H5L16PTFE	LUP	F/P
1.500	1.968	.312	19989 H1L5	LUP	NBR
1.500	1.968	.312	19989 H1L5 PTFE	LUP	N/P

See Section 4 for seal type description. For High Misalignment sizes, see Page B-86. For FlexiSeal Listings, see Pages B-93 and B-97.

03/03/06



Rotary Lip Seal Inch Sizes

1.500 to 1.500

B

Shaft Dia.	Bore Dia.	Seal Width	Parker Part Number	Seal Type	Material
1.500	1.983	.188	1500-1983-188EVBN	VB	NBR
1.500	1.983	.250	1500-1983-250ETBN	TB	NBR
1.500	1.984	.656	12136 H1L7	P	NBR
1.500	2.000	.250	12692 H1L7	H	NBR
1.500	2.000	.250	9831 H1L5	LUP	NBR
1.500	2.000	.250	9831 H5L16	LUP	FKM
1.500	2.000	.250	9831 H5L16 PTFE	LUP	F/P
1.500	2.000	.250	TN 2000-1616	TN	N/P
1.500	2.000	.250	1500-2000-250EVBN	VB	NBR
1.500	2.000	.313	0502 LDN 250 01500 313 VN	LDN	PTFE
1.500	2.000	.313	11654 H1L5	LUP	NBR
1.500	2.000	.313	11654 H1L5 PTFE	LUP	N/P
1.500	2.000	.313	11654 H1L70	LUP	NBR
1.500	2.000	.313	11654 H5L16	LUP	FKM
1.500	2.000	.313	9817 H1L5	RPD	NBR
1.500	2.000	.313	1500-2000-313ETBN	TB	NBR
1.500	2.062	.210	1500-2062-210EVBN	VB	NBR
1.500	2.062	.313	0502 LDN 281 01500 313 VN	LDN	PTFE
1.500	2.062	.313	1500-2062-313ETBN	TB	NBR
1.500	2.125	.250	TMAL 2125-1620	TMAL	PTFE
1.500	2.125	.313	0502 LDN 313 01500 313 VN	LDN	PTFE
1.500	2.125	.313	0150 9628	SPLIT	NBR
1.500	2.125	.437	TMAL 2125-2820	TMAL	PTFE
1.500	2.125	.438	6679 H1L5	LUP	NBR
1.500	2.125	.438	6679 H1L5 PTFE	LUP	N/P
1.500	2.125	.438	6679 H1L70	LUP	NBR
1.500	2.125	.438	6679 H5L16	LUP	FKM
1.500	2.188	.375	11278 H1L5	LPD	NBR
1.500	2.188	.375	11278 H5L16	LPD	FKM
1.500	2.250	.250	12184 H1L5	LUP	NBR
1.500	2.250	.250	12184 H1L5 PTFE	LUP	N/P
1.500	2.250	.250	12184 H5L16	LUP	FKM
1.500	2.250	.250	12184 H5L16 PTF	LUP	F/P
1.500	2.250	.250	11272 H1L7	SS	NBR
1.500	2.250	.250	11272 H1L7 PTFE	SS	N/P
1.500	2.250	.250	1500-2250-250EVBN	VB	NBR
1.500	2.250	.313	0502 LDN 375 01500 313 VN	LDN	PTFE
1.500	2.250	.313	1500-2250-313ETBN	TB	NBR
1.500	2.250	.375	17375 H1L5	B	NBR
1.500	2.250	.375	10572 H1L5	H	NBR
1.500	2.250	.375	10572 H1L7	H	NBR
1.500	2.250	.375	15409 5066	HP	FKM
1.500	2.250	.375	15409 5066 304	HP	FKM
1.500	2.250	.375	15409 5066 316	HP	FKM
1.500	2.250	.375	7033 H1L5	LUP	NBR
1.500	2.250	.375	7033 H1L5 PTFE	LUP	N/P
1.500	2.250	.375	7033 H1L7	LUP	NBR
1.500	2.250	.375	7033 H1L20	LUP	XNBR
1.500	2.250	.375	7033 H5L16	LUP	FKM
1.500	2.250	.375	7033 H5L16 PTFE	LUP	F/P
1.500	2.250	.375	3815 H1L5	RUP	NBR
1.500	2.250	.375	0150 13202	SPLIT	NBR
1.500	2.250	.375	0150 8899	SPLIT	NBR
1.500	2.250	.375	0150 8899 V	SPLIT	FKM
1.500	2.250	.375	5821 H1L7	SS	NBR
1.500	2.250	.375	5821 H1L7 PTFE	SS	N/P
1.500	2.250	.375	5821 H5L16	SS	FKM
1.500	2.250	.375	TMAL 2250-2424	TMAL	PTFE
1.500	2.250	.438	9688 H1L5	LUP	NBR
1.500	2.250	.438	9688 H1L5 PTFE	LUP	N/P
1.500	2.250	.438	9688 H5L16	LUP	FKM
1.500	2.250	.500	0150 4206	SPLIT	NBR
1.500	2.254	.343	20640 H1L5	LPDEL	NBR
1.500	2.254	.344	10172 H1L5	LPD	NBR
1.500	2.254	.344	10172 H5M5489	LPD	FKM
1.500	2.313	.375	11775 414	DS	CR

Shaft Dia.	Bore Dia.	Seal Width	Parker Part Number	Seal Type	Material
1.500	2.328	.375	13159 H1L5	LPD	NBR
1.500	2.374	.313	0502 LDN 437 01500 313 VN	LDN	PTFE
1.500	2.374	.313	1500-2374-313ETBN	TB	NBR
1.500	2.375	.313	0150 5867	SPLIT	NBR
1.500	2.375	.313	0150 5867 VPTFE	SPLIT	F/P
1.500	2.375	.375	11100 H1L5	LPD	NBR
1.500	2.375	.375	11100 H1L5 PTFE	LPD	N/P
1.500	2.375	.375	11100 H5L16	LPD	FKM
1.500	2.375	.500	11172 H1L5	LPD	NBR
1.500	2.375	.500	11172 H5L16	LPD	FKM
1.500	2.380	.375	0150 7182	SPLIT	NBR
1.500	2.437	.313	0502 LDN 469 01500 313 VN	LDN	PTFE
1.500	2.437	.313	1500-2437-313ETBN	TB	NBR
1.500	2.438	.250	1500-2438-250EVBN	VB	NBR
1.500	2.441	.313	0502 LDN 471 01500 313 VN	LDN	PTFE
1.500	2.442	.500	8381 H1L5	RPD	NBR
1.500	2.442	.500	8381 H5L16	RPD	FKM
1.500	2.500	.250	TMAL 2500-1632	TMAL	PTFE
1.500	2.500	.375	9952 H1L5	LUP	NBR
1.500	2.500	.375	9952 H1L5 PTFE	LUP	N/P
1.500	2.500	.375	9952 H5L16	LUP	FKM
1.500	2.500	.375	11980 H1L20PTFE	SSW	XN/P
1.500	2.500	.375	11980 H1L5	SSW	NBR
1.500	2.500	.375	11980 H5L16	SSW	FKM
1.500	2.500	.375	TMAL 2500-2432	TMAL	PTFE
1.500	2.500	.438	9483 H1L5	LPD	NBR
1.500	2.500	.438	9483 H1L5 PTFE	LPD	N/P
1.500	2.500	.438	10477 H1L5	RPD	NBR
1.500	2.500	.438	10477 H1L50	RPD	NBR
1.500	2.500	.438	10477 H5L16	RPD	FKM
1.500	2.500	.438	16174 H1L5	LUP	NBR
1.500	2.500	.438	0150 4399	SPLIT	NBR
1.500	2.500	.438	0150 4399 V	SPLIT	FKM
1.500	2.500	.438	TMAL 2500-2832	TMAL	PTFE
1.500	2.500	.500	14618 H1L5	LDS	NBR
1.500	2.500	.500	14618 H1L7	LDS	NBR
1.500	2.500	.500	14618 H5M5489	LDS	FKM
1.500	2.500	.500	9041 H1L5	LUP	NBR
1.500	2.500	.500	9041 H1L5 PTFE	LUP	N/P
1.500	2.500	.500	9041 H5L16	LUP	FKM
1.500	2.500	.500	TMAL 2500-3232	TMAL	PTFE
1.500	2.502	.312	1500-2502-312ETBN	TB	NBR
1.500	2.502	.313	0502 LDN 501 01500 313 VN	LDN	PTFE
1.500	2.507	.500	0150 5633	SPLIT	NBR
1.500	2.561	.313	0502 LDN 531 01500 313 VN	LDN	PTFE
1.500	2.561	.313	1500-2561-313ETBN	TB	NBR
1.500	2.565	.500	5414 H1L5	LUP	NBR
1.500	2.623	.250	1500-2623-250ETBN	TB	NBR
1.500	2.623	.313	0502 LDN 562 01500 313 VN	LDN	PTFE
1.500	2.625	.375	0150 6848	SPLIT	NBR
1.500	2.625	.438	9056 H1L5	LUP	NBR
1.500	2.625	.438	9056 H5L16	LUP	FKM
1.500	2.750	.313	0502 LDN 625 01500 313 VN	LDN	PTFE
1.500	2.750	.313	1500-2750-313ETBN	TB	NBR
1.500	2.750	.375	19338 H5L16	LUP	FKM
1.500	2.750	.375	5734 H1L5	LUP	NBR
1.500	2.750	.375	5734 H1L5 PTFE	LUP	N/P
1.500	2.750	.375	5734 H5L16	LUP	FKM
1.500	2.750	.500	12294 H1L5	LPD	NBR
1.500	2.756	.438	5696 H1L5	LUP	NBR
1.500	2.758	.500	15143 H1L5	LDS	NBR
1.500	2.773	.375	0150 7181	SPLIT	NBR
1.500	2.835	.313	0502 LDN 668 01500 313 VN	LDN	PTFE
1.500	2.835	.313	1500-2835-313ETBN	TB	NBR
1.500	2.882	.375	19281 H1L5	LUP	NBR
1.500	2.882	.375	19281 H5L89	LUP	FKM

See Section 4 for seal type description. For High Misalignment sizes, see Page B-86. For FlexiSeal Listings, see Pages B-93 and B-97.

03/03/06



B

Shaft Dia.	Bore Dia.	Seal Width	Parker Part Number	Seal Type	Material
1.500	3.000	.375	19670 H1L5	LUP	NBR
1.500	3.125	.250	13757 ALLL7	SSW	NBR
1.500	3.250	.812	TMAS 3250-5256	TMAS	PTFE
1.500	3.688	.500	18607 H1L5	LUP	NBR
1.500	3.750	.500	18752 H1L5	LUP	NBR
1.500	3.800	.438	12352 H1L5	RPD	NBR
1.500	4.000	.687	13892 ALLL16	SPCL	FKM
1.501	2.063	.250	TN2063-1618 304	TN	N/P
1.504	2.500	.250	5619 H1L7	SS	NBR
1.504	2.500	.250	5619 H1L7 PTFE	SS	N/P
1.504	2.500	.250	5619 H5L16	SS	FKM
1.530	2.312	.375	TMAL 2312-2425	TMAL	PTFE
1.530	2.755	.500	9893 H1L5	LPD	NBR
1.531	2.338	.250	13134 ALLL5	LPDW	NBR
1.531	2.500	.438	9923 H1L5	LPDW	NBR
1.531	2.755	.500	9893 H1L5	LPD	NBR
1.532	2.063	.250	15924 H1L5	LUP	NBR
1.532	2.157	.313	0153 9628	SPLIT	NBR
1.532	2.411	.375	0153 7182	SPLIT	NBR
1.557	1.848	.122	18313 ALLL5	SS	NBR
1.560	2.125	.125	19669 H1L5	LUP	NBR
1.560	2.677	.250	11892 H1L5	LUP	NBR
1.560	3.150	.375	19550 H1L5	LUP	NBR
1.562	2.250	.312	TMAL 2250-2022	TMAL	PTFE
1.562	2.250	.375	6836 H1L5	LUP	NBR
1.562	2.250	.375	6836 H1L7	LUP	NBR
1.562	2.250	.375	6836 H5L16	LUP	FKM
1.562	2.250	.375	6836 H5L16 PTFE	LUP	F/P
1.562	2.250	.437	4186 H1L5	RUP	NBR
1.562	2.250	.594	17953 H1L5	LDS	NBR
1.562	2.438	.438	11514 H1L5	LPD	NBR
1.562	2.438	.438	11514 H5MX5489	LPD	FKM
1.562	2.500	.375	15198 H1L5	LPD	NBR
1.562	2.500	.375	15198 H5L16	LPD	FKM
1.562	2.500	.500	5536 H1L5	LUP	NBR
1.562	2.500	.500	5536 H1L5 PTFE	LUP	N/P
1.562	2.500	.500	5536 H1L21	LUP	EPDM
1.562	2.500	.500	5536 H5L16	LUP	FKM
1.562	2.500	.562	15770 H1L5	LDS	NBR
1.562	2.686	.375	20760 H1L5	LUP	NBR
1.562	3.250	.812	TMAS 3250-5254	TMAS	PTFE
1.563	2.062	.203	1563-2062-203EVBN	VB	NBR
1.563	2.063	.313	5866 H1L5	RPD	NBR
1.563	2.125	.313	0502 LDN 281 01563 313 VN	LDN	PTFE
1.563	2.125	.313	1563-2125-313ETBN	TB	NBR
1.563	2.188	.313	11429 H1L5	LPD	NBR
1.563	2.188	.313	11429 H5L16	LPD	FKM
1.563	2.188	.313	4450 H1L5	RPD	NBR
1.563	2.188	.313	4450 H5L16	RPD	FKM
1.563	2.188	.313	0156 9628	SPLIT	NBR
1.563	2.250	.313	0502 LDN 344 01563 313 VN	LDN	PTFE
1.563	2.250	.313	1563-2250-313ETBN	TB	NBR
1.563	2.250	.344	16400 5066	HP	FKM
1.563	2.250	.344	16400 5066 304	HP	FKM
1.563	2.250	.344	16400 5066 316	HP	FKM
1.563	2.312	.375	0156 9584	SPLIT	NBR
1.563	2.313	.375	0156 13202	SPLIT	NBR
1.563	2.313	.500	0156 4206	SPLIT	NBR
1.563	2.374	.313	0502 LDN 406 01563 313 VN	LDN	PTFE
1.563	2.374	.313	1563-2374-313ETBN	TB	NBR
1.563	2.375	.438	14019 H1L5	LUP	NBR
1.563	2.375	.500	17486 H1L5	LUP	NBR
1.563	2.375	.500	17486 H5L16	LUP	FKM
1.563	2.375	.500	4281 H1L5	RUP	NBR
1.563	2.436	.469	9445 H1L5	LPD	NBR
1.563	2.436	.469	9445 H5L16	LPD	FKM

Shaft Dia.	Bore Dia.	Seal Width	Parker Part Number	Seal Type	Material
1.563	2.437	.313	0502 LDN 437 01563 313 VN	LDN	PTFE
1.563	2.437	.313	1563-2437-313ETBN	TB	NBR
1.563	2.438	.313	0156 5867	SPLIT	NBR
1.563	2.438	.438	3691 H1L5	RPD	NBR
1.563	2.438	.438	3691 H5L16	RPD	FKM
1.563	2.441	.313	0502 LDN 439 01563 313 VN	LDN	PTFE
1.563	2.441	.500	1563-2441-500ETBN	TB	NBR
1.563	2.442	.375	0156 7182	SPLIT	NBR
1.563	2.500	.313	17973 5066	HP	FKM
1.563	2.500	.313	17973 5066 304	HP	FKM
1.563	2.500	.313	17973 5066 316	HP	FKM
1.563	2.502	.250	1563-2502-250EVBN	VB	NBR
1.563	2.502	.313	0502 LDN 470 01563 313 VN	LDN	PTFE
1.563	2.502	.313	1563-2502-313ETBN	TB	NBR
1.563	2.569	.500	0156 5633	SPLIT	NBR
1.563	2.625	.438	18844 5066	HP	FKM
1.563	2.625	.438	18844 5066 304	HP	FKM
1.563	2.625	.500	5627 H1L5	LPD	NBR
1.563	2.625	.500	5627 H5L16	LPD	FKM
1.563	2.750	.375	11808 H1L5	RPD	NBR
1.563	2.783	.438	16386 H1L5	LUP	NBR
1.563	2.835	.375	0156 7181	SPLIT	NBR
1.563	3.543	.375	10190 H1L5	LPD	NBR
1.563	3.543	.375	10190 H5L89	LPD	FKM
1.573	3.150	.375	13285 H1L5	LDS	NBR
1.575	1.938	.188	18870 H3L8	SS	CR
1.575	1.968	.315	30170 H1L5	SS	NBR
1.575	2.047	.250	20426 MX5489	MP	FKM
1.575	2.047	.354	15305 H1L7	P	NBR
1.575	2.165	.236	19811 H1L5	LUP	NBR
1.575	2.205	.315	17405 H1L5	LUP	NBR
1.575	2.205	.354	14709 H1L7	P	NBR
1.575	2.205	.394	14577 H1L5	LPD	NBR
1.575	2.441	.315	30038 H1L5	LUP	NBR
1.575	2.441	.395	13177 H1L5	SSW	NBR
1.575	2.500	.375	11302 H1L5	LUP	NBR
1.575	2.500	.375	11302 H1L5 PTFE	LUP	N/P
1.575	2.500	.375	11302 H5L16	LUP	FKM
1.575	2.677	.250	19658 H1L5 PTFE	SS	N/P
1.575	2.677	.433	18329 H1L5	LUP	NBR
1.575	2.677	.433	18329 H1L5 PTFE	LUP	N/P
1.576	2.406	.250	11495 414	DS	CR
1.576	2.500	.500	11498 H1L5	LPD	NBR
1.578	2.328	.375	0157 8899	SPLIT	NBR
1.579	2.328	.375	19834 H1L5	LUP	NBR
1.594	2.219	.313	0159 9628	SPLIT	NBR
1.594	2.502	.500	11365 H1L5	RPD	NBR
1.594	2.620	.500	14964 H1L5	LPD	NBR
1.600	2.375	.375	14838 H1L5	LPD	NBR
1.600	2.375	.375	14838 H5L16	LPD	FKM
1.615	2.375	.375	4459 H1L5	RUP	NBR
1.620	2.438	.406	7365 H1L5	LUP	NBR
1.620	2.438	.406	7365 H1L5 PTFE	LUP	N/P
1.620	2.441	.438	6323 H1L7	SS	NBR
1.620	2.441	.438	6323 H5L16	SS	FKM
1.624	2.437	.312	TMAL 2437-2026	TMAL	PTFE
1.625	1.938	.313	5326 H3L8	SS	CR
1.625	1.938	.313	5326 H5L16	SS	FKM
1.625	2.000	.250	1625-2000-250ETBN	TB	NBR
1.625	2.004	.328	12318 ALLL7	P	NBR
1.625	2.125	.250	19248 H1L5	LUP	NBR
1.625	2.125	.250	19248 H1L2160	LUP	EPDM
1.625	2.125	.250	19248 H5L16	LUP	FKM
1.625	2.125	.250	20451 H5L89PTFE	LUP	F/P
1.625	2.125	.250	1625-2125-250ETBN	TB	NBR
1.625	2.125	.250	1625-2125-250EVBN	VB	NBR

See Section 4 for seal type description. For High Misalignment sizes, see Page B-86. For FlexiSeal Listings, see Pages B-93 and B-97.

03/03/06



Rotary Lip Seal Inch Sizes

1.625 to 1.688

B

Shaft Dia.	Bore Dia.	Seal Width	Parker Part Number	Seal Type	Material
1.625	2.125	.313	0502 LDN 250 01625 313 VN	LDN	PTFE
1.625	2.188	.375	15472 H1L5	LDS	NBR
1.625	2.188	.375	10752 H1L5	LPD	NBR
1.625	2.188	.375	10752 H5L16	LPD	FKM
1.625	2.250	.313	16794 5066	HP	FKM
1.625	2.250	.313	16794 5066 304	HP	FKM
1.625	2.250	.313	16794 5066 316	HP	FKM
1.625	2.250	.313	19869 5066	HP	FKM
1.625	2.250	.313	0502 LDN 313 01625 313 VN	LDN	PTFE
1.625	2.250	.313	0162 9628	SPLIT	NBR
1.625	2.250	.313	1625-2250-313ETBN	TB	NBR
1.625	2.330	.454	19817 H1L5	LUPW	NBR
1.625	2.374	.313	0502 LDN 375 01625 313 VN	LDN	PTFE
1.625	2.374	.313	1625-2374-313ETBN	TB	NBR
1.625	2.375	.313	19239 H1L5	LUP	NBR
1.625	2.375	.313	19239 H1L5 PTFE	LUP	N/P
1.625	2.375	.375	15969 5066	HP	FKM
1.625	2.375	.375	15969 5066 304	HP	FKM
1.625	2.375	.375	15969 5066 316	HP	FKM
1.625	2.375	.375	15969 5066 EPDM	HP	EPDM
1.625	2.375	.375	7073 H1L5	LUP	NBR
1.625	2.375	.375	7073 H5L16	LUP	FKM
1.625	2.375	.375	19040 5489	MP	FKM
1.625	2.375	.375	8899 H1L5	RPD	NBR
1.625	2.375	.375	8899 H1L5 PTFE	RPD	N/P
1.625	2.375	.375	8899 H5L16	RPD	FKM
1.625	2.375	.375	0162 9584	SPLIT	NBR
1.625	2.375	.375	6419 H1L7	SS	N/P
1.625	2.375	.375	6419 PTFE	SS	N/P
1.625	2.375	.500	6001 H1L5	LA	NBR
1.625	2.375	.500	17687 H1L5	LDS	NBR
1.625	2.375	.500	0162 4206	SPLIT	NBR
1.625	2.437	.313	0502 LDN 406 01625 313 VN	LDN	PTFE
1.625	2.437	.313	1625-2437-313ETBN	TB	NBR
1.625	2.438	.375	12007 H1L5	LPD	NBR
1.625	2.438	.375	17709 H1L7	SS	NBR
1.625	2.438	.375	TMAL 2438-2426	TMAL	PTFE
1.625	2.438	.438	0162 6112	SPLIT	NBR
1.625	2.438	.500	13517 H1L5	LDS	NBR
1.625	2.441	.313	0502 LDN 408 01625 313 VN	LDN	PTFE
1.625	2.441	.313	1625-2441-313ETBN	TB	NBR
1.625	2.500	.250	0162 10872	SPLIT	NBR
1.625	2.500	.313	0162 5867	SPLIT	NBR
1.625	2.500	.375	TMAL 2500-2428	TMAL	PTFE
1.625	2.500	.375	TMAS 2500-2428	TMAS	PTFE
1.625	2.500	.438	3965 H1L5	LPD	NBR
1.625	2.500	.438	3965 HL170	LPD	NBR
1.625	2.500	.438	0162 9560	SPLIT	NBR
1.625	2.500	.438	0162 9560 V	SPLIT	FKM
1.625	2.500	.500	16515 H1L5	LDS	NBR
1.625	2.500	.500	16515 H5L16	LDS	FKM
1.625	2.502	.313	0502 LDN 439 01625 313 VN	LDN	PTFE
1.625	2.502	.313	1625-2502-313ETBN	TB	NBR
1.625	2.502	.375	10060 H1L5	LPD	NBR
1.625	2.502	.375	10060 H5L16	LPD	FKM
1.625	2.502	.500	6056 H1L5	LUP	NBR
1.625	2.502	.500	6056 H5L16	LUP	FKM
1.625	2.506	.500	15105 H1L5	LDS	NBR
1.625	2.506	.500	15105 H1L5 PTFE	LDS	N/P
1.625	2.562	.250	1625-2562-250EVBN	VB	NBR
1.625	2.563	.500	19067 H1L5	RPD	NBR
1.625	2.623	.313	0502 LDN 499 01625 313 VN	LDN	PTFE
1.625	2.623	.313	1625-2623-313ETBN	TB	NBR
1.625	2.625	.375	10035 H1L5	LPD	NBR
1.625	2.625	.438	9636 H1L5	LUP	NBR
1.625	2.625	.438	9636 H1L2160	LUP	EPDM

Shaft Dia.	Bore Dia.	Seal Width	Parker Part Number	Seal Type	Material
1.625	2.625	.438	9636 H5L16	LUP	FKM
1.625	2.625	.438	4399 H1L5	RUP	NBR
1.625	2.625	.438	4399 H5L16	RUP	FKM
1.625	2.625	.500	6509 H1L5	LA	NBR
1.625	2.631	.500	0162 5633	SPLIT	NBR
1.625	2.686	.313	0502 LDN 531 01625 313 VN	LDN	PTFE
1.625	2.686	.375	1625-2686-375ETBN	TB	NBR
1.625	2.688	.500	17745 H1L5	LUP	NBR
1.625	2.688	.500	TMAL 2688-3234	TMAL	PTFE
1.625	2.717	.375	19218 H1L5	LDS	NBR
1.625	2.717		19218 H5L16	LDS	FKM
1.625	2.720	.375	20428 H1L5	LUP	NBR
1.625	2.720	.375	20428 H5L89	LUP	FKM
1.625	2.750	.313	0502 LDN 563 01625 313 VN	LDN	PTFE
1.625	2.750	.250	1625-2750-250ETBN	TB	NBR
1.625	2.750	.375	6848 H1L5	R	NBR
1.625	2.750	.500	10405 H1L5	LPD	NBR
1.625	2.875	.500	9849 H1L5	LUP	NBR
1.625	2.875	.500	9849 H5L16	LUP	FKM
1.625	2.938	.438	0162 9302	SPLIT	FKM
1.625	3.063	.500	0162 17457	SPLIT	NBR
1.625	3.500	.500	13370 H1L5	SSW	NBR
1.625	3.500	.500	13370 H1L2160	SSW	EPDM
1.625	3.500	.500	13370 H5L89	SSW	FKM
1.640	3.000	.406	20713 H1L5	SSW	NBR
1.643	2.750	.500	13702 H1L5	LPD	NBR
1.680	2.378	.218	19739 H1L5	SS	NBR
1.680	3.191	.187	19738 H1L5	SS	NBR
1.687	2.625	.469	60026 H1L5	LDS	NBR
1.687	2.625	.500	60023 H1L5	LDS	NBR
1.687	2.687	.375	TMAL 2687-2432	TMAL	PTFE
1.688	2.125	.188	17955 H1L7	SS	NBR
1.688	2.188	.250	15714 5066	HP	FKM
1.688	2.188	.250	15714 5066 304	HP	FKM
1.688	2.188	.250	15714 5066 316	HP	FKM
1.688	2.313	.313	11428 H1L5	LPD	NBR
1.688	2.313	.313	11428 H5L16	LPD	FKM
1.688	2.313	.313	0168 4435	SPLIT	NBR
1.688	2.313	.375	0168 18156	SPLIT	NBR
1.688	2.328	.313	0502 LDN 320 01688 313 VN	LDN	PTFE
1.688	2.328	.313	1688-2328-313ETBN	TB	NBR
1.688	2.375	.313	8815 H1L5	LUP	NBR
1.688	2.375	.313	8815 H5L16	LUP	FKM
1.688	2.438	.313	0502 LDN 375 01688 313 VN	LDN	PTFE
1.688	2.438	.313	1688-2438-313ETBN	TB	NBR
1.688	2.438	.375	5690 H1L5	LPD	NBR
1.688	2.438	.375	5690 H5L16	LPD	FKM
1.688	2.438	.375	13202 H1L5	RPD	NBR
1.688	2.438	.375	0168 9584	SPLIT	NBR
1.688	2.438	.375	TMAL 2438-2424	TMAL	PTFE
1.688	2.438	.438	4765 H1L5	B	NBR
1.688	2.446	.438	0168 3716	SPLIT	NBR
1.688	2.500	.250	13464 H1L5	OLLPD	NBR
1.688	2.500	.313	0502 LDN 406 01688 313 VN	LDN	PTFE
1.688	2.500	.313	1688-2500-313ETBN	TB	NBR
1.688	2.500	.375	5669 H1L5	LA	NBR
1.688	2.500	.438	0168 6112	SPLIT	NBR
1.688	2.500	.500	10250 H1L5	LUP	NBR
1.688	2.500	.500	10250 H5L16	LUP	FKM
1.688	2.500	.563	15767 H1L5	LDS	NBR
1.688	2.502	.313	0502 LDN 407 01688 313 VN	LDN	PTFE
1.688	2.502	.313	1688-2502-313ETBN	TB	NBR
1.688	2.502	.375	10054 H1L5	LUP	NBR
1.688	2.502	.375	10054 H5L16	LUP	FKM
1.688	2.561	.313	0502 LDN 437 01688 313 VN	LDN	PTFE
1.688	2.563	.250	0168 10872	SPLIT	NBR

See Section 4 for seal type description. For High Misalignment sizes, see Page B-86. For FlexiSeal Listings, see Pages B-93 and B-97.

03/03/06



B

Shaft Dia.	Bore Dia.	Seal Width	Parker Part Number	Seal Type	Material
1.688	2.563	.313	0168 5867	SPLIT	NBR
1.688	2.563	.313	0168 5867 V	SPLIT	FKM
1.688	2.563	.438	0168 9560	SPLIT	NBR
1.688	2.563	.500	6689 H1L5	LUP	NBR
1.688	2.563	.500	6689 H5MX5489	LUP	FKM
1.688	2.567	.375	7182 H1L5	RPD	NBR
1.688	2.567	.375	7182 H5L16	RPD	FKM
1.688	2.623	.313	0502 LDN 468 01688 313 VN	LDN	PTFE
1.688	2.623	.313	1688-2623-313ETBN	TB	NBR
1.688	2.623	.375	9935 H1L7	SS	NBR
1.688	2.623	.375	9935 H1L7 PTFE	SS	N/P
1.688	2.623	.375	9935 H5L16	SS	FKM
1.688	2.625	.500	16467 H1L5	LDS	NBR
1.688	2.625	.500	16467 H5L16	LDS	FKM
1.688	2.625	.500	18316 H1L5	LDS	NBR
1.688	2.625	.500	16241 H1L5	LUP	NBR
1.688	2.625	.500	16241 H5L16	LUP	FKM
1.688	2.625	.500	0168 5828	SPLIT	NBR
1.688	2.688	.437	TMAL 2688-2832	TMAL	PTFE
1.688	2.688	.438	7031 H1L3	LUP	CR
1.688	2.688	.438	7031 H1L5	LUP	NBR
1.688	2.688	.438	7031 H5L16	LUP	FKM
1.688	2.688	.438	7031 H5L16 PTFE	LUP	F/P
1.688	2.688	.500	6122 H1L5	LUP	NBR
1.688	2.688	.500	6122 H5L16	LUP	FKM
1.688	2.693	.688	0168 6047	SPLIT	NBR
1.688	2.719	.375	11699 H1L5	LPD	NBR
1.688	2.750	.188	9091 414	DS	CR
1.688	2.750	.438	9395 H1L5	LUP	NBR
1.688	2.750	.438	9395 H5L16	LUP	FKM
1.688	2.750	.438	0168 3697	SPLIT	NBR
1.688	2.750	.500	8861 H1L7	SS	NBR
1.688	2.750	.500	8861 H1L7 PTFE	SS	N/P
1.688	2.847	.500	16925 H1L5	LDS	NBR
1.688	2.847	.500	17631 H1L5	LDS	NBR
1.688	2.847	.500	17631 H5L16	LDS	FKM
1.688	2.875	.313	0502 LDN 594 01688 313 VN	LDN	PTFE
1.688	2.875	.469	1688-2875-469ETBN	TB	NBR
1.688	2.897	.500	16665 H1L5	LUP	NBR
1.688	2.960	.375	7181 H1L5	RPD	NBR
1.688	3.000	.406	14336 H1L5	SSW	NBR
1.688	3.000	.438	0168 9302	SPLIT	NBR
1.688	3.063	.375	11015 H1L5	LPD	NBR
1.688	3.543	.375	14355 H1L5	LPD	NBR
1.691	2.441	.375	TMAL 2441-2424	TMAL	PTFE
1.693	3.750	.313	17019 H1L5	SSW	NBR
1.693	3.750	.313	17019 H5L89	SSW	FKM
1.719	2.594	.438	0171 9560	SPLIT	NBR
1.719	2.755	.500	5480 H1L5	LPD	NBR
1.719	2.755	.500	5480 H1L5 PTFE	LPD	N/P
1.719	3.000	.375	9167 H1L7	SS	NBR
1.730	2.438	.469	11881 H1L5	LPD	NBR
1.731	2.440	.300	19375 H1L5	P	NBR
1.738	1.992	.170	17315 ALLL5	SS	NBR
1.742	2.430	.375	TMAL 2430-2422	TMAL	PTFE
1.744	2.547	.300	13249 ALLL5	LPDW	NBR
1.745	2.250	.313	15923 H1L5	LUP	NBR
1.745	2.250	.313	15923 H5L16	LUP	FKM
1.748	2.156	.250	4748 414	DS	CR
1.748	2.375	.250	11817 H1L5	SSW	NBR
1.748	2.375	.250	11817 H5L16	SSW	FKM
1.748	2.624	.438	11813 H1L5	LPDW	NBR
1.748	2.625	.375	17320 H1L5	SSW	NBR
1.748	2.625	.375	17320 H5L16	SSW	FKM
1.749	2.437	.312	TMAL 2437-2022	TMAL	PTFE
1.750	2.125	.188	12262 ALLL5	SS	NBR

Shaft Dia.	Bore Dia.	Seal Width	Parker Part Number	Seal Type	Material
1.750	2.125	.188	8854 H1L7	SS	NBR
1.750	2.125	.188	8854 H1L70	SS	NBR
1.750	2.125	.188	1750-2125-188ETBN	TB	NBR
1.750	2.129	.328	12319 ALLL7	P	NBR
1.750	2.156	.438	11885 ALLL7	P	NBR
1.750	2.250	.188	1750-2250-188EVBN	VB	NBR
1.750	2.250	.250	19443 H1L7	P	NBR
1.750	2.250	.250	0175 13524	SPLIT	NBR
1.750	2.250	.313	5993 H1L5 PTFE	SS	N/P
1.750	2.250	.313	5993 H1L7	SS	NBR
1.750	2.250	.313	5993 H1L20	SS	XNBR
1.750	2.250	.313	5993 H5L16	SS	FKM
1.750	2.313	.250	11041 H1L7	SS	NBR
1.750	2.313	.375	11774 414	DS	CR
1.750	2.374	.313	0502 LDN 312 01750 313 VN	LDN	PTFE
1.750	2.374	.313	1750-2374-313ETBN	TB	NBR
1.750	2.375	.250	0175 9858	SPLIT	NBR
1.750	2.375	.313	TMAL 2375-2020	TMAL	PTFE
1.750	2.375	.313	11822 H1L7	SS	NBR
1.750	2.375	.313	11822 H5L16	SS	FKM
1.750	2.375	.313	0175 4435	SPLIT	NBR
1.750	2.375	.313	9628 H1L5	RUP	NBR
1.750	2.375	.313	9628 H5L16	RUP	FKM
1.750	2.375	.313	11518 H1L5	LPD	NBR
1.750	2.375	.313	11518 H1L5 PTFE	LPD	N/P
1.750	2.375	.313	11518 H5L16	LPD	FKM
1.750	2.375	.375	0175 18156	SPLIT	NBR
1.750	2.375	.375	TMAL 2375-2420	TMAL	PTFE
1.750	2.437	.313	0502 LDN 344 01750 313 VN	LDN	PTFE
1.750	2.437	.313	16159 H1L5	LPD	NBR
1.750	2.437	.313	16159 H5L16	LPD	FKM
1.750	2.437	.313	1750-2437-313ETBN	TB	NBR
1.750	2.437	.375	0175 3975	SPLIT	NBR
1.750	2.438	.313	0502 LDN 344 01750 313 VN	LDN	PTFE
1.750	2.438	.313	13737 ALLL5	MCL	NBR
1.750	2.438	.313	1750-2438-313ETBN	TB	NBR
1.750	2.438	.375	9799 H1L5	LPD	NBR
1.750	2.438	.375	9799 H1L70 PTFE	LPD	NBR
1.750	2.438	.375	9799 H5L16	LPD	FKM
1.750	2.438	.375	TMAL 2438-2422	TMAL	PTFE
1.750	2.441	.313	0502 LDN 346 01750 313 VN	LDN	PTFE
1.750	2.441	.313	1750-2441-313ETBN	TB	NBR
1.750	2.441	.375	18419 H1L5	LDS	NBR
1.750	2.441	.375	18419 H5L89	LDS	FKM
1.750	2.455	.250	18429 H1L5	LDS	NBR
1.750	2.500	.312	14849 H1L5	LPD	NBR
1.750	2.500	.312	14849 H1L5 PTFE	LPD	N/P
1.750	2.500	.312	14849 H1L70	LPD	NBR
1.750	2.500	.312	14849 H5L16	LPD	FKM
1.750	2.500	.312	14849 L70	LPD	NBR
1.750	2.500	.375	15898 5066	HP	FKM
1.750	2.500	.375	15898 5066 304	HP	FKM
1.750	2.500	.375	15898 5066 316	HP	FKM
1.750	2.500	.375	15898 5066 EPDM	HP	EPDM
1.750	2.500	.375	9854 H1L5	LUP	NBR
1.750	2.500	.375	9854 H1L5 PTFE	LUP	N/P
1.750	2.500	.375	9854 H1L7	LUP	NBR
1.750	2.500	.375	9854 H5L16	LUP	FKM
1.750	2.500	.375	12617 H1L7	P	NBR
1.750	2.500	.375	0175 3879	SPLIT	NBR
1.750	2.500	.375	0175 3879 V	SPLIT	FKM
1.750	2.500	.375	TMAL 2500-2424	TMAL	PTFE
1.750	2.500	.438	16519 H1L5	LUP	NBR
1.750	2.500	.438	16519 H5L16	LUP	FKM
1.750	2.500	.438	60005 H1L5	SPC	NBR
1.750	2.500	.500	4206 H1L5	RPD	NBR

See Section 4 for seal type description. For High Misalignment sizes, see Page B-86.
For FlexiSeal Listings, see Pages B-93 and B-97.

03/03/06



Rotary Lip Seal Inch Sizes

1.750 to 1.772

B

Shaft Dia.	Bore Dia.	Seal Width	Parker Part Number	Seal Type	Material
1.750	2.502	.250	14975 H1L21	LPD	EPDM
1.750	2.502	.250	14975 H1L5	LPD	NBR
1.750	2.502	.313	0502 LDN 376 01750 313 VN	LDN	PTFE
1.750	2.502	.313	1750-2502-313ETBN	TB	NBR
1.750	2.502	.500	15557 H1L5	LUP	NBR
1.750	2.502	.500	15557 H5L16	LUP	FKM
1.750	2.503	.500	19062 H1L21	LDS	EPDM
1.750	2.503	.500	19062 H1L5	LDS	NBR
1.750	2.503	.500	19062 H5L89	LDS	FKM
1.750	2.540	.325	20597 H1L5	P	NBR
1.750	2.561	.313	0502 LDN 406 01750 313 VN	LDN	PTFE
1.750	2.561	.313	1750-2561-313ETBN	TB	NBR
1.750	2.565	.313	0502 LDN 408 01750 313 VN	LDN	PTFE
1.750	2.565	.313	1750-2565-313ETBN	TB	NBR
1.750	2.623	.313	0502 LDN 437 01750 313 VN	LDN	PTFE
1.750	2.623	.313	1750-2623-313ETBN	TB	NBR
1.750	2.625	.313	9077 H1L5	LPD	NBR
1.750	2.625	.313	20639 H1L5	LPDEL	NBR
1.750	2.625	.313	5867 H1L5	RPD	NBR
1.750	2.625	.313	5867 H5L16	RPD	FKM
1.750	2.625	.313	5867 H5L89 PTFE	RPD	F/P
1.750	2.625	.438	17339 5066	HP	FKM
1.750	2.625	.438	17339 5066 304	HP	FKM
1.750	2.625	.438	17339 5066 316	HP	FKM
1.750	2.625	.438	18152 5066	HP	FKM
1.750	2.625	.438	18152 5066 304	HP	FKM
1.750	2.625	.438	18152 5066 316	HP	FKM
1.750	2.625	.438	18938 5066	HP	FKM
1.750	2.625	.438	10380 H1L5	LUP	NBR
1.750	2.625	.438	10380 H5L16	LUP	FKM
1.750	2.625	.438	0175 9560	SPLIT	NBR
1.750	2.625	.500	14621 H1L5	LDS	NBR
1.750	2.625	.500	14621 H5L89	LDS	FKM
1.750	2.625	.500	TMAL 2625-3228	TMAL	PTFE
1.750	2.625	.750	12047 H1L7	P	NBR
1.750	2.629	.500	5597 H1L5	LUP	NBR
1.750	2.656	.625	17068 H1L5	LUP	NBR
1.750	2.688	.375	12006 H1L5	LPD	NBR
1.750	2.688	.375	12006 H1L5 PTFE	LPD	N/P
1.750	2.688	.375	12006 H5L16	LPD	FKM
1.750	2.688	.438	9710 H1L5	LUP	NBR
1.750	2.688	.438	9710 H5L16	LUP	FKM
1.750	2.688	.500	5772 H1L5	LA	NBR
1.750	2.688	.500	5772 H5L16	LA	FKM
1.750	2.688	.500	0175 5828	SPLIT	NBR
1.750	2.717	.313	0502 LDN 484 01750 313 VN	LDN	PTFE
1.750	2.717	.438	1750-2717-438ETBN	TB	NBR
1.750	2.750	.270	14622 H1L5	SDS	NBR
1.750	2.750	.313	0502 LDN 500 01750 313 VN	LDN	PTFE
1.750	2.750	.313	13852 H1L5	LDS	NBR
1.750	2.750	.313	13852 H5MX5489	LDS	FKM
1.750	2.750	.313	1750-2750-313ETBN	TB	NBR
1.750	2.750	.375	16812 5066	HP	FKM
1.750	2.750	.375	16812 5066 304	HP	FKM
1.750	2.750	.375	16812 5066 316	HP	FKM
1.750	2.750	.375	4465 H1L5	LPD	NBR
1.750	2.750	.375	4465 H1L5 PTFE	LPD	N/P
1.750	2.750	.375	4465 H5L16	LPD	FKM
1.750	2.750	.375	4465 H5L16 PTFE	LPD	F/P
1.750	2.750	.375	TMAS 2750-2432	TMAS	PTFE
1.750	2.750	.438	17757 H1L5	LDS	NBR
1.750	2.750	.438	17757 H5MX5489	LDS	FKM
1.750	2.750	.500	16201 H1L7	H	NBR
1.750	2.750	.500	9955 H1L5	LUP	NBR
1.750	2.750	.500	9955 H1L5 PTFE	LUP	N/P
1.750	2.750	.500	9955 H5L89	LUP	FKM

Shaft Dia.	Bore Dia.	Seal Width	Parker Part Number	Seal Type	Material
1.750	2.750	.500	5633 H1L5	RPD	NBR
1.750	2.750	.500	0175 13328	SPLIT	NBR
1.750	2.750	.500	0175 9668	SPLIT	NBR
1.750	2.750	.500	10617 H1L5	SS	NBR
1.750	2.750	.500	10617 H1L7	SS	NBR
1.750	2.750	.500	10617 H1L7 PTFE	SS	N/P
1.750	2.756	.500	10617 H5L16	SS	FKM
1.750	2.809	.438	0175 9668 V	SPLIT	FKM
1.750	2.812	.250	18012 5066	HP	FKM
1.750	2.812	.250	18012 5066 304	HP	FKM
1.750	2.812	.250	18012 5066 316	HP	FKM
1.750	2.875	.313	0502 LDN 563 01750 313 VN	LDN	PTFE
1.750	2.875	.313	1750-2875-313ETBN	TB	NBR
1.750	2.875	.375	18036 H1L5	LUP	NBR
1.750	2.875	.375	18036 H1L5 PTFE	LUP	N/P
1.750	2.875	.375	18036 H5L16	LUP	FKM
1.750	2.875	.437	16371 H1L5	LUP	NBR
1.750	2.875	.437	16371 H5L16	LUP	FKM
1.750	2.875	.469	9947 H1L5	LUP	NBR
1.750	2.875	.500	0175 6942	SPLIT	NBR
1.750	2.875	.656	18189 H1L5	LDS	NBR
1.750	3.000	.313	0502 LDN 625 01750 313 VN	LDN	PTFE
1.750	3.000	.313	9076 H1L5	LPD	NBR
1.750	3.000	.375	1750-3000-375ETBN	TB	NBR
1.750	3.000	.375	8887 H1L5	LUP	NBR
1.750	3.000	.375	8887 H5L16	LUP	FKM
1.750	3.000	.625	15410 5066	HP	FKM
1.750	3.000	.625	15410 5066 304	HP	FKM
1.750	3.000	.625	15410 5066 316	HP	FKM
1.750	3.000	.625	15410 5066 EPDM	HP	EPDM
1.750	3.063	.438	11241 H1L5	LPD	NBR
1.750	3.063	.438	11241 H5L16	LPD	FKM
1.750	3.063	.438	0175 9302	SPLIT	NBR
1.750	3.125	.375	9021 H1L5	LPD	NBR
1.750	3.150	.375	20439 H1L5	LUP	NBR
1.750	3.187	.500	0175 17457	SPLIT	NBR
1.750	3.187	.500	0175 17457 V	SPLIT	FKM
1.750	3.189	.313	0502 LDN 720 01750 313 VN	LDN	PTFE
1.750	3.189	.313	1750-3189-313ETBN	TB	NBR
1.750	3.189	.500	8461 H1L5	LUP	NBR
1.750	3.250	.625	18312 ALLL5	MISC	NBR
1.750	3.266	.375	12940 H1L5	OLSS	NBR
1.750	3.347	.250	60018 H1L5	LDS	NBR
1.750	3.625	.500	10112 H1L5	LPD	NBR
1.750	5.500	1.250	16813 H1L5	SSW	NBR
1.751	2.188	.187	TN 2188-1214	TN	N/P
1.753	2.563	.438	11812 H1L5	LPDW	NBR
1.753	3.000	.406	11815 H1L5	SSW	NBR
1.754	2.442	.375	TMAL 2442-2422	TMAL	PTFE
1.760	2.411	.344	6234 H1L5	LA	NBR
1.760	2.411	.344	6234 H5L16	LA	FKM
1.769	2.594	.393	19578 H1L5	RUP	NBR
1.770	2.120	.180	19693 H1L70	SPCL	NBR
1.770	2.834	.375	5985 H1L2160	LA	EPDM
1.770	2.834	.375	5985 H1L5	LA	NBR
1.770	2.834	.375	5985 H1L5 PTFE	LA	N/P
1.770	2.834	.375	5985 H5L16	LA	FKM
1.771	2.500	.297	6576 H1L7	SDS	NBR
1.771	2.834	.393	13066 H1L5	LPD	NBR
1.771	2.834	.393	13066 H1L70	LPD	NBR
1.771	3.937	.500	9393 H1L5	LUP	NBR
1.771	3.937	.500	9393 H5L16	LUP	FKM
1.378	1.771	.276	19894 H1L5	SS	NBR
1.772	2.362	.276	15339 H1L5	LPD	NBR
1.772	2.362	.276	15339 H5L16	LPD	FKM
1.772	2.375	.438	18404 H1L5	LUPW	NBR

See Section 4 for seal type description. For High Misalignment sizes, see Page B-86. For FlexiSeal Listings, see Pages B-93 and B-97.

03/03/06



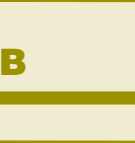

Shaft Dia.	Bore Dia.	Seal Width	Parker Part Number	Seal Type	Material
1.772	2.402	.354	14469 H1L7	P	NBR
1.772	2.441	.394	17392 H1L5	LUP	NBR
1.772	2.500	.219	10733 414	DS	CR
1.772	2.559	.315	30036 H5L89	LUP	FKM
1.772	2.622	.500	11499 H1L5	LUP	NBR
1.772	2.622	.500	11499 H1L5 PTFE	LUP	N/P
1.772	2.622	.500	11499 H1L2160	LUP	EPDM
1.772	2.622	.500	20401 H5MX5489	LUP	FKM
1.772	2.677	.394	15265 H1L5	LPD	NBR
1.772	2.750	.500	6226 H1L5	LA	NBR
1.772	2.953	.472	18375 H1L5	LUP	NBR
1.773	3.345	.438	10589 H1L5	LPD	NBR
1.778	2.622	.500	TMAS 2622-3227	TMAS	PTFE
1.781	2.500	.375	12678 H1L5	LPD	NBR
1.781	2.500	.375	12678 H1L5 PTFE	LPD	N/P
1.782	2.407	.250	0178 9858	SPLIT	NBR
1.782	2.532	.375	0178 3879	SPLIT	NBR
1.785	2.285	.250	6199 H1L5	LPD	NBR
1.785	2.285	.250	6199 H5MX5489	LPD	FKM
1.801	2.500	.250	70001 H1L5	TSS	NBR
1.810	1.575	.270	19702 H1L20	LUP	XNBR
1.810	2.310	.250	18988 H1L5	P	NBR
1.812	2.500	.375	5628 H1L5	LPD	NBR
1.812	2.500	.375	5628 H1L7	LPD	NBR
1.812	2.500	.375	5628 H5L16	LPD	FKM
1.812	2.625	.375	9168 H1L5	LUP	NBR
1.812	2.625	.375	9168 H5L16	LUP	FKM
1.812	2.625	.438	6112 H1L5	R	NBR
1.812	2.750	.375	TMAS 2750-2430	TMAS	PTFE
1.813	2.375	.250	0181 16227	SPLIT	NBR
1.813	2.437	.313	0181 4435	SPLIT	NBR
1.813	2.437	.313	0502 LDN 312 01813 313 VN	LDN	PTFE
1.813	2.437	.313	1813-2437-313ETBN	TB	NBR
1.813	2.500	.344	16382 5066	HP	FKM
1.813	2.500	.344	16382 5066 304	HP	FKM
1.813	2.500	.344	16382 5066 316	HP	FKM
1.813	2.563	.375	9584 H1L5	RPD	NBR
1.813	2.563	.375	9584 H1L5 PTFE	RPD	N/P
1.813	2.563	.375	0181 3879	SPLIT	NBR
1.813	2.563	.375	0181 3879 V	SPLIT	FKM
1.813	2.623	.313	0502 LDN 405 01813 313 VN	LDN	PTFE
1.813	2.623	.313	1813-2623-313ETBN	TB	NBR
1.813	2.625	.500	15020 H1L5	LPD	NBR
1.813	2.625	.500	15020 H5MX5489	LPD	FKM
1.813	2.750	.500	5630 H1L5	LUP	NBR
1.813	2.750	.500	5630 H5L16	LUP	FKM
1.813	2.750	.469	0181 4274	SPLIT	NBR
1.813	2.813	.500	0181 9668	SPLIT	NBR
1.813	2.818	.688	6047 H1L5	R	NBR
1.813	2.875	.313	0502 LDN 531 01813 313 VN	LDN	PTFE
1.813	2.875	.313	1813-2875-313ETBN	TB	NBR
1.813	2.875	.438	0181 3697	SPLIT	NBR
1.813	2.875	.500	13922 H1L5	LDS	NBR
1.813	2.875	.500	13922 H1L70	LDS	NBR
1.813	2.875	.500	13922 H5L16	LDS	FKM
1.813	3.000	.500	5355 H1L5	LPD	NBR
1.813	3.188	.438	5988 H1L5	LA	NBR
1.820	2.438	.250	10317 H1L5	LUP	NBR
1.820	2.438	.250	10317 H1L7	LUP	NBR
1.820	2.438	.250	10317 H5L16	LUP	FKM
1.820	2.438	.250	10317 H5MX5489	LUP	FKM
1.831	2.188	.328	18553 ALLL5	P	NBR
1.831	2.188	.328	18553 ALLL7	P	NBR
1.844	2.594	.375	0184 3879	SPLIT	NBR
1.844	2.631	.394	0184 15191	SPLIT	NBR
1.844	2.875	.469	16338 5066	HP	FKM

Shaft Dia.	Bore Dia.	Seal Width	Parker Part Number	Seal Type	Material
1.844	2.875	.469	16338 5066 304	HP	FKM
1.844	2.875	.469	16338 5066 316	HP	FKM
1.844	2.875	.469	8510 H1L5	LUP	NBR
1.848	2.745	.375	10799 H1L7	SS	NBR
1.870	2.687	.375	5893 H1L5	B	NBR
1.870	2.815	.437	4904 H1L5	B	NBR
1.872	2.372	.250	0184 13524	SPLIT	NBR
1.875	2.250	.187	TN 2250-1212	TN	N/P
1.875	2.250	.188	15283 H1L7	SS	NBR
1.875	2.313	.156	13606 414	DS	CR
1.875	2.375	.250	11641 ALLL7	SS	NBR
1.875	2.375	.250	11641 H1L5 PTFE	SS	N/P
1.875	2.375	.250	11641 H1L7	SS	NBR
1.875	2.375	.250	11641 H3L3	SS	CR
1.875	2.375	.250	11641 H5L16	SS	FKM
1.875	2.375	.250	0187 13524	SPLIT	NBR
1.875	2.375	.250	0187 13524 V	SPLIT	FKM
1.875	2.375	.313	9366 H1L5	LUP	NBR
1.875	2.375	.313	9366 H1L5 PTFE	LUP	N/P
1.875	2.375	.313	9366 H5L16	LUP	FKM
1.875	2.375	.313	9366 H5L16 PTFE	LUP	F/P
1.875	2.375	.313	TMAL 2375-2016	TMAL	PTFE
1.875	2.438	.313	16514 H1L5	LUP	NBR
1.875	2.438	.313	16514 H1L5 PTFE	LUP	N/P
1.875	2.500	.250	13465 H1L7	SS	NBR
1.875	2.500	.250	0187 9858	SPLIT	NBR
1.875	2.500	.313	0502 LDN 313 01875 313 VN	LDN	PTFE
1.875	2.500	.313	1875-2500-313ETBN	TB	NBR
1.875	2.500	.375	12618 H1L7	P	NBR
1.875	2.500	.375	12618 H5L16	P	FKM
1.875	2.500	.375	18156 H1L5	RUP	NBR
1.875	2.500	.375	18156 H1L5 PTFE	RUP	N/P
1.875	2.500	.375	18156 H1L50	RUP	NBR
1.875	2.500	.375	18156 H5L16	RUP	FKM
1.875	2.500	.375	TMAL 2500-2420	TMAL	PTFE
1.875	2.502	.250	19730 H1L7	SS	NBR
1.875	2.502	.313	0502 LDN 314 01875 313 VN	LDN	PTFE
1.875	2.502	.313	1875-2502-313ETBN	TB	NBR
1.875	2.623	.313	0502 LDN 374 01875 313 VN	LDN	PTFE
1.875	2.623	.313	17793 H1L5	LUP	NBR
1.875	2.623	.313	17793 H1L5 PTFE	LUP	N/P
1.875	2.623	.313	17793 H5L16	LUP	FKM
1.875	2.623	.313	1875-2623-313ETBN	TB	NBR
1.875	2.625	.312	TMAL 2625-2024	TMAL	PTFE
1.875	2.625	.375	16092 5066	HP	FKM
1.875	2.625	.375	16092 5066 304	HP	FKM
1.875	2.625	.375	16092 5066 316	HP	FKM
1.875	2.625	.375	0187 3879	SPLIT	NBR
1.875	2.625	.375	0187 7131	SPLIT	NBR
1.875	2.625	.375	TMAL 2625-2424	TMAL	PTFE
1.875	2.625	.375	TN 2625-2424	TN	N/P
1.875	2.625	.375	TNV 2625-2424	TN	N/P
1.875	2.625	.438	9550 H1L5	LUP	NBR
1.875	2.625	.438	9550 H1L5 PTFE	LUP	N/P
1.875	2.625	.438	9550 H5L16	LUP	FKM
1.875	2.625	.438	TMAL 2625-2824	TMAL	PTFE
1.875	2.625	.500	14905 H1L5	LDS	NBR
1.875	2.625	.500	14905 H5L16	LDS	FKM
1.875	2.625	.500	5826 H1L20	LPD	XNBR
1.875	2.625	.500	5826 H1L5	LPD	NBR
1.875	2.625	.500	5826 H5L16	LPD	FKM
1.875	2.627	.375	19063 H1L5	H	NBR
1.875	2.627	.375	19063 H1L7	H	NBR
1.875	2.627	.375	19063 H5L16	H	FKM
1.875	2.627	.750	15627 H1L5	P	NBR
1.875	2.627	.750	15627 H1L7	P	NBR

See Section 4 for seal type description. For High Misalignment sizes, see Page B-86. For FlexiSeal Listings, see Pages B-93 and B-97.

03/03/06



Rotary Lip Seal Inch Sizes

1.875 to 1.938

B

Shaft Dia.	Bore Dia.	Seal Width	Parker Part Number	Seal Type	Material
1.875	2.686	.375	1875-2686-375ETCN	TC	NBR
1.875	2.688	.375	0187 7081	SPLIT	NBR
1.875	2.750	.188	15528 414	DS	CR
1.875	2.750	.250	10872 H1L5	RPD	NBR
1.875	2.750	.313	0502 LDN 438 01875 313 VN	LDN	PTFE
1.875	2.750	.313	1875-2750-313ETBN	TB	NBR
1.875	2.750	.375	16396 5066	HP	FKM
1.875	2.750	.375	16396 5066 304	HP	FKM
1.875	2.750	.375	16396 5066 316	HP	FKM
1.875	2.750	.375	18151 5066	HP	FKM
1.875	2.750	.375	18151 5066 304	HP	FKM
1.875	2.750	.375	18151 5066 316	HP	FKM
1.875	2.750	.375	9189 H1L5	LPD	NBR
1.875	2.750	.375	9189 H1L20	LPD	XNBR
1.875	2.750	.375	9189 H5L16	LPD	FKM
1.875	2.750	.375	16615 H1L5	SSW	NBR
1.875	2.750	.438	12528 H1L5	LPD	NBR
1.875	2.750	.438	9560 H1L5	RPD	NBR
1.875	2.750	.438	9560 H5L16	RPD	FKM
1.875	2.750	.438	0187 4162	SPLIT	NBR
1.875	2.750	.500	5750 H1L5	LPD	NBR
1.875	2.750	.500	5750 H5L16	LPD	FKM
1.875	2.785	.250	5576 H1L7	SS	NBR
1.875	2.785	.250	5576 H5L16	SS	FKM
1.875	2.813	.313	0502 LDN 469 01875 313 VN	LDN	PTFE
1.875	2.813	.469	0187 4274	SPLIT	NBR
1.875	2.813	.500	1875-2813-500ETBN	TB	NBR
1.875	2.813	.500	0187 5828	SPLIT	NBR
1.875	2.871	.500	0187 11634	SPLIT	NBR
1.875	2.875	.313	0502 LDN 500 01875 313 VN	LDN	PTFE
1.875	2.875	.313	12407 H1L5	LPD	NBR
1.875	2.875	.313	12407 H1L5 PTFE	LPD	N/P
1.875	2.875	.313	12407 H5L16	LPD	FKM
1.875	2.875	.313	1875-2875-313ETBN	TB	NBR
1.875	2.875	.438	6727 H1L5	LA	NBR
1.875	2.875	.438	0187 3625	SPLIT	NBR
1.875	2.875	.438	9694 H1L7	SS	NBR
1.875	2.875	.438	9694 H5L16	SS	FKM
1.875	2.875	.500	6936 H1L5	LUP	NBR
1.875	2.875	.500	6936 H5L16	LUP	FKM
1.875	2.875	.500	0187 9668	SPLIT	NBR
1.875	2.875	.531	5773 H1L5	LA	NBR
1.875	2.875	.625	17670 H1L5	LDS	NBR
1.875	2.890	.500	14844 ALLL16	SPCL	FKM
1.875	2.891	.500	15025 H1L2160	LDS	EPDM
1.875	2.891	.500	15025 H1L5	LDS	NBR
1.875	2.891	.500	15025 H1L7	LDS	NBR
1.875	2.933	.438	0187 13328	SPLIT	NBR
1.875	2.997	.313	0502 LDN 561 01875 313 VN	LDN	PTFE
1.875	2.997	.313	1875-2997-313ETBN	TB	NBR
1.875	3.000	.250	1875-3000-250EVBN	VB	NBR
1.875	3.000	.312	1875-3000-312ETBN	TB	NBR
1.875	3.000	.313	0502 LDN 563 01875 313 VN	LDN	PTFE
1.875	3.000	.375	16012 H1L5	LUP	NBR
1.875	3.000	.375	16012 H5L16	LUP	FKM
1.875	3.000	.375	16012 H5L16 PTF	LUP	F/P
1.875	3.000	.406	16048 H1L5	SSW	NBR
1.875	3.000	.406	16048 H5L16	SSW	FKM
1.875	3.000	.500	8989 H1L5	LUP	NBR
1.875	3.000	.500	8989 H1L5 PTFE	LUP	N/P
1.875	3.000	.500	8989 H5L16	LUP	FKM
1.875	3.000	.500	0187 6942	SPLIT	NBR
1.875	3.061	.313	0502 LDN 593 01875 313 VN	LDN	PTFE
1.875	3.061	.313	1875-3061-313ETBN	TB	NBR
1.875	3.125	.375	9190 H1L5	LPD	NBR
1.875	3.125	.375	9190 H5MX5489	LPD	FKM

Shaft Dia.	Bore Dia.	Seal Width	Parker Part Number	Seal Type	Material
1.875	3.188	.438	9302 H1L5	RPD	NBR
1.875	3.313	.375	5989 H1L5	LA	NBR
1.875	3.313	.500	17457 H1L5	RUP	NBR
1.875	3.313	.500	17457 H5L16	RUP	FKM
1.875	3.438	.500	TMAL 3438-3250	TMAL	PTFE
1.875	3.500	.500	8992 H1L5	LPD	NBR
1.875	3.543	.375	10189 H1L5	LPD	NBR
1.875	3.543	.375	10189 H5MX5489	LPD	FKM
1.875	6.000	.625	17795 H1L5	SSW	NBR
1.890	2.835	.449	20777 5202	MP	FKM
1.890	5.000	.669	19184 H1L5	LUP	NBR
1.906	2.657	.375	0190 7131	SPLIT	NBR
1.906	2.906	.438	0190 3625	SPLIT	NBR
1.906	2.907	.500	0190 18759	SPLIT	NBR
1.920	2.441	.320	18823 H1L5	LUP	NBR
1.920	2.441	.320	18823 H1L5 PTFE	LUP	N/P
1.920	2.441	.320	18823 H5L16PTFE	LUP	F/P
1.930	3.544	.250	60010 H1L5	LDS	NBR
1.936	2.686	.375	16984 H1L5	LUP	NBR
1.936	2.686	.375	16984 H5L16	LUP	FKM
1.937	2.437	.250	TMAS 2437-1616	TMAS	PTFE
1.937	2.875	.437	TMAL 2875-2830	TMAL	PTFE
1.937	3.000	.250	TMAS 3000-1634	TMAS	PTFE
1.938	2.430	.250	0193 13524	SPLIT	NBR
1.938	2.437	.250	1938-2437-250ETBN	TB	NBR
1.938	2.437	.313	0502 LDN 250 01938 313 VN	LDN	PTFE
1.938	2.438	.188	6278 414	DS	CR
1.938	2.471	.267	15978 5066	HP	FKM
1.938	2.471	.267	15978 5066 304	HP	FKM
1.938	2.471	.267	15978 5066 316	HP	FKM
1.938	2.500	.375	15113 H1L5	LPDW	NBR
1.938	2.500	.375	3556 H1L2160	LUP	EPDM
1.938	2.500	.375	3556 H1L5	LUP	NBR
1.938	2.500	.375	3556 H1L5 PTFE	LUP	N/P
1.938	2.500	.375	3556 H5L16	LUP	FKM
1.938	2.502	.281	1938-2502-281EVBN	VB	NBR
1.938	2.502	.313	0502 LDN 282 01938 313 VN	LDN	PTFE
1.938	2.502	.375	1938-2502-375ETBN	TB	NBR
1.938	2.563	.250	0193 9697	SPLIT	NBR
1.938	2.563	.250	0193 9697 V	SPLIT	FKM
1.938	2.563	.313	4435 H1L5	RPD	NBR
1.938	2.563	.313	4435 H5L16	RPD	FKM
1.938	2.623	.313	0502 LDN 343 01938 313 VN	LDN	PTFE
1.938	2.623	.313	1938-2623-313ETBN	TB	NBR
1.938	2.625	.313	8443 H1L5	LPD	NBR
1.938	2.625	.313	8443 H5L16	LPD	FKM
1.938	2.625	.375	5277 H1L5	LUP	NBR
1.938	2.625	.375	5277 H1L5 PTFE	LUP	N/P
1.938	2.625	.375	5277 H5L16	LUP	FKM
1.938	2.686	.313	0502 LDN 374 01938 313 VN	LDN	PTFE
1.938	2.686	.313	1938-2686-313ETBN	TB	NBR
1.938	2.688	.375	0193 7131	SPLIT	NBR
1.938	2.688	.375	0193 7131 V	SPLIT	FKM
1.938	2.688	.438	3716 H1L5	RUP	NBR
1.938	2.688	.500	13579 H1L5	LDS	NBR
1.938	2.750	.313	0502 LDN 406 01938 313 VN	LDN	PTFE
1.938	2.750	.313	1938-2750-313ETBN	TB	NBR
1.938	2.750	.375	16496 5066	HP	FKM
1.938	2.750	.375	16496 5066 304	HP	FKM
1.938	2.750	.375	16496 5066 316	HP	FKM
1.938	2.750	.375	16496 5066 MISC	HP	FKM
1.938	2.750	.375	9596 H1L5	LPD	NBR
1.938	2.750	.375	9596 H5L16	LPD	FKM
1.938	2.750	.375	9596 H5L16 PTFE	LPD	F/P
1.938	2.750	.375	0193 7081	SPLIT	NBR
1.938	2.750	.375	0193 7081 PTFE	SPLIT	NBR

See Section 4 for seal type description. For High Misalignment sizes, see Page B-86. For FlexiSeal Listings, see Pages B-93 and B-97.

03/03/06



Shaft Dia.	Bore Dia.	Seal Width	Parker Part Number	Seal Type	Material
1.938	2.813	.438	0193 3837	SPLIT	NBR
1.938	2.875	.313	0502 LDN 469 01938 313 VN	LDN	PTFE
1.938	2.875	.313	1938-2875-313ETBN	TB	NBR
1.938	2.875	.375	16719 H1L5	LDS	NBR
1.938	2.875	.438	8874 H1L5	LUP	NBR
1.938	2.875	.438	8874 H1L5 PTFE	LUP	N/P
1.938	2.875	.438	8874 H5L16	LUP	FKM
1.938	2.875	.438	8874 H5L16 PTFE	LUP	F/P
1.938	2.875	.438	19905 H5L16	SS	FKM
1.938	2.875	.469	0193 4274	SPLIT	NBR
1.938	2.875	.469	0193 4274 V	SPLIT	FKM
1.938	2.875	.500	5828 H1L5	RUP	NBR
1.938	2.875	.500	5828 H5L16	RUP	FKM
1.938	2.879	.438	9626 H1L5	LPD	NBR
1.938	2.937	.500	0193 11634	SPLIT	NBR
1.938	2.938	.438	0193 3625	SPLIT	NBR
1.938	2.938	.438	0193 3625 V	SPLIT	FKM
1.938	2.964	.500	19005 H1L5	LDS	NBR
1.938	2.996	.438	11535 H1L5	LPD	NBR
1.938	2.996	.438	11535 H5L16	LPD	FKM
1.938	3.000	.313	0502 LDN 531 01938 313 VN	LDN	PTFE
1.938	3.000	.313	1938-3000-313ETBN	TB	NBR
1.938	3.000	.438	3697 H1L5	RUP	FKM
1.938	3.000	.438	3697 H5L16	RUP	NBR
1.938	3.000	.500	5737 H1L5	LUP	NBR
1.938	3.000	.500	5737 H5L16	LUP	FKM
1.938	3.003	.438	7347 H1L5	LPD	NBR
1.938	3.003	.438	18405 H1L5	LUPW	NBR
1.938	3.003	.438	18405 H5MX5489	LUPW	FKM
1.938	3.005	.500	0193 6956	SPLIT	NBR
1.938	3.061	.313	0502 LDN 562 01938 313 VN	LDN	PTFE
1.938	3.061	.313	1938-3061-313ETBN	TB	NBR
1.938	3.063	.500	10527 H1L5	LPD	NBR
1.938	3.125	.313	0502 LDN 594 01938 313 VN	LDN	PTFE
1.938	3.125	.500	1938-3125-500ETBN	TB	NBR
1.938	3.125	.500	5276 H1L5	LA	NBR
1.938	3.125	.500	5276 H5L16	LA	FKM
1.938	3.188	.188	9090 414	DS	CR
1.938	3.188	.468	TMAL 3188-3040	TMAL	PTFE
1.938	3.188	.469	10949 H1L3	LPD	CR
1.938	3.188	.469	10949 H1L5	LPD	NBR
1.938	3.188	.469	10949 H5L16	LPD	FKM
1.938	3.188	.500	9396 H1L5	LPD	NBR
1.938	3.189	.438	5128 H1L5	LPD	NBR
1.938	3.189	.500	5465 H1L5	RUP	NBR
1.938	3.250	.406	17343 H1L5	SSW	NBR
1.938	3.250	.406	17343 H5L16	SSW	FKM
1.938	3.500	.500	8816 H1L5	LPD	NBR
1.955	2.497	.235	13545 H1L5	SDS	NBR
1.960	3.375	.469	11582 H1L5	LPD	NBR
1.960	3.375	.469	5215 H1L5	R	NBR
1.962	3.188	.469	3898 H1L5	LPD	NBR
1.963	3.544	.500	12526 H1L5	LPD	NBR
1.963	3.544	.500	12526 H1L5 PTFE	LPD	N/P
1.963	3.544	.500	12526 H1L7	LPD	NBR
1.969	2.442	.354	16020 H1L7	P	NBR
1.969	2.559	.315	15296 H1L5	LPD	NBR
1.969	2.559	.315	15296 H5L16	LPD	FKM
1.969	2.598	.354	13161 H1L7	P	NBR
1.969	2.623	.313	0502 LDN 327 01969 313 VN	LDN	PTFE
1.969	2.623	.313	1969-2623-313ETBN	TB	NBR
1.969	2.688	.375	9397 H1L21	LUP	EPDM
1.969	2.688	.375	9397 H1L5	LUP	NBR
1.969	2.688	.375	9397 H1L70	LUP	NBR
1.969	2.688	.375	9397 H5L16	LUP	FKM
1.969	2.690	.300	19376 H1L5	P	NBR

Shaft Dia.	Bore Dia.	Seal Width	Parker Part Number	Seal Type	Material
1.969	2.719	.375	0196 7131	SPLIT	NBR
1.969	2.750	.438	11837 H1L5	LPD	NBR
1.969	2.756	.394	15191 H1L21	RPD	EPDM
1.969	2.756	.394	15191 H1L5	RPD	NBR
1.969	2.834	.393	10738 H1L5	LPD	NBR
1.969	2.834	.393	10738 H5L16	LPD	FKM
1.969	2.875	.438	6666 H1L5	LA	NBR
1.969	2.875	.500	8864 H1L5	LPD	NBR
1.969	2.969	.438	0196 3625	SPLIT	NBR
1.969	3.036	.500	0196 6956	SPLIT	NBR
1.969	3.125	.500	16972 H1L2160	LPD	EPDM
1.969	3.125	.500	16972 H1L5	LPD	NBR
1.969	3.125	.500	16972 H1L5 PTFE	LPD	N/P
1.969	3.125	.500	16972 H5L16	LPD	FKM
1.969	3.125	.500	16972 H5L89	LPD	FKM
1.969	3.149	.500	10015 H1L5	LUP	NBR
1.969	3.189	.500	5466 H1L5	LPD	NBR
1.969	3.189	.500	5466 H5/MX5489	LPD	FKM
1.969	3.189	.500	5466 H5L16	LPD	FKM
1.969	4.331	.313	12279 H1L5	LPD	NBR
1.969	4.331	.500	15438 H1L7	SS	NBR
1.970	3.150	.394	14197 H1L5	SSW	NBR
1.970	3.150	.394	14197 H5L16	SSW	FKM
1.973	2.875	.375	60022 H1L5	LDS	NBR
1.975	2.975	.438	0197 3625	SPLIT	NBR
1.980	2.730	.375	0198 7131	SPLIT	NBR
1.984	2.500	.375	13335 H1L7	SS	NBR
1.990	4.382	.187	19737 H1L5	SS	NBR
1.994	2.932	.250	10726 414	DS	CR
1.994	2.932	.250	10726 MX5489	DS	FKM
1.994	2.994	.438	0199 3625	SPLIT	NBR
1.998	2.495	.375	13071 ALLL7	P	NBR
1.999	2.687	.343	TMAL 2687-2222	TMAL	PTFE
2.000	2.313	.156	18327 ALLL7	P	NBR
2.000	2.375	.187	NVM81167	VM	NBR
2.000	2.379	.328	12320 ALLL16	P	FKM
2.000	2.379	.328	12320 ALLL7	P	NBR
2.000	2.500	.328	18309 H1L7	P	NBR
2.000	2.502	.250	13524 H1L5	RUP	NBR
2.000	2.502	.250	13524 H1L5 PTFE	RUP	N/P
2.000	2.502	.250	13524 H5L89	RUP	FKM
2.000	2.502	.250	2000-2502-250ETCN	TC	NBR
2.000	2.502	.250	2000-2502-250EVBN	VB	NBR
2.000	2.525	.281	19224 H1L5	LDS	NBR
2.000	2.531	.250	13893 ALLL7	P	NBR
2.000	2.531	.250	13893 ALLL16	P	FKM
2.000	2.560	.156	11225 H1L7	SS	NBR
2.000	2.560	.156	11225 H5L16	SS	FKM
2.000	2.563	.250	16227 H1L5	RUP	NBR
2.000	2.623	.313	0502 LDN 312 02000 313 VN	LDN	PTFE
2.000	2.623	.313	2000-2623-313ETBN	TB	NBR
2.000	2.625	.250	13571 H1L5	LPD	NBR
2.000	2.625	.250	13571 H5L16	LPD	FKM
2.000	2.625	.250	9858 H1L5	RPD	NBR
2.000	2.625	.250	0200 9697	SPLIT	NBR
2.000	2.625	.250	19960 H1L7	SS	NBR
2.000	2.625	.313	11855 H1L5	LDS	NBR
2.000	2.625	.313	11855 H5L16	LDS	FKM
2.000	2.625	.313	9736 H1L5	LPD	NBR
2.000	2.625	.313	9736 H5L16	LPD	FKM
2.000	2.625	.313	5844 H1L5	RPD	NBR
2.000	2.625	.313	11970 H1L7	SS	NBR
2.000	2.625	.313	11970 H5L16	SS	FKM
2.000	2.625	.375	11174 H1L7	SS	NBR
2.000	2.625	.500	17688 H1L5	LDS	NBR
2.000	2.686	.375	10207 H1L5	LUP	NBR



See Section 4 for seal type description. For High Misalignment sizes, see Page B-86. For FlexiSeal Listings, see Pages B-93 and B-97.

03/03/06



Rotary Lip Seal Inch Sizes

2.000 to 2.000

B

Shaft Dia.	Bore Dia.	Seal Width	Parker Part Number	Seal Type	Material
2.000	2.686	.375	10207 H1L5 PTFE	LUP	N/P
2.000	2.686	.375	10207 H5L16	LUP	FKM
2.000	2.686	.375	3975 H1L5	B	NBR
2.000	2.688	.344	15216 5066	HP	FKM
2.000	2.688	.344	15216 5066 304	HP	FKM
2.000	2.688	.344	15216 5066 316	HP	FKM
2.000	2.688	.375	TMAL 2688-2422	TMAL	PTFE
2.000	2.688	.500	13587 H1L5	LPD	NBR
2.000	2.715	.437	15558 H1L5	LUP	NBR
2.000	2.715	.437	15558 H5L16	LUP	FKM
2.000	2.716	.375	9818 H1L5	RUP	NBR
2.000	2.716	.375	9818 H5L16	RUP	FKM
2.000	2.750	.250	10755 H1L5	LPD	NBR
2.000	2.750	.250	10755 H1L5 PTFE	LPD	N/P
2.000	2.750	.250	10755 H5L16	LPD	FKM
2.000	2.750	.313	0502 LDN 375 02000 313 VN	LDN	PTFE
2.000	2.750	.313	2000-2750-313ETBN	TB	NBR
2.000	2.750	.313	TMAL 2750-2024	TMAL	PTFE
2.000	2.750	.375	13847 H1L5	LPDW	NBR
2.000	2.750	.375	3879 H1L21	RPD	EPDM
2.000	2.750	.375	3879 H1L5	RPD	NBR
2.000	2.750	.375	3879 H1L5 PTFE	RPD	N/P
2.000	2.750	.375	3879 H5L16	RPD	FKM
2.000	2.750	.375	0200 7131	SPLIT	NBR
2.000	2.750	.375	0200 7131 V	SPLIT	FKM
2.000	2.750	.375	10834 H1L7	SS	NBR
2.000	2.750	.375	10834 H1L7 PTFE	SS	N/P
2.000	2.750	.438	9120 H1L5	LUP	NBR
2.000	2.750	.438	9120 H1L5 PTFE	LUP	N/P
2.000	2.750	.438	9120 H1L70	LUP	NBR
2.000	2.750	.438	9120 H5L16	LUP	FKM
2.000	2.750	.500	11551 H1L5	LUP	NBR
2.000	2.750	.500	11551 H1L5 PTFE	LUP	N/P
2.000	2.750	.500	11551 H1L70	LUP	NBR
2.000	2.750	.500	11551 H5L16	LUP	FKM
2.000	2.763	.250	20413 H1L5	LUP	NBR
2.000	2.783	.375	8817 H1L5	LUP	NBR
2.000	2.783	.375	8817 H5L16	LUP	FKM
2.000	2.783	.375	8817 H5MX5489	LUP	FKM
2.000	2.813	.375	0200 7081	SPLIT	NBR
2.000	2.873	.375	NSEC81037	SEC	NBR
2.000	2.875	.313	0502 LDN 438 02000 313 VN	LDN	PTFE
2.000	2.875	.313	2000-2875-313ETBN	TB	NBR
2.000	2.875	.375	14154 H1L5	LPD	NBR
2.000	2.875	.375	14154 H5L16	LPD	FKM
2.000	2.875	.375	14154 H5L16 PTF	LPD	F/P
2.000	2.875	.438	4162 H1L5	RUP	NBR
2.000	2.875	.438	4162 H5L16	RUP	FKM
2.000	2.875	.437	TMAL 2875-2828	TMAL	PTFE
2.000	2.875	.438	15800 5066	HP	FKM
2.000	2.875	.438	15800 5066 304	HP	FKM
2.000	2.875	.438	15800 5066 316	HP	FKM
2.000	2.875	.500	9653 H1L5	LPD	NBR
2.000	2.875	.500	9653 H5MX5489	LPD	FKM
2.000	2.938	.375	19352 H1L5	SSW	NBR
2.000	2.938	.375	19352 H5L89	SSW	FKM
2.000	2.969	.282	6000 H1L5	SS	NBR
2.000	2.997	.438	9652 H1L5	LUP	NBR
2.000	2.997	.438	9652 H1L50	LUP	NBR
2.000	2.997	.438	9652 H5L16	LUP	FKM
2.000	3.000	.250	10757 H1L3	LPD	CR
2.000	3.000	.250	10757 H1L5	LPD	NBR
2.000	3.000	.250	10757 H5L16	LPD	FKM
2.000	3.000	.250	TMAL 3000-1632	TMAL	PTFE
2.000	3.000	.313	0502 LDN 500 02000 313 VN	LDN	PTFE
2.000	3.000	.313	2000-3000-313ETBN	TB	NBR

Shaft Dia.	Bore Dia.	Seal Width	Parker Part Number	Seal Type	Material
2.000	3.000	.375	17681 H1L5	LPD	NBR
2.000	3.000	.375	17681 H5L16	LPD	FKM
2.000	3.000	.375	11018 H1L5	LUP	NBR
2.000	3.000	.375	11018 H1L5 PTFE	LUP	N/P
2.000	3.000	.375	11018 H5L16	LUP	FKM
2.000	3.000	.375	11018 H5MX5489	LUP	FKM
2.000	3.000	.375	0200 4868	SPLIT	NBR
2.000	3.000	.375	0200 4868 V	SPLIT	FKM
2.000	3.000	.375	TMAL 3000-2432	TMAL	PTFE
2.000	3.000	.438	0200 3625	SPLIT	NBR
2.000	3.000	.438	0200 3625 H1L21	SPLIT	EPDM
2.000	3.000	.438	0200 3625 H1L7	SPLIT	NBR
2.000	3.000	.438	0200 3625 V	SPLIT	FKM
2.000	3.000	.469	0200 13681	SPLIT	NBR
2.000	3.000	.500	16200 H1L7	H	NBR
2.000	3.000	.500	15218 5066	HP	FKM
2.000	3.000	.500	15218 5066 304	HP	FKM
2.000	3.000	.500	15218 5066 316	HP	FKM
2.000	3.000	.500	14783 H1L5	LPDW	NBR
2.000	3.000	.500	19681 H5MX5489	LUP	FKM
2.000	3.000	.500	9043 H1L5	LUP	NBR
2.000	3.000	.500	9043 H1L5 PTFE	LUP	N/P
2.000	3.000	.500	9043 H1L7 PTFE	LUP	N/P
2.000	3.000	.500	9043 H1L70	LUP	NBR
2.000	3.000	.500	9043 H5L16	LUP	FKM
2.000	3.000	.500	9668 H1L5	RPD	NBR
2.000	3.000	.500	9668 H5L16	RPD	FKM
2.000	3.000	.500	0200 18759	SPLIT	NBR
2.000	3.000	.500	0200 9598	SPLIT	NBR
2.000	3.000	.500	10618 H1L7	SS	NBR
2.000	3.000	.500	TMAL 3000-3232	TMAL	PTFE
2.000	3.000	.625	15729 H1L5	LDS	NBR
2.000	3.000	.625	15729 H5L16	LDS	FKM
2.000	3.058	.438	13328 H1L5	RPD	NBR
2.000	3.058	.438	13328 H5L16	RPD	FKM
2.000	3.061	.250	2000-3061-250EVBN	VB	NBR
2.000	3.062	.313	0502 LDN 531 02000 313 VN	LDN	PTFE
2.000	3.062	.375	2000-3062-375ETBN	TB	NBR
2.000	3.062	.438	7361 H1L5	LPD	NBR
2.000	3.062	.438	7361 H1L5 PTFE	LPD	N/P
2.000	3.062	.438	7361 H5L89	LPD	FKM
2.000	3.067	.500	0200 6956	SPLIT	NBR
2.000	3.110	.500	17604 H1L5	LDS	NBR
2.000	3.110	.500	17604 H5MX5489	LDS	FKM
2.000	3.125	.312	2000-3125-312ETBN	TB	NBR
2.000	3.125	.313	0502 LDN 563 02000 313 VN	LDN	PTFE
2.000	3.125	.375	9020 H1L5	LPD	NBR
2.000	3.125	.375	9020 H1L5 PTFE	LPD	N/P
2.000	3.125	.375	9020 H5L16	LPD	FKM
2.000	3.125	.375	19940	MP	FKM
2.000	3.125	.375	19940 L20	PC	XNBR
2.000	3.125	.500	6942 H1L5	RUP	NBR
2.000	3.125	.500	6942 H5L16	RUP	FKM
2.000	3.188	.438	11240 H1L5	LPD	NBR
2.000	3.188	.438	11240 H5L16	LPD	FKM
2.000	3.189	.500	15706 H1L5	LUP	NBR
2.000	3.250	.406	11983 H1L5	SSW	NBR
2.000	3.250	.406	11983 H1L7	SSW	NBR
2.000	3.250	.500	2470 H1L5	LPD	NBR
2.000	3.250	.500	2470 H5L16	LPD	FKM
2.000	3.250	.500	0200 3930	SPLIT	NBR
2.000	3.250	.625	TMAS 3250-4040	TMAS	PTFE
2.000	3.251	.313	0502 LDN 626 02000 313 VN	LDN	PTFE
2.000	3.251	.438	2000-3251-438ETBN	TB	NBR
2.000	3.313	.469	9344 H1L7	SS	NBR
2.000	3.319	.469	17074 H1L5	R	NBR

See Section 4 for seal type description. For High Misalignment sizes, see Page B-86. For FlexiSeal Listings, see Pages B-93 and B-97.

03/03/06



B

Shaft Dia.	Bore Dia.	Seal Width	Parker Part Number	Seal Type	Material
2.000	3.319	.469	4504 H1L5	R	NBR
2.000	3.350	.500	5144 H1L5	LUP	NBR
2.000	3.371	.468	8858 H1L5	LPD	NBR
2.000	3.375	.375	8489 H1L5	LUP	NBR
2.000	3.375	.375	8489 H1L5 PTFE	LUP	N/P
2.000	3.375	.470	5892 H1L5	LPD	NBR
2.000	3.375	.500	10791 H1L5	LPD	NBR
2.000	3.375	.500	9068 H1L7	SS	NBR
2.000	3.500	.688	19348 412	DS	CR
2.000	3.561	.500	12164 H1L7	SS	NBR
2.000	3.623	.250	2000-3623-250EVBN	VB	NBR
2.000	3.672	.500	19044 H1L5	OLSS	NBR
2.000	3.750	.500	0200 11149 V	SPLIT	FKM
2.000	3.750	.500	0200 19682 V	SPLIT	FKM
2.000	4.000	.500	12638 H1L5	LPD	NBR
2.010	3.125	.335	19644 5202	MP	FKM
2.027	2.626	.250	15882 H1L5	LUP	NBR
2.027	2.626	.250	15882 H1L5 PTFE	LUP	N/P
2.027	2.626	.250	15882 H5/MX5489	LUP	FKM
2.027	2.959	.281	13133 ALLL5	LPDW	NBR
2.031	3.063	.375	5221 H1L5	LA	NBR
2.032	3.032	.375	0203 4868	SPLIT	NBR
2.047	3.346	.500	9933 H1L7	SS	NBR
2.059	2.825	.375	17091 H1L5	RUP	NBR
2.062	2.688	.375	16478 H1L5	LDS	NBR
2.062	2.688	.375	16478 H5L16	LDS	FKM
2.062	2.875	.375	12163 H1L5	LPD	NBR
2.062	3.000	.375	12163 H5/MX5489	LPD	FKM
2.062	3.000	.375	12163 H5L16	LPD	FKM
2.062	3.000	.375	TMAL 2875-2426	TMAL	PTFE
2.062	3.000	.469	10860 H1L5	LUP	NBR
2.062	3.000	.469	10860 H5L16	LUP	FKM
2.062	3.000	.469	4274 H1L5	RUP	NBR
2.062	3.000	.469	4274 H5L16	RUP	FKM
2.062	3.000	.500	5022 H1L5	LUP	NBR
2.062	3.000	.500	5022 H5L16	LUP	FKM
2.063	2.688	.250	9697 H1L5	RUP	NBR
2.063	2.688	.250	9697 H5L16	RUP	FKM
2.063	2.783	.375	7029 H1L5	LUP	NBR
2.063	2.813	.375	12150 H1L5	RPD	NBR
2.063	2.813	.438	0206 14922	SPLIT	NBR
2.063	2.875	.313	0502 LDN 406 02063 313 VN	LDN	PTFE
2.063	2.875	.375	0206 6532	SPLIT	NBR
2.063	2.875	.375	2063-2875-375ETBN	TB	NBR
2.063	2.875	.469	16533 H1L5	LUP	NBR
2.063	2.875	.469	16533 H5L16	LUP	FKM
2.063	3.000	.313	0502 LDN 469 02063 313 VN	LDN	PTFE
2.063	3.000	.375	2063-3000-375ETBN	TB	NBR
2.063	3.000	.438	0206 3838	SPLIT	NBR
2.063	3.063	.375	12882 H1L5	LDS	NBR
2.063	3.063	.375	10474 H1L5	LUP	NBR
2.063	3.063	.375	10474 H5L16	LUP	FKM
2.063	3.063	.375	0206 4868	SPLIT	NBR
2.063	3.063	.500	17054 H1L5	LUP	NBR
2.063	3.063	.500	11634 H1L5	RPD	NBR
2.063	3.063	.500	0206 9598	SPLIT	NBR
2.063	3.125	.438	5571 H1L5	LPD	NBR
2.063	3.125	.438	5571 H5L16	LPD	FKM
2.063	3.125	.500	5145 H1L5	LUP	NBR
2.063	3.125	.500	5145 H5L16	LUP	FKM
2.063	3.149	.438	9885 H1L5	LPD	NBR
2.063	3.188	.375	0206 5865	SPLIT	NBR
2.063	3.188	.438	10701 H1L5	LPD	NBR
2.063	3.188	.500	11149 H1L5	RPD	NBR
2.063	3.188	.500	11149 H5L16	RPD	FKM
2.063	3.247	.500	0206 6207	SPLIT	NBR

Shaft Dia.	Bore Dia.	Seal Width	Parker Part Number	Seal Type	Material
2.063	3.250	.500	11014 H1L5	LPD	NBR
2.075	3.188	.375	8435 H1L5	LPD	NBR
2.090	3.150	.250	20585 H1L5	LUP	NBR
2.094	2.844	.438	0209 14922	SPLIT	NBR
2.094	3.094	.375	0209 4868	SPLIT	NBR
2.094	3.193	.500	0209 10918	SPLIT	NBR
2.100	3.100	.375	0210 4868	SPLIT	NBR
2.120	2.388	.440	18319 472	SPCL	472
2.120	3.000	.438	3837 H1L5	B	NBR
2.120	3.250	.438	16468 H1L5	LDS	NBR
2.120	3.250	.438	16468 H5L16	LDS	FKM
2.122	2.594	.250	5036 414	DS	CR
2.125	2.500	.250	16821 H1L7	SS	NBR
2.125	2.500	.313	6944 H1L7	SS	NBR
2.125	2.625	.328	12317 ALLL7	P	NBR
2.125	2.750	.250	0212 9954	SPLIT	NBR
2.125	2.750	.313	0502 LDN 313 02125 313 VN	LDN	PTFE
2.125	2.750	.375	17794 H1L5	LUP	NBR
2.125	2.750	.375	17794 H1L5 PTFE	LUP	N/P
2.125	2.750	.375	17794 H5L16	LUP	FKM
2.125	2.750	.500	2125-2750-500ETBN	TB	NBR
2.125	2.813	.375	0212 9819	SPLIT	NBR
2.125	2.833	.438	4587 H1L5	LUP	NBR
2.125	2.875	.250	2125-2875-250EVBN	VB	NBR
2.125	2.875	.313	0502 LDN 375 02125 313 VN	LDN	PTFE
2.125	2.875	.370	19629 H1L5 PTFE	SS	N/P
2.125	2.875	.375	16443 5066	HP	FKM
2.125	2.875	.375	16443 5066 304	HP	FKM
2.125	2.875	.375	16443 5066 316	HP	FKM
2.125	2.875	.375	10259 H1L5	LUP	NBR
2.125	2.875	.375	10259 H1L5 PTFE	LUP	N/P
2.125	2.875	.375	10259 H5L16	LUP	FKM
2.125	2.875	.375	10259 H5L16PTFE	LUP	F/P
2.125	2.875	.375	7131 H1L5	RUP	NBR
2.125	2.875	.375	7131 H1L5 PTFE	RUP	N/P
2.125	2.875	.375	7131 H5L16	RUP	FKM
2.125	2.875	.375	7131 H5L89	RUP	FKM
2.125	2.875	.375	0212 18216	SPLIT	NBR
2.125	2.875	.375	TMAL 2875-2424	TMAL	PTFE
2.125	2.875	.438	6113 H1L5	LPD	NBR
2.125	2.875	.438	6113 H1L7 PTFE	LPD	N/P
2.125	2.875	.438	6113 H5L16	LPD	FKM
2.125	2.875	.438	6113 H5L16 PTFE	LPD	F/P
2.125	2.875	.438	0212 14922	SPLIT	NBR
2.125	2.875	.438	0212 14922 V	SPLIT	FKM
2.125	2.875	.438	2125-2875-438ETBN	TB	NBR
2.125	2.879	.375	14002 H1L5	LDS	NBR
2.125	2.879	.375	14002 H5L16	LDS	FKM
2.125	2.938	.375	7081 H1L5	RUP	NBR
2.125	2.938	.375	7081 H1L5 PTFE	RUP	N/P
2.125	2.938	.375	7081 H5L16	RUP	FKM
2.125	2.938	.375	0212 6532	SPLIT	NBR
2.125	2.996	.495	18908 5066	HP	FKM
2.125	2.996	.495	18908 5066 304	HP	FKM
2.125	2.997	.313	0502 LDN 436 02125 313 VN	LDN	PTFE
2.125	2.997	.375	2125-2997-375ETBN	TB	NBR
2.125	3.000	.250	2125-3000-250EVBN	VB	NBR
2.125	3.000	.313	0502 LDN 438 02125 313 VN	LDN	PTFE
2.125	3.000	.375	2125-3000-375ETBN	TB	NBR
2.125	3.000	.500	15393 H1L5	LDS	NBR
2.125	3.000	.500	10756 H1L5	LUP	NBR
2.125	3.000	.500	10756 H1L5 PTFE	LUP	N/P
2.125	3.000	.500	10756 H5L16	LUP	FKM
2.125	3.061	.313	0502 LDN 468 02125 313 VN	LDN	PTFE
2.125	3.061	.500	2125-3061-500ETBN	TB	NBR
2.125	3.062	.500	11522 H1L5	LPD	NBR

See Section 4 for seal type description. For High Misalignment sizes, see Page B-86. For FlexiSeal Listings, see Pages B-93 and B-97.

03/03/06



Rotary Lip Seal Inch Sizes

2.125 to 2.188

B

Shaft Dia.	Bore Dia.	Seal Width	Parker Part Number	Seal Type	Material
2.125	3.062	.500	0212 12450	SPLIT	NBR
2.125	3.063	.438	0212 3838	SPLIT	NBR
2.125	3.063	.500	6081 H1L7	SS	NBR
2.125	3.125	.313	0502 LDN 500 02125 313 VN	LDN	PTFE
2.125	3.125	.375	0212 8486	SPLIT	NBR
2.125	3.125	.375	TMAL 3125-2432	TMAL	PTFE
2.125	3.125	.437	TMAL 3125-2832	TMAL	PTFE
2.125	3.125	.438	3625 H1L5	RUP	NBR
2.125	3.125	.438	3625 H1L7	RUP	NBR
2.125	3.125	.438	3625 H1L2160	RUP	EPDM
2.125	3.125	.438	3625 H5L16	RUP	FKM
2.125	3.125	.438	0212 8486	SPLIT	NBR
2.125	3.125	.438	0212 8486 V	SPLIT	FKM
2.125	3.125	.438	0212 9074	SPLIT	NBR
2.125	3.125	.438	2125-3125-438ETBN	TB	NBR
2.125	3.125	.500	0212 9598	SPLIT	NBR
2.125	3.125	.500	0212 9598 V	SPLIT	FKM
2.125	3.125	.500	18759 H1L5	RUP	NBR
2.125	3.125	.500	16452 H1L5	LUP	NBR
2.125	3.125	.500	16452 H1L5 PTFE	LUP	N/P
2.125	3.125	.500	16452 H5L16	LUP	FKM
2.125	3.125	.500	8462 H1L5	LPD	NBR
2.125	3.125	.500	8462 H5L89	LPD	FKM
2.125	3.125	.500	14619 H1L5	LDS	NBR
2.125	3.125	.500	14619 H5L16	LDS	FKM
2.125	3.130	.250	6292 H1L5	SS	NBR
2.125	3.158	.375	13840 H1L5	LPD	NBR
2.125	3.158	.375	13840 H5L16	LPD	FKM
2.125	3.188	.438	17178 H1L5	LDS	NBR
2.125	3.188	.438	17178 H5L16	LDS	FKM
2.125	3.189	.250	2125-3189-250EVBN	VB	NBR
2.125	3.189	.313	0502 LDN 532 02125 313 VN	LDN	PTFE
2.125	3.189	.375	2125-3189-375ETBN	TB	NBR
2.125	3.189	.500	9922 H1L5	LUPW	NBR
2.125	3.192	.500	6956 H1L5	RPD	NBR
2.125	3.192	.500	6956 H5L16	RPD	FKM
2.125	3.225	.500	0212 10918	SPLIT	NBR
2.125	3.250	.188	11798 414	DS	CR
2.125	3.250	.375	10253 H1L5	LUP	NBR
2.125	3.250	.375	10253 H5L16	LUP	FKM
2.125	3.250	.375	0212 5865	SPLIT	NBR
2.125	3.250	.375	0212 5865 V	SPLIT	FKM
2.125	3.250	.438	60025 H1L5	LDS	NBR
2.125	3.250	.500	17311 H1L5	OLLUP	NBR
2.125	3.251	.313	0502 LDN 563 02125 313 VN	LDN	PTFE
2.125	3.251	.438	2125-3251-438ETBN	TB	NBR
2.125	3.371	.469	10911 H1L5	LPD	NBR
2.125	3.371	.469	10911 H5L16	LPD	FKM
2.125	3.375	.500	15392 H1L5	LDS	NBR
2.125	3.375	.500	0212 3930	SPLIT	NBR
2.125	3.500	.438	11981 H1L5	LPD	NBR
2.125	3.500	.438	11981 H5L16	LPD	FKM
2.125	3.500	.500	16901 H1L5	SSW	NBR
2.125	3.545	.438	6941 H1L5	LA	NBR
2.125	3.545	.438	6941 H5MX5489	LA	FKM
2.125	3.545	.500	17952 H1L5	LUP	NBR
2.125	3.545	.500	17952 H5MX5489	LUP	FKM
2.125	3.545	.500	0212 11319	SPLIT	NBR
2.125	3.750	.438	17917 H1L5	LDS	NBR
2.126	3.251	.437	TMAL 3251-2836	TMAL	PTFE
2.130	3.500	.281	10645 414	DS	CR
2.140	3.500	.500	10158 H1L5	LPDW	NBR
2.156	3.156	.438	0215 8486	SPLIT	NBR
2.156	3.156	.500	0215 9598	SPLIT	NBR
2.156	3.256	.500	0215 10918	SPLIT	NBR
2.158	3.189	.500	18406 H1L5	LUP	NBR

Shaft Dia.	Bore Dia.	Seal Width	Parker Part Number	Seal Type	Material
2.158	3.189	.500	18406 H5L16	LUP	FKM
2.160	3.543	.433	20655 H5L16	LUP	FKM
2.161	3.250	.406	16189 H1L5	SSW	NBR
2.164	3.938	.375	13284 H1L5	LDS	NBR
2.164	3.938	.375	13284 H5L16	LDS	FKM
2.165	2.638	.354	15427 H1L7	P	NBR
2.165	2.638	.354	15427 H5L16	P	FKM
2.165	2.736	.315	20656 H5L16	LDS	FKM
2.165	2.756	.315	14043 H1L5	LPD	NBR
2.165	2.756	.315	14043 H5L16	LPD	FKM
2.165	2.790	.250	0216 9954	SPLIT	NBR
2.165	2.835	.375	5792 H1L5	LA	NBR
2.165	2.835	.375	5792 H5L16	LA	FKM
2.165	2.953	.433	13656 H1L7	P	NBR
2.165	3.149	.433	30034 H5L89	LUP	FKM
2.166	3.125	.250	10730 414	DS	CR
2.166	3.190	.469	11569 H1L5	LPD	NBR
2.180	2.875	.375	20699 H5L16	OLLUP	FKM
2.187	3.250	.437	TMAL 3250-2834	TMAL	PTFE
2.188	2.688	.375	11994 H1L7	P	NBR
2.188	2.688	.375	11994 ALL7	P	NBR
2.188	2.750	.250	0218 9819	SPLIT	NBR
2.188	2.813	.250	0218 9954	SPLIT	NBR
2.188	2.813	.250	0218 9954 V	SPLIT	FKM
2.188	2.823	.142	17387 H1L5	SS	NBR
2.188	2.823	.142	17387 H5L16	SS	FKM
2.188	2.875	.375	17182 5066	HP	FKM
2.188	2.875	.375	17182 5066 304	HP	FKM
2.188	2.938	.375	17182 5066 316	HP	FKM
2.188	2.938	.375	17182 SPEC	SPC	NO PTFE
2.188	2.938	.375	14970 H1L5	LPD	NBR
2.188	2.938	.375	14970 H5L16	LPD	FKM
2.188	2.938	.375	0218 18216	SPLIT	NBR
2.188	2.938	.500	0218 17628	SPLIT	NBR
2.188	2.992	.375	0218 9648	SPLIT	NBR
2.188	3.000	.250	13980 H1L5	OLLPD	NBR
2.188	3.000	.313	0502 LDN 406 02188 313 VN	LDN	PTFE
2.188	3.000	.375	2188-3000-375ETBN	TB	NBR
2.188	3.000	.375	0218 6532	SPLIT	NBR
2.188	3.000	.375	0218 6532 V	SPLIT	FKM
2.188	3.000	.500	16697 5066	HP	FKM
2.188	3.000	.500	16697 5066 304	HP	FKM
2.188	3.000	.500	16697 5066 316	HP	FKM
2.188	3.000	.500	4976 H1L5	LUP	NBR
2.188	3.000	.500	4976 H5L16	LUP	FKM
2.188	3.063	.500	11515 H1L5	LPD	NBR
2.188	3.063	.500	1218 9708	SPLIT	NBR
2.188	3.125	.375	12364 H1L5	LPD	NBR
2.188	3.125	.375	12364 H1L5 PTFE	LPD	N/P
2.188	3.125	.375	12364 H5L16	LPD	FKM
2.188	3.125	.438	0218 3838	SPLIT	NBR
2.188	3.156	.500	0218 19069	SPLIT	NBR
2.188	3.187	.375	0218 4868	SPLIT	NBR
2.188	3.187	.500	0218 9598	SPLIT	NBR
2.188	3.188	.375	18426 H1L5	LUP	NBR
2.188	3.188	.375	18426 H5L16	LUP	FKM
2.188	3.188	.438	0218 8486	SPLIT	NBR
2.188	3.188	.453	TMAL 3188-2932	TMAL	PTFE
2.188	3.188	.468	TMAL 3188-3032	TMAL	PTFE
2.188	3.189	.469	11055 H1L3	LUP	CR
2.188	3.189	.469	11055 H1L5	LUP	NBR
2.188	3.189	.469	11055 H5L16	LUP	FKM
2.188	3.189	.469	0218 13681	SPLIT	NBR
2.188	3.250	.250	9085 414	DS	CR
2.188	3.250	.438	9398 H1L5	LUP	NBR
2.188	3.250	.438	9398 H1L5 PTFE	LUP	N/P

See Section 4 for seal type description. For High Misalignment sizes, see Page B-86. For FlexiSeal Listings, see Pages B-93 and B-97.

03/03/06



B

Shaft Dia.	Bore Dia.	Seal Width	Parker Part Number	Seal Type	Material
2.188	3.250	.438	9398 H5MX5489	LUP	FKM
2.188	3.250	.500	8873 H1L5	LPD	NBR
2.188	3.250	.500	8873 H5L16	LPD	FKM
2.188	3.350	.469	11696 H1L5	LPD	NBR
2.188	3.350	.469	11696 H5L16	LPD	FKM
2.188	3.372	.500	5632 H1L5	LPD	NBR
2.188	3.372	.500	5632 H5L16	LPD	FKM
2.188	3.500	.500	16469 H1L5	LDS	NBR
2.188	3.500	.500	16469 H5L16	LDS	FKM
2.188	3.500	.500	19146 H1L5	LDS	NBR
2.188	3.500	.500	0218 15200	SPLIT	NBR
2.189	3.189	.468	TMAL 3189-3032	TMAL	PTFE
2.218	3.034	.375	0221 9648	SPLIT	NBR
2.219	3.094	.500	0221 9708	SPLIT	NBR
2.219	3.219	.500	0221 9597	SPLIT	NBR
2.219	3.250	.375	16349 H1L5	LUP	NBR
2.219	3.938	.375	13677 H1L5	LDS	NBR
2.219	3.938	.500	60014 H1L5	LDS	NBR
2.230	2.855	.250	0223 9954	SPLIT	NBR
2.232	3.543	.375	4049 H1L5	LUP	NBR
2.232	3.543	.375	4049 H5L16	LUP	FKM
2.239	3.545	.313	17573 H1L5	EL	NBR
2.239	3.545	.344	17514 H1L5	LUPW	NBR
2.240	3.166	.500	0224 19069	SPLIT	NBR
2.240	3.240	.500	0224 9597	SPLIT	NBR
2.248	3.000	.375	NCS81153	SPC	NBR
2.248	3.000	.375	13690 ALLL16	P	FKM
2.248	3.000	.375	13690 ALLL7	P	NBR
2.250	2.750	.313	16232 H1L5	LUPW	NBR
2.250	2.753	.313	15177 H1L7	H	NBR
2.250	2.842	.438	11547 ALLL7	P	NBR
2.250	2.875	.250	19331	MP	FKM
2.250	2.875	.250	0225 9954	SPLIT	NBR
2.250	2.875	.250	2250-2875-250EVBN	VB	NBR
2.250	2.875	.313	16399 5066	HP	FKM
2.250	2.875	.313	16399 5066 304	HP	FKM
2.250	2.875	.313	16399 5066 316	HP	FKM
2.250	2.875	.313	0502 LDN 313 02250 313 VN	LDN	PTFE
2.250	2.875	.313	12246 H1L5	LPDW	NBR
2.250	2.875	.313	10251 H1L5	LUP	NBR
2.250	2.875	.313	10251 H1L5 PTFE	LUP	N/P
2.250	2.875	.313	10251 H5L16	LUP	FKM
2.250	2.875	.313	TMAL 2875-2020	TMAL	PTFE
2.250	2.875	.313	TMAS 2875-2020	TMAS	PTFE
2.250	2.875	.375	2250-2875-375ETBN	TB	NBR
2.250	2.906	.375	0225 9819	SPLIT	NBR
2.250	3.000	.313	0502 LDN 375 02250 313 VN	LDN	PTFE
2.250	3.000	.375	15455 5066	HP	FKM
2.250	3.000	.375	15455 5066 304	HP	FKM
2.250	3.000	.375	15455 5066 316	HP	FKM
2.250	3.000	.375	10289 H1L5	LUP	NBR
2.250	3.000	.375	10289 H1L5 PTFE	LUP	N/P
2.250	3.000	.375	10289 H1L7	LUP	NBR
2.250	3.000	.375	10289 H5L16	LUP	FKM
2.250	3.000	.375	10289 H5L16 PTF	LUP	F/P
2.250	3.000	.375	10289 H5MX5489	LUP	FKM
2.250	3.000	.375	19867 H1L7	SS	NBR
2.250	3.000	.375	19867 H1L7 PTFE	SS	N/P
2.250	3.000	.375	19867 H5L89	SS	FKM
2.250	3.000	.375	2250-3000-375ETBN	TB	NBR
2.250	3.000	.375	60000 H1L5	LUP	NBR
2.250	3.000	.375	TMAL 3000-2424	TMAL	PTFE
2.250	3.000	.438	14922 H1L5	RPD	NBR
2.250	3.000	.438	14922 H5L16	RPD	FKM
2.250	3.000	.500	12842 H1L5	LDS	NBR
2.250	3.000	.500	12842 H5L16	LDS	FKM

Shaft Dia.	Bore Dia.	Seal Width	Parker Part Number	Seal Type	Material
2.250	3.000	.500	10432 H1L5	LUP	NBR
2.250	3.000	.500	10432 H5L16	LUP	FKM
2.250	3.000	.500	0225 17628	SPLIT	NBR
2.250	3.061	.250	2250-3061-250EVBN	VB	NBR
2.250	3.062	.438	9218 H1L5	LPD	NBR
2.250	3.062	.438	9218 H1L2160	LPD	EPDM
2.250	3.062	.438	9218 H5L16	LPD	FKM
2.250	3.063	.438	6013 H1L7	SS	NBR
2.250	3.063	.438	6013 H1L70	SS	NBR
2.250	3.063	.438	6013 H5L16	SS	FKM
2.250	3.067	.375	0225 9648	SPLIT	NBR
2.250	3.067	.375	0225 9648 V	SPLIT	FKM
2.250	3.125	.438	19485 H1L5	LDS	NBR
2.250	3.125	.438	19485 H5L16	LDS	FKM
2.250	3.125	.438	40027 H5L16	LDS	FKM
2.250	3.125	.438	8493 H1L5	LPD	NBR
2.250	3.125	.438	8493 H1L5 PTFE	LPD	N/P
2.250	3.125	.438	8493 H5L16	LPD	FKM
2.250	3.125	.438	19827	MP	FKM
2.250	3.125	.500	8494 H1L5	LPD	NBR
2.250	3.125	.500	8494 H1L70	LPD	NBR
2.250	3.125	.500	8494 H5L16	LPD	FKM
2.250	3.125	.500	0225 10034	SPLIT	NBR
2.250	3.188	.250	19475 H1L5	LUP	NBR
2.250	3.188	.437	10513 H1L5	LUP	NBR
2.250	3.188	.437	10513 H5L16	LUP	FKM
2.250	3.188	.500	0225 12450	SPLIT	NBR
2.250	3.194	.469	6296 H1L5	LA	NBR
2.250	3.250	.375	6336 H1L5	LUP	NBR
2.250	3.250	.375	6336 H1L5 PTFE	LUP	N/P
2.250	3.250	.375	6336 H5L16	LUP	FKM
2.250	3.250	.375	6336 H5MX5489	LUP	FKM
2.250	3.250	.375	4868 H1L5	RUP	NBR
2.250	3.250	.375	4868 H5L16	RUP	FKM
2.250	3.250	.375	TMAL 3250-2432	TMAL	PTFE
2.250	3.250	.375	TMAS 3250-2432	TMAS	PTFE
2.250	3.250	.438	0225 8486	SPLIT	NBR
2.250	3.250	.438	0225 8486 V	SPLIT	FKM
2.250	3.250	.500	16202 H1L5	H	NBR
2.250	3.250	.500	16202 H1L5 PTFE	H	N/P
2.250	3.250	.500	16202 H1L2160	H	EPDM
2.250	3.250	.500	16202 H5L16	H	FKM
2.250	3.250	.500	14372 H1L5	LDS	NBR
2.250	3.250	.500	14372 H5L89	LDS	FKM
2.250	3.250	.500	13316 H1L5	LDS	NBR
2.250	3.250	.500	17994 H1L5	LPD	NBR
2.250	3.250	.500	17994 H1L70	LPD	NBR
2.250	3.250	.500	10418 H1L5	LUP	NBR
2.250	3.250	.500	10418 H1L5 PTFE	LUP	N/P
2.250	3.250	.500	10418 H1L50	LUP	NBR
2.250	3.250	.500	10418 H1L70	LUP	NBR
2.250	3.250	.500	10418 H5L16	LUP	FKM
2.250	3.250	.500	17113 ALLL5	LUP	NBR
2.250	3.250	.500	17113 ALLL16	LUP	FKM
2.250	3.250	.500	17307 H1L5	LUPW	NBR
2.250	3.250	.500	17307 H1L5 PTFE	LUPW	N/P
2.250	3.250	.500	17307 H5L16	LUPW	FKM
2.250	3.250	.500	12048 H1L5	P	NBR
2.250	3.250	.500	12048 H1L7	P	NBR
2.250	3.250	.500	17707 H1L7	P	NBR
2.250	3.250	.750	10623 H1L7	SS	NBR
2.250	3.250	.750	10623 H1L7 PTFE	SS	N/P
2.250	3.250	.750	0225 9597	SPLIT	NBR
2.250	3.250	.750	0225 9597 V	SPLIT	FKM
2.250	3.251	.250	2250-3251-250EVBN	VB	NBR
2.250	3.251	.313	0502 LDN 501 02250 313 VN	LDN	PTFE

See Section 4 for seal type description. For High Misalignment sizes, see Page B-86. For FlexiSeal Listings, see Pages B-93 and B-97.

03/03/06



B

Shaft Dia.	Bore Dia.	Seal Width	Parker Part Number	Seal Type	Material
2.250	3.251	.375	2250-3251-375ETBN	TB	NBR
2.250	3.251	.469	13681 H1L5	RPD	NBR
2.250	3.251	.469	13681 H5L16	RPD	FKM
2.250	3.350	.469	16268 H1L7	SS	NBR
2.250	3.350	.469	16268 H5L16	SS	FKM
2.250	3.350	.500	10982 H1L5	LPD	NBR
2.250	3.350	.500	10982 H5L16	LPD	FKM
2.250	3.350	.500	0225 10918	SPLIT	NBR
2.250	3.351	.469	10301 H1L5	LUP	NBR
2.250	3.351	.469	10301 H5L16	LUP	FKM
2.250	3.353	.375	14095 H1L5	LPD	NBR
2.250	3.353	.375	14095 H5L16	LPD	FKM
2.250	3.356	.375	0225 14918	SPLIT	NBR
2.250	3.371	.375	2250-3371-375EVBN	VB	NBR
2.250	3.375	.375	TMAL 3375-2436	TMAL	PTFE
2.250	3.375	.468	0225 14921	SPLIT	NBR
2.250	3.375	.500	9686 H1L5	LPD	NBR
2.250	3.375	.625	17671 H1L5	LDS	NBR
2.250	3.434	.500	6207 H1L5	RUP	NBR
2.250	3.481	.500	19421 H1L5	LDS	NBR
2.250	3.500	.250	TMAL 3500-1640	TMAL	PTFE
2.250	3.500	.313	0502 LDN 625 02250 313 VN	LDN	PTFE
2.250	3.500	.375	11776 414	DS	CR
2.250	3.500	.375	15889 H1L5	LUP	NBR
2.250	3.500	.375	15889 H1L2160	LUP	EPDM
2.250	3.500	.375	15889 H5L16	LUP	FKM
2.250	3.500	.375	2250-3500-375ETBN	TB	NBR
2.250	3.500	.437	40028 H1L5	LDS	NBR
2.250	3.500	.437	40028 H5L16	LDS	FKM
2.250	3.500	.500	8991 H1L5	LPD	NBR
2.250	3.500	.500	8991 H1L7	LPD	NBR
2.250	3.500	.500	8991 H5L16	LPD	FKM
2.250	3.500	.500	3930 H1L5	RUP	NBR
2.250	3.625	.469	0225 9655	SPLIT	NBR
2.250	3.625	.500	17845 H1L5	OLLUP	NBR
2.250	3.625	.500	19359 H1L5	RUP	NBR
2.250	3.625	.500	19359 H5L16	RUP	FKM
2.250	3.670	.500	11319 H1L5	RPD	NBR
2.250	3.750	.500	18412 H1L5	LDS	NBR
2.250	3.750	.500	9715 H1L5	LUP	NBR
2.250	3.750	.500	9715 H5MX5489	LUP	FKM
2.250	4.000	.500	8495 H1L3 PTFE	LPD	CR/PTFE
2.250	4.000	.500	8495 H1L5	LPD	NBR
2.250	4.000	.500	8495 H1L7 PTFE	LPD	N/P
2.250	4.000	.500	8495 H5L16	LPD	FKM
2.250	4.000	.500	8495 H5MX5489	LPD	FKM
2.250	4.000	.500	11992 H1L5	SSW	NBR
2.250	4.000	.500	11992 H5L16	SSW	FKM
2.250	4.003	.500	10959 H1L5	LPD	NBR
2.250	4.250	.350	20534 H1L5	SSW	NBR
2.250	4.500	.468	0225 5474	SPLIT	NBR
2.250	5.119	.500	17257 H1L5	LUP	NBR
2.280	3.280	.500	0228 9597	SPLIT	NBR
2.281	3.062	.312	TN 3062-2025	TN	N/P
2.281	3.062	.312	TNV 3062-2025	TN	N/P
2.281	2.875	.297	12121 H1L5	LPD	NBR
2.281	3.347	.250	6878 H1L5	LPD	NBR
2.281	3.347	.375	18285 H1L5	LUP	NBR
2.282	3.098	.375	0228 9648	SPLIT	NBR
2.283	2.835	.315	19701 H1L5 PTFE	SS	N/P
2.283	2.953	.394	18810 H1L5	LUP	NBR
2.285	3.150	.394	18801 5066	HP	FKM
2.293	2.998	.188	12973 H1L7	SS	NBR
2.293	3.000	.344	70003 H1L5	TSS	NBR
2.300	3.000	.355	13662 H1L5	OLSS	NBR
2.306	3.219	.320	12477 ALLL5	LPDW	NBR

Shaft Dia.	Bore Dia.	Seal Width	Parker Part Number	Seal Type	Material
2.307	2.899	.273	15615 H1L5	LPD	NBR
2.307	2.899	.337	10318 H1L5	LPD	NBR
2.307	3.544	.313	15462 H1L5	LDS	NBR
2.308	2.813	.250	5037 414	DS	CR
2.309	3.125	.375	0230 9648 V	SPLIT	FKM
2.309	3.493	.500	15922 H1L5	RPD	NBR
2.312	3.000	.375	15065 H1L5	LUP	NBR
2.312	3.000	.375	15065 H1L7	LUP	NBR
2.312	3.125	.375	17817 H1L5	LUP	NBR
2.312	3.125	.500	16535 H1L5	LUP	NBR
2.312	3.125	.500	16535 H1L7	LUP	NBR
2.312	3.125	.500	16535 H5L16	LUP	FKM
2.312	3.125	.500	6048 H1L5	RUP	NBR
2.312	3.250	.438	9149 H1L5	LUP	NBR
2.312	3.250	.438	9149 H5L16	LUP	FKM
2.312	3.250	.438	3838 H1L5	RUP	NBR
2.312	3.250	.438	3838 H5L16	RUP	FKM
2.312	3.250	.438	TMAL 3250-2830	TMAL	PTFE
2.313	2.937	.250	0231 9698	SPLIT	NBR
2.313	3.000	.250	2313-3000-250EVBN	VB	NBR
2.313	3.000	.375	16498 5066	HP	FKM
2.313	3.000	.375	16498 5066 304	HP	FKM
2.313	3.000	.375	16498 5066 316	HP	FKM
2.313	3.000	.375	16498 5066 SPEC	SPC	NO PTFE
2.313	3.000	.375	0231 16905	SPLIT	NBR
2.313	3.063	.375	15163 H1L5	LPDW	NBR
2.313	3.125	.313	0502 LDN 406 02313 313 VN	LDN	PTFE
2.313	3.125	.375	6532 H1L5	RUP	NBR
2.313	3.125	.375	6532 H5L16	RUP	FKM
2.313	3.125	.375	0231 9648	SPLIT	NBR
2.313	3.128	.375	0231 9648 V	SPLIT	FKM
2.313	3.128	.375	2313-3125-375ETBN	TB	NBR
2.313	3.156	.500	18537 H1L5	LUP	NBR
2.313	3.188	.375	0231 6060	SPLIT	NBR
2.313	3.188	.500	0231 10034	SPLIT	NBR
2.313	3.191	.438	4843 H1L5	LPD	NBR
2.313	3.250	.313	0502 LDN 469 02313 313 VN	LDN	PTFE
2.313	3.250	.375	2313-3250-375ETBN	TB	NBR
2.313	3.250	.500	0231 12450	SPLIT	NBR
2.313	3.313	.438	0231 9074	SPLIT	NBR
2.313	3.313	.500	9598 H1L5	RPD	NBR
2.313	3.313	.500	9598 H5L16	RPD	FKM
2.313	3.313	.500	0231 9597	SPLIT	NBR
2.313	3.372	.500	0231 12596	SPLIT	NBR
2.313	3.375	.313	0502 LDN 531 02313 313 VN	LDN	PTFE
2.313	3.375	.375	2313-3375-375ETBN	TB	NBR
2.313	3.412	.500	10918 H1L5	RPD	NBR
2.313	3.418	.375	5865 H1L5	R	NBR
2.313	3.438	.375	5865 H5L89	R	FKM
2.313	3.438	.375	0231 14918	SPLIT	NBR
2.313	3.500	.313	0502 LDN 594 02313 313 VN	LDN	PTFE
2.313	3.500	.313	2313-3500-313ETBN	TB	NBR
2.313	3.625	.500	15200 H1L5	RPD	NBR
2.313	4.500	.500	19364 H1L5	LUP	NBR
2.313	5.118	.375	10499 H1L5	LPD	NBR
2.313	5.118	.500	10191 H1L5	LPD	NBR
2.330	3.250	.438	9453 H1L5	LPD	NBR
2.330	3.250	.438	9453 H5L16	LPD	FKM
2.330	3.252	.438	12498 H1L5	LPDW	NBR
2.330	3.625	.438	12501 H1L7	SSW	NBR
2.342	3.092	.375	18216 H1L5	RPD	NBR
2.344	3.032	.375	0234 16905	SPLIT	NBR
2.344	3.160	.375	0234 9648	SPLIT	NBR
2.344	3.160	.375	0234 9648 V	SPLIT	FKM
2.344	3.219	.375	0234 6060	SPLIT	NBR
2.344	3.219	.625	17070 H1L5	LUP	NBR

See Section 4 for seal type description. For High Misalignment sizes, see Page B-86. For FlexiSeal Listings, see Pages B-93 and B-97.

03/03/06



B

Shaft Dia.	Bore Dia.	Seal Width	Parker Part Number	Seal Type	Material
2.344	3.224	.500	0234 10034	SPLIT	NBR
2.344	3.250	.375	16783 H1L5	LDS	NBR
2.344	3.344	.438	0234 9074	SPLIT	NBR
2.344	3.469	.468	0234 14921	SPLIT	NBR
2.344	3.875	.500	9750 H1L5	LUP	NBR
2.344	4.594	.468	0234 5474	SPLIT	NBR
2.350	3.175	.375	0235 9648	SPLIT	NBR
2.350	3.228	.375	0235 6060	SPLIT	NBR
2.360	3.150	.433	13857 H1L7	P	NBR
2.360	3.313	.640	10458 H1L5	LPD	NBR
2.361	5.118	.375	13283 H1L5	LDS	NBR
2.362	2.835	.354	14712 H1L7	P	NBR
2.362	3.071	.394	18038 H1L5	LUP	NBR
2.362	3.149	.393	14643 H1L5	LPD	NBR
2.362	3.149	.393	14643 H1L5 PTFE	LPD	N/P
2.362	3.149	.393	14643 H5L16	LPD	FKM
2.362	3.149	.393	14643 H5L16PTFE	LPD	F/P
2.362	3.150	.433	14714 H1L7	P	NBR
2.362	3.150	.512	0236 18522 V	SPLIT	FKM
2.362	3.307	.512	18461 ALLL5	LUP	NBR
2.362	3.938	.512	15038 H1L5	SSW	NBR
2.362	4.331	.500	15440 H1L7	SS	NBR
2.363	3.127	.375	14617 H1L5	LPD	NBR
2.363	3.127	.375	14617 H5L16	LPD	FKM
2.363	3.287	.250	10729 414	DS	CR
2.363	3.349	.469	11453 H1L5	LUP	NBR
2.363	3.349	.469	11453 H5L16	LUP	FKM
2.370	3.000	.313	4534 H1L5	B	NBR
2.370	3.372	.500	14871 H1L5	LDSW	NBR
2.370	3.372	.500	14871 H5L89	LDSW	FKM
2.370	3.376	.218	19736 H1L5	SS	NBR
2.370	4.381	.437	19735 H1L5	SS	NBR
2.374	3.062	.375	TMAS 3062-2422	TMAS	PTFE
2.375	2.875	.313	5638 H1L7	SS	NBR
2.375	2.875	.313	5638 H5L16	SS	FKM
2.375	3.000	.250	13981 H1L5	OLSS	NBR
2.375	3.000	.250	13981 H1L5 PTFE	OLSS	N/P
2.375	3.000	.250	13981 H5L16	OLSS	FKM
2.375	3.000	.250	9954 H1L5	RPD	NBR
2.375	3.000	.250	9954 H5L16	RPD	FKM
2.375	3.000	.250	0237 9698	SPLIT	NBR
2.375	3.000	.250	2375-3000-250EVBN	VB	NBR
2.375	3.000	.313	0237 4374	SPLIT	NBR
2.375	3.000	.313	0237 4374 V	SPLIT	FKM
2.375	3.000	.313	0502 LDN 313 02375 313 VN	LDN	PTFE
2.375	3.000	.375	16807 5066	HP	FKM
2.375	3.063	.375	16807 5066 304	HP	FKM
2.375	3.063	.375	16807 5066 316	HP	FKM
2.375	3.125	.313	0502 LDN 375 02375 313 VN	LDN	PTFE
2.375	3.125	.375	9546 H1L5	LUP	NBR
2.375	3.125	.375	9546 H1L5 PTFE	LUP	N/P
2.375	3.125	.375	9546 H1L7	LUP	NBR
2.375	3.125	.375	9546 H5L16	LUP	FKM
2.375	3.125	.375	9546 H5L16 PTFE	LUP	N/P
2.375	3.125	.375	9819 H1L5	RPD	NBR
2.375	3.125	.375	0237 16905	SPLIT	NBR
2.375	3.125	.375	0237 3707	SPLIT	NBR
2.375	3.125	.375	2375-3000-375ETBN	TB	NBR
2.375	3.125	.438	0237 7339	SPLIT	NBR
2.375	3.125	.438	0237 7339 V	SPLIT	FKM
2.375	3.125	.438	2375-3125-438ETBN	TB	NBR
2.375	3.125	.500	17628 H1L5	RUP	NBR
2.375	3.125	.500	17628 H5L16	RUP	FKM
2.375	3.147	.386	10385 H1L5	LPD	NBR
2.375	3.147	.500	4690 H1L5	LPD	NBR
2.375	3.188	.438	6879 H1L5	LA	NBR

Shaft Dia.	Bore Dia.	Seal Width	Parker Part Number	Seal Type	Material
2.375	3.191	.375	0237 9648	SPLIT	NBR
2.375	3.250	.328	11875 H1L5	LPD	NBR
2.375	3.250	.328	11875 H1L5 PTFE	LPD	N/P
2.375	3.250	.328	11875 H1L70	LPD	H1L70
2.375	3.250	.328	11875 H5L16	LPD	FKM
2.375	3.250	.328	11875 H5L16 PTF	LPD	F/P
2.375	3.250	.375	19445 5066	HP	FKM
2.375	3.250	.375	0237 6060	SPLIT	NBR
2.375	3.250	.437	0237 9055	SPLIT	NBR
2.375	3.250	.437	0237 9055 V	SPLIT	FKM
2.375	3.250	.500	0237 10034	SPLIT	NBR
2.375	3.313	.469	17440 ALLL5	LUP	NBR
2.375	3.313	.469	17991 ALLL5	LUP	NBR
2.375	3.344	.500	19069 H1L5	RPD	NBR
2.375	3.350	.469	6071 H1L5	LUP	NBR
2.375	3.350	.469	6071 H5L16	LUP	FKM
2.375	3.350	.500	9144 H1L5	LPD	NBR
2.375	3.350	.500	9144 H1L5 PTFE	LPD	N/P
2.375	3.350	.500	9144 H5L16	LPD	FKM
2.375	3.355	.469	17699 5066	HP	FKM
2.375	3.355	.469	17699 5066 304	HP	FKM
2.375	3.355	.469	17699 5066 316	HP	FKM
2.375	3.357	.500	0237 11248	SPLIT	NBR
2.375	3.365	.469	16709 H1L5	LUP	NBR
2.375	3.371	.438	2375-3371-438ETBN	TB	NBR
2.375	3.375	.313	0502 LDN 500 02375 313 VN	LDN	PTFE
2.375	3.375	.438	8486 H1L5	RUP	NBR
2.375	3.375	.438	8486 H5L16	RUP	FKM
2.375	3.375	.438	8486 H5L89	RUP	FKM
2.375	3.375	.438	0237 3681	SPLIT	NBR
2.375	3.375	.438	0237 3681 V	SPLIT	FKM
2.375	3.375	.438	0237 9074	SPLIT	NBR
2.375	3.375	.500	0237 9597	SPLIT	NBR
2.375	3.375	.500	10899 H1L5	LPDW	NBR
2.375	3.375	.500	9409 H1L5	LUP	NBR
2.375	3.375	.500	9409 H5L16	LUP	FKM
2.375	3.418	.500	0237 17932	SPLIT	NBR
2.375	3.437	.500	0237 12596	SPLIT	NBR
2.375	3.480	.375	0237 14918	SPLIT	NBR
2.375	3.500	.313	0502 LDN 563 02375 313 VN	LDN	PTFE
2.375	3.500	.375	2375-3500-375ETBN	TB	NBR
2.375	3.500	.438	0237 16098	SPLIT	NBR
2.375	3.500	.469	0237 14921	SPLIT	NBR
2.375	3.500	.500	40044 H1L5	LDS	NBR
2.375	3.500	.500	9319 H1L5	LPD	NBR
2.375	3.500	.500	9319 H5L16	LPD	FKM
2.375	3.500	.500	9319 H5L16 PTFE	LPD	F/P
2.375	3.500	.625	13315 H1L5	LDS	NBR
2.375	3.500	.625	13315 H5L16	LDS	FKM
2.375	3.543	.250	2375-3543-250EVBN	VB	NBR
2.375	3.543	.375	15457 H1L5	LPD	NBR
2.375	3.623	.313	0502 LDN 624 02375 313 VN	LDN	PTFE
2.375	3.623	.359	2375-3623-359ETBN	TB	NBR
2.375	3.625	.438	16536 H1L5	LUP	NBR
2.375	3.750	.469	5931 H1L5	LUP	NBR
2.375	3.750	.469	5931 H5L16	LUP	FKM
2.375	3.750	.469	0237 9655	SPLIT	NBR
2.375	3.750	.470	17087 H1L5	RUP	NBR
2.375	3.750	.470	60027 ALLL5	LUP	NBR
2.375	3.875	.500	0237 15684	SPLIT	NBR
2.375	4.000	.500	16047 H1L5	LUP	NBR
2.375	6.375	.313	18422 H1L5	LUP	NBR
2.380	2.875	.313	4614 H1L5	B	NBR
2.380	2.875	.313	4614 H5L16	B	FKM
2.380	3.000	.250	12071 H1L5	LUP	NBR
2.393	3.281	.438	16899 H1MX9513	OLSS	SBR

See Section 4 for seal type description. For High Misalignment sizes, see Page B-86. For FlexiSeal Listings, see Pages B-93 and B-97.

03/03/06



B

Shaft Dia.	Bore Dia.	Seal Width	Parker Part Number	Seal Type	Material
2.406	3.125	.375	14839 H1L5	LPD	NBR
2.406	3.125	.375	14839 H5L16PTFE	LPD	F/P
2.406	3.157	.375	0240 3707	SPLIT	NBR
2.406	3.283	.375	0240 6060	SPLIT	NBR
2.410	5.256	.187	19734 H1L5	SS	NBR
2.437	3.125	.375	TMAL 3125-2422	TMAL	PTFE
2.437	3.500	.500	11143 H1L20	LUP	XNBR
2.437	3.500	.500	11143 H1L5	LUP	NBR
2.437	3.500	.500	11143 H1L5 PTFE	LUP	N/P
2.437	3.500	.500	11143 H1L70	LUP	NBR
2.437	3.500	.500	11143 H5L16	LUP	FKM
2.437	3.500	.500	TMAL 3500-3234	TMAL	PTFE
2.437	3.750	.500	16470 H1L5	LDS	NBR
2.437	3.750	.500	19614 H5L16	LDS	FKM
2.438	2.938	.188	11979 H1L7	SS	NBR
2.438	3.062	.313	0243 10214	SPLIT	NBR
2.438	3.063	.250	9698 H1L5	RPD	NBR
2.438	3.063	.313	0243 4374	SPLIT	NBR
2.438	3.063	.313	0243 4374 V	SPLIT	FKM
2.438	3.125	.313	0502 LDN 344 02438 313 VN	LDN	PTFE
2.438	3.125	.375	9171 H1L5	LUP	NBR
2.438	3.125	.375	9171 H1L5 PTFE	LUP	N/P
2.438	3.125	.375	9171 H5L16	LUP	FKM
2.438	3.125	.438	2438-3125-438ETBN	TB	NBR
2.438	3.130	.500	0243 19585	SPLIT	NBR
2.438	3.188	.375	0243 3707	SPLIT	NBR
2.438	3.188	.375	TMAL 3188-2424	TMAL	PTFE
2.438	3.188	.438	0243 7339	SPLIT	NBR
2.438	3.208	.197	16958	SS	XNBR
2.438	3.250	.313	0502 LDN 406 02438 313 VN	LDN	PTFE
2.438	3.250	.375	11660 H1L5	LPD	NBR
2.438	3.250	.375	11660 H1L7	LPD	NBR
2.438	3.250	.375	11660 H5L16	LPD	FKM
2.438	3.250	.375	0243 9648	SPLIT	NBR
2.438	3.250	.438	2438-3250-438ETBN	TB	NBR
2.438	3.251	.313	0502 LDN 407 02438 313 VN	LDN	PTFE
2.438	3.251	.438	2438-3251-438ETBN	TB	NBR
2.438	3.281	.436	13012 H1L5	OLSS	NBR
2.438	3.313	.437	0243 9055	SPLIT	NBR
2.438	3.313	.437	0243 9055 V	SPLIT	FKM
2.438	3.313	.500	9708 H1L5	RPD	NBR
2.438	3.314	.375	0243 6060	SPLIT	NBR
2.438	3.356	.438	0243 11230	SPLIT	NBR
2.438	3.375	.375	5439 H1L5	LUP	NBR
2.438	3.375	.375	5439 H5L16	LUP	FKM
2.438	3.375	.500	13498 H1L5	LPD	NBR
2.438	3.375	.500	13498 H5L16	LPD	FKM
2.438	3.375	.500	12450 H1L5	RPD	NBR
2.438	3.419	.500	0243 11248	SPLIT	NBR
2.438	3.435	.438	0243 8863	SPLIT	NBR
2.438	3.438	.438	0243 3681	SPLIT	NBR
2.438	3.438	.438	0243 3681 V	SPLIT	FKM
2.438	3.438	.500	14978 H1L5	LDS	NBR
2.438	3.438	.500	9597 H1L5	RPD	NBR
2.438	3.438	.500	9597 H5L16	RPD	FKM
2.438	3.481	.500	9825 H1L5	LUP	NBR
2.438	3.481	.500	9825 H5L16	LUP	FKM
2.438	3.481	.500	0243 17932	SPLIT	NBR
2.438	3.500	.250	9235 414	DS	CR
2.438	3.500	.313	0502 LDN 531 02438 313 VN	LDN	PTFE
2.438	3.500	.438	2438-3500-438ETBN	TB	NBR
2.438	3.500	.500	0243 12596	SPLIT	NBR
2.438	3.500	.500	0243 3911	SPLIT	NBR
2.438	3.500	.500	0243 3911 V	SPLIT	FKM
2.438	3.531	.500	6670 H1L5	LUP	NBR
2.438	3.547	.438	9374 H1L5	LPD	NBR

Shaft Dia.	Bore Dia.	Seal Width	Parker Part Number	Seal Type	Material
2.438	3.547	.438	9374 H5L16	LPD	FKM
2.438	3.547	.500	6432 H1L5	LA	NBR
2.438	3.547	.500	6432 H5L16	LA	FKM
2.438	3.558	.438	0243 16098	SPLIT	NBR
2.438	3.623	.375	10329 H1L5	LPD	NBR
2.438	3.625	.438	17124 H1L5	SSW	NBR
2.438	3.625	.500	10014 H1L5	LUP	NBR
2.438	3.625	.500	10014 H5L16	LUP	FKM
2.438	3.688	.438	0243 17413	SPLIT	NBR
2.438	3.750	.375	18021 H1L5	LDS	NBR
2.438	3.751	.375	13982 H1L5	LPD	NBR
2.438	3.751	.375	13982 H5L16	LPD	FKM
2.438	3.938	.500	0243 15684	SPLIT	NBR
2.438	3.938	.500	0243 15684 V	SPLIT	FKM
2.438	4.440	.350	20535 H1L5	SSW	NBR
2.438	4.724	.551	15007 H1L5	SSW	NBR
2.438	4.724	.551	15007 H5L16	SSW	FKM
2.440	3.250	.500	10120 H1L5	LUP	NBR
2.440	3.250	.500	10120 H5L16	LUP	FKM
2.441	3.346	.394	18764 5066	HP	FKM
2.441	3.346	.394	18764 5066 304	HP	FKM
2.441	3.346	.394	18764 5066 316	HP	FKM
2.450	4.000	.340	20425 MX5489	MP	FKM
2.456	3.375	.438	9073 H1L5	RPD	NBR
2.462	3.160	.207	19841 MX9508	SPEC	MX9508
2.468	3.350	.375	12675 H5L16	LPD	FKM
2.469	3.094	.313	0246 4374	SPLIT	NBR
2.469	3.219	.375	0246 3707	SPLIT	NBR
2.469	3.219	.438	0246 7339	SPLIT	NBR
2.469	3.335	.437	0246 9055	SPLIT	NBR
2.469	3.350	.375	12675 H1L5	LPD	NBR
2.480	3.235	.375	0248 3707	SPLIT	NBR
2.480	3.543	.591	19510 H1L5	RUP	NBR
2.489	3.250	.313	11151 H1L5	SS	NBR
2.489	3.250	.313	11151 H1L7	SS	FKM
2.494	3.082	.210	19891 MX9508	SPEC	MX9508
2.496	3.496	.438	0249 3681	SPLIT	NBR
2.498	3.250	.422	13041 ALLL7	P	NBR
2.498	3.501	.500	11814 H1L5	LPDW	NBR
2.498	3.501	.500	11814 H5L16	LPDW	FKM
2.498	3.501	.500	11814 HL15	LPDW	NBR
2.498	4.500	.500	11816 H1L20	SSW	XNBR
2.498	4.500	.500	11816 H1L5	SSW	NBR
2.499	3.542	.500	8865 H1L5	LPD	NBR
2.499	3.542	.500	8865 H5L89	LPD	FKM
2.500	2.879	.328	12321 ALLL7	P	NBR
2.500	2.879	.328	12321 ALLL70	P	NBR
2.500	3.000	.250	TN 3000-1616	TN	N/P
2.500	3.000	.250	TNV 3000-1616	TN	N/P
2.500	3.000	.250	2500-3000-250EVBN	VB	NBR
2.500	3.000	.313	14356 H1L7	P	NBR
2.500	3.000	.313	14356 H5L16	P	FKM
2.500	3.063	.438	6012 H1L7	SS	NBR
2.500	3.063	.438	6012 H5L16	SS	FKM
2.500	3.094	.313	4092 H1L5	B	NBR
2.500	3.125	.313	15117 H1L5	LPDW	NBR
2.500	3.125	.313	9485 H1L5	LUP	NBR
2.500	3.125	.313	9485 H1L7	LUP	NBR
2.500	3.125	.313	9485 H5L16	LUP	FKM
2.500	3.125	.313	0250 7362	SPLIT	NBR
2.500	3.125	.313	0250 10214	SPLIT	NBR
2.500	3.125	.313	0250 4374	SPLIT	NBR
2.500	3.188	.375	16699 5066	HP	FKM
2.500	3.188	.375	16699 5066 304	HP	FKM
2.500	3.188	.375	16699 5066 316	HP	FKM
2.500	3.188	.375	16699 MX5489 PT	HP	F/P

See Section 4 for seal type description. For High Misalignment sizes, see Page B-86. For FlexiSeal Listings, see Pages B-93 and B-97.

03/03/06



B

Shaft Dia.	Bore Dia.	Seal Width	Parker Part Number	Seal Type	Material
2.500	3.188	.375	10184 H1L5	LUP	NBR
2.500	3.188	.375	10184 H5L16	LUP	FKM
2.500	3.188	.375	18720 H5L16	LUP	FKM
2.500	3.188	.375	16905 H1L5	RUP	NBR
2.500	3.189	.313	0502 LDN 345 02500 313 VN	LDN	PTFE
2.500	3.189	.375	2500-3189-375ETBN	TB	NBR
2.500	3.250	.375	17256 H1L5	LDS	NBR
2.500	3.250	.375	17256 H5L16	LDS	FKM
2.500	3.250	.375	0250 3707	SPLIT	NBR
2.500	3.250	.375	0250 3707 PTFE	SPLIT	N/P
2.500	3.250	.375	0250 3707 V	SPLIT	FKM
2.500	3.250	.437	9790 H1L5	LUP	NBR
2.500	3.250	.437	9790 H1L5 PTFE	LUP	N/P
2.500	3.250	.437	9790 H1L20	LUP	XNBR
2.500	3.250	.437	9790 H1L50	LUP	NBR
2.500	3.250	.437	9790 H5L16	LUP	FKM
2.500	3.250	.437	9790 H5L16 PTFE	LUP	F/P
2.500	3.250	.437	9790 H5MX5489	LUP	FKM
2.500	3.250	.437	19824	MP	FKM
2.500	3.250	.437	19824 2412	MP	FKM
2.500	3.250	.438	0250 7339	SPLIT	NBR
2.500	3.250	.438	0250 7339 V	SPLIT	FKM
2.500	3.250	.500	9282 H1L7	H	NBR
2.500	3.250	.500	15566 H1L5	LDS	NBR
2.500	3.250	.500	15566 H5L16	LDS	FKM
2.500	3.250	.500	9751 H1L5	LUP	NBR
2.500	3.250	.500	9751 H5L89	LUP	FKM
2.500	3.250	.500	9751 H5L89 PTFE	LUP	F/P
2.500	3.251	.313	0502 LDN 376 02500 313 VN	LDN	PTFE
2.500	3.251	.375	2500-3251-375ETBN	TB	NBR
2.500	3.316	.375	9648 H1L5	RUP	NBR
2.500	3.316	.375	9648 H5L16	RUP	FKM
2.500	3.350	.250	10345 H1L5	LPD	NBR
2.500	3.350	.250	10345 H5L16	LPD	FKM
2.500	3.350	.500	8496 H1L5	LPD	NBR
2.500	3.350	.500	8496 H5L16	LPD	FKM
2.500	3.371	.313	0502 LDN 436 02500 313 VN	LDN	PTFE
2.500	3.371	.438	2500-3371-438ETBN	TB	NBR
2.500	3.375	.437	0250 9055	SPLIT	NBR
2.500	3.375	.437	0250 9055 H1L21	SPLIT	EPDM
2.500	3.375	.437	0250 9055 V	SPLIT	FKM
2.500	3.375	.500	10797 H1L5	LPD	NBR
2.500	3.375	.500	10797 H5L16	LPD	FKM
2.500	3.375	.500	10034 H1L5	RPD	NBR
2.500	3.375	.500	10034 H5L16	RPD	FKM
2.500	3.375	.500	TMAL 3375-3228	TMAL	PTFE
2.500	3.376	.375	13339 H1L5	LPD	NBR
2.500	3.376	.375	13339 H5L16	LPD	FKM
2.500	3.376	.375	13339 H5MX5489	LPD	FKM
2.500	3.417	.438	0250 11230	SPLIT	NBR
2.500	3.475	.469	4882 H1L5	B	NBR
2.500	3.481	.500	0250 11248	SPLIT	NBR
2.500	3.500	.250	16933 H1L5	LUP	NBR
2.500	3.500	.250	17555 H1L5	SS	NBR
2.500	3.500	.250	17555 H1L7	SS	NBR
2.500	3.500	.250	17555 H5L16	SS	FKM
2.500	3.500	.250	TMAL 3500-1632	TMAL	PTFE
2.500	3.500	.250	2500-3500-250EVBN	VB	NBR
2.500	3.500	.313	0502 LDN 500 02500 313 VN	LDN	PTFE
2.500	3.500	.375	0250 10325	SPLIT	NBR
2.500	3.500	.375	0250 10325 V	SPLIT	FKM
2.500	3.500	.375	19353 H1L5	SSW	NBR
2.500	3.500	.375	19353 MX9010L21	SSW	EPDM
2.500	3.500	.375	2500-3500-375ETBN	TB	NBR
2.500	3.500	.438	10208 H1L20	LUP	XNBR
2.500	3.500	.438	10208 H1L5	LUP	NBR

Shaft Dia.	Bore Dia.	Seal Width	Parker Part Number	Seal Type	Material
2.500	3.500	.438	10208 H1L5 PTFE	LUP	N/P
2.500	3.500	.438	10208 H5L16	LUP	FKM
2.500	3.500	.438	10208 H5L16PTFE	LUP	F/P
2.500	3.500	.438	9074 H1L5	R	NBR
2.500	3.500	.438	9074 H5L16	R	FKM
2.500	3.500	.438	0250 3681	SPLIT	NBR
2.500	3.500	.438	0250 3681 V	SPLIT	FKM
2.500	3.500	.438	0250 8863	SPLIT	NBR
2.500	3.500	.438	0250 8863 V	SPLIT	FKM
2.500	3.500	.500	16203 H1L5	H	NBR
2.500	3.500	.500	16203 H1L7	H	NBR
2.500	3.500	.500	16203 H5L16	H	FKM
2.500	3.500	.500	14620 H1L5	LDS	NBR
2.500	3.500	.500	14620 H1L70	LDS	NBR
2.500	3.500	.500	14620 H5L16	LDS	FKM
2.500	3.500	.500	10121 H1L5	LUP	NBR
2.500	3.500	.500	10121 H1L5 PTFE	LUP	N/P
2.500	3.500	.500	10121 H5L16	LUP	FKM
2.500	3.500	.500	10121 H5MX5489	LUP	FKM
2.500	3.500	.500	19203 H1L5	LUPW	NBR
2.500	3.500	.500	10619 H1L7	SS	NBR
2.500	3.500	.500	10619 H1L7 PTFE	SS	N/P
2.500	3.500	.500	TMAL 3500-3232	TMAL	PTFE
2.500	3.500	.750	12036 H1L7	P	NBR
2.500	3.505	.500	7030 H1L5	LA	NBR
2.500	3.543	.313	0502 LDN 522 02500 313 VN	LDN	PTFE
2.500	3.543	.375	11167 H1L5	LPD	NBR
2.500	3.543	.375	11167 H5L16	LPD	FKM
2.500	3.543	.438	2500-3543-438ETBN	TB	NBR
2.500	3.543	.500	10953 H1L5	LUP	NBR
2.500	3.543	.500	10953 H5L16	LUP	FKM
2.500	3.543	.500	0250 17932	SPLIT	NBR
2.500	3.543	1.375	0250 5502	SPLIT	NBR
2.500	3.548	.438	5598 H1L5	LUP	NBR
2.500	3.548	.438	5598 H1L5 PTFE	LUP	N/P
2.500	3.548	.438	5598 H1L70	LUP	NBR
2.500	3.548	.438	5598 H5L16	LUP	FKM
2.500	3.548	.469	6924 H1L5	LA	NBR
2.500	3.548	.625	13771 H1L5	LDS	NBR
2.500	3.548	.625	13771 H1L2160	LDS	EPDM
2.500	3.563	.500	12596 H1L5	RPD	NBR
2.500	3.605	.375	14918 H1L5	RPD	NBR
2.500	3.623	.313	0502 LDN 562 02500 313 VN	LDN	PTFE
2.500	3.623	.375	2500-3623-375ETBN	TB	NBR
2.500	3.623	.500	9863 H1L5	LPD	NBR
2.500	3.623	.500	9863 H5L16	LPD	FKM
2.500	3.623	.500	9863 H5L89	LPD	FKM
2.500	3.625	.469	0250 9386	SPLIT	NBR
2.500	3.625	.469	14921 H1L5	RPD	NBR
2.500	3.750	.375	17643 H1L5	LUP	NBR
2.500	3.750	.438	10036 H1L5	LPD	NBR
2.500	3.750	.438	10036 H5L16	LPD	FKM
2.500	3.750	.438	0250 17413	SPLIT	NBR
2.500	3.750	.500	5744 H1L5	LUP	NBR
2.500	3.750	.500	5744 H5L16	LUP	FKM
2.500	3.750	.563	13244 H1L5	LPDW	NBR
2.500	3.751	.313	0502 LDN 626 02500 313 VN	LDN	PTFE
2.500	3.751	.438	2500-3751-438ETBN	TB	NBR
2.500	3.875	.375	7027 H1L5	LA	NBR
2.500	3.875	.375	7027 H1L5 PTFE	LA	N/P
2.500	3.875	.375	12883 H1L5	LDS	NBR
2.500	3.875	.469	9655 H1L5	RPD	NBR
2.500	3.876	.313	0502 LDN 688 02500 313 VN	LDN	PTFE
2.500	3.876	.438	2500-3876-438ETBN	TB	NBR
2.500	3.930	.500	19287 H1L5	SSW	NBR
2.500	3.938	.563	14048 H1L5	LPDW	NBR

See Section 4 for seal type description. For High Misalignment sizes, see Page B-86. For FlexiSeal Listings, see Pages B-93 and B-97.

03/03/06



B

Shaft Dia.	Bore Dia.	Seal Width	Parker Part Number	Seal Type	Material
2.500	4.000	.500	8497 H1L5	LUP	NBR
2.500	4.000	.500	8497 H5L16	LUP	FKM
2.500	4.000	.500	0250 15684	SPLIT	NBR
2.500	4.000	.500	0250 15684 V	SPLIT	FKM
2.500	4.000	.750	15411 5066	HP	FKM
2.500	4.000	.750	15411 5066 304	HP	FKM
2.500	4.000	.750	15411 5066 316	HP	FKM
2.500	4.003	.313	0502 LDN 752 02500 313 VN	LDN	PTFE
2.500	4.003	.375	2500-4003-375ETAN	TA	NBR
2.500	4.004	.250	5542 H1L5	LPD	NBR
2.500	4.330	1.000	3852 H1L5	B	NBR
2.500	4.331	.563	14053 H1L5	LPDW	NBR
2.500	4.726	.470	14052 H1L5	LPDW	NBR
2.500	4.750	.469	5474 H1L5	RUP	NBR
2.500	5.000	.406	11978 H1L5	SSW	NBR
2.505	3.625	.250	19476 H1L5	LUP	NBR
2.520	3.308	.512	18522 H1L5	RUP	NBR
2.520	3.308	.512	18522 H5L16	RUP	FKM
2.531	3.625	.438	7163 H1L5	LPD	NBR
2.532	3.157	.313	0253 10214	SPLIT	NBR
2.532	3.532	.375	0253 10325 V	SPLIT	FKM
2.532	3.532	.438	0253 8863	SPLIT	NBR
2.553	3.938	.375	11801 H1L5	LDS	NBR
2.553	3.938	.375	11801 H5L89	LDS	FKM
2.558	5.512	.500	13281 H1L5	LDS	NBR
2.559	3.031	.354	16245 H1L7	P	NBR
2.559	3.150	.394	17796 H1L5	LUP	NBR
2.559	3.150	.394	17796 H5MX5489	LUP	FKM
2.559	3.346	.394	17760 H1L5	LUP	NBR
2.559	3.346	.394	17760 H5L16	LUP	FKM
2.559	3.346	.394	30052 H5L89	LUP	FKM
2.559	3.346	.433	13845 H1L7	P	NBR
2.559	3.425	.395	13178 H1L5	SSW	NBR
2.559	3.541	.375	14610 H1L5	LPD	NBR
2.559	3.541	.375	14610 H1L5 PTFE	LPD	N/P
2.559	3.541	.375	14610 H5L16	LPD	FKM
2.559	3.543	.394	15308 H1L5	RPD	NBR
2.559	3.559	.438	0255 3681	SPLIT	NBR
2.559	3.750	.375	70004 H1L5	TSS	NBR
2.559	3.938	.375	40039 H1L5	LDS	NBR
2.559	3.938	.375	40039 H5L16	LDS	FKM
2.559	3.938	.472	18376 H1L5	LUP	NBR
2.560	3.198	.142	19330 H1L5	SS	NBR
2.560	3.250	1.000	3980 H1L5	B	NBR
2.562	3.250	.375	7214 H1L5	LUP	NBR
2.562	3.250	.375	7214 H5L16	LUP	FKM
2.562	3.625	.500	6869 H1L5	LUP	NBR
2.562	3.625	.500	6869 H5L16	LUP	FKM
2.563	3.158	.313	0256 7362	SPLIT	NBR
2.563	3.188	.313	0256 10214	SPLIT	NBR
2.563	3.313	.375	17183 5066	HP	FKM
2.563	3.313	.375	17183 5066 304	HP	FKM
2.563	3.313	.375	17183 5066 316	HP	FKM
2.563	3.313	.375	17183 SPEC	HP	FKM
2.563	3.375	.469	16537 H1L5	LUP	NBR
2.563	3.375	.469	16537 H5L16	LUP	FKM
2.563	3.438	.313	0256 9667	SPLIT	NBR
2.563	3.439	.375	6060 H1L5	RUP	NBR
2.563	3.439	.375	6060 H5L16	RUP	FKM
2.563	3.480	.438	0256 11230	SPLIT	NBR
2.563	3.500	.375	9188 H1L5	LPD	NBR
2.563	3.500	.375	9188 H5L16	LPD	FKM
2.563	3.563	.375	0256 10325	SPLIT	NBR
2.563	3.563	.438	0256 8863	SPLIT	NBR
2.563	3.563	.500	0256 10230	SPLIT	NBR
2.563	3.688	.438	16098 H1L5	RUP	NBR

Shaft Dia.	Bore Dia.	Seal Width	Parker Part Number	Seal Type	Material
2.563	3.688	.469	0256 9386	SPLIT	NBR
2.563	3.750	.500	19049 H1L5	LDS	NBR
2.563	3.751	.500	13768 H1L5	LUP	NBR
2.563	3.875	.438	0256 5871	SPLIT	NBR
2.575	3.575	.375	0257 16390	SPLIT	NBR
2.594	3.484	.500	13951 H1L5	LPD	NBR
2.594	3.484	.500	15474 H1L5	LDS	NBR
2.594	3.484	.500	15474 H5L16	LDS	FKM
2.594	3.594	.375	0259 10325	SPLIT	NBR
2.594	3.594	.438	0259 8863	SPLIT	NBR
2.594	3.594	.438	0259 8863 V	SPLIT	FKM
2.594	3.594	.500	0259 10230	SPLIT	NBR
2.594	3.719	.469	0259 9386	SPLIT	NBR
2.598	3.750	.281	17718 H1L5	SSW	NBR
2.620	3.250	.313	17047 H1L5	LUPW	NBR
2.620	3.250	.313	17047 H5L16	LUPW	FKM
2.620	3.618	.437	4903 H1L5	RUP	NBR
2.625	3.220	.313	0262 7362	SPLIT	NBR
2.625	3.250	.313	4374 H1L5	RUP	NBR
2.625	3.250	.313	4374 H5MX5489	RUP	FKM
2.625	3.250	.313	0262 10214	SPLIT	NBR
2.625	3.250	.313	0262 10214 V	SPLIT	FKM
2.625	3.250	.375	0262 14525	SPLIT	NBR
2.625	3.350	.375	9452 H1L5	LPD	NBR
2.625	3.350	.469	18914 H1L5	LUP	NBR
2.625	3.372	.438	6883 H1L5	LA	NBR
2.625	3.372	.438	6883 H5MX5489	LA	FKM
2.625	3.375	.375	15390 5066	HP	FKM
2.625	3.375	.375	15390 5066 304	HP	FKM
2.625	3.375	.375	15390 5066 316	HP	FKM
2.625	3.375	.375	0502 LDN 375 02625 375 VN	LDN	PTFE
2.625	3.375	.375	3707 H1L5	RUP	NBR
2.625	3.375	.375	3707 H1L5 PTFE	RUP	N/P
2.625	3.375	.375	3707 H5L16	RUP	FKM
2.625	3.375	.375	2625-3375-375ETBN	TB	NBR
2.625	3.375	.438	8468 H1L5	LUP	NBR
2.625	3.375	.438	8468 H5L16	LUP	FKM
2.625	3.375	.438	7339 H1L5	RPD	NBR
2.625	3.375	.438	7339 H5L16	RPD	FKM
2.625	3.375	.438	0262 4268	SPLIT	NBR
2.625	3.406	.438	0262 4268	SPLIT	NBR
2.625	3.434	.500	19272 ALLL5	LUP	NBR
2.625	3.440	.494	18462 ALLL5	LUP	NBR
2.625	3.500	.313	0262 11604	SPLIT	NBR
2.625	3.500	.375	0502 LDN 438 02625 375 VN	LDN	PTFE
2.625	3.500	.375	11017 H1L5	LUP	NBR
2.625	3.500	.375	11017 H5L16	LUP	FKM
2.625	3.500	.375	2625-3500-375ETBN	TB	NBR
2.625	3.500	.437	16636 H1L5	LUP	NBR
2.625	3.500	.437	16636 H5L16	LUP	FKM
2.625	3.500	.437	16636 H5L16PTFE	LUP	F/P
2.625	3.500	.437	9055 H1L5	RUP	NBR
2.625	3.500	.437	9055 H5L16	RUP	FKM
2.625	3.500	.437	9055 H5L16 PTFE	RUP	F/P
2.625	3.500	.438	0262 4053	SPLIT	NBR
2.625	3.500	.438	0262 4053 V	SPLIT	FKM
2.625	3.500	.500	13858 H1L5	LDS	NBR
2.625	3.500	.500	13858 H5L16	LDS	FKM
2.625	3.500	.500	40042 H1L5	LDS	NBR
2.625	3.500	.500	40042 H5L16	LDS	FKM
2.625	3.500	.500	10910 H1L5	LPD	NBR
2.625	3.500	.500	10910 H1L5 PTFE	LPD	N/P
2.625	3.500	.500	10910 H5L16	LPD	FKM
2.625	3.543	.438	11833 H1L5	LPD	NBR
2.625	3.606	.500	11248 H1L5	RPD	NBR
2.625	3.623	.375	0502 LDN 499 02625 375 VN	LDN	PTFE

See Section 4 for seal type description. For High Misalignment sizes, see Page B-86. For FlexiSeal Listings, see Pages B-93 and B-97.

03/03/06



B

Shaft Dia.	Bore Dia.	Seal Width	Parker Part Number	Seal Type	Material
2.625	3.623	.375	2625-3623-375ETBN	TB	NBR
2.625	3.623	.500	12141 H1L5	LPDW	NBR
2.625	3.625	.375	0262 10325	SPLIT	NBR
2.625	3.625	.375	TMAL 3625-2432	TMAL	PTFE
2.625	3.625	.438	10050 H1L5	LUP	NBR
2.625	3.625	.438	10050 H5L16	LUP	FKM
2.625	3.625	.438	10050 H5MX5489	LUP	FKM
2.625	3.625	.438	3681 H1L5	RPD	NBR
2.625	3.625	.438	3681 H5L16	RPD	FKM
2.625	3.625	.438	0262 8863	SPLIT	NBR
2.625	3.625	.438	TMAL 3625-2832	TMAL	PTFE
2.625	3.625	.469	4220 H1L5	LPD	NBR
2.625	3.625	.469	4220 H5L16	LPD	FKM
2.625	3.625	.500	7110 H1L5	LUP	NBR
2.625	3.625	.500	7110 H5L16	LUP	FKM
2.625	3.625	.500	7110 H5L16 PTFE	LUP	F/P
2.625	3.625	.500	19070 ALLL5	RPD	NBR
2.625	3.625	.500	19070 H1L5	RPD	NBR
2.625	3.625	.500	0262 10230	SPLIT	NBR
2.625	3.625	.500	0262 10230 V	SPLIT	FKM
2.625	3.668	.500	17932 H1L5	RUP	NBR
2.625	3.668	1.375	5502 H1L5	B	NBR
2.625	3.678	.500	20420 H1L5	LDS	NBR
2.625	3.748	.500	0262 4107	SPLIT	NBR
2.625	3.750	.375	0502 LDN 563 02625 375 VN	LDN	PTFE
2.625	3.750	.375	6235 H1L5	LPD	NBR
2.625	3.750	.375	6235 H5L16	LPD	FKM
2.625	3.750	.375	0262 12642	SPLIT	NBR
2.625	3.750	.375	2625-3750-375ETBN	TB	NBR
2.625	3.750	.469	0262 9386	SPLIT	NBR
2.625	3.750	.500	5745 H1L5	LPD	NBR
2.625	3.750	.500	5745 H5L16	LPD	FKM
2.625	3.754	.500	0262 4107 V	SPLIT	FKM
2.625	3.875	.438	17413 H1L5	RUP	NBR
2.625	3.875	.468	14831 H1L5	LDS	NBR
2.625	3.875	.469	8505 H1L5	LPD	NBR
2.625	3.875	.500	0262 4314	SPLIT	NBR
2.625	3.938	.438	17905 H1L5	LDS	NBR
2.625	4.003	.500	4840 H1L5	LA	NBR
2.625	4.003	.500	4840 H5L16	LA	FKM
2.625	4.063	.278	16416 H1L5	SSW	NBR
2.625	4.063	.278	16416 H5L16	SSW	FKM
2.625	4.125	.500	15684 H1L5	RPD	NBR
2.625	4.125	.500	15684 H5L16	RPD	FKM
2.625	4.250	.500	15008 H1L5	SSW	NBR
2.625	4.438	.500	10028 H1L5	LPD	NBR
2.625	4.500	.875	18269 H1L5	LDS	NBR
2.625	4.630	.350	20536 H1L5	SSW	NBR
2.625	4.724	.551	15006 H1L5	SSW	NBR
2.630	3.250	.300	18519 H1L5	LUP	NBR
2.630	3.250	.300	18519 H5L16	LUP	FKM
2.632	3.150	.512	0236 18522	SPLIT	NBR
2.632	3.150	.512	0236 18522 V	SPLIT	FKM
2.647	3.678	.500	TN 3678-3233	TN	N/P
2.647	3.678	.500	TNV 3678-3233	TN	N/P
2.656	3.407	.438	0265 4268	SPLIT	NBR
2.656	3.532	.438	0265 4053	SPLIT	NBR
2.656	3.532	.438	0265 4053 V	SPLIT	FKM
2.656	3.657	.438	0265 6895	SPLIT	NBR
2.670	3.670	.375	0267 16390	SPLIT	NBR
2.677	3.150	.354	14706 H5L16	P	FKM
2.687	3.750	.500	TMAL 3750-3234	TMAL	PTFE
2.688	3.344	.375	0268 14525	SPLIT	NBR
2.688	3.372	.375	16334 5066	HP	FKM
2.688	3.372	.375	16334 5066 304	HP	FKM
2.688	3.372	.375	16334 5066 316	HP	FKM

Shaft Dia.	Bore Dia.	Seal Width	Parker Part Number	Seal Type	Material
2.688	3.372	.375	11142 H1L5	LPD	NBR
2.688	3.372	.375	11142 H5L16	LPD	FKM
2.688	3.375	.375	0268 5684	SPLIT	NBR
2.688	3.380	.500	19585 H1L5	RUP	NBR
2.688	3.438	.375	0268 8472	SPLIT	NBR
2.688	3.438	.438	0268 4268	SPLIT	NBR
2.688	3.500	.500	0268 5464	SPLIT	NBR
2.688	3.563	.313	0268 11604	SPLIT	NBR
2.688	3.563	.438	0268 4053	SPLIT	NBR
2.688	3.605	.438	11230 H1L5	RPD	NBR
2.688	3.687	.500	0268 10230	SPLIT	NBR
2.688	3.688	.375	0268 16390	SPLIT	NBR
2.688	3.688	.438	0268 6895	SPLIT	NBR
2.688	3.750	.250	9089 414	DS	CR
2.688	3.750	.375	0502 LDN 531 02688 375 VN	LDN	PTFE
2.688	3.750	.375	0268 5667	SPLIT	NBR
2.688	3.750	.375	0268 5667 V	SPLIT	FKM
2.688	3.750	.438	0268 10168	SPLIT	NBR
2.688	3.750	.438	2688-3750-438ETBN	TB	NBR
2.688	3.750	.500	9541 H1L5	LUP	NBR
2.688	3.750	.500	9541 H1L7	LUP	NBR
2.688	3.750	.500	9541 H5L16	LUP	FKM
2.688	3.750	.500	10040 H1L5	OLRPD	NBR
2.688	3.750	.500	10040 H5L16	OLRPD	FKM
2.688	3.750	.500	3911 H1L5	RUP	NBR
2.688	3.750	.500	3911 H5L16	RUP	FKM
2.688	3.813	.469	0268 9386	SPLIT	NBR
2.688	3.875	.469	16752 H1L5	LUP	NBR
2.688	3.875	.469	16752 H5L89	LUP	FKM
2.688	3.875	.500	17310 H1L5	OLLUP	NBR
2.688	3.875	.500	17310 H5L16	OLLUP	FKM
2.688	3.938	.500	0268 4314	SPLIT	NBR
2.688	4.000	.438	0268 5871	SPLIT	NBR
2.688	4.003	.375	0502 LDN 658 02688 375 VN	LDN	PTFE
2.688	4.003	.438	2688-4003-438ETBN	TB	NBR
2.700	3.372	.375	14847 H1L5	LDS	NBR
2.719	3.469	.375	0271 8472	SPLIT	NBR
2.719	3.481	.375	12485 H1L5	LPD	NBR
2.719	3.719	.438	0271 6895	SPLIT	NBR
2.719	3.719	.500	0271 9370	SPLIT	NBR
2.734	4.999	.500	20817 H5L16	LDS	FKM
2.734	4.999	.500	60020 H1L5	LDS	NBR
2.734	4.999	.500	60020 H5L16	LDS	FKM
2.734	4.999	.500	20771 H5L16	LUP	FKM
2.735	3.735	.438	0273 6895	SPLIT	NBR
2.748	3.500	.420	12523 ALLL7	P	NBR
2.750	3.125	.328	15107 ALLL7	P	NBR
2.750	3.250	.250	5884 H1L7	SS	NBR
2.750	3.250	.250	5884 H5L16	SS	FKM
2.750	3.313	.250	5038 414	DS	CR
2.750	3.345	.313	7362 H1L5	RPD	NBR
2.750	3.375	.313	16397 5066	HP	FKM
2.750	3.375	.313	16397 5066 304	HP	FKM
2.750	3.375	.313	16397 5066 316	HP	FKM
2.750	3.375	.313	16397 SPEC	HP	FKM
2.750	3.375	.313	10526 H1L21	LUP	EPDM
2.750	3.375	.313	10526 H1L5	LUP	NBR
2.750	3.375	.313	10526 H5L16	LUP	FKM
2.750	3.375	.313	17114 ALLL5	MCLDS	NBR
2.750	3.375	.313	10214 H1L5	RPD	NBR
2.750	3.375	.313	10214 H5L16	RPD	FKM
2.750	3.375	.313	0275 18235	SPLIT	NBR
2.750	3.375	.313	0275 18235 V	SPLIT	FKM
2.750	3.375	.375	0275 14525	SPLIT	NBR
2.750	3.438	.375	0275 5684	SPLIT	NBR
2.750	3.481	.375	12725 H1L5	LPD	NBR

See Section 4 for seal type description. For High Misalignment sizes, see Page B-86. For FlexiSeal Listings, see Pages B-93 and B-97.

03/03/06



Rotary Lip Seal Inch Sizes

2.750 to 2.756

B

Shaft Dia.	Bore Dia.	Seal Width	Parker Part Number	Seal Type	Material
2.750	3.481	.375	12725 H5MX5489	LPD	FKM
2.750	3.500	.156	12916 H1L7	SS	NBR
2.750	3.500	.250	16658 H1L7	SS	NBR
2.750	3.500	.375	0502 LDN 375 02750 375 VN	LDN	PTFE
2.750	3.500	.375	14042 H1L20	LPD	XNBR
2.750	3.500	.375	14042 H1L5	LPD	NBR
2.750	3.500	.375	14042 H1L5 PTFE	LPD	N/P
2.750	3.500	.375	14042 H5L16	LPD	FKM
2.750	3.500	.375	0275 8472	SPLIT	NBR
2.750	3.500	.375	2750-3500-375ETBN	TB	NBR
2.750	3.500	.410	11985 H1L7	P	NBR
2.750	3.500	.410	11985 H5L16	P	FKM
2.750	3.500	.438	16471 H1L5	LDS	NBR
2.750	3.500	.438	16471 H5L16	LDS	FKM
2.750	3.500	.438	0275 4268	SPLIT	NBR
2.750	3.500	.438	0275 4268 PS	SPLIT	NBR
2.750	3.500	.438	0275 4268 V	SPLIT	FKM
2.750	3.500	.500	11894 H1L5	LPD	NBR
2.750	3.500	.500	11894 H5L16	LPD	FKM
2.750	3.500	.500	14781 H1L5	LDS	NBR
2.750	3.500	.500	14781 H5L16	LDS	FKM
2.750	3.500	.500	TMAL 3500-3224	TMAL	PTFE
2.750	3.500	.562	10635 H1L5	LDS	NBR
2.750	3.500	.562	10635 H5L16	LDS	FKM
2.750	3.505	.438	10364 H1L5	LPD	NBR
2.750	3.543	.375	0502 LDN 397 02750 375 VN	LDN	PTFE
2.750	3.543	.438	2750-3543-438ETBN	TB	NBR
2.750	3.543	.438	8470 H1L5	LUP	NBR
2.750	3.543	.438	8470 H5L16	LUP	FKM
2.750	3.543	.483	0275 17472	SPLIT	NBR
2.750	3.543	.500	11420 H1L7	SS	NBR
2.750	3.544	.625	16190 H1L5	LDS	NBR
2.750	3.563	.375	11773 414	DS	CR
2.750	3.563	.500	0275 5464	SPLIT	NBR
2.750	3.623	.375	0502 LDN 437 02750 375 VN	LDN	PTFE
2.750	3.623	.375	2750-3623-375ETBN	TB	NBR
2.750	3.625	.250	11619 414	DS	CR
2.750	3.625	.313	0275 11604	SPLIT	NBR
2.750	3.625	.437	TMAL 3625-2828	TMAL	PTFE
2.750	3.625	.438	15672 5066	HP	FKM
2.750	3.625	.438	15672 5066 304	HP	FKM
2.750	3.625	.438	15672 5066 316	HP	FKM
2.750	3.625	.438	12494 H1L5	LPD	NBR
2.750	3.625	.438	12494 H1L5 PTFE	LPD	N/P
2.750	3.625	.438	12494 H5L16	LPD	FKM
2.750	3.625	.438	0275 4053	SPLIT	NBR
2.750	3.669	.375	17396 H1L5	LDS	NBR
2.750	3.750	.313	10761 H1L5	LPD	NBR
2.750	3.750	.313	10761 H5L16	LPD	FKM
2.750	3.750	.375	7128 H1L5	LUP	NBR
2.750	3.750	.375	7128 H5L16	LUP	FKM
2.750	3.750	.375	7128 H5MX5489	LUP	FKM
2.750	3.750	.375	10325 H1L5	RPD	NBR
2.750	3.750	.375	10325 H5L16	RPD	FKM
2.750	3.750	.375	0275 16390	SPLIT	NBR
2.750	3.750	.375	0275 16390 V	SPLIT	FKM
2.750	3.750	.375	TMAL 3750-2432	TMAL	PTFE
2.750	3.750	.438	10304 H1L2160	LPD	EPDM
2.750	3.750	.438	10304 H1L5	LPD	NBR
2.750	3.750	.438	10304 H5L16	LPD	FKM
2.750	3.750	.438	6257 H1L5	LPD	NBR
2.750	3.750	.438	6257 H1L5 PTFE	LPD	N/P
2.750	3.750	.438	6257 H5L16	LPD	FKM
2.750	3.750	.438	6257 H5L16 PTFE	LPD	F/P
2.750	3.750	.438	6257 HL15	LPD	NBR
2.750	3.750	.438	8863 H1L5	RUP	NBR

Shaft Dia.	Bore Dia.	Seal Width	Parker Part Number	Seal Type	Material
2.750	3.750	.438	8863 H5L16	RUP	FKM
2.750	3.750	.438	0275 6895	SPLIT	NBR
2.750	3.750	.438	0275 6895 V	SPLIT	FKM
2.750	3.750	.500	17603 H1L5	H	NBR
2.750	3.750	.500	17822 H1L5	LPD	NBR
2.750	3.750	.500	9732 H1L5	LUP	NBR
2.750	3.750	.500	9732 H1L5 PTFE	LUP	N/P
2.750	3.750	.500	9732 H1L50	LUP	NBR
2.750	3.750	.500	9732 H1L7	LUP	NBR
2.750	3.750	.500	9732 H5L16	LUP	FKM
2.750	3.750	.500	11023 H1L5	LUPW	NBR
2.750	3.750	.500	11023 H1L50	LUPW	NBR
2.750	3.750	.500	1269175H1	LUPW	H1L50
2.750	3.750	.500	0275 10230	SPLIT	NBR
2.750	3.750	.500	0275 10230 H1L7	SPLIT	NBR
2.750	3.750	.500	0275 9370	SPLIT	NBR
2.750	3.750	.500	0275 9370 V	SPLIT	FKM
2.750	3.750	.500	TMAL 3750-3232	TMAL	PTFE
2.750	3.750	.562	14374 H1L5	LDS	NBR
2.750	3.750	.562	16242 H1L20	LDS	XNBR
2.750	3.750	.562	16242 H1L5	LDS	NBR
2.750	3.750	.562	16242 H5L16	LDS	FKM
2.750	3.751	.250	2750-3751-250EVBN	VB	NBR
2.750	3.751	.375	0502 LDN 501 02750 375 VN	LDN	PTFE
2.750	3.751	.438	2750-3751-438ETBN	TB	NBR
2.750	3.752	.610	6140 H1L5	LA	NBR
2.750	3.875	.500	0275 3706	SPLIT	NBR
2.750	3.875	.500	0275 3706 V	SPLIT	FKM
2.750	3.876	.375	0502 LDN 563 02750 375 VN	LDN	PTFE
2.750	3.876	.375	2750-3876-375ETBN	TB	NBR
2.750	3.878	.500	0275 4107	SPLIT	NBR
2.750	3.880	.500	5613 H1L5	LPD	NBR
2.750	3.880	.500	5613 H5L16	LPD	FKM
2.750	3.880	.500	5613 HL15	LPD	NBR
2.750	3.881	.750	14000 H1L5	LDS	NBR
2.750	4.000	.438	16616 H1L20	SSW	XNBR
2.750	4.000	.438	16616 H1L2160	SSW	EPDM
2.750	4.000	.438	16616 H1L5	SSW	NBR
2.750	4.000	.438	16616 H5L89	SSW	FKM
2.750	4.000	.500	40025 H1L5	LDS	NBR
2.750	4.000	.500	18958 ALLL16	LUP	FKM
2.750	4.000	.500	0275 4314	SPLIT	NBR
2.750	4.000	.688	19351 412	DS	CR
2.750	4.003	.375	0502 LDN 627 02750 375 VN	LDN	PTFE
2.750	4.003	.438	2750-4003-438ETBN	TB	NBR
2.750	4.003	.469	10044 H1L21	LPD	EPDM
2.750	4.003	.469	10044 H1L5	LPD	NBR
2.750	4.003	.469	10044 H5L16	LPD	FKM
2.750	4.020	.500	0275 10759	SPLIT	NBR
2.750	4.125	.438	8436 H1L5	LUP	NBR
2.750	4.125	.438	8436 H1L5 PTFE	LUP	N/P
2.750	4.125	.438	8436 H5L16	LUP	FKM
2.750	4.125	.438	8436 H5L16	LUP	FKM
2.750	4.125	.563	12728 H1L5	LUPW	NBR
2.750	4.249	.625	8857 H1L5	LPD	NBR
2.750	4.249	.625	8857 H5L16	LPD	FKM
2.750	4.250	.531	16049 446	SSW	FAB
2.750	4.250	.531	16049 H1L5	SSW	NBR
2.751	3.537	.393	19577 H1L5	RUP	NBR
2.756	3.228	.354	14711 H1L7	P	NBR
2.756	3.543	.394	15297 H1L5	LPD	NBR
2.756	3.543	.394	15297 H1L5 PTFE	LPD	N/P
2.756	3.543	.394	15297 H5L16	LPD	FKM
2.756	3.543	.394	15318 H1L5	RPD	NBR
2.756	3.543	.394	15318 H5L16	RPD	FKM
2.756	3.543	.433	14097 H1L7	P	NBR

See Section 4 for seal type description. For High Misalignment sizes, see Page B-86. For FlexiSeal Listings, see Pages B-93 and B-97.

03/03/06



Shaft Dia.	Bore Dia.	Seal Width	Parker Part Number	Seal Type	Material
2.756	3.688	.259	10717 414	DS	CR
2.756	3.938	.470	14694 H1L5	LPD	NBR
2.756	3.938	.470	14694 H5L16	LPD	FKM
2.762	3.481	.375	TMAS 3481-2423	TMAS	PTFE
2.781	3.623	.375	5368 H1L7	SS	NBR
2.781	3.751	.500	10157 H1L5	LPDW	NBR
2.782	3.782	.438	0278 9373	SPLIT	NBR
2.782	3.782	.500	0278 9370	SPLIT	NBR
2.782	4.032	.500	0278 4314	SPLIT	NBR
2.813	3.500	.375	0281 5684	SPLIT	NBR
2.813	3.563	.375	0281 8472	SPLIT	NBR
2.813	3.563	.438	0281 4268	SPLIT	NBR
2.813	3.688	.313	9667 H1L5	RPD	NBR
2.813	3.751	.500	11558 H1L5	LUP	NBR
2.813	3.751	.500	11558 H1L5 PTFE	LUP	N/P
2.813	3.751	.500	11558 H5L16	LUP	FKM
2.813	3.813	.500	10230 H1L5	RUP	NBR
2.813	3.813	.500	10230 H1L7	RUP	NBR
2.813	3.813	.500	10230 H5L16	RUP	FKM
2.813	3.813	.500	0281 9370	SPLIT	NBR
2.813	3.875	.375	0502 LDN 531 02813 375 VN	LDN	PTFE
2.813	3.875	.375	2813-3875-375ETBN	TB	NBR
2.813	3.875	.438	0281 10168	SPLIT	NBR
2.813	3.876	.469	11148 H1L5	LPD	NBR
2.813	3.876	.469	11148 H5L16	LPD	FKM
2.813	3.938	.469	9386 H1L5	RPD	NBR
2.813	3.938	.469	9386 H5L16	RPD	FKM
2.813	4.000	.500	12347 H1L5	LPDW	NBR
2.813	4.003	.375	0502 LDN 595 02813 375 VN	LDN	PTFE
2.813	4.003	.375	2813-4003-375ETBN	TB	NBR
2.813	4.003	.431	18778 H1L5	LUP	NBR
2.813	4.125	.438	5871 H1L5	R	NBR
2.813	4.250	.281	10646 414	DS	CR
2.813	4.250	.375	0502 LDN 719 02813 375 VN	LDN	PTFE
2.813	4.250	.375	2813-4250-375ETBN	TB	NBR
2.835	3.740	.394	15325 H1L5	RPD	NBR
2.835	3.740	.394	15325 H5L89	RPD	FKM
2.844	3.594	.375	0284 8472	SPLIT	NBR
2.844	3.844	.500	0284 9370	SPLIT	NBR
2.844	3.938	.500	12553 H1L5	LPD	NBR
2.844	3.969	.500	0284 3706	SPLIT	NBR
2.844	4.094	.500	0284 4314	SPLIT	NBR
2.845	4.100	.563	0284 3939	SPLIT	NBR
2.850	3.750	.500	10528 H1L5	LPD	NBR
2.850	3.750	.500	10528 HL15	LPD	NBR
2.863	4.724	.500	3992 H1L5	LPD	NBR
2.863	4.724	.500	3992 H1L5 PTFE	LPD	N/P
2.863	4.724	.500	3992 H5L16	LPD	FKM
2.874	3.858	.591	19509 H1L5	RUP	NBR
2.875	3.375	.313	11604 H1L5	RPD	NBR
2.875	3.495	.375	0287 14525	SPLIT	NBR
2.875	3.500	.313	3631 H1L5	LPD	NBR
2.875	3.500	.313	3631 H5L16	LPD	FKM
2.875	3.500	.313	18235 H1L5	RUP	NBR
2.875	3.500	.313	18235 H5L16	RUP	FKM
2.875	3.500	.313	18235 HL15	RUP	NBR
2.875	3.500	.375	16694 5066	HP	FKM
2.875	3.500	.375	16694 5066 304	HP	FKM
2.875	3.500	.375	16694 5066 316	HP	FKM
2.875	3.500	.375	10209 H1L5	LPD	NBR
2.875	3.623	.375	0502 LDN 374 02875 375 VN	LDN	PTFE
2.875	3.623	.375	2875-3623-375ETBN	TB	NBR
2.875	3.625	.375	13137 H1L5	LPDW	NBR
2.875	3.625	.375	10065 H1L5	LUP	NBR
2.875	3.625	.375	10065 H5L89PTFE	LUP	F/P
2.875	3.625	.375	0287 8472	SPLIT	NBR

Shaft Dia.	Bore Dia.	Seal Width	Parker Part Number	Seal Type	Material
2.875	3.625	.438	17731 H1L5	LDS	NBR
2.875	3.625	.438	17731 H5L89	LDS	FKM
2.875	3.625	.438	10165 H1L5	LPD	NBR
2.875	3.625	.438	10165 H5L16	LPD	FKM
2.875	3.625	.438	0287 4268	SPLIT	NBR
2.875	3.625	.438	6042 H1L7	SS	NBR
2.875	3.668	.483	17472 H1L5	RUP	NBR
2.875	3.750	.375	10004 H1L5	LPD	NBR
2.875	3.750	.375	10004 H5L16	LPD	FKM
2.875	3.750	.375	TMAL 3750-2428	TMAL	PTFE
2.875	3.750	.438	10097 H1L5	LUP	NBR
2.875	3.750	.438	10097 H1L5 PTFE	LUP	N/P
2.875	3.750	.438	10097 H5L16	LUP	FKM
2.875	3.750	.438	10097 H5L16	LUP	FKM
2.875	3.750	.438	10097 HL15	LUP	NBR
2.875	3.750	.438	4053 H1L5	RPD	NBR
2.875	3.750	.438	4053 H5L16	RPD	FKM
2.875	3.750	.438	4053 HL15	RPD	NBR
2.875	3.750	.500	0287 12400	SPLIT	NBR
2.875	3.750	.500	0287 12400 V	SPLIT	FKM
2.875	3.750	.500	TMAL 3750-3228	TMAL	PTFE
2.875	3.750	.500	TMAS 3750-3228	TMAS	PTFE
2.875	3.751	.500	13553 H1L5	LPD	NBR
2.875	3.751	.500	13553 H5L16	LPD	FKM
2.875	3.752	.500	12496 H1L5	LPDW	NBR
2.875	3.758	.500	9876 H1L5	LPD	NBR
2.875	3.758	.500	9876 H5L16	LPD	FKM
2.875	3.875	.275	13522 H1L5	SDS	NBR
2.875	3.875	.375	11780 H1L5	LUP	NBR
2.875	3.875	.375	11780 H5L16	LUP	FKM
2.875	3.875	.375	16390 H1L5	RUP	NBR
2.875	3.875	.375	16390 H5L16	RUP	FKM
2.875	3.875	.438	6895 H1L5	RPD	NBR
2.875	3.875	.438	6895 H5L16	RPD	FKM
2.875	3.875	.438	0287 9373	SPLIT	NBR
2.875	3.875	.438	0287 9373 V	SPLIT	FKM
2.875	3.875	.500	0287 9370	SPLIT	NBR
2.875	3.875	.500	TMAL 3875-3232	TMAL	PTFE
2.875	3.876	.250	2875-3876-250EVBN	VB	NBR
2.875	3.938	.438	0287 10168	SPLIT	NBR
2.875	3.938	.500	0287 7036	SPLIT	NBR
2.875	4.000	.469	9488 H1L5	LUP	NBR
2.875	4.000	.469	9488 H1L5 PTFE	LUP	N/P
2.875	4.000	.469	9488 H5L16	LUP	FKM
2.875	4.000	.469	9488 HL15	LUP	NBR
2.875	4.000	.500	0287 3706	SPLIT	NBR
2.875	4.003	.375	0502 LDN 564 02875 375 VN	LDN	PTFE
2.875	4.003	.438	2875-4003-438ETBN	TB	NBR
2.875	4.003	.500	4107 H1L5	RUP	NBR
2.875	4.003	.500	4107 H5L16	RUP	FKM
2.875	4.003	.500	4107 HL15	RUP	NBR
2.875	4.007	.375	10087 H1L5	LPD	NBR
2.875	4.007	.375	10087 H5L16	LPD	FKM
2.875	4.120	.375	0287 11623	SPLIT	NBR
2.875	4.125	.375	0502 LDN 625 02875 375 VN	LDN	PTFE
2.875	4.125	.375	9918 H1L5	LUP	NBR
2.875	4.125	.375	9918 H5L16	LUP	FKM
2.875	4.125	.375	2875-4125-375ETBN	TB	NBR
2.875	4.125	.500	0287 4314	SPLIT	NBR
2.875	4.125	.500	0287 4314 V	SPLIT	FKM
2.875	4.125	.500	12499 H1L5	SSW	NBR
2.875	4.130	.563	0287 3939	SPLIT	NBR
2.875	4.130	.563	0287 3939 V	SPLIT	FKM
2.875	4.250	.500	0287 14748	SPLIT	NBR
2.875	4.250	.500	16044 H1L5	SSW	NBR
2.875	4.250	.500	16044 H5L16	SSW	FKM

See **Section 4** for seal type description. For High Misalignment sizes, see **Page B-86**.
For FlexiSeal Listings, see **Pages B-93** and **B-97**.

03/03/06



B

Shaft Dia.	Bore Dia.	Seal Width	Parker Part Number	Seal Type	Material
2.875	4.332	.500	5956 H1L5	LA	NBR
2.875	4.375	.500	0287 4790	SPLIT	NBR
2.875	5.118	.500	10192 H1L5	LPD	NBR
2.875	5.118	.500	10192 H1L5 PTFE	LPD	N/P
2.890	3.890	.438	0289 9373	SPLIT	NBR
2.901	3.601	.232	10319 H1L5	LUP	NBR
2.901	3.601	.232	10319 H5L16	LUP	FKM
2.901	3.601	.232	10319 H5MX5489	LUP	FKM
2.901	3.601	.232	10319 HL15	LUP	NBR
2.902	3.914	.325	13238 ALLL5	LUPW	NBR
2.905	4.528	.375	13678 H1L5	LDS	NBR
2.905	4.528	.375	13678 H5L16	LDS	FKM
2.906	3.875	.500	0289 8918	SPLIT	NBR
2.906	3.907	.438	0290 9373	SPLIT	NBR
2.906	3.969	.438	0290 10168	SPLIT	NBR
2.930	4.000	.500	13715 H1L5	LDSW	NBR
2.932	3.500	.312	15478 ALLL16	MP	FKM
2.933	3.469	.250	5039 414	DS	CR
2.937	3.628	.500	17168 H1L5	LUP	NBR
2.937	3.628	.500	17168 H5L16	LUP	FKM
2.937	4.000	.500	TMAL 4000-3234	TMAL	PTFE
2.938	3.623	.375	0502 LDN 343 02938 375 VN	LDN	PTFE
2.938	3.623	.375	2938-3623-375ETBN	TB	NBR
2.938	3.625	.344	16381 5066	HP	FKM
2.938	3.625	.344	16381 5066 304	HP	FKM
2.938	3.625	.344	16381 5066 316	HP	FKM
2.938	3.625	.375	9672 H1L5	LPD	NBR
2.938	3.625	.375	9672 H5L16	LPD	FKM
2.938	3.625	.375	5684 H1L5	RPD	NBR
2.938	3.625	.375	5684 H5L16	RPD	FKM
2.938	3.625	.375	0293 15162	SPLIT	NBR
2.938	3.687	.375	0293 8472	SPLIT	NBR
2.938	3.687	.375	0293 8472 V	SPLIT	FKM
2.938	3.688	.313	15779 H1L5	LPD	NBR
2.938	3.688	.437	TMAL 3688-2824	TMAL	PTFE
2.938	3.688	.438	0293 4533	SPLIT	NBR
2.938	3.750	.375	6108 H1L5	LUP	NBR
2.938	3.750	.375	6108 H5L16	LUP	FKM
2.938	3.750	.500	5464 H1L70	RUP	NBR
2.938	3.751	.375	0502 LDN 407 02938 375 VN	LDN	PTFE
2.938	3.751	.375	2938-3751-375ETBN	TB	NBR
2.938	3.751	.500	5464 H1L5	RUP	NBR
2.938	3.751	.500	5464 H5L16	RUP	FKM
2.938	3.813	.500	0293 12400	SPLIT	NBR
2.938	3.875	.375	0502 LDN 469 02938 375 VN	LDN	PTFE
2.938	3.875	.375	2938-3875-375ETBN	TB	NBR
2.938	3.875	.438	0293 4225	SPLIT	NBR
2.938	3.875	.500	11308 H1L5	LPD	NBR
2.938	3.875	.500	11308 H1L5 PTFE	LPD	N/P
2.938	3.907	.500	0293 8918	SPLIT	NBR
2.938	3.937	.500	0293 4289	SPLIT	NBR
2.938	3.938	.375	0502 LDN 500 02938 375 VN	LDN	PTFE
2.938	3.938	.375	2938-3938-375ETBN	TB	NBR
2.938	3.938	.438	0293 9373	SPLIT	NBR
2.938	3.938	.438	0293 9373 V	SPLIT	FKM
2.938	3.938	.500	15174 H1L5	LPD	NBR
2.938	3.938	.500	15174 H5L16	LPD	FKM
2.938	3.938	.500	4183 H1L5	LPD	NBR
2.938	3.938	.500	4183 H1L5 PTFE	LPD	N/P
2.938	3.938	.500	4183 H5L16	LPD	FKM
2.938	3.938	.500	11216 H1L5	OLLPD	NBR
2.938	3.938	.500	11216 H5MX5489	OLLPD	FKM
2.938	3.995	.375	0293 5667	SPLIT	NBR
2.938	4.000	.250	9088 414	DS	CR
2.938	4.000	.438	0293 10168	SPLIT	NBR
2.938	4.000	.438	13472 H1L5	LPD	NBR

Shaft Dia.	Bore Dia.	Seal Width	Parker Part Number	Seal Type	Material
2.938	4.000	.438	13472 H5L16	LPD	FKM
2.938	4.000	.500	9543 H1L3	LUP	CR
2.938	4.000	.500	9543 H1L5	LUP	NBR
2.938	4.000	.500	9543 H5L16	LUP	FKM
2.938	4.000	.500	0293 7036	SPLIT	NBR
2.938	4.000	.500	0293 7036 V	SPLIT	FKM
2.938	4.003	.375	5770 H1L5	LUP	NBR
2.938	4.003	.375	5770 H1L5 PTFE	LUP	N/P
2.938	4.003	.375	5770 H5L16 PTFE	LUP	F/P
2.938	4.003	.375	0502 LDN 533 02938 375 VN	LDN	PTFE
2.938	4.003	.438	2938-4003-438ETBN	TB	NBR
2.938	4.003	.500	9815 H1L5	LPD	NBR
2.938	4.003	.500	9815 H5L16	LPD	FKM
2.938	4.003	.625	18418 H1L5	LUP	NBR
2.938	4.008	.469	6041 H1L5	LA	NBR
2.938	4.063	.500	0293 3706	SPLIT	NBR
2.938	4.119	.472	0293 15319	SPLIT	NBR
2.938	4.125	.563	13954 H1L5	LPD	NBR
2.938	4.125	.563	13954 H5L16	LPD	FKM
2.938	4.188	.500	0293 4564	SPLIT	NBR
2.938	4.438	.500	0293 4790	SPLIT	NBR
2.938	4.500	.375	0502 LDN 781 02938 375 VN	LDN	PTFE
2.938	4.500	.438	2938-4500-438ETBN	TB	NBR
2.938	4.500	.469	9707 H1L5	LPD	NBR
2.938	4.500	.469	9707 H5L16	LPD	FKM
2.938	4.940	.350	20537 H1L5	SSW	NBR
2.938	4.999	.468	0293 8985	SPLIT	NBR
2.938	7.125	.813	16858 ALLL7	SSW	NBR
2.939	3.689	.375	0294 8472 V	SPLIT	FKM
2.940	3.689	.375	0294 8472	SPLIT	NBR
2.947	4.010	.500	TMAL 4010-3234	TMAL	PTFE
2.947	4.528	.500	13747 H1L5	LDS	NBR
2.948	4.528	.375	11716 H1L5	LDS	NBR
2.950	3.481	.375	12725 H1L5	LPD	NBR
2.950	3.481	.375	12725 H5MX5489	LPD	FKM
2.952	6.299	.375	15479 H1L5	LPD	NBR
2.953	3.740	.433	13572 H1L7	P	NBR
2.953	3.740	.472	30190 H5L16PTFE	RUP	F/P
2.953	3.938	.394	15089 H1L5	LPD	NBR
2.953	3.938	.394	15089 H5L16	LPD	FKM
2.953	4.000	.313	18028 H1L5	SSW	NBR
2.953	4.175	.500	19335 H1L5	LDS	NBR
2.953	4.175	.500	19484 H1L5	LDS	NBR
2.953	4.175	.500	19484 H5L89	LDS	FKM
2.953	4.528	.375	11292 H1L5	LPD	NBR
2.953	4.528	.375	11292 H1L5 PTFE	LPD	N/P
2.953	4.528	.375	11292 H5L16	LPD	FKM
2.953	4.724	.551	13979 H1L5	SSW	NBR
2.969	3.719	.375	0296 4381	SPLIT	NBR
2.969	3.719	.438	0296 4533	SPLIT	NBR
2.969	3.750	.375	9399 H1L5	LPD	NBR
2.969	3.938	.500	0296 8918	SPLIT	NBR
2.969	4.032	.500	0296 7036	SPLIT	NBR
2.969	4.094	.500	0296 3706	SPLIT	NBR
2.984	4.250	.500	10759 H1L5	RPD	NBR
2.990	4.000	.500	9998 H1L5	LPD	NBR
2.990	4.245	.563	0299 3939	SPLIT	NBR
2.998	4.004	.438	12652 H1L5	LPDW	NBR
3.000	3.375	.109	17302 ALLL7	H	NBR
3.000	3.442	.344	12322 ALLL7	P	NBR
3.000	3.442	.344	15748 H1L7	P	NBR
3.000	3.500	.250	19126 H1L7	SS	NBR
3.000	3.625	.375	14525 H1L5	RPD	NBR
3.000	3.625	.375	14525 H5L16	RPD	FKM
3.000	3.688	.438	0300 8967	SPLIT	NBR
3.000	3.750	.250	11977 H1L5	SSW	NBR

See Section 4 for seal type description. For High Misalignment sizes, see Page B-86. For FlexiSeal Listings, see Pages B-93 and B-97.

03/03/06



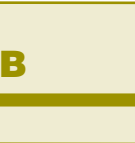

Shaft Dia.	Bore Dia.	Seal Width	Parker Part Number	Seal Type	Material
3.000	3.750	.250	17013 H1L20	SSW	XNBR
3.000	3.750	.250	17013 H1L5	SSW	NBR
3.000	3.750	.313	0300 9378	SPLIT	NBR
3.000	3.750	.375	16698 5066	HP	FKM
3.000	3.750	.375	16698 5066 304	HP	FKM
3.000	3.750	.375	16698 5066 316	HP	FKM
3.000	3.750	.375	0502 LDN 375 03000 375 VN	LDN	PTFE
3.000	3.750	.375	17797 H1L5	LPD	NBR
3.000	3.750	.375	17797 H1L70	LPD	NBR
3.000	3.750	.375	17797 H5L16	LPD	FKM
3.000	3.750	.375	10902 H1L5	LPDW	NBR
3.000	3.750	.375	5961 H1L20 PTFE	LUP	XN/P
3.000	3.750	.375	5961 H1L21 PTFE	LUP	EPDM
3.000	3.750	.375	5961 H1L5	LUP	NBR
3.000	3.750	.375	5961 H1L50	LUP	NBR
3.000	3.750	.375	5961 H1L7	LUP	NBR
3.000	3.750	.375	5961 H1L70 PTFE	LUP	NBR
3.000	3.750	.375	5961 H5L16	LUP	FKM
3.000	3.750	.375	0300 19606 V	SPLIT	FKM
3.000	3.750	.375	0300 4381	SPLIT	NBR
3.000	3.750	.375	0300 4912	SPLIT	NBR
3.000	3.750	.375	0300 9215	SPLIT	NBR
3.000	3.750	.375	0300 9215 V	SPLIT	FKM
3.000	3.750	.375	TMAL 3750-2424	TMAL	PTFE
3.000	3.750	.410	12109 ALLL7	P	NBR
3.000	3.750	.410	12109 H5L16	P	FKM
3.000	3.750	.438	0300 4533	SPLIT	NBR
3.000	3.750	.438	4268 H1L5	RPD	NBR
3.000	3.750	.438	4268 H5L16	RPD	FKM
3.000	3.751	.375	3000-3751-375ETBN	TB	NBR
3.000	3.751	.438	13414 H1L2160	LUP	EPDM
3.000	3.751	.438	13414 H1L5	LUP	NBR
3.000	3.751	.438	13414 H5L16	LUP	FKM
3.000	3.813	.375	11777 412	DS	CR
3.000	3.813	.375	11777 414	DS	CR
3.000	3.875	.375	0502 LDN 438 03000 375 VN	LDN	PTFE
3.000	3.875	.438	3000-3875-438ETBN	TB	NBR
3.000	3.875	.500	15153 H1L5	LPD	NBR
3.000	3.875	.500	15153 H1L5 PTFE	LPD	N/P
3.000	3.875	.500	15153 H5MX5489	LPD	FKM
3.000	3.875	.500	0300 12400	SPLIT	NBR
3.000	3.875	.500	TMAL 3875-3228	TMAL	PTFE
3.000	3.935	.375	14511 H1L5	LUP	NBR
3.000	3.935	.375	14511 H5L16	LUP	FKM
3.000	3.938	.438	0300 4225	SPLIT	NBR
3.000	3.969	.500	0300 8918	SPLIT	NBR
3.000	4.000	.250	19604 H1L5	SPC	NBR
3.000	4.000	.250	19604 H1L70	MISC	NBR
3.000	4.000	.375	9182 H1L5	LUP	NBR
3.000	4.000	.375	9182 H1L5 PTFE	LUP	N/P
3.000	4.000	.375	9182 H5L16	LUP	FKM
3.000	4.000	.375	9182 H5L16 PTFE	LUP	F/P
3.000	4.000	.375	TMAL 4000-2432	TMAL	PTFE
3.000	4.000	.438	3640 H1L5	B	NBR
3.000	4.000	.438	17700 5066	HP	FKM
3.000	4.000	.438	17700 5066 304	HP	FKM
3.000	4.000	.438	17700 5066 316	HP	FKM
3.000	4.000	.438	5104 H1L21 SPEC	LPD	EPDM
3.000	4.000	.438	5104 H1L5	LPD	NBR
3.000	4.000	.438	5104 H5L16	LPD	FKM
3.000	4.000	.438	0300 9373	SPLIT	NBR
3.000	4.000	.438	0300 9373 L21	SPLIT	EPDM
3.000	4.000	.438	0300 9373 V	SPLIT	FKM
3.000	4.000	.500	4349 H1L5	B	NBR
3.000	4.000	.500	17816 H1L5	H	NBR
3.000	4.000	.500	10901 H1L5	LPDW	NBR

Shaft Dia.	Bore Dia.	Seal Width	Parker Part Number	Seal Type	Material
3.000	4.000	.500	10901 H1L70	LPDW	NBR
3.000	4.000	.500	9045 H1L2160	LUP	EPDM
3.000	4.000	.500	9045 H1L5	LUP	NBR
3.000	4.000	.500	9045 H1L5 PTFE	LUP	N/P
3.000	4.000	.500	9045 H1L7	LUP	NBR
3.000	4.000	.500	9045 H5L16	LUP	FKM
3.000	4.000	.500	9045 H5L16 PTFE	LUP	F/P
3.000	4.000	.500	16233 H1L5	LUPW	NBR
3.000	4.000	.500	9370 H1L20	RUP	XNBR
3.000	4.000	.500	9370 H1L5	RUP	NBR
3.000	4.000	.500	9370 H5L16	RUP	FKM
3.000	4.000	.500	0300 4289	SPLIT	NBR
3.000	4.000	.500	0300 4289 PS	SPLIT	NBR
3.000	4.000	.500	0300 4289 V	SPLIT	FKM
3.000	4.000	.500	0300 9724 V	SPLIT	FKM
3.000	4.000	.500	9343 H1L5 PTFE	SS	N/P
3.000	4.000	.500	9343 H1L7	SS	NBR
3.000	4.000	.500	9343 H1L7 PTFE	SS	N/P
3.000	4.000	.500	TMAL 4000-3232	TMAL	PTFE
3.000	4.000	.500	TMAS 4000-3232	TMAS	PTFE
3.000	4.000	.562	13773 H1L5	LDS	NBR
3.000	4.000	.562	13773 H5MX5489	LDS	FKM
3.000	4.000	.578	13804 H1L5	LPD	NBR
3.000	4.000	.625	0300 3976	SPLIT	NBR
3.000	4.000	.750	17032 H1L7	P	NBR
3.000	4.003	.375	0502 LDN 502 03000 375 VN	LDN	PTFE
3.000	4.003	.375	15910 H1L5	LDS	NBR
3.000	4.003	.375	15910 H5L16	LDS	FKM
3.000	4.003	.375	16743 H1L5	LPD	NBR
3.000	4.003	.375	16743 H1L5 PTFE	LPD	N/P
3.000	4.003	.375	16743 H5L16	LPD	FKM
3.000	4.003	.375	6423 H1L20	LUP	XNBR
3.000	4.003	.375	6423 H1L5	LUP	NBR
3.000	4.003	.375	6423 H1L5 PTFE	LUP	N/P
3.000	4.003	.375	6423 H5L16	LUP	FKM
3.000	4.003	.375	6423 H5L16 PTFE	LUP	F/P
3.000	4.003	.375	3000-4003-375ETBN	TB	NBR
3.000	4.003	.469	11074 H1L5	LPD	NBR
3.000	4.003	.469	11074 H5L16	LPD	FKM
3.000	4.003	.500	4940 H1L5	LA	NBR
3.000	4.003	.500	4940 H5L16	LA	FKM
3.000	4.063	.500	0300 7036	SPLIT	NBR
3.000	4.063	.438	0300 10168	SPLIT	NBR
3.000	4.125	.375	TMAL 4125-2436	TMAL	PTFE
3.000	4.125	.375	0502 LDN 563 03000 375 VN	LDN	PTFE
3.000	4.125	.438	10249 H1L5	LPD	NBR
3.000	4.125	.438	10249 H5L16	LPD	FKM
3.000	4.125	.438	3000-4125-438ETBN	TB	NBR
3.000	4.125	.500	15911 H1L5	LPDW	NBR
3.000	4.125	.500	0300 3706	SPLIT	NBR
3.000	4.125	.500	0300 4054	SPLIT	NBR
3.000	4.125	.563	15185 5066	HP	FKM
3.000	4.125	.563	15185 5066 304	HP	FKM
3.000	4.125	.563	15185 5066 316	HP	FKM
3.000	4.125	.563	12366 H1L5	LPD	NBR
3.000	4.130	.500	9368 H1L5	LPD	NBR
3.000	4.249	.375	0502 LDN 625 03000 375 VN	LDN	PTFE
3.000	4.249	.438	3000-4249-438ETBN	TB	NBR
3.000	4.249	.500	11830 H1L5	LUP	NBR
3.000	4.249	.500	11830 H5L16	LUP	FKM
3.000	4.250	.500	0300 4564	SPLIT	NBR
3.000	4.250	.500	4314 H1L5	RUP	NBR
3.000	4.250	.500	4314 H5L16	RUP	FKM
3.000	4.250	.563	14375 H1L5	LDS	NBR
3.000	4.250	.625	6073 H1L5	LUP	NBR
3.000	4.250	.625	6073 H5L16	LUP	FKM

See Section 4 for seal type description. For High Misalignment sizes, see Page B-86.
For FlexiSeal Listings, see Pages B-93 and B-97.

03/03/06



B

Shaft Dia.	Bore Dia.	Seal Width	Parker Part Number	Seal Type	Material
3.000	4.250	.625	0300 9272	SPLIT	NBR
3.000	4.250	.625	0300 9272 V	SPLIT	FKM
3.000	4.255	.563	0300 3939	SPLIT	NBR
3.000	4.375	.375	0502 LDN 688 03000 375 VN	LDN	PTFE
3.000	4.375	.438	3000-4375-438ETBN	TB	NBR
3.000	4.375	.500	0300 14748	SPLIT	NBR
3.000	4.375	.563	8506 H1L5	LPD	NBR
3.000	4.375	.563	8506 H1L5 PTFE	LPD	N/P
3.000	4.375	.563	8506 H5L16	LPD	FKM
3.000	4.375	.625	8507 H1L5	LUP	NBR
3.000	4.500	.375	0502 LDN 750 03000 375 VN	LDN	PTFE
3.000	4.500	.438	3000-4500-438ETBN	TB	NBR
3.000	4.500	.500	4360 H1L5	LPD	NBR
3.000	4.500	.500	4360 H1L70	LPD	NBR
3.000	4.500	.500	4360 H5L16	LPD	FKM
3.000	4.500	.500	0300 4790	SPLIT	NBR
3.000	4.500	.500	0300 4790 V	SPLIT	FKM
3.000	4.500	.500	18173 H1L5	SSW	NBR
3.000	4.500	.688	19291 412	DS	CR
3.000	4.730	.500	15632 H1L3	LUP	CR
3.000	4.730	.500	15632 H1L5	LUP	NBR
3.000	4.730	.500	15632 H5L16	LUP	FKM
3.000	4.750	.438	15581 ALLL5	SPC	NBR
3.000	5.000	.500	9004 H1L5	LPD	NBR
3.000	5.000	.500	9004 H5L16	LPD	FKM
3.000	5.006	.468	0300 8985	SPLIT	NBR
3.000	5.118	.625	14055 H1L5	LUPW	NBR
3.000	5.512	.625	14056 H1L5	LUPW	NBR
3.002	4.250	.500	13389 H1L5	SSW	NBR
3.031	3.782	.375	0303 4381	SPLIT	NBR
3.040	3.500	.250	19594 H1L7	SS	NBR
3.040	3.500	.250	19594 H5L16	SS	FKM
3.063	3.188	.375	8472 H1L5	RUP	NBR
3.063	3.188	.375	8472 H5L16	RUP	FKM
3.063	3.750	.375	15162 H1L5	RPD	NBR
3.063	3.750	.375	15162 H5L16	RPD	FKM
3.063	3.750	.438	0306 8967	SPLIT	NBR
3.063	3.813	.375	18523 H1L5	LUP	NBR
3.063	3.813	.375	18523 H5L16	LUP	FKM
3.063	3.813	.375	0306 4381	SPLIT	NBR
3.063	3.813	.375	0306 9215	SPLIT	NBR
3.063	3.938	.500	0306 12400	SPLIT	NBR
3.063	4.062	.507	16010 H1L5	LUPW	NBR
3.063	4.063	.500	0306 4289	SPLIT	NBR
3.063	4.125	.375	5667 H1L5	RPD	NBR
3.063	4.125	.375	5667 H5L16	RPD	FKM
3.063	4.125	.438	10168 H1L5	RPD	NBR
3.063	4.125	.500	0306 7036	SPLIT	NBR
3.063	4.188	.500	0306 4054	SPLIT	NBR
3.063	4.250	.500	10960 H1L5	LPD	NBR
3.063	4.250	.500	10960 H5L16	LPD	FKM
3.063	4.250	.625	11039 H1L5	LPD	NBR
3.063	4.250	.500	0306 10232	SPLIT	NBR
3.063	4.313	.500	0306 4564	SPLIT	NBR
3.063	4.500	.469	16538 H1L5	LUP	NBR
3.063	4.527	.500	17132 H1L5	LDS	NBR
3.063	4.527	.500	17132 H5L16	LDS	FKM
3.063	4.527	.500	60017 H1L5	LDS	NBR
3.063	4.527	.500	60017 H1MX9508	LDS	HNBR
3.063	4.625	.469	0306 4275	SPLIT	NBR
3.065	4.125	.563	5825 H1L5	LUP	NBR
3.065	4.125	.563	5825 H5L16	LUP	FKM
3.066	4.500	.500	18417 H1L5	SSW	NBR
3.094	3.844	.375	18112 5066	HP	FKM
3.094	3.844	.375	18112 5066 304	HP	FKM
3.094	3.844	.375	18112 5066 316	HP	FKM

Shaft Dia.	Bore Dia.	Seal Width	Parker Part Number	Seal Type	Material
3.094	4.063	.500	0309 8918	SPLIT	NBR
3.094	4.094	.500	0309 4289	SPLIT	NBR
3.114	4.250	.375	70005 H1L5	TSS	NBR
3.115	4.250	.344	11606 H1L7	SS	NBR
3.120	3.881	.250	19732 H1L5	SS	NBR
3.120	4.120	.625	0312 3976	SPLIT	NBR
3.120	4.922	.625	5766 H1L5	LPD	NBR
3.120	4.922	.625	5766 H5L16	LPD	FKM
3.125	3.875	.313	0312 9378	SPLIT	NBR
3.125	3.875	.375	17181 5066	HP	FKM
3.125	3.875	.375	17181 5066 304	HP	FKM
3.125	3.875	.375	17181 5066 316	HP	FKM
3.125	3.875	.375	17181 SPEC	HP	FKM
3.125	3.875	.375	10434 H1L5	LPD	NBR
3.125	3.875	.375	10434 H5L16	LPD	FKM
3.125	3.875	.375	15164 H1L20	LPDW	XNBR
3.125	3.875	.375	15164 H1L5	LPDW	NBR
3.125	3.875	.375	15164 H5MX5489	LPDW	FKM
3.125	3.875	.375	19390	MP	FKM
3.125	3.875	.375	0312 4381	SPLIT	NBR
3.125	3.875	.438	0312 9728	SPLIT	NBR
3.125	3.875	.438	4533 H1L5	RPD	NBR
3.125	3.875	.438	4533 H5L16	RPD	FKM
3.125	4.000	.375	0312 9215	SPLIT	NBR
3.125	4.000	.469	16606 H1L7	H	NBR
3.125	4.000	.469	17950 H1L5	LDS	NBR
3.125	4.000	.500	0312 12400	SPLIT	NBR
3.125	4.003	.375	0502 LDN 439 03125 375 VN	LDN	PTFE
3.125	4.003	.438	3125-4003-438ETBN	TB	NBR
3.125	4.094	.500	19073 H1L5	RPD	NBR
3.125	4.094	.500	0312 8918	SPLIT	NBR
3.125	4.120	.500	0312 4794	SPLIT	NBR
3.125	4.125	.375	0502 LDN 500 03125 375 VN	LDN	PTFE
3.125	4.125	.375	3125-4125-375ETBN	TB	NBR
3.125	4.125	.438	9373 H1L2160	RPD	EPDM
3.125	4.125	.438	9373 H1L5	RPD	NBR
3.125	4.125	.438	9373 H5L16	RPD	FKM
3.125	4.125	.500	0312 4289	SPLIT	NBR
3.125	4.125	.500	0312 4289 V	SPLIT	FKM
3.125	4.125	.500	0312 9724	SPLIT	NBR
3.125	4.125	.500	8957 H1L5	OLR	NBR
3.125	4.125	.500	5011 H1L5	LUP	NBR
3.125	4.125	.500	5011 H1L5 PTFE	LUP	N/P
3.125	4.125	.500	5011 H5L16	LUP	FKM
3.125	4.125	.500	3830 H1L5	B	NBR
3.125	4.125	.563	13518 H1L5	LDS	NBR
3.125	4.125	.563	13518 H1L7	LDS	NBR
3.125	4.125	.563	13518 H5L16	LDS	FKM
3.125	4.125	.625	0312 3976 V	SPLIT	FKM
3.125	4.188	.500	0312 11083	SPLIT	NBR
3.125	4.250	.375	0502 LDN 563 03125 375 VN	LDN	PTFE
3.125	4.250	.375	0312 15332	SPLIT	NBR
3.125	4.250	.375	3125-4250-375ETBN	TB	NBR
3.125	4.250	.500	17778 H1L5	LDS	NBR
3.125	4.250	.500	3706 H1L5	RPD	NBR
3.125	4.250	.500	3706 H5MX5489	RPD	FKM
3.125	4.250	.500	0312 4054	SPLIT	NBR
3.125	4.250	.563	0312 10148	SPLIT	NBR
3.125	4.250	.563	0312 10148 V	SPLIT	FKM
3.125	4.251	.625	9092 H1L5	LPD	NBR
3.125	4.251	.625	9092 H5L16	LPD	FKM
3.125	4.313	.500	0312 10232	SPLIT	NBR
3.125	4.375	.500	0312 4564	SPLIT	NBR
3.125	4.375	.625	15925 5066	HP	FKM
3.125	4.375	.625	15925 5066 304	HP	FKM
3.125	4.375	.625	15925 5066 316	HP	FKM

See Section 4 for seal type description. For High Misalignment sizes, see Page B-86. For FlexiSeal Listings, see Pages B-93 and B-97.

03/03/06



B

Shaft Dia.	Bore Dia.	Seal Width	Parker Part Number	Seal Type	Material
3.125	4.375	.625	11685 H1L5	LPD	NBR
3.125	4.375	.625	11685 H1L5 PTFE	LPD	N/P
3.125	4.375	.625	11685 H5L16	LPD	FKM
3.125	4.375	.625	11685 H5L16	LPD	FKM
3.125	4.375	.625	0312 9272	SPLIT	NBR
3.125	4.380	.563	3939 H1L5	RPD	NBR
3.125	4.380	.563	3939 H5L16	RPD	FKM
3.125	4.500	.375	0502 LDN 688 03125 375 VN	LDN	PTFE
3.125	4.500	.375	19537 H1L7	H	NBR
3.125	4.500	.375	3125-4500-375ETBN	TB	NBR
3.125	4.500	.375	TN 4500-2444	TN	N/P
3.125	4.500	.375	TNV 4500-2444	TN	N/P
3.125	4.500	.500	8509 H1L5	LUP	NBR
3.125	4.500	.500	8509 H5L16	LUP	FKM
3.125	4.500	.500	0312 14748	SPLIT	NBR
3.125	4.625	.625	10142 H1L5	LUP	NBR
3.125	4.625	.625	10142 H5L16	LUP	FKM
3.125	4.626	.375	0502 LDN 751 03125 375 VN	LDN	PTFE
3.125	4.626	.438	3125-4626-438ETAN	TA	NBR
3.125	4.750	.469	0312 5047	SPLIT	NBR
3.125	4.750	.625	15289 H1L5	LPD	NBR
3.125	4.750	.625	15289 H5L16	LPD	FKM
3.125	5.000	.500	6814 H1L5	LA	NBR
3.130	4.255	.563	0313 10148 V	SPLIT	FKM
3.131	4.313	.500	0331 7341	SPLIT	NBR
3.131	5.000	.469	9523 H1L5	LPD	NBR
3.133	4.866	1.122	19813 H1L5	OLSS-EL	NBR
3.134	4.134	.390	TMAL 4134-2532	TMAL	PTFE
3.142	4.203	.500	0314 11083	SPLIT	NBR
3.142	4.203	.500	0314 11083 V	SPLIT	FKM
3.148	3.880	.438	16868 H1L5	LDS	NBR
3.149	3.813	.375	12380 H1L5	RPD	NBR
3.149	3.813	.375	12380 H5L16	RPD	FKM
3.149	3.938	.393	14644 H1/EPDM	LPD	EPDM
3.149	3.938	.393	14644 H1L5	LPD	NBR
3.149	3.938	.393	14644 H1L70	LPD	NBR
3.149	3.938	.393	14644 H5L16	LPD	FKM
3.150	3.622	.354	14710 H1L5	P	NBR
3.150	3.622	.354	14710 H1L7	P	NBR
3.150	3.622	.354	14710 H5MX5489	P	FKM
3.150	3.938	.512	16432 H1L5	LUP	NBR
3.150	3.938	.512	16432 H5L16	LUP	FKM
3.150	4.125	.250	10716 414	DS	CR
3.150	4.134	.394	15329 H1L5	RPD	NBR
3.150	4.135	.472	0315 15321	SPLIT	NBR
3.150	4.331	.472	15319 H1L5	RPD	NBR
3.150	4.331	.472	15319 H5L16	RPD	FKM
3.150	4.528	.413	20778 5202	MP	FKM
3.156	3.907	.375	0315 4912	SPLIT	NBR
3.156	3.907	.438	0315 9728	RUP	NBR
3.156	3.938	.500	TMAL 3938-3225	TMAL	PTFE
3.156	4.125	.500	0315 8918	SPLIT	NBR
3.156	4.157	.500	0315 4289	SPLIT	NBR
3.156	4.209	.438	0315 4266	SPLIT	NBR
3.156	4.219	.500	0315 11083	SPLIT	NBR
3.156	4.250	.469	4801 H1L5	LUP	NBR
3.180	4.250	.378	19593 H1L7	H	NBR
3.187	4.250	.250	TMAL 4250-1634	TMAL	PTFE
3.188	3.937	.313	0318 9378	SPLIT	NBR
3.188	3.938	.375	0318 4912	SPLIT	NBR
3.188	3.938	.375	0318 9215	SPLIT	NBR
3.188	3.938	.438	0318 9728	SPLIT	NBR
3.188	4.000	.406	16346 H1L5	LUP	NBR
3.188	4.000	.406	16346 H5L16	LUP	FKM
3.188	4.000	.469	8484 H1L5	LPD	NBR
3.188	4.000	.469	8484 H5L16	LPD	FKM

Shaft Dia.	Bore Dia.	Seal Width	Parker Part Number	Seal Type	Material
3.188	4.188	.500	0318 4289	SPLIT	NBR
3.188	4.188	.500	0318 4289 V	SPLIT	FKM
3.188	4.250	.438	0318 4266	SPLIT	NBR
3.188	4.250	.500	19086 H1L5	LPD	NBR
3.188	4.250	.500	19086 H5L16	LPD	FKM
3.188	4.250	.500	7227 H1L5	LPD	NBR
3.188	4.250	.500	12872 H1L5	OLSS	NBR
3.188	4.250	.500	7036 H1L5	RUP	NBR
3.188	4.250	.500	7036 H5L16	RUP	FKM
3.188	4.250	.500	0318 11083	SPLIT	NBR
3.188	4.250	.531	18167 5066	HP	FKM
3.188	4.250	.563	10683 H1L5	OLRPD	NBR
3.188	4.250	.625	15235 H1L5	LPD	NBR
3.188	4.313	.375	0318 15332	SPLIT	NBR
3.188	4.375	.500	0318 10232	SPLIT	NBR
3.188	4.375	.500	9193 H1L5	LUP	NBR
3.188	4.375	.500	9193 H5L16	LUP	FKM
3.188	4.438	.625	0318 9272	SPLIT	NBR
3.188	4.500	.625	0318 9001	SPLIT	NBR
3.188	4.500	.625	8838 H1L5	LPD	NBR
3.188	4.750	.468	0318 9559	SPLIT	NBR
3.188	4.813	.469	0318 5047	SPLIT	NBR
3.188	5.000	.250	9087 414	DS	CR
3.188	5.000	.500	9542 H1L5	LPD	NBR
3.189	4.724	.551	15009 H1L5	SSW	NBR
3.190	4.190	.625	0319 3976	SPLIT	NBR
3.190	4.190	.625	0319 3976 V	SPLIT	FKM
3.200	4.000	.250	20424 MX5489	MP	FKM
3.219	3.969	.313	0321 9378	SPLIT	NBR
3.219	3.969	.375	0321 4912	SPLIT	NBR
3.219	3.969	.438	0321 9728	SPLIT	NBR
3.219	4.219	.500	0321 4289	SPLIT	NBR
3.219	4.844	.469	0321 5047	SPLIT	NBR
3.223	3.973	.438	0322 9728	SPLIT	NBR
3.228	3.938	.354	18762 5066	HP	FKM
3.239	3.980	.375	0323 4912	SPLIT	NBR
3.239	3.984	.375	0323 9215	SPLIT	NBR
3.239	4.000	.375	11150 H1L7	SS	NBR
3.239	4.000	.375	11150 H5L16	SS	FKM
3.239	4.250	.688	0323 14427	SPLIT	NBR
3.240	4.240	.500	0324 4289 V	SPLIT	FKM
3.240	4.490	.625	0324 9272 V	SPLIT	FKM
3.250	3.628	.188	19731 H1L5	SS	NBR
3.250	3.750	.250	17429 H1L7	SS	NBR
3.250	3.750	.250	17429 H1L7 PTFE	SS	N/P
3.250	4.000	.250	7202 414	DS	CR
3.250	4.000	.250	5027 H1L5	LUP	NBR
3.250	4.000	.250	5027 H1L5 PTFE	LUP	N/P
3.250	4.000	.250	5027 H1L50	LUP	NBR
3.250	4.000	.250	5027 H5L16	LUP	FKM
3.250	4.000	.313	10973 H1L5	LPDW	NBR
3.250	4.000	.313	0325 9378	SPLIT	NBR
3.250	4.000	.375	19606 H5L16	B	FKM
3.250	4.000	.375	6434 H1L5	B	NBR
3.250	4.000	.375	19479 H1L7	H	NBR
3.250	4.000	.375	17970 5066	HP	FKM
3.250	4.000	.375	17970 5066 304	HP	FKM
3.250	4.000	.375	17970 5066 316	HP	FKM
3.250	4.000	.375	0502 LDN 375 03250 375 VN	LDN	PTFE
3.250	4.000	.375	4381 H1L5	RPD	NBR
3.250	4.000	.375	4381 H1L7	RPD	NBR
3.250	4.000	.375	0325 4912	SPLIT	NBR
3.250	4.000	.375	0325 4912 V	SPLIT	FKM
3.250	4.000	.375	0325 9215	SPLIT	NBR
3.250	4.000	.375	0325 9215 V	SPLIT	FKM
3.250	4.000	.375	3250-4000-375ETBN	TB	NBR

See Section 4 for seal type description. For High Misalignment sizes, see Page B-86. For FlexiSeal Listings, see Pages B-93 and B-97.

03/03/06



B

Shaft Dia.	Bore Dia.	Seal Width	Parker Part Number	Seal Type	Material
3.250	4.000	.375	TN 4000-2424	TN	N/P
3.250	4.000	.375	TNV 4000-2424	TN	N/P
3.250	4.000	.438	10100 H1L20	LUP	XNBR
3.250	4.000	.438	10100 H1L5	LUP	NBR
3.250	4.000	.438	10100 H1L5 PTFE	LUP	N/P
3.250	4.000	.438	10100 H5L16	LUP	FKM
3.250	4.000	.438	10100 H5MX5489	LUP	FKM
3.250	4.000	.438	0325 9728	SPLIT	NBR
3.250	4.000	.438	0325 9728 V	SPLIT	FKM
3.250	4.000	.500	15436 ALLL7	P	NBR
3.250	4.003	.469	18099 H1L5	LUP	NBR
3.250	4.003	.469	18099 H5L16	LUP	FKM
3.250	4.125	.500	12400 H1L2160	RUP	EPDM
3.250	4.125	.500	12400 H1L5	RUP	NBR
3.250	4.125	.500	12400 H5L16	RUP	FKM
3.250	4.125	.562	TMAL 4125-3628	TMAL	PTFE
3.250	4.125	.563	16539 H1L5	LUP	NBR
3.250	4.156	.250	11494 414	DS	CR
3.250	4.249	.250	3250-4249-250EVB	VB	NBR
3.250	4.249	.375	0502 LDN 500 03250 375 VN	LDN	PTFE
3.250	4.249	.375	3250-4249-375ETBN	TB	NBR
3.250	4.250	.375	18939 H1L7	H	NBR
3.250	4.250	.375	19442 H1L7	H	NBR
3.250	4.250	.438	7190 H1L5	LUP	NBR
3.250	4.250	.438	7190 H1L5 PTFE	LUP	N/P
3.250	4.250	.438	7190 H1L70	LUP	NBR
3.250	4.250	.438	7190 H5L16	LUP	FKM
3.250	4.250	.500	4794 H1L5	B	NBR
3.250	4.250	.500	11764 H1L3	H	CR
3.250	4.250	.500	11764 H1L5	H	NBR
3.250	4.250	.500	11764 H1L7	H	NBR
3.250	4.250	.500	11764 H5L16	H	FKM
3.250	4.250	.500	18963 H1L5	H	NBR
3.250	4.250	.500	18963 H1L5	H	NBR
3.250	4.250	.500	12268 H1L5	LPDW	NBR
3.250	4.250	.500	9547 H1L5	LUP	NBR
3.250	4.250	.500	9547 H1L5 PTFE	LUP	N/P
3.250	4.250	.500	9547 H1L70	LUP	NBR
3.250	4.250	.500	9547 H1L70 PTFE	LUP	NBR
3.250	4.250	.500	9547 H5/MX5489	LUP	FKM
3.250	4.250	.500	9547 H5L16 PTFE	LUP	F/P
3.250	4.250	.500	9547 H5L16	LUP	FKM
3.250	4.250	.500	0325 4289	SPLIT	NBR
3.250	4.250	.500	0325 4289 V	SPLIT	FKM
3.250	4.250	.500	0325 7341	SPLIT	NBR
3.250	4.250	.500	0325 9724	SPLIT	NBR
3.250	4.250	.500	8845 H1L7	SS	NBR
3.250	4.250	.500	8845 H5L89	SS	FKM
3.250	4.250	.500	TMAL 4250-3232	TMAL	PTFE
3.250	4.250	.625	13241 H1L5	LDS	NBR
3.250	4.250	.625	13241 H5L16	LDS	FKM
3.250	4.250	.625	13241 H5MX5489	LDS	FKM
3.250	4.250	.625	11497 H1L5	LPD	NBR
3.250	4.250	.625	0325 3976	SPLIT	NBR
3.250	4.250	.625	0325 3976 V	SPLIT	FKM
3.250	4.250	.625	0325 9725	SPLIT	NBR
3.250	4.312	.438	0325 4266	SPLIT	NBR
3.250	4.312	.438	0325 4266 V	SPLIT	FKM
3.250	4.344	.500	19072 H1L5	RPD	NBR
3.250	4.375	.375	0325 15332	SPLIT	NBR
3.250	4.375	.375	0325 15332 V	SPLIT	FKM
3.250	4.375	.500	4054 H1L5	RUP	NBR
3.250	4.375	.500	4054 H5L16	RUP	FKM
3.250	4.375	.531	8483 H1L5	LPD	NBR
3.250	4.375	.531	8483 H5L16	LPD	FKM
3.250	4.375	.828	17972 H1L5	LDS	NBR

Shaft Dia.	Bore Dia.	Seal Width	Parker Part Number	Seal Type	Material
3.250	4.376	.625	6145 H1L5	LA	NBR
3.250	4.438	.500	0325 10232	SPLIT	NBR
3.250	4.495	.375	0325 11623	SPLIT	NBR
3.250	4.500	.250	0325 14939	SPLIT	NBR
3.250	4.500	.375	0502 LDN 625 03250 375 VN	LDN	PTFE
3.250	4.500	.375	3250-4500-375ETBN	TB	NBR
3.250	4.500	.438	17833 H1L5	LUPW	NBR
3.250	4.500	.500	13075 H1L5	LUP	NBR
3.250	4.500	.500	13075 H5L16	LUP	FKM
3.250	4.500	.500	19825	MP	FKM
3.250	4.500	.500	19825 2412	MP	FKM
3.250	4.500	.500	4564 H1L5	RPD	NBR
3.250	4.500	.500	4564 H5L16	RPD	FKM
3.250	4.500	.563	14271 H1L5	LPD	NBR
3.250	4.500	.563	14271 H1L5 PTFE	LPD	N/P
3.250	4.500	.563	14271 H5L16	LPD	FKM
3.250	4.500	.563	9014 H1L5	OLRPD	NBR
3.250	4.500	.625	12645 H1L5	LPDW	NBR
3.250	4.500	.625	12645 H5L16	LPDW	FKM
3.250	4.500	.625	10305 H1L5	LUP	NBR
3.250	4.500	.625	10305 H5L16	LUP	FKM
3.250	4.500	.625	0325 9272	SPLIT	NBR
3.250	4.500	.625	0325 9272 V	SPLIT	FKM
3.250	4.625	.468	0325 9763	SPLIT	NBR
3.250	4.625	.500	11121 H1L5	LPD	NBR
3.250	4.625	.500	11121 H5L16	LPD	FKM
3.250	4.625	.500	14748 H1L5	RPD	NBR
3.250	4.626	.375	0502 LDN 688 03250 375 VN	LDN	PTFE
3.250	4.626	.438	3250-4626-438ETAN	TA	NBR
3.250	4.719	.625	15887 H1L5	LDS	NBR
3.250	4.750	.375	0502 LDN 750 03250 375 VN	LDN	PTFE
3.250	4.750	.438	3250-4750-438ETBN	TB	NBR
3.250	4.750	.500	4790 H1L5	RPD	NBR
3.250	4.750	.625	17389 5066	HP	FKM
3.250	4.750	.625	17389 5066 304	HP	FKM
3.250	4.750	.625	17389 5066 316	HP	FKM
3.250	4.750	.625	16540 H1L5	LUP	NBR
3.250	4.750	.750	0325 7175	SPLIT	NBR
3.250	4.750	.750	9656 H1L5	RPD	NBR
3.250	4.813	.500	16785 H1L30	OLLUP	HNBR
3.250	4.813	.500	16785 H1L5	OLLUP	NBR
3.250	4.875	.469	0325 5047	SPLIT	NBR
3.250	4.875	.500	8839 H1L5	LPD	NBR
3.250	4.875	.500	8839 H5L16	LPD	FKM
3.250	5.000	.468	8945 H1L5	LUP	NBR
3.250	5.000	.468	8945 H1L70	LUP	NBR
3.250	5.000	.468	8945 H5MX5489	LUP	FKM
3.250	5.250	.500	10272 H1L5	LPD	NBR
3.250	5.255	.469	8985 H1L5	R	NBR
3.255	5.000	.281	9860 414	DS	CR
3.276	4.182	.500	TN 4182-3229	TN	N/P
3.276	4.182	.500	TNV 4182-3229	TN	N/P
3.281	4.250	.500	8918 H1L5	RUP	NBR
3.282	4.032	.375	0328 9215	SPLIT	NBR
3.282	4.282	.500	0328 9724	SPLIT	NBR
3.310	4.125	.562	19448 H5MX5489	LDS	FKM
3.310	5.000	.500	14237 H1L5	LPD	NBR
3.312	4.375	.500	TMAL 4375-3234	TMAL	PTFE
3.312	4.499	.625	0312 9829	SPLIT	NBR
3.312	4.500	.468	15288 H1L5	LPD	NBR
3.312	4.500	.468	15288 H5MX5489	LPD	FKM
3.312	4.500	.500	0331 10866	SPLIT	NBR
3.312	4.500	.625	11523 H1L5	LPD	NBR
3.312	4.500	.625	11523 H5L16	LPD	FKM
3.313	3.875	.438	8967 H1L5	R	NBR
3.313	4.063	.375	0313 9215	SPLIT	NBR

See Section 4 for seal type description. For High Misalignment sizes, see Page B-86. For FlexiSeal Listings, see Pages B-93 and B-97.

03/03/06



B

Shaft Dia.	Bore Dia.	Seal Width	Parker Part Number	Seal Type	Material
3.313	4.063	.375	0331 9215	SPLIT	NBR
3.313	4.063	.438	0313 9728	SPLIT	NBR
3.313	4.063	.438	0331 9728	SPLIT	NBR
3.313	4.125	.562	19488 H1L5	LDS	NBR
3.313	4.125	.563	19311 H1L5	LDS	NBR
3.313	4.250	.438	4225 H1L5	RUP	NBR
3.313	4.250	.625	12253 H1L5	LPD	NBR
3.313	4.250	.625	12253 H5L16	LPD	FKM
3.313	4.313	.500	0313 7341	SPLIT	NBR
3.313	4.313	.500	0313 9724	SPLIT	NBR
3.313	4.313	.500	0313 9724 V	SPLIT	FKM
3.313	4.313	.500	0331 9724	SPLIT	NBR
3.313	4.313	.500	0331 9724 V	SPLIT	FKM
3.313	4.374	.500	11083 H1L5	RPD	NBR
3.313	4.374	.500	11083 H5L16	RPD	FKM
3.313	4.375	.438	0313 4266	SPLIT	NBR
3.313	4.375	.438	0331 4266	SPLIT	NBR
3.313	4.375	.500	10963 H1L5	LPD	NBR
3.313	4.375	.500	10963 H1L7	LPD	NBR
3.313	4.375	.500	10963 H5L16	LPD	FKM
3.313	4.375	.625	0313 9725	SPLIT	NBR
3.313	4.500	.500	0313 10232	SPLIT	NBR
3.313	4.500	.500	0313 10866	SPLIT	NBR
3.313	4.500	.500	0331 10232	SPLIT	NBR
3.313	4.625	.625	0313 9001	SPLIT	NBR
3.313	4.625	.625	0331 9001	SPLIT	NBR
3.313	4.750	.500	15676 H1L5	LUP	NBR
3.313	4.750	.500	15676 H5L16	LUP	FKM
3.313	4.999	.375	0502 LDN 843 03313 375 VN	LDN	PTFE
3.313	4.999	.438	3313-4999-438ETAN	TA	NBR
3.313	5.000	.469	9794 H1L5	LUP	NBR
3.313	5.256	.250	15422 H1L7	SS	NBR
3.313	5.500	.563	9591 H1L5	LPD	NBR
3.338	4.338	.500	0333 9724	SPLIT	NBR
3.338	4.338	.500	0338 9724	SPLIT	NBR
3.341	5.118	.500	11785 H1L5	LDS	NBR
3.344	4.090	.438	0334 9728	SPLIT	NBR
3.344	4.344	.500	0334 9724	SPLIT	NBR
3.344	4.469	.375	0334 15332	SPLIT	NBR
3.344	4.532	.500	0334 10866	SPLIT	NBR
3.344	4.594	.250	0334 14939	SPLIT	NBR
3.346	4.134	.512	16431 H1L5	LUP	NBR
3.346	4.134	.512	16431 H5L16	LUP	FKM
3.346	4.331	.472	15321 H1L5	RPD	NBR
3.346	4.331	.500	15544 5066	HP	FKM
3.346	4.724	.472	16094 H1L5	RUP	NBR
3.365	4.380	.688	14427 H1L5	RPD	NBR
3.365	4.380	.688	14427 H5L16	RPD	FKM
3.367	4.813	.500	19290 H1L5	SSW	NBR
3.370	4.188	.341	10320 H1L5	LUP	NBR
3.370	4.188	.341	10320 H5L16	LUP	FKM
3.370	4.548	.313	13132 ALLL5	LPDW	NBR
3.374	4.120	.405	12871 ALLL7	P	NBR
3.375	4.125	.313	9378 H1L5	RPD	NBR
3.375	4.125	.375	15699 5066	HP	FKM
3.375	4.125	.375	15699 5066 304	HP	FKM
3.375	4.125	.375	15699 5066 316	HP	FKM
3.375	4.125	.375	4912 H1L5	RPD	NBR
3.375	4.125	.375	4912 H1L5 PTFE	RPD	N/P
3.375	4.125	.375	4912 H1L7	RPD	NBR
3.375	4.125	.375	4912 H5L16	RPD	FKM
3.375	4.125	.438	0337 9728	SPLIT	NBR
3.375	4.125	.438	0337 9855	SPLIT	NBR
3.375	4.250	.500	16473 H1L20	LDS	XNBR
3.375	4.250	.500	16473 H1L5	LDS	NBR
3.375	4.250	.500	16473 H5L16	LDS	FKM

Shaft Dia.	Bore Dia.	Seal Width	Parker Part Number	Seal Type	Material
3.375	4.250	.625	0337 12401	SPLIT	NBR
3.375	4.250	.625	16541 H1L5	LUP	NBR
3.375	4.340	.305	19633 H1L5	LUP	NBR
3.375	4.375	.250	17954 H1L7	SS	NBR
3.375	4.375	.250	17954 H5L16	SS	FKM
3.375	4.375	.375	20410 H5L16	LUP	FKM
3.375	4.375	.500	16451 5066	HP	FKM
3.375	4.375	.500	16451 5066 304	HP	FKM
3.375	4.375	.500	16451 5066 316	HP	FKM
3.375	4.375	.500	10164 H1L2160	LUP	EPDM
3.375	4.375	.500	10164 H1L5	LUP	NBR
3.375	4.375	.500	10164 H1L5 PTFE	LUP	N/P
3.375	4.375	.500	10164 H1L50	LUP	NBR
3.375	4.375	.500	10164 H5L16	LUP	FKM
3.375	4.375	.500	19227	MP	FKM
3.375	4.375	.500	4289 H1L5	RPD	NBR
3.375	4.375	.500	4289 H5L16	RPD	FKM
3.375	4.375	.500	0337 7341	SPLIT	NBR
3.375	4.375	.500	0337 9724	SPLIT	NBR
3.375	4.375	.500	0337 9724 V	SPLIT	FKM
3.375	4.375	.625	3976 H1L5	RPD	NBR
3.375	4.375	.625	3976 H5L16	RPD	FKM
3.375	4.375	.625	0337 9691	SPLIT	NBR
3.375	4.375	.625	0337 9725	SPLIT	NBR
3.375	4.375	.875	19625 H1L20	LDS	XNBR
3.375	4.376	.375	0502 LDN 501 03375 375 VN	LDN	PTFE
3.375	4.376	.438	3375-4376-438ETBN	TB	NBR
3.375	4.500	.250	17214 414	DS	CR
3.375	4.500	.250	17214 472	DS	FKM
3.375	4.500	.250	17214 H1L2160	DS	EPDM
3.375	4.500	.375	0337 15332	SPLIT	NBR
3.375	4.500	.375	0337 15332 V	SPLIT	FKM
3.375	4.500	.375	0502 LDN 563 03375 375 VN	LDN	PTFE
3.375	4.500	.500	0337 3922	SPLIT	NBR
3.375	4.500	.500	15114 H1L2160	LPDW	EPDM
3.375	4.500	.500	15114 H1L5	LPDW	NBR
3.375	4.500	.500	15114 H5L16	LPDW	FKM
3.375	4.500	.500	9042 H1L5	LPD	NBR
3.375	4.500	.500	9042 H1L5 PTFE	LPD	N/P
3.375	4.500	.500	9042 H5L16	LPD	FKM
3.375	4.500	.562	8841 H1L5	LUP	NBR
3.375	4.500	.562	8841 H1L5 PTFE	LUP	N/P
3.375	4.500	.563	0337 10148	SPLIT	NBR
3.375	4.501	.438	3375-4501-438ETBN	TB	NBR
3.375	4.563	.500	0337 10866	SPLIT	NBR
3.375	4.563	.500	0337 10866 V	SPLIT	FKM
3.375	4.594	.422	8842 H1L5	LPD	NBR
3.375	4.620	.375	11623 ALLL5	RPDT	NBR
3.375	4.625	.250	0337 14939 V	SPLIT	FKM
3.375	4.625	.625	9272 H1L5	RUP	NBR
3.375	4.625	.625	9272 H5L16	RUP	FKM
3.375	4.626	.563	11557 H1L5	LUP	NBR
3.375	4.626	.563	11557 H5L16	LUP	FKM
3.375	4.750	.468	0337 9763	SPLIT	NBR
3.375	4.875	.500	16211 H1L5	LUP	NBR
3.375	4.875	.500	16211 H5L89	LUP	FKM
3.375	5.000	.469	0337 5047	SPLIT	NBR
3.375	5.000	.469	4463 H1L3 PTFE	LUP	CR/PTFE
3.375	5.000	.469	4463 H1L5	LUP	NBR
3.375	5.000	.469	4463 H5L16	LUP	FKM
3.375	5.000	.500	20819 H1L5	LDS	NBR
3.375	5.000	.625	9205 H1L5	LUP	NBR
3.375	5.118	.438	13194 H1L5	LUP	NBR
3.375	5.500	.313	12422 H1L7	SS	NBR
3.376	4.376	.625	TMAL 4376-4032	TMAL	PTFE
3.376	4.626	.562	TMAL 4626-3640	TMAL	PTFE

See Section 4 for seal type description. For High Misalignment sizes, see Page B-86. For FlexiSeal Listings, see Pages B-93 and B-97.

03/03/06



B

Shaft Dia.	Bore Dia.	Seal Width	Parker Part Number	Seal Type	Material
3.376	5.119	.438	15383 H1L5	LPD	NBR
3.380	4.500	.375	0338 15332	SPLIT	NBR
3.380	4.992	.563	9735 H1L5	OLRPD	NBR
3.406	4.813	.463	16155 H1L5	SS	NBR
3.430	4.625	.500	10232 H1L5	RPD	NBR
3.430	4.625	.500	10232 H5MX5489	RPD	FKM
3.432	4.625	.484	19706 H1L7	OLLUP	NBR
3.437	4.500	.500	15471 H1L5	LPD	NBR
3.437	4.500	.500	15471 H1L5 PTFE	LPD	N/P
3.437	4.500	.500	15471 H5L16	LPD	FKM
3.437	4.500	.562	15394 H1L5	LPD	NBR
3.437	4.500	.562	15394 H5L16	LPD	FKM
3.437	5.000	.500	16472 H1L5	LDS	NBR
3.437	5.000	.500	16472 H5L16	LDS	FKM
3.437	5.000	.500	TMAL 5000-3250	TMAL	PTFE
3.438	4.188	.250	5040 414	DS	CR
3.438	4.188	.250	5040 472	DS	FKM
3.438	4.188	.375	17967 5066	HP	FKM
3.438	4.188	.375	17967 5066 304	HP	FKM
3.438	4.188	.375	17967 5066 316	HP	FKM
3.438	4.188	.375	9215 H1L5	RUP	NBR
3.438	4.188	.375	9215 H1L7	RUP	NBR
3.438	4.188	.375	9215 H5L16	RUP	FKM
3.438	4.188	.438	0343 9728	SPLIT	NBR
3.438	4.188	.438	0343 9855	SPLIT	NBR
3.438	4.249	.375	0502 LDN 406 03438 375 VN	LDN	PTFE
3.438	4.249	.375	3438-4249-375ETBN	TB	NBR
3.438	4.313	.625	0343 12401	SPLIT	NBR
3.438	4.438	.500	0343 7341	SPLIT	NBR
3.438	4.438	.500	0343 7341 V	SPLIT	FKM
3.438	4.438	.625	0343 9725	SPLIT	NBR
3.438	4.500	.438	0343 4266	SPLIT	NBR
3.438	4.500	.375	0502 LDN 531 03438 375 VN	LDN	PTFE
3.438	4.500	.438	3438-4500-438ETBN	TB	NBR
3.438	4.625	.500	0343 10866	SPLIT	NBR
3.438	4.625	.500	0343 10866 V	SPLIT	FKM
3.438	4.625	.500	10948 H1L5	LUP	NBR
3.438	4.625	.500	10948 H1L7	LUP	NBR
3.438	4.625	.500	10948 H5L16	LUP	FKM
3.438	4.625	.500	10948 HL15	LUP	NBR
3.438	4.625	.625	10129 H1L5	LPD	NBR
3.438	4.625	.625	9829 H1L5	RPD	NBR
3.438	4.631	.625	6040 H1L5	LUP	NBR
3.438	4.688	.250	0343 14939	SPLIT	NBR
3.438	4.688	.625	0343 3693	SPLIT	NBR
3.438	4.750	.625	0343 9001	SPLIT	NBR
3.438	4.813	.468	0343 9763	SPLIT	NBR
3.438	4.876	.375	0502 LDN 719 03438 375 VN	LDN	PTFE
3.438	4.876	.438	3438-4876-438ETAN	TA	NBR
3.438	4.876	.625	15343 H1L5	LPD	NBR
3.438	4.938	.500	0343 4395	SPLIT	NBR
3.438	5.000	.250	9086 414	DS	CR
3.438	5.000	.468	0343 9559	SPLIT	NBR
3.438	5.000	.469	4275 H1L5	RUP	NBR
3.438	5.000	.500	16169 H1L5	LDS	NBR
3.438	5.000	.500	9512 H1L5	LUP	NBR
3.438	5.000	.500	9512 H5L16	LUP	FKM
3.438	5.250	.875	5311 H1L5	LUP	NBR
3.454	4.380	.375	14611 H1L5	LPD	NBR
3.462	4.250	.472	0346 15396	SPLIT	NBR
3.464	4.331	.472	17279 H1L5	LUP	NBR
3.464	4.331	.472	17279 H5L16	LUP	FKM
3.468	5.000	.500	TMAL 5000-3249	TMAL	PTFE
3.469	4.219	.438	0346 9855	SPLIT	NBR
3.469	4.469	.625	0346 9725	SPLIT	NBR
3.480	4.480	.500	0348 7341	SPLIT	NBR

Shaft Dia.	Bore Dia.	Seal Width	Parker Part Number	Seal Type	Material
3.499	4.343	.500	TMAL 4343-3227	TMAL	PTFE
3.500	4.000	.313	14357 H1L7	P	NBR
3.500	4.000	.313	14357 H5L16	P	FKM
3.500	4.000	.313	7164 H1L5	LPD	NBR
3.500	4.000	.313	7164 H1L5 PTFE	LPD	N/P
3.500	4.000	.313	7164 H5L16	LPD	FKM
3.500	4.125	.250	3500-4125-250EVBN	VB	NBR
3.500	4.250	.250	TMAL 4250-1624	TMAL	PTFE
3.500	4.250	.410	15152 ALL7	P	NBR
3.500	4.250	.438	0350 9855	SPLIT	NBR
3.500	4.250	.438	0350 9855 V	SPLIT	FKM
3.500	4.250	.438	9728 H1L5	RUP	NBR
3.500	4.250	.438	9728 H5L16	RUP	FKM
3.500	4.313	.375	11771 414	DS	CR
3.500	4.344	.500	TMAL 4344-3227	TMAL	PTFE
3.500	4.345	.595	16896 H1L7	P	NBR
3.500	4.345	.595	16896 H5L16	P	FKM
3.500	4.375	.375	0502 LDN 438 03500 375 VN	LDN	PTFE
3.500	4.375	.375	3500-4375-375ETBN	TB	NBR
3.500	4.375	.375	7325 H1L5	LUP	NBR
3.500	4.375	.375	7325 H1L5 PTFE	LUP	N/P
3.500	4.375	.375	7325 H5L16	LUP	FKM
3.500	4.375	.375	7325 MSD 4970	LUP	F/P
3.500	4.375	.438	10773 H1L5	LPD	NBR
3.500	4.375	.438	10773 H5L16	LPD	FKM
3.500	4.375	.625	0350 12401	SPLIT	NBR
3.500	4.500	.438	0350 7074	SPLIT	NBR
3.500	4.500	.438	0350 7074 H1L21	SPLIT	EPDM
3.500	4.500	.438	0350 7074 L21	SPLIT	NBR
3.500	4.500	.438	0350 7074 PTFEV	SPLIT	F/P
3.500	4.500	.438	0350 7074 V	SPLIT	FKM
3.500	4.500	.438	0350 9788	SPLIT	NBR
3.500	4.500	.375	0502 LDN 500 03500 375 VN	LDN	PTFE
3.500	4.500	.438	4221 H1L5	B	NBR
3.500	4.500	.438	9752 H1L5	LUP	NBR
3.500	4.500	.438	9752 H1L7	LUP	NBR
3.500	4.500	.438	9752 H1L70	LUP	NBR
3.500	4.500	.438	9752 H5L16	LUP	FKM
3.500	4.500	.500	0350 6765	SPLIT	NBR
3.500	4.500	.500	0350 6765 V	SPLIT	FKM
3.500	4.500	.500	0350 7341	SPLIT	NBR
3.500	4.500	.500	0350 7341 V	SPLIT	FKM
3.500	4.500	.500	11197 H1L5	LUP	NBR
3.500	4.500	.500	11197 H1L5 PTFE	LUP	N/P
3.500	4.500	.500	11197 H5L16	LUP	FKM
3.500	4.500	.500	12565 H1L5	LDS	NBR
3.500	4.500	.500	12565 H5L16	LDS	FKM
3.500	4.500	.500	16312 5066	HP	FKM
3.500	4.500	.500	16312 5066 304	HP	FKM
3.500	4.500	.500	16312 5066 316	HP	FKM
3.500	4.500	.500	16744 H1L5	LPD	NBR
3.500	4.500	.500	16744 H5L16	LPD	FKM
3.500	4.500	.500	16744 H5MX5489	LPD	FKM
3.500	4.500	.500	17323 H1L5	H	NBR
3.500	4.500	.500	17323 H1L7	H	NBR
3.500	4.500	.500	17323 H5L16	H	FKM
3.500	4.500	.500	9724 H1L21	RUP	EPDM
3.500	4.500	.500	9724 H1L5	RUP	NBR
3.500	4.500	.500	9724 H5L16	RUP	FKM
3.500	4.500	.500	TMAL 4500-3232	TMAL	PTFE
3.500	4.500	.562	9422 H1L5	LPD	NBR
3.500	4.500	.562	9422 H5L16	LPD	FKM
3.500	4.500	.563	0350 12011	SPLIT	NBR
3.500	4.500	.625	0350 9725	SPLIT	NBR
3.500	4.500	.625	10914 H1L5	LPDW	NBR
3.500	4.500	.625	10914 H5L16	LPDW	FKM

See Section 4 for seal type description. For High Misalignment sizes, see Page B-86. For FlexiSeal Listings, see Pages B-93 and B-97.

03/03/06



B

Shaft Dia.	Bore Dia.	Seal Width	Parker Part Number	Seal Type	Material
3.500	4.500	.625	4941 H1L5	LUP	NBR
3.500	4.500	.625	4941 H5L16	LUP	FKM
3.500	4.500	.625	9691 H1L5	RPD	NBR
3.500	4.500	.625	TMAS 4500-4032	TMAS	PTFE
3.500	4.501	.438	3500-4501-438ETBN	TB	NBR
3.500	4.625	.375	15332 H1L5	RPD	NBR
3.500	4.625	.375	15332 H5L16	RPD	FKM
3.500	4.625	.500	0350 3922	SPLIT	NBR
3.500	4.625	.500	10306 H1L5	LUP	NBR
3.500	4.625	.500	10306 H3L8	LUP	CR
3.500	4.625	.500	10306 H5L16	LUP	FKM
3.500	4.625	.500	10306 HL15	LUP	NBR
3.500	4.625	.563	10148 H1L5	RUP	NBR
3.500	4.625	.563	10148 H5L16	RUP	FKM
3.500	4.625	.563	15470 5066	HP	FKM
3.500	4.625	.563	15470 5066 304	HP	FKM
3.500	4.625	.563	15470 5066 316	HP	FKM
3.500	4.631	.563	6327 H1L5	LA	NBR
3.500	4.721	.375	17402 H1L5	LDS	NBR
3.500	4.721	.375	17402 H5L16	LDS	FKM
3.500	4.724	.500	17305 H1L5	SSW	NBR
3.500	4.724	.500	17305 H5L89 PTF	SSW	F/P
3.500	4.724	.500	17305 MX9010L21	SSW	EPDM
3.500	4.730	.500	15633 H1L5	LUP	NBR
3.500	4.750	.250	0350 14939	SPLIT	NBR
3.500	4.750	.375	0502 LDN 625 03500 375 VN	LDN	PTFE
3.500	4.750	.375	3500-4750-375ETBN	TB	NBR
3.500	4.750	.500	0350 6165	SPLIT	NBR
3.500	4.750	.500	0350 6165 V	SPLIT	FKM
3.500	4.750	.500	17544 H1L5	LUPW	NBR
3.500	4.750	.500	17544 H5L16	LUPW	FKM
3.500	4.750	.563	10019 H1L5	LPD	NBR
3.500	4.750	.563	10019 H5L16	LPD	FKM
3.500	4.750	.563	14376 H1L5	LDS	NBR
3.500	4.750	.563	14376 H5L16	LDS	FKM
3.500	4.750	.625	0350 3693	SPLIT	NBR
3.500	4.750	.625	8821 H1L5	LPD	NBR
3.500	4.750	.625	8821 H5L16	LPD	FKM
3.500	4.875	.468	0350 9763	SPLIT	NBR
3.500	4.875	.500	0350 14740	SPLIT	NBR
3.500	4.875	.563	8501 H1L5	LPD	NBR
3.500	4.999	.375	0502 LDN 750 03500 375 VN	LDN	PTFE
3.500	4.999	.438	3500-4999-438ETAN	TA	NBR
3.500	5.000	.468	9410 H1L5	LUP	NBR
3.500	5.000	.468	9410 H5L16	LUP	FKM
3.500	5.000	.500	0350 4395	SPLIT	NBR
3.500	5.000	.500	12689 414	DS	CR
3.500	5.000	.500	16903 H1L5	OLLUP	NBR
3.500	5.000	.562	15810 H1L5	LUP	NBR
3.500	5.000	.562	15810 H5L16	LUP	FKM
3.500	5.000	.562	9457 H1L5	LPDW	NBR
3.500	5.000	.594	17475 H1L5	LDS	NBR
3.500	5.000	.594	17475 H5MX5489	LDS	FKM
3.500	5.000	.594	17593 H1L2160	LDS	EPDM
3.500	5.000	.594	17593 H5L16	LDS	FKM
3.500	5.000	.594	17593 H5MX5489	LDS	FKM
3.500	5.000	.598	17779 H1L5	LDS	NBR
3.500	5.000	.750	0350 7175	SPLIT	NBR
3.500	5.000	.750	0350 7175 V	SPLIT	FKM
3.500	5.006	.469	6301 H1L5	LA	NBR
3.500	5.125	.469	5047 H1L5	RPD	NBR
3.500	5.125	.469	5047 H5L16	RPD	FKM
3.500	5.125	.625	16542 H1L5	LUP	NBR
3.500	5.250	.375	0502 LDN 875 03500 375 VN	LDN	PTFE
3.500	5.250	.500	10110 H1L5	LUP	NBR
3.500	5.250	.500	TMAL 5250-3256	TMAL	PTFE

Shaft Dia.	Bore Dia.	Seal Width	Parker Part Number	Seal Type	Material
3.500	5.251	.438	3500-5251-438ETAN	TA	NBR
3.500	5.375	.250	9083 412	DS	CR
3.500	5.375	.250	9083 414	DS	CR
3.500	5.500	.350	20538 H1L5	SSW	NBR
3.500	5.500	.500	6871 H1L5	LUP	NBR
3.500	5.500	.563	12442 H1L5	LPDW	NBR
3.500	5.500	.625	8999 H1L5	LPD	NBR
3.500	5.511	.500	20657 H1L5	LUP	NBR
3.500	5.625	.625	10915 H1L5	SSW	NBR
3.500	5.625	.625	10915 H5L16	SSW	FKM
3.500	5.906	.625	14054 H1L5	LPDW	NBR
3.500	5.906	.625	14054 H1L5 PTFE	LPDW	N/P
3.500	6.500	.500	19365 H1L5	LUP	NBR
3.530	4.295	.438	19968 5066	HP	FKM
3.530	4.530	.500	0353 7341	SPLIT	NBR
3.532	4.532	.500	0353 6765	SPLIT	NBR
3.532	4.532	.500	0353 6765 V	SPLIT	FKM
3.540	4.524	.472	0354 15320	SPLIT	NBR
3.540	4.790	.500	0354 6165	SPLIT	NBR
3.542	4.542	.500	0354 6765	SPLIT	NBR
3.543	4.331	.433	14302 H1L7	P	NBR
3.543	4.331	.472	15396 H1L5	RPD	NBR
3.543	4.331	.472	15396 H5L16	RPD	FKM
3.543	4.724	.472	13160 H1L5	LPD	NBR
3.543	4.724	.472	13160 H1L5 PTFE	LPD	N/P
3.544	5.500	.625	16656 H1L5	SSW	NBR
3.563	4.438	.438	11059 H1L5	LPD	NBR
3.563	4.438	.438	11059 H5L16	LPD	FKM
3.563	4.438	.625	0356 12401	SPLIT	NBR
3.563	4.500	.469	16543 H1L5	LUP	NBR
3.563	4.500	.469	16543 H1L5 PTFE	LUP	N/P
3.563	4.500	.469	16543 H5L16	LUP	FKM
3.563	4.546	.472	0356 15320	SPLIT	NBR
3.563	4.563	.500	0356 6765	SPLIT	NBR
3.563	4.563	.500	16652 H1L5	LUPW	NBR
3.563	4.625	.438	4266 H1L5	RPD	NBR
3.563	4.625	.438	4266 H5L16	RPD	FKM
3.563	4.625	.438	9892 H1L5	LUP	NBR
3.563	4.625	.438	9892 H5L16	LUP	FKM
3.563	4.625	.469	0356 9864	SPLIT	NBR
3.563	4.750	.500	10866 H1L2160	RUP	EPDM
3.563	4.750	.500	10866 H1L5	RUP	NBR
3.563	4.750	.500	10866 H5L16	RUP	FKM
3.563	4.875	.625	9001 H1L5	R	NBR
3.563	4.938	.500	0356 14740	SPLIT	NBR
3.563	5.004	.500	13958 H1L5	LPD	NBR
3.563	5.004	.500	13958 H5L16	LPD	FKM
3.563	5.063	.500	0356 4395	SPLIT	NBR
3.563	5.125	.469	9559 H1L5	RPD	NBR
3.594	4.344	.500	0359 14906	SPLIT	NBR
3.611	5.375	.500	60029 H1L5	LDS	NBR
3.611	5.375	.500	60029 H1MX9508	LDS	HNBR
3.620	5.222	.215	18445 H1L5	SS	NBR
3.625	4.250	.312	TN 4250-2020	TN	N/P
3.625	4.250	.312	TNV 4250-2020	TN	N/P
3.625	4.375	.375	5140 H1L7	SS	NBR
3.625	4.375	.375	5140 H5L16	SS	FKM
3.625	4.375	.375	TMAL 4375-2424	TMAL	PTFE
3.625	4.375	.438	0362 4417	SPLIT	NBR
3.625	4.375	.438	9855 H1L5	RPD	NBR
3.625	4.375	.438	9855 H5L16	RPD	FKM
3.625	4.375	.500	0362 14906	SPLIT	NBR
3.625	4.500	.625	0362 12401	SPLIT	NBR
3.625	4.625	.438	0502 LDN 500 03625 438 VN	LDN	PTFE
3.625	4.625	.375	3625-4625-375ETBN	TB	NBR
3.625	4.625	.438	0362 7074	SPLIT	NBR

See Section 4 for seal type description. For High Misalignment sizes, see Page B-86. For FlexiSeal Listings, see Pages B-93 and B-97.

03/03/06



Rotary Lip Seal Inch Sizes

3.625 to 3.750

B

Shaft Dia.	Bore Dia.	Seal Width	Parker Part Number	Seal Type	Material
3.625	4.625	.438	0362 7074 V	SPLIT	FKM
3.625	4.625	.438	0362 9788	SPLIT	NBR
3.625	4.625	.438	0362 9788 V	SPLIT	FKM
3.625	4.625	.500	0362 6765	SPLIT	NBR
3.625	4.625	.500	0362 6765 V	SPLIT	FKM
3.625	4.625	.500	11198 H1L5	LUP	NBR
3.625	4.625	.500	11198 H1L5 PTFE	LUP	N/P
3.625	4.625	.500	11198 H5L16	LUP	FKM
3.625	4.625	.500	13136 H1L5	LPDW	NBR
3.625	4.625	.500	19345 5066	HP	FKM
3.625	4.625	.500	19728 H1L7	P	NBR
3.625	4.625	.500	19728 H1L7	P	NBR
3.625	4.625	.500	7341 H1L5	RUP	NBR
3.625	4.625	.500	7341 H5L16	RUP	FKM
3.625	4.625	.500	7341 H5L16 PTFE	RUP	F/P
3.625	4.625	.500	TMAL 4625-3232	TMAL	PTFE
3.625	4.625	.563	12011 H1L5	RPD	NBR
3.625	4.625	.625	9725 H1L5	RPD	NBR
3.625	4.688	.469	0362 9864	SPLIT	NBR
3.625	4.688	.469	0363 9864	SPLIT	NBR
3.625	4.750	.500	0362 3922	SPLIT	NBR
3.625	4.750	.500	0362 3922 V	SPLIT	FKM
3.625	4.750	.625	12159 H1L5	LPD	NBR
3.625	4.750	.625	12677 H1L5	LDS	NBR
3.625	4.750	.625	12677 H5L89	LDS	FKM
3.625	4.751	.438	0502 LDN 563 03625 438 VN	LDN	PTFE
3.625	4.751	.438	3625-4751-438ETBN	TB	NBR
3.625	4.875	.250	14939 H1L5	RUP	NBR
3.625	4.875	.250	14939 H1L5 PTFE	RUP	N/P
3.625	4.875	.250	14939 H5L16	RUP	FKM
3.625	4.875	.500	0362 6165	SPLIT	NBR
3.625	4.875	.500	0362 6165 V	SPLIT	FKM
3.625	4.875	.625	0362 3693	SPLIT	NBR
3.625	4.875	.625	15724 H1L5	LUP	NBR
3.625	4.875	.625	15724 H5L16	LUP	FKM
3.625	4.990	.469	8966 H1L5	R	NBR
3.625	4.999	.375	3625-4999-375ETBN	TB	NBR
3.625	5.000	.438	0502 LDN 688 03625 438 VN	LDN	PTFE
3.625	5.000	.469	9587 H1L5	LPD	NBR
3.625	5.000	.469	9587 H5MX5489	LPD	FKM
3.625	5.000	.469	9763 H1L5	RUP	NBR
3.625	5.000	.500	0362 14740	SPLIT	NBR
3.625	5.125	.500	0362 4395	SPLIT	NBR
3.625	5.125	.750	0362 7166	SPLIT	NBR
3.625	5.125	.750	7175 H1L5	RPD	NBR
3.625	5.125	.750	7175 H5L16	RPD	FKM
3.625	5.251	.438	0502 LDN 813 03625 438 VN	LDN	PTFE
3.625	5.251	.375	3625-5251-375ETAN	TA	NBR
3.625	5.375	.500	12718 H1L5	LPD	NBR
3.625	5.375	.500	12718 H5L16	LPD	FKM
3.625	5.500	.563	8438 H1L5	LPD	NBR
3.625	5.500	.625	16733 H1L5	SSW	NBR
3.630	5.288	.370	19532 5201	MP	FKM
3.644	5.115	.469	16923 H1L5	LUP	NBR
3.654	4.724	.156	12182 H1L7	SS	NBR
3.654	4.724	.375	70006 H1L5	TSS	NBR
3.657	4.657	.438	0365 9788	SPLIT	NBR
3.657	4.657	.500	0365 6765	SPLIT	NBR
3.657	4.907	.500	0365 6165	SPLIT	NBR
3.668	4.849	.512	14064 H1L5	RPD	NBR
3.676	4.625	.375	9515 414	DS	CR
3.676	4.625	.375	9515 ALL414	DS	CR
3.687	4.812	.500	0367 3922	SPLIT	NBR
3.688	4.500	.438	0502 LDN 406 03688 438 VN	LDN	PTFE
3.688	4.501	.438	3688-4501-438ETBN	TB	NBR
3.688	4.563	.438	4086 H1L5	LUP	NBR

Shaft Dia.	Bore Dia.	Seal Width	Parker Part Number	Seal Type	Material
3.688	4.563	.438	4086 H1L5 PTFE	LUP	N/P
3.688	4.563	.438	4086 H5L16	LUP	FKM
3.688	4.688	.438	0368 9788	SPLIT	NBR
3.688	4.688	.500	0368 6765	SPLIT	NBR
3.688	4.688	.500	0368 6765 V	SPLIT	FKM
3.688	4.750	.375	0368 5912	SPLIT	NBR
3.688	4.750	.469	0368 9864	SPLIT	NBR
3.688	4.750	.469	0368 9864 V	SPLIT	FKM
3.688	4.750	.469	0368 9879	SPLIT	NBR
3.688	4.750	.500	15929 H1L5	LUP	NBR
3.688	4.750	.500	15929 H1L5 PTFE	LUP	N/P
3.688	4.750	.625	6808 H1L5	LA	NBR
3.688	4.813	.500	0368 3922	SPLIT	NBR
3.688	4.813	.500	0368 9322	SPLIT	NBR
3.688	4.875	.469	0368 10484	SPLIT	NBR
3.688	4.875	.625	11664 H1L5	LPD	NBR
3.688	4.875	.625	11664 H1L5 PTFE	LPD	N/P
3.688	4.938	.375	7161 H1L5	LPD	NBR
3.688	4.938	.500	0368 6165	SPLIT	NBR
3.688	5.000	.500	8502 H1L5	LUP	NBR
3.688	5.063	.500	0368 14740	SPLIT	NBR
3.688	5.250	.469	18532 H1L5	LUP	NBR
3.688	5.250	.469	18532 H5L16	LUP	FKM
3.688	5.625	.469	13196 H1L5	LPD	NBR
3.690	4.940	.500	0369 6165	SPLIT	NBR
3.719	4.665	.375	0371 5711	SPLIT	NBR
3.719	4.719	.438	0371 9788	SPLIT	NBR
3.719	4.719	.500	0371 6765	SPLIT	NBR
3.719	4.750	.438	9729 H1L5	LUP	NBR
3.719	4.781	.469	0371 9864	SPLIT	NBR
3.719	4.787	.469	0371 11786	SPLIT	NBR
3.719	4.907	.469	0371 10484	SPLIT	NBR
3.719	4.969	.500	0371 6165	SPLIT	NBR
3.725	4.850	.500	0372 3922	SPLIT	NBR
3.726	4.726	.500	0372 6765	SPLIT	NBR
3.732	4.795	.469	0373 9879	SPLIT	NBR
3.740	4.213	.354	16291 H1L7	H	NBR
3.740	4.331	.394	19493 H1L5	LUP	NBR
3.740	4.331	.394	19493 H5L89	LUP	FKM
3.740	4.449	.394	18761 5066	HP	FKM
3.740	4.527	.394	19492 H1L5	LUP	NBR
3.740	4.528	.472	15120 H1L5	LPD	NBR
3.740	4.528	.472	15120 H5L16	LPD	FKM
3.740	4.528	.472	15120 H5L16 PTF	LPD	F/P
3.740	4.724	.472	15320 H1L5	RPD	NBR
3.740	4.724	.472	15320 H5MX5489	RPD	FKM
3.740	5.709	.551	18377 H1L5	LUP	NBR
3.740	5.709	.551	18377 H5L89	LUP	FKM
3.740	5.807	.551	20418 ALLL5	SDS	NBR
3.748	4.500	.250	13009 H1L20	SSW	XNBR
3.748	4.500	.250	13009 H1L5	SSW	NBR
3.750	4.250	.438	4169 H1L5	LUP	NBR
3.750	4.375	.500	0375 9724 V	SPLIT	FKM
3.750	4.500	.250	12049 414	DS	CR
3.750	4.500	.250	12049 H5	DS	NBR
3.750	4.500	.313	11182 H1L7	OLSS	NBR
3.750	4.500	.410	13453 ALLL7	P	NBR
3.750	4.500	.438	0375 4417	SPLIT	NBR
3.750	4.500	.438	0375 4417 V	SPLIT	FKM
3.750	4.500	.500	0375 14906	SPLIT	NBR
3.750	4.562	.313	0375 9699	SPLIT	NBR
3.750	4.625	.500	0375 16819	SPLIT	NBR
3.750	4.625	.625	12401 H1L5	RPD	NBR
3.750	4.625	.625	12401 H5L16	RPD	FKM
3.750	4.750	.438	0502 LDN 500 03750 438 VN	LDN	PTFE
3.750	4.750	.375	16761 H1L5	LDS	NBR

See Section 4 for seal type description. For High Misalignment sizes, see Page B-86. For FlexiSeal Listings, see Pages B-93 and B-97.

03/03/06



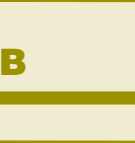

Shaft Dia.	Bore Dia.	Seal Width	Parker Part Number	Seal Type	Material
3.750	4.750	.375	16761 H5L16	LDS	FKM
3.750	4.750	.375	60024 H1L5	LDS	NBR
3.750	4.750	.438	0375 9788	SPLIT	NBR
3.750	4.750	.438	0375 9788 V	SPLIT	FKM
3.750	4.750	.500	0375 10175	SPLIT	NBR
3.750	4.750	.500	0375 6765	SPLIT	NBR
3.750	4.750	.500	0375 6765 V	SPLIT	FKM
3.750	4.750	.500	10846 9010/9614	SS	SPEC
3.750	4.750	.500	10846 H1L7	SS	NBR
3.750	4.750	.500	10846 H5L16	SS	FKM
3.750	4.750	.500	11102 H1L5	LUPW	NBR
3.750	4.750	.500	17199 H1L5	LDS	NBR
3.750	4.750	.500	18803 H1L5	LUP	NBR
3.750	4.750	.500	18803 H5L16	LUP	FKM
3.750	4.750	.500	3705 H1L5	B	NBR
3.750	4.750	.500	7146 H1L5	LUP	NBR
3.750	4.750	.500	7146 H1L5 PTFE	LUP	N/P
3.750	4.750	.500	7146 H1L70	LUP	NBR
3.750	4.750	.500	7146 H1MX9508	LUP	HNBR
3.750	4.750	.500	7146 H5L16	LUP	FKM
3.750	4.750	.500	7146 H5L16 PTFE	LUP	F/P
3.750	4.750	.563	12115 H1L5	LPD	NBR
3.750	4.750	.563	12115 H1L5 PTFE	LPD	N/P
3.750	4.750	.625	14443 H1L5	LDS	NBR
3.750	4.750	.625	14443 H5L16	LDS	FKM
3.750	4.750	.625	14443 H5MX5489	LDS	FKM
3.750	4.750	.625	6872 H1L5	LPD	NBR
3.750	4.750	.625	6872 H5L16	LUP	FKM
3.750	4.751	.375	3750-4751-375ETBN	TB	NBR
3.750	4.813	.469	0375 9864	SPLIT	NBR
3.750	4.875	.438	0502 LDN 563 03750 438 VN	LDN	PTFE
3.750	4.875	.375	3750-4875-375ETBN	TB	NBR
3.750	4.875	.406	11040 H1L5	LPD	NBR
3.750	4.875	.406	11040 H1L7	LPD	NBR
3.750	4.875	.406	11040 H5L16	LPD	FKM
3.750	4.875	.406	11040 H5L16 PTF	LPD	F/P
3.750	4.875	.500	0375 3922	SPLIT	NBR
3.750	4.875	.500	19074 H1L5	RPD	NBR
3.750	4.938	.469	0375 10484	SPLIT	NBR
3.750	4.999	.375	3750-4999-375ETAN	TA	NBR
3.750	5.000	.438	0502 LDN 625 03750 438 VN	LDN	PTFE
3.750	5.000	.375	12667 H1L5	SSW	NBR
3.750	5.000	.468	20435 H5MX5489	LUP	FKM
3.750	5.000	.469	10057 H1L5	LUP	NBR
3.750	5.000	.469	18024 H1L5	LPD	NBR
3.750	5.000	.469	18024 H5L16	LPD	FKM
3.750	5.000	.500	0375 6165	SPLIT	NBR
3.750	5.000	.500	0375 6165 V	SPLIT	FKM
3.750	5.000	.500	10859 H1L5	LPD	NBR
3.750	5.000	.500	10859 H5L16	LPD	FKM
3.750	5.000	.500	TMAL 5000-3240	TMAL	PTFE
3.750	5.000	.625	16624 5066	HP	FKM
3.750	5.000	.625	16624 5066 304	HP	FKM
3.750	5.000	.625	16624 5066 316	HP	FKM
3.750	5.000	.625	3693 H1L5	RUP	NBR
3.750	5.000	.625	3693 H1L5 PTFE	RUP	N/P
3.750	5.006	.469	12797 H1L5	LDS	NBR
3.750	5.006	.469	12797 H5L16	LDS	FKM
3.750	5.006	.469	6294 H1L5	LA	NBR
3.750	5.125	.500	0375 14740	SPLIT	NBR
3.750	5.125	.500	0375 14740 V	SPLIT	FKM
3.750	5.125	.625	10156 H1L5	LPDW	NBR
3.750	5.126	.625	10156 H1L3	LPDW	NBR
3.750	5.126	.625	10156 H1L5	LPDW	NBR
3.750	5.250	.469	13770 H1L5	LUP	NBR
3.750	5.250	.469	13770 H5L16	LUP	FKM

Shaft Dia.	Bore Dia.	Seal Width	Parker Part Number	Seal Type	Material
3.750	5.250	.500	0375 5823	SPLIT	NBR
3.750	5.250	.500	4395 H1L5	RPD	NBR
3.750	5.250	.523	18268 H1L5	RUP	NBR
3.750	5.250	.750	0375 7166	SPLIT	NBR
3.750	5.313	.375	16887 H1L5	SSW	NBR
3.750	5.313	.375	16887 H5L16	SSW	FKM
3.750	5.875	.250	6821 H1L5	LUP	NBR
3.750	6.000	.750	2416 405	P	CR
3.766	5.000	.406	16651 H1L5	SSW	NBR
3.782	4.782	.438	0378 9788	SPLIT	NBR
3.782	4.782	.500	0378 10175	SPLIT	NBR
3.782	5.282	.500	0378 5823	SPLIT	NBR
3.812	4.750	.375	20849 5066	HP	FKM
3.812	5.000	.188	20511 MX5489	MP	FKM
3.813	4.500	.344	18896	MP	FKM
3.813	4.563	.438	0381 4417	SPLIT	NBR
3.813	4.625	.313	0381 9699	SPLIT	NBR
3.813	4.750	.375	9762 H1L5	LUP	NBR
3.813	4.750	.375	9762 H5L16	LUP	FKM
3.813	4.750	.375	9762 H5L89	LUP	FKM
3.813	4.813	.438	0381 9788	SPLIT	NBR
3.813	4.813	.500	0381 10175	SPLIT	NBR
3.813	4.875	.469	0381 9864	SPLIT	NBR
3.813	4.875	.469	0381 9864 V	SPLIT	FKM
3.813	4.875	.625	12156 H1L5	LUP	NBR
3.813	4.875	.625	12156 H5L16	LUP	FKM
3.813	5.000	.469	0381 10484	SPLIT	NBR
3.813	5.000	.469	7014 H1L5	LA	NBR
3.813	5.250	.469	16544 H1L5	LUP	NBR
3.813	5.313	.500	0381 5823	SPLIT	NBR
3.813	5.500	.500	8969 H1L5	LUP	NBR
3.844	4.594	.375	17971 5066	HP	FKM
3.844	4.594	.375	17971 5066 304	HP	FKM
3.844	4.594	.375	17971 5066 316	HP	FKM
3.844	4.844	.438	0384 9788	SPLIT	NBR
3.844	4.844	.500	0384 10175	SPLIT	NBR
3.844	4.906	.469	0384 9879	SPLIT	NBR
3.865	4.865	.500	0386 10175	SPLIT	NBR
3.870	4.625	.500	13123 H1L5	P	NBR
3.870	4.625	.500	13123 H1L7	P	NBR
3.870	4.625	.500	17159 ALLL5	SPC	NBR
3.875	4.625	.375	17209 5066	HP	FKM
3.875	4.625	.375	17209 5066 304	HP	FKM
3.875	4.625	.375	17209 5066 316	HP	FKM
3.875	4.625	.375	17209 5066 SPEC	HP	FKM
3.875	4.625	.438	0387 4417	SPLIT	NBR
3.875	4.625	.500	14906 H1L5	RPD	NBR
3.875	4.625	.563	0387 10042	SPLIT	NBR
3.875	4.750	.437	15641 H1L5	LPD	NBR
3.875	4.750	.437	15641 H5L16	LPD	FKM
3.875	4.750	.437	15641 H5MX5489	LPD	FKM
3.875	4.750	.438	0502 LDN 438 03875 438 VN	LDN	PTFE
3.875	4.750	.438	15389 H1L5	LPDW	NBR
3.875	4.750	.438	4267 H1L5	B	NBR
3.875	4.750	.500	0387 17022	SPLIT	NBR
3.875	4.750	.500	12654 H1L5	LPD	NBR
3.875	4.750	.500	12654 H5L16	LPD	FKM
3.875	4.750	.500	16269 H1L5	LDS	NBR
3.875	4.750	.625	4487 H1L5	B	NBR
3.875	4.751	.438	3875-4751-438ETBN	TB	NBR
3.875	4.875	.375	18177 H1L5	SSW	NBR
3.875	4.875	.438	0387 10468	SPLIT	NBR
3.875	4.875	.438	7074 H1L2160	RUP	EPDM
3.875	4.875	.438	7074 H1L5	RUP	NBR
3.875	4.875	.438	7074 H5L16	RUP	FKM
3.875	4.875	.438	7074 H5L16 PTFE	RUP	F/P

See Section 4 for seal type description. For High Misalignment sizes, see Page B-86. For FlexiSeal Listings, see Pages B-93 and B-97.

03/03/06



Rotary Lip Seal Inch Sizes

3.875 to 3.938

B

Shaft Dia.	Bore Dia.	Seal Width	Parker Part Number	Seal Type	Material
3.875	4.875	.437	9764 H1L5	LUP	NBR
3.875	4.875	.437	9764 H1L5 PTFE	LUP	N/P
3.875	4.875	.437	9764 H1L7	LUP	NBR
3.875	4.875	.437	9764 H5MX5489	LUP	FKM
3.875	4.875	.438	0387 9788	SPLIT	NBR
3.875	4.875	.438	0387 9788 V	SPLIT	FKM
3.875	4.875	.438	0502 LDN 500 03875 438 VN	LDN	PTFE
3.875	4.875	.438	3875-4875-438ETAN	TA	NBR
3.875	4.875	.500	0387 10175	SPLIT	NBR
3.875	4.875	.500	0387 10175 V	SPLIT	FKM
3.875	4.875	.500	6765 H1L5	RUP	NBR
3.875	4.875	.500	6765 H5L16	RUP	FKM
3.875	4.875	.625	10926 H1L5	LPDW	NBR
3.875	4.875	.625	10926 H5L16	LPDW	FKM
3.875	4.937	.469	0387 9879	SPLIT	NBR
3.875	4.938	.375	0387 5912	SPLIT	NBR
3.875	4.942	.469	0387 11786	SPLIT	NBR
3.875	4.999	.438	0502 LDN 562 03875 438 VN	LDN	PTFE
3.875	4.999	.375	3875-4999-375ETAN	TA	NBR
3.875	5.000	.469	6218 H1L5	LUP	NBR
3.875	5.000	.469	6218 H1L70	LUP	NBR
3.875	5.000	.469	6218 H5L16	LUP	FKM
3.875	5.000	.500	3922 H1L5	RUP	NBR
3.875	5.000	.500	3922 H5L16	RUP	FKM
3.875	5.000	.563	19334 H1L5	RUP	NBR
3.875	5.063	.469	0387 10484	SPLIT	NBR
3.875	5.120	.375	13391 ALLL5	RPDT	NBR
3.875	5.125	.438	19354 H1L5	SSW	NBR
3.875	5.125	.500	12409 H1L5	LPD	NBR
3.875	5.125	.500	12409 H5L16	LPD	FKM
3.875	5.125	.500	6165 H1L5	RPD	NBR
3.875	5.125	.500	6165 H5L16	RPD	FKM
3.875	5.250	.438	0502 LDN 688 03875 438 VN	LDN	PTFE
3.875	5.250	.500	14740 H1L5	RPD	NBR
3.875	5.250	.500	14740 H5L16	RPD	FKM
3.875	5.250	.531	16050 H1L5	SSW	NBR
3.875	5.250	.687	TMAL 5250-4444	TMAL	PTFE
3.875	5.251	.438	3875-5251-438ETAN	TA	NBR
3.875	5.375	.438	0502 LDN 750 03875 438 VN	LDN	PTFE
3.875	5.375	.438	3875-5375-438ETAN	TA	NBR
3.875	5.375	.500	0387 5823	SPLIT	NBR
3.875	5.375	.500	16545 H1L5	LUP	NBR
3.875	5.500	.438	0502 LDN 813 03875 438 VN	LDN	PTFE
3.875	5.500	.563	16546 H1L5	LUP	NBR
3.875	5.500	.563	16546 H5L16	LUP	FKM
3.875	5.688	.750	11177 H1L5	LPD	NBR
3.906	4.907	.500	0390 10175	SPLIT	NBR
3.906	4.969	.375	0390 5912	SPLIT	NBR
3.906	4.969	.469	0390 9879	SPLIT	NBR
3.906	5.094	.469	0390 10484	SPLIT	NBR
3.906	5.400	.750	0390 9472	SPLIT	NBR
3.930	5.000	.375	5910 H1L5	LPD	NBR
3.930	5.000	.375	5910 H1L5 PTFE	LPD	N/P
3.930	5.000	.375	5910 H5L16	LPD	FKM
3.930	5.000	.375	5910 H5MX5489	LPD	FKM
3.932	5.906	.500	11791 H1L5	LDS	NBR
3.936	4.750	.313	10990 H1L5	LUP	NBR
3.936	4.750	.313	10990 H5L16	LUP	FKM
3.936	4.750	.375	4023 H1L5	LPD	NBR
3.936	4.750	.375	4023 H1L5 PTFE	LPD	N/P
3.936	4.750	.375	4023 H5L16	LPD	FKM
3.937	5.000	.500	TMAL 5000-3234	TMAL	PTFE
3.937	5.906	.500	14368 ALLL5	MCL	NBR
3.938	4.250	.438	0393 4266	SPLIT	NBR
3.938	4.409	.354	15518 H1L7	P	NBR
3.938	4.688	.375	TMAL 4688-2424	TMAL	PTFE

Shaft Dia.	Bore Dia.	Seal Width	Parker Part Number	Seal Type	Material
3.938	4.688	.563	0393 10042	SPLIT	NBR
3.938	4.750	.313	0393 9699	SPLIT	FKM
3.938	4.750	.313	0393 9699	SPLIT	NBR
3.938	4.750	.313	0393 9699 V	SPLIT	FKM
3.938	4.875	.469	17308 H1L5	LUP	NBR
3.938	4.875	.469	17308 H5L16	LUP	FKM
3.938	4.882	.375	0393 5711	SPLIT	NBR
3.938	4.922	.551	14256 H1L7	P	NBR
3.938	4.938	.438	0393 10468 V	SPLIT	FKM
3.938	4.938	.438	0393 10468	SPLIT	NBR
3.938	4.938	.438	0393 10468	SPLIT	NBR
3.938	4.938	.438	0393 9788	SPLIT	NBR
3.938	4.938	.500	0393 10175	SPLIT	NBR
3.938	4.938	.500	0393 10175 V	SPLIT	FKM
3.938	4.938	.500	17224 H1L5	LUP	NBR
3.938	4.938	.500	17224 H1L5 PTFE	LUP	N/P
3.938	4.938	.500	17224 H5L16	LUP	FKM
3.938	4.938	.500	TMAS 4938-3232	TMAS	PTFE
3.938	4.965	.305	17085 H1L5	LUPW	NBR
3.938	5.000	.250	9084 414	DS	CR
3.938	5.000	.375	0393 5912	SPLIT	NBR
3.938	5.000	.375	0393 5912 PTFE	SPLIT	N/P
3.938	5.000	.375	5910 H1L5	LPD	NBR
3.938	5.000	.375	5910 H1L5 PTFE	LPD	N/P
3.938	5.000	.375	5910 H5L16	LPD	FKM
3.938	5.000	.375	5910 H5MX5489	LPD	FKM
3.938	5.000	.438	0502 LDN 531 03938 438 VN	LDN	PTFE
3.938	5.000	.438	3938-5000-438ETBN	TB	NBR
3.938	5.000	.468	9402 H1L5	LUP	NBR
3.938	5.000	.468	9402 H5MX5489	LUP	FKM
3.938	5.000	.468	9402 H5L16	LUP	FKM
3.938	5.000	.468	9402 H5L16 S	LUP	FKM
3.938	5.000	.468	9402 H5MX5489	LUP	FKM
3.938	5.000	.469	0393 9879	SPLIT	NBR
3.938	5.000	.469	0393 9879 V	SPLIT	FKM
3.938	5.000	.469	9864 H1L5	RUP	NBR
3.938	5.000	.469	9864 H1L5 PTFE	RUP	N/P
3.938	5.000	.469	9864 H5L16	RUP	FKM
3.938	5.000	.500	11239 H1L5	LPDW	NBR
3.938	5.000	.500	11239 H1L5 PTFE	LPDW	N/P
3.938	5.000	.500	11239 H5L16	LPDW	FKM
3.938	5.000	.500	16170 H1L5	LDSW	NBR
3.938	5.000	.500	19230 H1L5	LUP	NBR
3.938	5.000	.500	19230 H5L16	LUP	FKM
3.938	5.000	.500	9510 H1L5	LUP	NBR
3.938	5.000	.500	9510 H5L16	LUP	FKM
3.938	5.000	.625	0393 12376	SPLIT	NBR
3.938	5.004	.469	0393 11786	SPLIT	NBR
3.938	5.125	.469	0393 10484	SPLIT	NBR
3.938	5.125	.469	5192 H1L5	LPD	NBR
3.938	5.125	.469	5192 H1L5 PTFE	LPD	N/P
3.938	5.125	.469	5192 H5L16	LPD	FKM
3.938	5.133	.625	10219 H1L5	LPD	NBR
3.938	5.187	.500	0393 9556	SPLIT	NBR
3.938	5.250	.468	6072 H1L5	LUP	NBR
3.938	5.250	.468	6072 H1L5 PTFE	LUP	N/P
3.938	5.250	.468	6072 H5L16	LUP	FKM
3.938	5.250	.468	6072 H5L16 PTFE	LUP	F/P
3.938	5.250	.468	6072 HL15	LUP	NBR
3.938	5.250	.562	11669 H1L5	LPD	NBR
3.938	5.375	.500	8503 H1L5	LPD	NBR
3.938	5.375	.500	8503 H1L5 PTFE	LPD	N/P
3.938	5.375	.688	12357 H1L5	LDS	NBR
3.938	5.375	.688	13748 H1L5	LDS	NBR
3.938	5.438	.500	0393 5823	SPLIT	NBR
3.938	5.438	.750	0393 9472	SPLIT	NBR

See Section 4 for seal type description. For High Misalignment sizes, see Page B-86. For FlexiSeal Listings, see Pages B-93 and B-97.

03/03/06





Shaft Dia.	Bore Dia.	Seal Width	Parker Part Number	Seal Type	Material
3.938	5.500	.500	0393 11779	SPLIT	NBR
3.938	5.500	.563	8504 H1L5	LUP	NBR
3.938	5.500	.563	8504 H5L16	LUP	FKM
3.938	5.750	.625	14613 H1L3	SSW	CR
3.938	5.750	.625	14613 H1L5	SSW	NBR
3.938	5.750	.625	14613 H1L5 PTFE	SSW	N/P
3.938	5.906	.500	60009 H1L5	LDS	NBR
3.940	5.000	.625	0394 12376	SPLIT	NBR
3.941	5.004	.469	0394 9879	SPLIT	NBR
3.941	5.004	.469	0394 9879 L21	SPLIT	EPDM
3.969	4.718	.563	0396 10042	SPLIT	NBR
3.969	4.969	.438	0396 10468	SPLIT	NBR
3.973	4.724	.472	30071 H5L16	LUP	FKM
3.975	4.875	.299	10950 H1L5	LPD	NBR
3.975	4.875	.299	10950 H5L16	LPD	FKM
3.984	4.984	.500	0398 10175	SPLIT	NBR
3.984	5.380	.500	15575 H1L5	LUP	NBR
3.994	4.994	.500	0399 10175	SPLIT	NBR
3.995	4.995	.438	0399 10468	SPLIT	NBR
4.000	4.500	.250	4000-4500-250EVBN	VB	NBR
4.000	4.500	.375	11993 H1L7	P	NBR
4.000	4.500	.375	11993 H5MX5489	P	FKM
4.000	4.625	.438	12943 H1L5	P	NBR
4.000	4.625	.438	12943 H1L7	P	NBR
4.000	4.750	.410	11917 ALLL7	P	NBR
4.000	4.750	.410	11917 H1L7	P	NBR
4.000	4.750	.410	11917 H5L16	P	FKM
4.000	4.750	.438	4417 H1L5	RUP	NBR
4.000	4.750	.438	4417 H5L16	RUP	FKM
4.000	4.750	.438	9143 H1L5	LUP	NBR
4.000	4.750	.438	9143 H1L5 PTFE	LUP	N/P
4.000	4.750	.438	9143 H5L16	LUP	FKM
4.000	4.750	.563	0400 10042	SPLIT	NBR
4.000	4.813	.313	9699 H1L5	RUP	NBR
4.000	4.813	.313	9699 H5L16	RUP	FKM
4.000	4.875	.250	10723 414	DS	CR
4.000	4.875	.438	17309 H1L5	LUP	NBR
4.000	4.875	.438	17309 H5L89	LUP	FKM
4.000	4.875	.500	0400 17022	SPLIT	NBR
4.000	4.875	.500	16819 H1L5	RUP	NBR
4.000	4.875	.563	13292 H1L5	LPD	NBR
4.000	4.875	.625	14959 H1L5	LPD	NBR
4.000	4.875	.625	14959 H5L16	LPD	FKM
4.000	4.876	.438	0502 LDN 438 04000 438 VN	LDN	PTFE
4.000	4.876	.375	4000-4876-375ETAN	TA	NBR
4.000	4.999	.375	4000-4999-375ETAN	TA	NBR
4.000	5.000	.438	0502 LDN 500 04000 438 VN	LDN	PTFE
4.000	5.000	.375	TMAL 5000-2432	TMAL	PTFE
4.000	5.000	.400	19583 H1L5	LUP	NBR
4.000	5.000	.400	19583 H5/MX5489	LUP	FKM
4.000	5.000	.437	9866 H1L5	LUP	NBR
4.000	5.000	.437	9866 H1L5 PTFE	LUP	N/P
4.000	5.000	.437	9866 H5/MX5489	LUP	FKM
4.000	5.000	.437	9866 H5L16	LUP	FKM
4.000	5.000	.437	9866 H5L16 PTFE	LUP	F/P
4.000	5.000	.438	0400 10468	SPLIT	NBR
4.000	5.000	.438	0400 10468 V	SPLIT	FKM
4.000	5.000	.438	12628 H1L5	LPDW	NBR
4.000	5.000	.438	9788 H1L5	RPD	NBR
4.000	5.000	.438	9788 H5L16	RPD	FKM
4.000	5.000	.468	6146 H1L20	LUP	XNBR
4.000	5.000	.468	6146 H1L5	LUP	NBR
4.000	5.000	.468	6146 H5L16	LUP	FKM
4.000	5.000	.500	0400 10175	SPLIT	NBR
4.000	5.000	.500	0400 10175 V	SPLIT	FKM
4.000	5.000	.500	15141 H1L5	LDS	NBR

Shaft Dia.	Bore Dia.	Seal Width	Parker Part Number	Seal Type	Material
4.000	5.000	.500	15141 H5L16	LDS	FKM
4.000	5.000	.500	19204 H1L5	LUPW	NBR
4.000	5.000	.500	7199 H1L2160	LUP	EPDM
4.000	5.000	.500	7199 H1L5	LUP	NBR
4.000	5.000	.500	7199 H1L5 PTFE	LUP	N/P
4.000	5.000	.500	7199 H1L7	LUP	NBR
4.000	5.000	.500	7199 H1L7 PTFE	LUP	N/P
4.000	5.000	.500	7199 H1L70	LUP	NBR
4.000	5.000	.500	7199 H5L16	LUP	FKM
4.000	5.000	.500	7199 H5L16 PTFE	LUP	N/P
4.000	5.000	.500	9342 H1L7	SS	NBR
4.000	5.000	.500	9342 H1L7 PTFE	SS	N/P
4.000	5.000	.500	TMAS 5000-3232	TMAS	PTFE
4.000	5.000	.516	11336 H1L7	H	NBR
4.000	5.000	.516	11336 H5L16	H	FKM
4.000	5.000	.563	0400 9473	SPLIT	NBR
4.000	5.000	.625	11500 H1L5	LPD	NBR
4.000	5.000	.625	11500 H5L16	LPD	FKM
4.000	5.025	.500	0400 9210	SPLIT	NBR
4.000	5.063	.625	0400 12376	SPLIT	NBR
4.000	5.125	.438	0502 LDN 563 04000 438 VN	LDN	PTFE
4.000	5.125	.438	4000-5125-438ETAN	TA	NBR
4.000	5.125	.500	0400 4406	SPLIT	NBR
4.000	5.125	.500	11635 H1L5	LPD	NBR
4.000	5.125	.500	11635 H5MX5489	LPD	FKM
4.000	5.125	.625	11119 H1L5	LPD	NBR
4.000	5.250	.438	0502 LDN 625 04000 438 VN	LDN	PTFE
4.000	5.250	.438	4000-5250-438ETAN	TA	NBR
4.000	5.250	.468	5489 H1L5	LPD	NBR
4.000	5.250	.468	5489 H5L16	LPD	FKM
4.000	5.250	.500	0400 9556	SPLIT	NBR
4.000	5.250	.500	0400 9556 V	SPLIT	FKM
4.000	5.250	.562	15811 H1L5	LUP	NBR
4.000	5.250	.562	15811 H5L16	LUP	FKM
4.000	5.250	.562	15811 H5MX5489	LUP	FKM
4.000	5.250	.562	15811 MX9010L21	LUP	EPDM
4.000	5.250	.563	20847 H1L5	LDS	NBR
4.000	5.250	.625	15092 5066	HP	FKM
4.000	5.250	.625	15092 5066 304	HP	FKM
4.000	5.250	.625	15092 5066 316	HP	FKM
4.000	5.250	.750	11662 H1L5	OLLUP	NBR
4.000	5.250	.750	11662 H5L16	OLLUP	FKM
4.000	5.250	.750	11662 H5MX5489	OLLUP	FKM
4.000	5.367	.500	9586 H1L5	LPD	NBR
4.000	5.375	.500	16751 H1L5	LUP	NBR
4.000	5.375	.613	80106 H1L5	MIST	NBR
4.000	5.376	.438	0502 LDN 688 04000 438 VN	LDN	PTFE
4.000	5.376	.438	4000-5376-438ETAN	TA	NBR
4.000	5.500	.260	16156 H1L5	SDS	NBR
4.000	5.500	.438	0502 LDN 750 04000 438 VN	LDN	PTFE
4.000	5.500	.500	4300 H1L5	B	NBR
4.000	5.500	.500	10285 H1L5	LPD	NBR
4.000	5.500	.500	0400 5823	SPLIT	NBR
4.000	5.500	.563	9458 H1L5	LPDW	NBR
4.000	5.500	.563	9458 H1L5MD3476	LPDW	NBR
4.000	5.500	.563	9458 H1L5MD5913	LPDW	NBR
4.000	5.500	.563	9458 H5L16	LPDW	FKM
4.000	5.500	.563	7130 H1L5	LUP	NBR
4.000	5.500	.625	10384 H1L5	LPD	NBR
4.000	5.500	.625	7195 H1L5	LUP	NBR
4.000	5.500	.625	7195 H5L16	LUP	FKM
4.000	5.500	.750	0400 19232	SPLIT	NBR
4.000	5.500	.750	0400 9472	SPLIT	NBR
4.000	5.500	.750	7166 H1L5	RPD	NBR
4.000	5.501	.438	4000-5501-438ETAN	TA	NBR
4.000	5.511	.563	13008 H1L5	LPD	NBR

See Section 4 for seal type description. For High Misalignment sizes, see Page B-86.
For FlexiSeal Listings, see Pages B-93 and B-97.

03/03/06



Rotary Lip Seal Inch Sizes

4.000 to 4.188

B

Shaft Dia.	Bore Dia.	Seal Width	Parker Part Number	Seal Type	Material
4.000	5.563	.500	0400 11779	SPLIT	NBR
4.000	5.625	.500	60003 H1L5	LDS	NBR
4.000	5.625	.500	9994 H1L20	LPD	XNBR
4.000	5.625	.500	9994 H5MX5489	LPD	FKM
4.000	5.625	.500	10454 H1L5	LUP	NBR
4.000	5.625	.500	10454 H5L16	LUP	FKM
4.000	5.626	.438	4000-5626-438ETAN	TA	NBR
4.000	5.750	.500	4784 H1L5	LPD	NBR
4.000	5.750	.563	9151 H1L5	LPD	NBR
4.000	5.750	.563	9151 H5L16	LPD	FKM
4.000	5.750	.625	15943 H1L5	SSW	NBR
4.000	5.750	.656	13127 H1L5	LUPW	NBR
4.000	5.751	.438	4000-5751-438ETAN	TA	NBR
4.000	5.875	.500	8807 H1L5	LUP	NBR
4.000	6.000	.500	9663 H1L5	LPD	NBR
4.000	6.001	.438	4000-6001-438ETAN	TA	NBR
4.000	6.250	.563	9705 H1L5	LPD	NBR
4.000	6.251	.438	4000-6250-438ETAN	TA	NBR
4.000	6.299	.563	14259 H1L5	LPDW	NBR
4.000	6.875	.250	12398 H1L5	SS	NBR
4.000	6.875	.250	12398 H1L5	SS	NBR
4.003	5.751	.500	13266 ALLL5	MCL	NBR
4.032	5.032	.438	0403 10468	SPLIT	NBR
4.032	5.032	.563	0403 9473	SPLIT	NBR
4.050	5.792	.350	17193 ALLL5	MISC	NBR
4.060	4.700	.313	18917 472	P	FKM
4.062	5.125	.469	9879 H1L21	RPD	EPDM
4.062	5.125	.469	9879 H1L5	RPD	NBR
4.062	5.125	.469	9879 H5L16	RPD	FKM
4.063	4.813	.250	18434	P	XNBR
4.063	5.007	.375	5711 H1L5	RPD	NBR
4.063	5.007	.375	5711 H5L16	RPD	FKM
4.063	5.063	.438	0406 10468	SPLIT	NBR
4.063	5.125	.375	5912 H1L5	RUP	NBR
4.063	5.125	.375	5912 H1L5 PTFE	RUP	N/P
4.063	5.125	.625	0406 12376	SPLIT	NBR
4.063	5.250	.469	10484 H1L20	RPD	XNBR
4.063	5.250	.469	10484 H1L5	RPD	NBR
4.063	5.313	.500	0406 9556	SPLIT	NBR
4.063	5.500	.663	15574 H1L5	LUP	NBR
4.063	5.625	.500	0406 11779	SPLIT	NBR
4.063	6.129	.469	11786 H1L5	RPD	NBR
4.063	6.250	.500	9583 H1L5	OLRPD	NBR
4.087	5.087	.500	0408 10788	SPLIT	NBR
4.094	4.844	.563	0409 10042	SPLIT	NBR
4.094	4.969	.500	0409 17022	SPLIT	NBR
4.094	5.094	.563	0409 9473	SPLIT	NBR
4.094	5.594	.750	0409 9472	SPLIT	NBR
4.100	4.750	.250	19888 H1L7	SS	NBR
4.115	5.115	.438	0411 10468	SPLIT	NBR
4.118	5.118	.563	0411 9473	SPLIT	NBR
4.120	5.375	.250	9197 H1L5	B	NBR
4.125	4.813	.250	16101 H1L5	OLSS	NBR
4.125	4.875	.563	0412 10042	SPLIT	NBR
4.125	4.912	.472	0412 14484	SPLIT	NBR
4.125	5.000	.438	17228 H1L5	LUP	NBR
4.125	5.000	.438	17228 H5L16	LUP	FKM
4.125	5.000	.500	0412 17022	SPLIT	NBR
4.125	5.000	.500	0412 17022 V	SPLIT	FKM
4.125	5.000	.750	12686 H1L5	P	NBR
4.125	5.000	.750	12686 H1L7	P	NBR
4.125	5.028	.197	19317 H1L5	SS	NBR
4.125	5.063	.406	13358 H1L5	OLSS	NBR
4.125	5.125	.438	0412 10468	SPLIT	NBR
4.125	5.125	.438	0412 10468 V	SPLIT	FKM
4.125	5.125	.438	0412 3588	SPLIT	NBR

Shaft Dia.	Bore Dia.	Seal Width	Parker Part Number	Seal Type	Material
4.125	5.125	.438	0412 3588 V	SPLIT	FKM
4.125	5.125	.500	11790 H1L20	LUP	XNBR
4.125	5.125	.500	11790 H1L5	LUP	NBR
4.125	5.125	.500	11790 H1L7 PTFE	LUP	N/P
4.125	5.125	.500	11790 H5L16	LUP	FKM
4.125	5.125	.500	10175 H1L2160	RUP	EPDM
4.125	5.125	.500	10175 H1L5	RUP	NBR
4.125	5.125	.500	10175 H5L16	RUP	FKM
4.125	5.125	.500	0412 4350	SPLIT	NBR
4.125	5.125	.500	0412 6618	SPLIT	NBR
4.125	5.125	.500	0412 6618 V	SPLIT	FKM
4.125	5.125	.563	0412 9473	SPLIT	NBR
4.125	5.125	.688	14142 H1L5	LPDW	NBR
4.125	5.188	.625	0412 12376	SPLIT	NBR
4.125	5.250	.469	10382 H1L5	LPD	NBR
4.125	5.250	.469	10382 H5L16	LPD	FKM
4.125	5.250	.500	11194 H1L5	LPD	NBR
4.125	5.250	.500	11194 H5L16	LPD	FKM
4.125	5.250	.500	0412 16002	SPLIT	NBR
4.125	5.250	.500	0412 4406	SPLIT	NBR
4.125	5.250	.500	0412 4406 V	SPLIT	FKM
4.125	5.250	.563	11739 H1L5	LPD	NBR
4.125	5.250	.563	11739 H5L16	LPD	FKM
4.125	5.250	.625	14444 H1L5	LDS	NBR
4.125	5.250	.625	9649 H1L5	LPD	NBR
4.125	5.250	.625	9649 H5L89	LPD	FKM
4.125	5.375	.500	0412 9556	SPLIT	NBR
4.125	5.375	.625	12339 H1L5	LPD	NBR
4.125	5.438	.375	0412 8813	SPLIT	NBR
4.125	5.500	.563	6582 H1L5	LUP	NBR
4.125	5.500	.563	6582 H5L16	LUP	FKM
4.125	5.625	.500	16604 H1L5	LUP	NBR
4.125	5.625	.500	5823 H1L5	RUP	NBR
4.125	5.625	.500	5823 H5L16	RUP	FKM
4.125	5.625	.625	0412 15219	SPLIT	NBR
4.125	5.625	.750	0412 9472	SPLIT	NBR
4.125	5.625	.750	19232 H1L5	RUPW	NBR
4.125	5.688	.500	0412 11779	SPLIT	NBR
4.125	5.750	.663	11120 H1L5	LPD	NBR
4.125	5.750	.663	11120 H5MX5489	LPD	FKM
4.125	6.000	.625	16043 H1L5	SSW	NBR
4.128	4.875	.250	10988 414	DS	CR
4.132	5.132	.563	0413 9473	SPLIT	NBR
4.132	5.195	.625	0413 12376	SPLIT	NBR
4.134	4.724	.472	15123	P	XNBR
4.134	5.118	.591	20707 H5L89	LUP	FKM
4.134	5.709	.591	18378 H1L5	LUP	NBR
4.136	5.325	.500	0413 13153	SPLIT	NBR
4.138	5.500	.656	18163 5066	HP	FKM
4.149	5.118	.468	TMAL 5118-3031	TMAL	PTFE
4.156	5.157	.563	0415 9473	SPLIT	NBR
4.156	5.407	.500	0415 9556	SPLIT	NBR
4.160	5.220	.625	0416 12376	SPLIT	NBR
4.164	6.000	1.625	15101 H1L5	LPD	NBR
4.185	4.937	.438	19967 5066	HP	FKM
4.187	6.250	.562	TMAL 6250-3666	TMAL	PTFE
4.188	5.000	.469	6263 H1L5	LA	NBR
4.188	5.001	.375	0418 8473	SPLIT	NBR
4.188	5.187	.500	0418 6618	SPLIT	NBR
4.188	5.188	.625	11436 414	DS	CR
4.188	5.188	.438	0418 3588	SPLIT	NBR
4.188	5.188	.500	5924 H1L5	LUP	NBR
4.188	5.188	.500	5924 H5L16	LUP	FKM
4.188	5.188	.563	0418 9473	SPLIT	NBR
4.188	5.235	.306	17393 H1L5	LUPW	NBR
4.188	5.250	.469	9800 H1L5	LPD	NBR

See Section 4 for seal type description. For High Misalignment sizes, see Page B-86. For FlexiSeal Listings, see Pages B-93 and B-97.

03/03/06





Shaft Dia.	Bore Dia.	Seal Width	Parker Part Number	Seal Type	Material
4.188	5.250	.469	9800 H5L16	LPD	FKM
4.188	5.250	.500	0418 11084	SPLIT	NBR
4.188	5.250	.500	0418 11084 V	SPLIT	FKM
4.188	5.250	.625	0418 12376	SPLIT	NBR
4.188	5.260	.625	12122 H1L5	LPD	NBR
4.188	5.438	.500	0418 9556	SPLIT	NBR
4.188	5.500	.375	0418 8813	SPLIT	NBR
4.188	5.500	.562	0418 10447	SPLIT	NBR
4.188	5.500	.563	18564 H1L5	LPD	NBR
4.188	5.500	.563	18564 H5L16	LPD	FKM
4.188	5.680	.750	0418 11906	SPLIT	NBR
4.188	5.688	.625	0418 15219	SPLIT	NBR
4.188	5.688	.625	0418 15219 V	SPLIT	FKM
4.188	5.750	.500	0418 11779	SPLIT	NBR
4.188	6.000	.625	16547 H1L5	LUP	NBR
4.188	6.000	.625	16547 H5L16	LUP	FKM
4.188	6.250	.583	11643 H1L5	LPD	NBR
4.188	6.250	.583	11643 H5L16	LPD	FKM
4.188	6.373	.625	11517 H1L5	LPD	NBR
4.188	6.500	.563	8808 H1L5	LUP	NBR
4.188	6.500	.563	8808 H5L16	LUP	FKM
4.190	5.250	.500	0419 11084 V	SPLIT	FKM
4.196	5.250	.625	4452 H1L5	RPD	NBR
4.205	5.433	.590	19576 H1L5	RUP	NBR
4.219	6.000	.688	19350 412	DS	CR
4.225	5.000	.375	19491	MP	FKM
4.250	5.000	.250	11274 H1L5	SSW	NBR
4.250	5.000	.250	11274 H1L5 PTFE	SSW	N/P
4.250	5.000	.375	0425 14983	SPLIT	NBR
4.250	5.000	.375	15373 5066	HP	FKM
4.250	5.000	.375	15373 5066 304	HP	FKM
4.250	5.000	.375	15373 5066 316	HP	FKM
4.250	5.000	.375	17968 5066	HP	FKM
4.250	5.000	.375	17968 5066 304	HP	FKM
4.250	5.000	.375	17968 5066 316	HP	FKM
4.250	5.000	.375	19433	MP	FKM
4.250	5.000	.375	19877 5201 MP	MP	FKM
4.250	5.000	.375	17212 H1L5	OLSS	NBR
4.250	5.000	.375	17988 H1L5	OLSS	NBR
4.250	5.000	.375	17988 H5L16	OLSS	FKM
4.250	5.000	.410	13454 ALLL7	P	NBR
4.250	5.000	.438	10490 H1L5	LUP	NBR
4.250	5.000	.438	10490 H5L16	LUP	FKM
4.250	5.000	.438	10490 H5L16 PTF	LUP	F/P
4.250	5.000	.563	10042 H1L2160	RPD	EPDM
4.250	5.000	.563	10042 H1L5	RPD	NBR
4.250	5.063	.375	0425 8473	SPLIT	NBR
4.250	5.125	.500	17022 H1L5	RUP	NBR
4.250	5.125	.500	17022 H5L16	RUP	FKM
4.250	5.189	.313	6394 2460	DS	EPDM
4.250	5.189	.313	6394 414	DS	CR
4.250	5.250	.250	TMAS 5250-1632	TMAS	PTFE
4.250	5.250	.375	TMAS 5250-2432	TMAS	PTFE
4.250	5.250	.438	3591 H1L5	B	NBR
4.250	5.250	.438	7187 H1L5	LUP	NBR
4.250	5.250	.438	7187 H1L5 PTFE	LUP	N/P
4.250	5.250	.438	7187 H1L7	LUP	NBR
4.250	5.250	.438	7187 H5L16	LUP	FKM
4.250	5.250	.438	7187 H5MX5489	LUP	FKM
4.250	5.250	.438	17856 H1L5	LUPW	NBR
4.250	5.250	.438	10468 H1L5	RPD	NBR
4.250	5.250	.438	10468 H1L5 PTFE	RPD	N/P
4.250	5.250	.438	10468 H5L16	RPD	FKM
4.250	5.250	.438	0425 3588	SPLIT	NBR
4.250	5.250	.438	0425 3588 V	SPLIT	FKM
4.250	5.250	.438	0425 5868 V	SPLIT	FKM

Shaft Dia.	Bore Dia.	Seal Width	Parker Part Number	Seal Type	Material
4.250	5.250	.500	17063 H1L5	H	NBR
4.250	5.250	.500	13653 H1L5	LPDW	NBR
4.250	5.250	.500	13653 H5L89	LPDW	FKM
4.250	5.250	.500	10655 H1L5	OLLPD	NBR
4.250	5.250	.500	0425 6618	SPLIT	NBR
4.250	5.250	.500	0425 6618 V	SPLIT	FKM
4.250	5.250	.500	TMAL 5250-3232	TMAL	PTFE
4.250	5.250	.563	0425 9473	SPLIT	NBR
4.250	5.250	.563	0425 9473 V	SPLIT	FKM
4.250	5.250	.563	0425 9473 L7	SPLIT	NBR
4.250	5.250	.625	15415 H1L5	LDS	NBR
4.250	5.250	.625	15415 H5L16	LDS	FKM
4.250	5.250	.625	10073 H1L5	LPD	NBR
4.250	5.250	.625	5905 H1L5	LPD	NBR
4.250	5.250	.625	5905 H5L16	LPD	FKM
4.250	5.250	.625	11140 H1L7	SS	NBR
4.250	5.260	.500	7040 H1L5	LUP	NBR
4.250	5.260	.500	7040 H5L16	LUP	FKM
4.250	5.260	.500	7040 H5L16 PTFE	LUP	F/P
4.250	5.266	.500	0425 9210	SPLIT	NBR
4.250	5.313	.500	0425 11084	SPLIT	NBR
4.250	5.315	.625	0425 12376	SPLIT	NBR
4.250	5.375	.406	0425 16002	SPLIT	NBR
4.250	5.375	.500	0425 4406	SPLIT	NBR
4.250	5.375	.563	10428 H1L5	LPDW	NBR
4.250	5.376	.500	9930 H1L5	LUP	NBR
4.250	5.376	.500	9930 H5L16	LUP	FKM
4.250	5.500	.375	0425 11648	SPLIT	NBR
4.250	5.500	.500	10334 H1L5	LPD	NBR
4.250	5.500	.500	10334 H1L5 PTFE	LPD	N/P
4.250	5.500	.500	10334 H5L16	LPD	FKM
4.250	5.500	.500	10334 H5L16PTFE	LPD	F/P
4.250	5.500	.500	0425 5295	SPLIT	NBR
4.250	5.500	.500	0425 5295 V	SPLIT	FKM
4.250	5.500	.500	0425 9556	SPLIT	NBR
4.250	5.500	.500	TMAL 5500-3240	TMAL	PTFE
4.250	5.500	.562	8946 H1L20	LPD	XNBR
4.250	5.500	.562	8946 H1L5	LPD	NBR
4.250	5.500	.562	8946 H5L16	LPD	FKM
4.250	5.500	.625	5468 H1L5	B	NBR
4.250	5.500	.625	15628 H1L5	LDS	NBR
4.250	5.500	.625	0425 9468	SPLIT	NBR
4.250	5.625	.500	16598 H1L5	LUP	NBR
4.250	5.688	.484	0425 18703	SPLIT	NBR
4.250	5.750	.440	14602 414	DS	414
4.250	5.750	.563	8809 H1L5	LPD	NBR
4.250	5.750	.563	8809 H5L16	LPD	FKM
4.250	5.750	.625	0425 15219	SPLIT	NBR
4.250	5.750	.750	0425 11906	SPLIT	NBR
4.250	5.750	.750	9472 H1L5	RUP	NBR
4.250	5.875	.250	6652 H1L7	SS	NBR
4.250	5.875	.250	6652 H5L16	SS	FKM
4.250	5.906	.563	11758 H1L5	LUP	NBR
4.250	6.000	.525	14377 H1L5	LDS	NBR
4.250	6.000	.563	0425 6955	SPLIT	NBR
4.250	6.000	.563	8810 H1L5	LUP	NBR
4.250	6.000	.625	8834 H1L5	OLR	NBR
4.250	6.000	.719	13013 H1L5	LPDW	NBR
4.250	6.063	.625	10864 H1L5	OLLPD	NBR
4.250	6.219	.500	19071 H1L5	RPD	NBR
4.250	6.250	.560	13772 H1L5	LPD	NBR
4.250	8.250	1.000	13430 ALLL5	RPD	NBR
4.282	5.032	.375	0428 14983	SPLIT	NBR
4.282	5.280	.438	0428 3588	SPLIT	NBR
4.312	5.500	.546	TMAL 5500-3538	TMAL	PTFE
4.312	5.500	.562	TMAL 5500-3638	TMAL	PTFE

See Section 4 for seal type description. For High Misalignment sizes, see Page B-86.
For FlexiSeal Listings, see Pages B-93 and B-97.

03/03/06



Rotary Lip Seal Inch Sizes

4.313 to 4.438

B

Shaft Dia.	Bore Dia.	Seal Width	Parker Part Number	Seal Type	Material
4.313	5.125	.375	0431 8473	SPLIT	NBR
4.313	5.313	.438	0431 3588	SPLIT	NBR
4.313	5.313	.438	0431 3588 V	SPLIT	FKM
4.313	5.313	.500	0431 6618	SPLIT	NBR
4.313	5.313	.500	0431 6618 V	SPLIT	FKM
4.313	5.375	.500	0431 11084	SPLIT	NBR
4.313	5.375	.625	12376 H1L5	RUP	NBR
4.313	5.500	.500	0431 10047	SPLIT	NBR
4.313	5.500	.563	16548 H1L5	LUP	NBR
4.313	5.500	.563	16548 H5L16	LUP	FKM
4.313	5.500	.563	16548 H5L89	LUP	FKM
4.313	5.563	.500	0431 5295	SPLIT	NBR
4.313	5.563	.625	0431 9468	SPLIT	NBR
4.313	5.625	.562	0431 10447	SPLIT	NBR
4.313	5.625	.500	4430 H1L5	LPD	NBR
4.313	5.750	.484	0431 18703	SPLIT	NBR
4.313	5.750	.625	7192 H1L5	LPD	NBR
4.313	5.813	.750	0431 9709	SPLIT	NBR
4.313	5.875	.500	11779 H1L5	RPD	NBR
4.313	5.875	.625	0431 17141	SPLIT	NBR
4.313	6.250	.600	9545 H1L5	LPD	NBR
4.322	5.511	.469	70007 H1L5	TSS	NBR
4.323	5.323	.438	0432 3588	SPLIT	NBR
4.323	5.512	.500	13153 H1L5	RPD	NBR
4.323	5.512	.500	13153 H5L89	RPD	FKM
4.327	5.390	.500	0432 11084	SPLIT	NBR
4.328	5.577	.500	0432 5295	SPLIT	NBR
4.330	5.330	.500	0433 6618	SPLIT	NBR
4.330	5.512	.472	30018 H5MX5489	LUP	FKM
4.330	5.905	.629	30028 H1L5	LUP	NBR
4.330	5.906	.512	15323 H1L2160	RUP	EPDM
4.330	5.906	.512	15323 H1L5	RUP	NBR
4.330	5.906	.512	15323 H5L16	RUP	FKM
4.330	6.102	.591	15144 H1L5	SSW	NBR
4.330	7.087	.500	13282 H1L5	LDS	NBR
4.331	4.922	.472	15857 H1L7	P	NBR
4.331	5.118	.374	20779 5202	MP	FKM
4.331	5.118	.512	16433 H1L5	LUP	NBR
4.331	5.118	.512	16433 H5L16	LUP	FKM
4.331	5.393	.500	0433 11084	SPLIT	NBR
4.331	6.693	.500	60001 ALLL5	SPC	NBR
4.344	5.094	.375	0434 14983	SPLIT	NBR
4.344	5.156	.375	0434 8473	SPLIT	NBR
4.344	5.344	.500	0434 6618	SPLIT	NBR
4.344	5.359	.500	0434 9210	SPLIT	NBR
4.344	5.407	.500	0434 11084	SPLIT	NBR
4.344	5.532	.500	0434 10047	SPLIT	NBR
4.372	5.752	.544	10470 H1L5	LPD	NBR
4.372	5.752	.544	10470 H5L16	LPD	FKM
4.375	4.875	.250	19703 H1L5	SS	NBR
4.375	4.875	.250	19703 H5L16	SS	FKM
4.375	5.125	.375	0437 14983	SPLIT	NBR
4.375	5.125	.375	0437 14983 V	SPLIT	FKM
4.375	5.188	.375	0437 8473	SPLIT	NBR
4.375	5.375	.438	0437 3588	SPLIT	NBR
4.375	5.375	.438	0437 5868	SPLIT	NBR
4.375	5.375	.469	13378 H1L5	OLLPD	NBR
4.375	5.375	.500	4350 H1L5	B	NBR
4.375	5.375	.500	15412 H1L5	RPD	NBR
4.375	5.375	.500	0437 6618	SPLIT	NBR
4.375	5.375	.500	12896 H1L5	SSW	NBR
4.375	5.375	.500	12896 H5L16	SSW	FKM
4.375	5.375	.500	17758 H1L5	SSW	NBR
4.375	5.375	.500	17999 H1L5	SSW	NBR
4.375	5.375	.500	17999 H5MX5489	SSW	FKM
4.375	5.375	.563	9418 H1L2160	LPD	EPDM

Shaft Dia.	Bore Dia.	Seal Width	Parker Part Number	Seal Type	Material
4.375	5.375	.563	9418 H1L5	LPD	NBR
4.375	5.375	.563	9418 H5L16	LPD	FKM
4.375	5.375	.563	9473 H1L5	RPD	NBR
4.375	5.375	.563	9473 H1L7	RPD	NBR
4.375	5.375	.563	9473 H5L16	RPD	FKM
4.375	5.375	.594	12600 H1L7	P	NBR
4.375	5.375	.694	18449 H1L5	RUP	NBR
4.375	5.438	.500	0437 11084	SPLIT	NBR
4.375	5.500	.406	16002 H1L5	RPD	NBR
4.375	5.500	.406	16002 H5L16	RPD	FKM
4.375	5.500	.500	4406 H1L5	RPD	NBR
4.375	5.500	.500	4406 H5L16	RPD	FKM
4.375	5.500	.563	8875 H1L2160	LUP	EPDM
4.375	5.500	.563	8875 H1L5	LUP	NBR
4.375	5.500	.563	8875 H5L16	LUP	FKM
4.375	5.500	.563	8875 H5MX5489	LUP	FKM
4.375	5.500	.563	7076 H1L2160	OLRUP	EPDM
4.375	5.500	.563	7076 H1L5	OLRUP	NBR
4.375	5.500	.563	7076 H5L16	OLRUP	FKM
4.375	5.563	.500	0437 10047	SPLIT	NBR
4.375	5.620	.375	11648 ALLL5	RPDT	NBR
4.375	5.625	.500	19127 H1L5	LDS	NBR
4.375	5.625	.500	0437 5295	SPLIT	NBR
4.375	5.625	.500	12542 H1L5	SSW	NBR
4.375	5.625	.625	0437 8860	SPLIT	NBR
4.375	5.626	.500	9556 H1L5	RPD	NBR
4.375	5.626	.500	9556 H5L16	RPD	FKM
4.375	5.688	.562	0437 10447	SPLIT	NBR
4.375	5.750	.500	10482 H1L5	LPD	NBR
4.375	5.750	.500	10482 H5L16	LPD	FKM
4.375	5.750	.500	10482 H1L21	LPD	EPDM
4.375	5.813	.484	0437 18703	SPLIT	NBR
4.375	5.875	.313	13377 H1L5	OLSS	NBR
4.375	5.875	.313	13377 H1L7	OLSS	NBR
4.375	5.875	.625	15219 H1L5	RUP	NBR
4.375	5.875	.625	15219 H5L16	RUP	FKM
4.375	5.875	.625	15219 H5L89	RUP	FKM
4.375	5.875	.750	11906 H1L5	RPD	NBR
4.375	5.938	.625	0437 17141	SPLIT	NBR
4.375	6.125	.500	16784 H1L5	LDS	NBR
4.375	6.125	.625	0437 5260	SPLIT	NBR
4.375	6.290	.563	9590 H1L5	LPD	NBR
4.375	6.625	.500	TMAL 6625-3272	TMAL	PTFE
4.380	5.130	.563	9726 H3L8	OLSS	CR
4.393	5.705	.563	0439 6260	SPLIT	NBR
4.401	5.370	.500	TN 5370-3231	TN	N/P
4.410	5.375	.625	18842 H1L5	SDS	NBR
4.410	5.375	.625	19064 H1L5	SDS	NBR
4.410	5.375	.625	19195 H1L5	SDS	NBR
4.420	5.420	.438	0442 5868	SPLIT	NBR
4.430	5.750	.562	20472 H5MX5489	LUP	FKM
4.432	5.313	.375	9581 H1L5	LPD	NBR
4.432	7.087	.471	10378 H1L5	LPD	NBR
4.437	5.500	.500	TMAL 5500-3234	TMAL	PTFE
4.438	5.500	.531	15897 5066	HP	FKM
4.438	5.188	.375	0443 14983	SPLIT	NBR
4.438	5.250	.375	0443 8473	SPLIT	NBR
4.438	5.250	.375	0443 8473 V	SPLIT	FKM
4.438	5.250	.375	13888 H1L5	LPD	NBR
4.438	5.375	.313	7204 414	DS	CR
4.438	5.438	.250	9082 414	DS	CR
4.438	5.438	.250	9082 472	DS	FKM
4.438	5.438	.438	19162 H1L5	LUP	NBR
4.438	5.438	.438	0443 5868	SPLIT	NBR
4.438	5.438	.438	0443 5868 V	SPLIT	FKM

See Section 4 for seal type description. For High Misalignment sizes, see Page B-86. For FlexiSeal Listings, see Pages B-93 and B-97.

03/03/06



B

Shaft Dia.	Bore Dia.	Seal Width	Parker Part Number	Seal Type	Material
4.438	5.438	.500	0443 6618	SPLIT	NBR
4.438	5.438	.500	TMAL 5438-3232	TMAL	PTFE
4.438	5.500	.500	19592 ALLL20	SPC	XNBR
4.438	5.500	.500	0443 11084	SPLIT	NBR
4.438	5.500	.500	0443 11084 V	SPLIT	FKM
4.438	5.500	.500	0443 12903	SPLIT	NBR
4.438	5.500	.563	11296 H1L5	LPDW	NBR
4.438	5.500	.563	11296 H1L5 PTFE	LPDW	N/P
4.438	5.500	.563	11296 H5L16	LPDW	FKM
4.438	5.500	.563	18852 446	LUP	FAB
4.438	5.500	.563	8460 H1L5	LUP	NBR
4.438	5.500	.563	8460 H1L5 PTFE	LUP	N/P
4.438	5.500	.563	8460 H5L16	LUP	FKM
4.438	5.500	.563	8460 H5L16 PTFE	LUP	F/P
4.438	5.500	.600	10332 H1L5	LPD	NBR
4.438	5.500	.600	10332 H1L5 PTFE	LPD	N/P
4.438	5.500	.600	10332 H5L16	LPD	FKM
4.438	5.625	.500	0443 10047	SPLIT	NBR
4.438	5.625	.500	0443 10047 V	SPLIT	FKM
4.438	5.625	.625	12589 H1L5	LPD	NBR
4.438	5.625	.625	12589 H5L16	LPD	FKM
4.438	5.687	.625	0443 9468	SPLIT	NBR
4.438	5.687	.625	0443 9468 V	SPLIT	FKM
4.438	5.688	.500	0443 6382	SPLIT	NBR
4.438	5.750	.375	8813 H1L5	RPD	NBR
4.438	5.750	.562	0443 10447	SPLIT	NBR
4.438	5.750	.562	0443 10447 V	SPLIT	FKM
4.438	5.750	.563	8825 H1L5	LUP	NBR
4.438	5.875	.484	0443 18703	SPLIT	NBR
4.438	5.937	.750	0443 9561	SPLIT	NBR
4.438	5.938	.500	0443 16707	SPLIT	NBR
4.438	6.000	.625	0443 17141	SPLIT	NBR
4.438	6.188	.563	0443 6955	SPLIT	NBR
4.443	5.506	.500	TMAL 5506-3234	TMAL	PTFE
4.456	5.243	.472	14484 H1L5	RUP	NBR
4.469	5.469	.438	0446 5868	SPLIT	NBR
4.484	6.626	1.625	5096 H1L5	LPD	NBR
4.485	5.485	.500	0448 6618	SPLIT	NBR
4.488	5.738	.625	0448 9468	SPLIT	NBR
4.498	5.516	.500	9210 H1L5	RPD	NBR
4.500	5.250	.250	TMAL 5250-1624	TMAL	PTFE
4.500	5.250	.375	12826 H1L7	H	NBR
4.500	5.250	.375	17675 H1L5	LPD	NBR
4.500	5.250	.375	17675 H1L5 PTFE	LPD	N/P
4.500	5.250	.375	17675 H5L16	LPD	FKM
4.500	5.250	.375	4168 H1L20 PTFE	LUP	XNBR
4.500	5.250	.375	4168 H1L5	LUP	NBR
4.500	5.250	.375	4168 H1L5 PTFE	LUP	N/P
4.500	5.250	.375	4168 H1L70	LUP	NBR
4.500	5.250	.375	4168 H5L16	LUP	FKM
4.500	5.250	.375	4168 H5L16 PTFE	LUP	F/P
4.500	5.250	.375	19142 415	P	415
4.500	5.250	.375	0450 14983	SPLIT	NBR
4.500	5.250	.375	TMAS 5250-2424	TMAS	PTFE
4.500	5.250	.438	4235 H1L5	B	NBR
4.500	5.500	.250	13441 H1L7	SS	NBR
4.500	5.500	.313	9308 414	DS	CR
4.500	5.500	.400	60032 H1L5	LDS	NBR
4.500	5.500	.438	3588 H1L5	RUP	NBR
4.500	5.500	.438	3588 H5L16	RUP	FKM
4.500	5.500	.438	0450 17064	SPLIT	NBR
4.500	5.500	.438	0450 5868	SPLIT	NBR
4.500	5.500	.438	0450 5868 V	SPLIT	FKM
4.500	5.500	.472	16393 ALLL7	P	NBR
4.500	5.500	.472	16393 H1L7 PTFE	P	N/P
4.500	5.500	.500	12502 H1L7	H	NBR

Shaft Dia.	Bore Dia.	Seal Width	Parker Part Number	Seal Type	Material
4.500	5.500	.500	13172 H1L5	LDS	NBR
4.500	5.500	.500	13172 H1L5 PTFE	LDS	N/P
4.500	5.500	.500	13172 H5L16	LDS	FKM
4.500	5.500	.500	17824 H1L5	LPD	NBR
4.500	5.500	.500	17824 H5L89	LPD	FKM
4.500	5.500	.500	10354 H1L5	LPDW	NBR
4.500	5.500	.500	10354 H1L5 PTFE	LPDW	N/P
4.500	5.500	.500	10354 H5L16	LPDW	FKM
4.500	5.500	.500	9170 H1L20	LUP	XNBR
4.500	5.500	.500	9170 H1L2160	LUP	EPDM
4.500	5.500	.500	9170 H1L5	LUP	NBR
4.500	5.500	.500	9170 H1L5 PTFE	LUP	N/P
4.500	5.500	.500	9170 H1L70	LUP	NBR
4.500	5.500	.500	9170 H1MX9508	LUP	HNBR
4.500	5.500	.500	9170 H5/MX5489	LUP	FKM
4.500	5.500	.500	9170 H5L16	LUP	FKM
4.500	5.500	.500	19483 5202	MP	FKM
4.500	5.500	.500	0450 6618	SPLIT	NBR
4.500	5.500	.500	0450 6618 V	SPLIT	FKM
4.500	5.500	.500	0450 9737	SPLIT	NBR
4.500	5.500	.500	TMAL 5500-3232	TMAL	PTFE
4.500	5.500	.563	4519 H1L5	LUP	NBR
4.500	5.500	.563	4519 H1L5 PTFE	LUP	N/P
4.500	5.500	.563	4519 H5L16	LUP	FKM
4.500	5.500	.563	4519 HL15	LUP	NBR
4.500	5.500	.563	0450 4769	SPLIT	NBR
4.500	5.500	.563	0450 4769 V	SPLIT	FKM
4.500	5.563	.500	0450 12903	SPLIT	NBR
4.500	5.625	.250	10494 414	DS	CR
4.500	5.625	.563	11832 H1L5	LUP	NBR
4.500	5.625	.563	11832 H1L5 PTFE	LUP	N/P
4.500	5.625	.563	0450 5322	SPLIT	NBR
4.500	5.625	.563	0450 5322 V	SPLIT	FKM
4.500	5.625	.563	0450 17632	SPLIT	NBR
4.500	5.625	.563	0450 6682	SPLIT	NBR
4.500	5.625	.625	6100 H1L5	LPD	NBR
4.500	5.720	.313	9903 414	DS	CR
4.500	5.750	.375	9425 H1L7	SS	NBR
4.500	5.750	.375	TMAL 5750-2440	TMAL	PTFE
4.500	5.750	.500	7191 H1L5	LPD	NBR
4.500	5.750	.500	7191 H1L5 PTFE	LPD	N/P
4.500	5.750	.500	7191 H5L16	LPD	FKM
4.500	5.750	.500	5295 H1L5	RPD	NBR
4.500	5.750	.500	5295 H1L5 PTFE	RPD	N/P
4.500	5.750	.500	5295 H5L16	RPD	FKM
4.500	5.750	.500	0450 6382	SPLIT	NBR
4.500	5.750	.500	TMAL 5750-3240	TMAL	PTFE
4.500	5.750	.500	TMAS 5750-3240	TMAS	PTFE
4.500	5.750	.562	11709 H1L5	LUP	NBR
4.500	5.750	.562	11709 H5L16	LUP	FKM
4.500	5.750	.563	0450 9236	SPLIT	NBR
4.500	5.750	.625	0450 8860 PTFE	SPLIT	N/P
4.500	5.750	.625	15787 5066	HP	FKM
4.500	5.750	.625	15787 5066 304	HP	FKM
4.500	5.750	.625	15787 5066 316	HP	FKM
4.500	5.750	.625	7145 ALLL5	LPD	NBR
4.500	5.750	.625	7145 H1L5	LPD	NBR
4.500	5.750	.625	7145 H5L16	LPD	FKM
4.500	5.750	.625	0450 8860	SPLIT	NBR
4.500	5.750	.625	0450 8860 V	SPLIT	FKM
4.500	5.750	.625	0450 9468	SPLIT	NBR
4.500	6.000	.500	19349 412	DS	CR
4.500	6.000	.500	18058 H1L5	LDS	NBR
4.500	6.000	.500	0450 16707	SPLIT	NBR
4.500	6.000	.500	0450 16707 V	SPLIT	FKM
4.500	6.000	.500	19355 H1L5	SSW	NBR

See Section 4 for seal type description. For High Misalignment sizes, see Page B-86. For FlexiSeal Listings, see Pages B-93 and B-97.

03/03/06



Rotary Lip Seal Inch Sizes

4.500 to 4.625

B

Shaft Dia.	Bore Dia.	Seal Width	Parker Part Number	Seal Type	Material
4.500	6.000	.563	12269 H1L5	LPDW	NBR
4.500	6.000	.563	12269 H5MX5489	LPDW	FKM
4.500	6.000	.600	9664 H1L5	LUP	NBR
4.500	6.000	.600	9664 H1L5 PTFE	LUP	N/P
4.500	6.000	.600	9664 H5L16	LUP	FKM
4.500	6.000	.625	6538 H1L5	LPD	NBR
4.500	6.000	.750	9709 H1L5	RPD	NBR
4.500	6.000	.750	0450 14177	SPLIT	NBR
4.500	6.000	.750	0450 7165	SPLIT	NBR
4.500	6.005	.500	18396 446	LUP	FAB
4.500	6.063	.625	0450 17141	SPLIT	NBR
4.500	6.125	.500	0450 4924	SPLIT	NBR
4.500	6.250	.563	7360 H1L5	LPD	NBR
4.500	6.250	.563	7360 H5L16	LPD	FKM
4.500	6.250	.563	0450 6955	SPLIT	NBR
4.500	6.250	.563	0450 6955 V	SPLIT	FKM
4.500	6.375	.563	5991 H1L5	LUP	NBR
4.500	6.437	.500	14930 ALLL5	MISC	NBR
4.500	6.500	.750	17272 H1L5	SSW	NBR
4.500	6.500	.750	17272 H1L5 PTFE	SSW	N/P
4.500	6.500	.750	17272 H5L16	SSW	FKM
4.500	6.500	.750	17772 5066	SSW	FKM
4.500	6.500	.750	17772 5066 304	SSW	FKM
4.500	6.500	.750	17772 5066 316	SSW	FKM
4.526	5.513	.500	NCS81151	MISC	NBR
4.527	5.512	.472	16926 H1L5	LPD	NBR
4.527	5.512	.472	16926 H5L16	LPD	FKM
4.527	5.984	.590	12770 H1L5	LPD	NBR
4.530	7.087	.313	17578 H1L5	LUPEL	NBR
4.532	5.282	.375	0453 17162	SPLIT	NBR
4.532	5.532	.500	0453 9737	SPLIT	NBR
4.532	5.532	.563	0453 4769	SPLIT	NBR
4.532	5.594	.500	0453 12903	SPLIT	NBR
4.532	5.719	.500	0453 10047	SPLIT	NBR
4.532	5.782	.625	0453 8860	SPLIT	NBR
4.532	6.157	.500	0453 4924	SPLIT	NBR
4.535	7.087	.465	17578 H1L5 (Special)	LUPW-EL	NBR
4.550	6.175	.500	0455 4924	SPLIT	NBR
4.561	6.931	.500	15636 H1L5	LUP	NBR
4.562	5.750	.625	TMAL 5750-4038	TMAL	PTFE
4.563	5.313	.375	0456 17162	SPLIT	NBR
4.563	5.375	.375	8473 H1L5	RUP	NBR
4.563	5.375	.375	8473 H5L16	RUP	FKM
4.563	5.563	.375	16773 ALLL16	SS	FKM
4.563	5.563	.500	0456 9737	SPLIT	NBR
4.563	5.622	.563	11084 H1L2160	LPD	EPDM
4.563	5.622	.563	11084 H1L5	LPD	NBR
4.563	5.622	.563	11084 H5L16	LPD	FKM
4.563	5.625	.500	0456 12903	SPLIT	NBR
4.563	5.625	.500	0456 3696	SPLIT	NBR
4.563	5.750	.500	0456 10047	SPLIT	NBR
4.563	5.750	.563	15070 H1L5	LPDW	NBR
4.563	5.750	.563	15070 H5L16	LPDW	FKM
4.563	5.750	.563	16816 446	LUP	FAB
4.563	5.750	.563	16816 H5L16	LUP	FKM
4.563	5.813	.625	0456 8860	SPLIT	NBR
4.563	5.875	.563	0456 5143	SPLIT	NBR
4.563	5.875	.562	10447 H1L5	RPD	NBR
4.563	5.875	.562	10447 H5L16	RPD	FKM
4.563	6.000	.484	18703 H1L5	RUP	NBR
4.563	6.063	.500	0456 16707	SPLIT	NBR
4.563	6.063	.750	9561 H1L5	RPD	NBR
4.563	6.188	.500	0456 4924	SPLIT	NBR
4.563	6.350	.481	13234 ALLL16	LPDW	FKM
4.563	6.350	.481	13234 ALLL5	LPDW	FKM
4.594	5.594	.563	0459 4769	SPLIT	NBR

Shaft Dia.	Bore Dia.	Seal Width	Parker Part Number	Seal Type	Material
4.594	5.844	.625	0459 8860	SPLIT	NBR
4.598	5.816	.590	19575 H1L5	RUP	NBR
4.600	6.250	.562	2005 H1L5	LUP	NBR
4.600	6.250	.562	2005 H5L16	LUP	FKM
4.625	5.375	.313	9850 H1L5	LPD	NBR
4.625	5.375	.375	8971 H1L5	LUP	NBR
4.625	5.375	.375	14983 H1L5	RPD	NBR
4.625	5.375	.375	14983 H1L70	RPD	NBR
4.625	5.375	.375	14983 H5L16	RPD	FKM
4.625	5.375	.375	0462 17162	SPLIT	NBR
4.625	5.407	.375	0462 17424	SPLIT	NBR
4.625	5.500	.500	10154 H1L5	LUP	NBR
4.625	5.500	.500	10154 H5L16	LUP	FKM
4.625	5.500	.563	16605 H1L5	LUP	NBR
4.625	5.625	.435	3726 H1L5	RPD	NBR
4.625	5.625	.438	17064 H1L5	RPD	NBR
4.625	5.625	.438	5193 H1L5	LPD	NBR
4.625	5.625	.438	5868 H1L5	R	NBR
4.625	5.625	.438	5868 H5L16	R	FKM
4.625	5.625	.500	17385 5066	HP	FKM
4.625	5.625	.500	17385 5066 304	HP	FKM
4.625	5.625	.500	17385 5066 316	HP	FKM
4.625	5.625	.500	13173 H1L5	LDS	NBR
4.625	5.625	.500	11368 H1L5	LUP	NBR
4.625	5.625	.500	11368 H5L16	LUP	FKM
4.625	5.625	.500	6618 H1L5	RPD	NBR
4.625	5.625	.500	6618 H5L16	RPD	FKM
4.625	5.625	.500	0462 9737	SPLIT	NBR
4.625	5.625	.500	0462 9737 V	SPLIT	FKM
4.625	5.625	.500	TMAL 5625-3232	TMAL	PTFE
4.625	5.625	.563	0462 4769	SPLIT	NBR
4.625	5.687	.500	0462 12903 V	SPLIT	FKM
4.625	5.688	.500	0462 12903	SPLIT	NBR
4.625	5.750	.469	10132 H1L5	LPD	NBR
4.625	5.750	.469	10132 H5L16	LPD	FKM
4.625	5.750	.562	5594 H1L5	LUP	NBR
4.625	5.750	.562	5594 H5L16	LUP	FKM
4.625	5.750	.563	0462 17632	SPLIT	NBR
4.625	5.750	.563	0462 5322	SPLIT	NBR
4.625	5.875	.500	6382 H1L5	RUP	NBR
4.625	5.875	.500	6382 H5L16	RUP	FKM
4.625	5.875	.563	0462 4212	SPLIT	NBR
4.625	5.875	.625	6677 H1L5	LA	NBR
4.625	5.875	.625	9468 H1L5	RUP	NBR
4.625	5.875	.625	9468 H1L5 PTFE	RUP	N/P
4.625	5.875	.625	9468 H5L16	RUP	FKM
4.625	5.875	.625	0462 8860	SPLIT	NBR
4.625	6.000	.625	9361 H1L5	LPD	NBR
4.625	6.000	.625	9361 H5MX5489	LPD	FKM
4.625	6.000	.625	16932 H1L5	OLLUP	NBR
4.625	6.004	.591	0462 15310	SPLIT	NBR
4.625	6.120	.750	15792 ALLL5	RPDT	NBR
4.625	6.125	.500	0462 16707	SPLIT	NBR
4.625	6.125	.500	16685 H1L5	LUP	NBR
4.625	6.125	.563	12271 H1L5	LPD	NBR
4.625	6.125	.750	0462 7165	SPLIT	NBR
4.625	6.125	.750	14177 H1L5	RPD	NBR
4.625	6.188	.625	0462 12544	SPLIT	NBR
4.625	6.200	.438	18029 H1L5	SSW	NBR
4.625	6.250	.500	8811 H1L5	LUP	NBR
4.625	6.250	.500	8811 H5MX5489	LUP	FKM
4.625	6.250	.500	0462 4924	SPLIT	NBR
4.625	6.250	.563	0462 12111	SPLIT	NBR
4.625	6.375	.484	10023 H1L5	LUP	NBR
4.625	6.375	.563	6955 H1L5	R	NBR
4.625	6.375	.563	6955 H5L16	R	FKM

See Section 4 for seal type description. For High Misalignment sizes, see Page B-86. For FlexiSeal Listings, see Pages B-93 and B-97.

03/03/06





Shaft Dia.	Bore Dia.	Seal Width	Parker Part Number	Seal Type	Material
4.625	6.375	.625	0462 13340	SPLIT	NBR
4.625	6.376	.625	5260 H1L5	R	NBR
4.656	5.407	.375	0465 18284	SPLIT	NBR
4.656	5.719	.500	0465 12903	SPLIT	NBR
4.656	5.907	.563	0465 4212	SPLIT	NBR
4.675	6.300	.500	0467 4924	SPLIT	NBR
4.688	5.688	.500	19316 H1L5	LUP	NBR
4.688	5.688	.500	19316 H5L16	LUP	FKM
4.688	5.688	.500	0468 9737	SPLIT	NBR
4.688	5.688	.500	TMAL 5688-3232	TMAL	PTFE
4.688	5.750	.438	12060 H1L5	LPD	NBR
4.688	5.750	.500	12861 H1L5	LPD	NBR
4.688	5.750	.500	12861 H5L16	LPD	FKM
4.688	5.750	.500	3696 H1L5	RPD	NBR
4.688	5.750	.500	3696 H5L16	RPD	FKM
4.688	5.750	.500	0468 12903	SPLIT	NBR
4.688	5.750	.563	8900 H1L5	LPD	NBR
4.688	5.750	.563	8900 H5L16	LPD	FKM
4.688	5.756	.563	8478 H1L5	LPD	NBR
4.688	5.813	.563	0468 5322	SPLIT	NBR
4.688	5.875	.500	10047 H1L5	RPD	NBR
4.688	5.938	.625	0468 6585	SPLIT	NBR
4.688	6.000	.438	0468 5651	SPLIT	NBR
4.688	6.000	.563	0468 5143	SPLIT	NBR
4.688	6.250	.563	6743 H1L5	LA	NBR
4.688	6.250	.625	0468 12544	SPLIT	NBR
4.688	6.250	.625	17141 H1L5	RUP	NBR
4.688	8.750	.500	19366 H1L5	LUP	NBR
4.719	5.469	.375	0471 18284	SPLIT	NBR
4.719	5.719	.500	0471 9737	SPLIT	NBR
4.719	5.781	.500	0471 16497	SPLIT	NBR
4.719	6.032	.563	0471 5143	SPLIT	NBR
4.719	6.282	.625	0471 12544	SPLIT	NBR
4.720	5.849	.625	0472 16029	SPLIT	NBR
4.720	6.097	.591	0472 15310	SPLIT	NBR
4.720	6.345	.500	0472 4924	SPLIT	NBR
4.724	5.315	.472	15225 H1L7	P	NBR
4.724	5.512	.512	15175 H1L5	RUP	NBR
4.724	5.512	.512	15175 H5L16	RUP	FKM
4.724	5.906	.591	15324 H1L5	RPD	NBR
4.724	5.906	.591	15324 H1L70	RPD	NBR
4.724	5.906	.591	15324 H5L16	RPD	FKM
4.724	5.906	.630	19754 H1L70	LUP	NBR
4.724	6.299	.472	15209 H1L5	LUP	NBR
4.725	5.725	.500	0472 9737	SPLIT	NBR
4.730	5.980	.563	0473 9236	SPLIT	NBR
4.750	5.250	.375	12937 H1L5	LPD	NBR
4.750	5.500	.375	17969 5066	HP	FKM
4.750	5.500	.375	17969 5066 304	HP	FKM
4.750	5.500	.375	17969 5066 316	HP	FKM
4.750	5.500	.375	11856 H1L5	LDS	NBR
4.750	5.500	.375	11856 H5MX5489	LDS	FKM
4.750	5.500	.375	9549 H1L5	LUP	NBR
4.750	5.500	.375	9549 H1L5 PTFE	LUP	N/P
4.750	5.500	.375	9549 H5L16	LUP	FKM
4.750	5.500	.375	17162 H1L5	RUP	NBR
4.750	5.500	.375	0475 18284	SPLIT	NBR
4.750	5.500	.375	0475 18284 V	SPLIT	FKM
4.750	5.750	.438	0475 3727	SPLIT	NBR
4.750	5.750	.500	3827 H1L5	B	NBR
4.750	5.750	.500	9820 H1L5	LUP	NBR
4.750	5.750	.500	9820 H1L5 PTFE	LUP	N/P
4.750	5.750	.500	9820 H5L16	LUP	FKM
4.750	5.750	.500	16222 H1L5	LUPW	NBR
4.750	5.750	.500	16222 H5L16	LUPW	FKM
4.750	5.750	.500	0475 10788	SPLIT	NBR

Shaft Dia.	Bore Dia.	Seal Width	Parker Part Number	Seal Type	Material
4.750	5.750	.500	0475 9737	SPLIT	NBR
4.750	5.750	.500	0475 9737 V	SPLIT	FKM
4.750	5.750	.562	9963 H1L5	LPD	NBR
4.750	5.750	.562	9963 H5L16	LPD	FKM
4.750	5.750	.563	0475 4769	SPLIT	NBR
4.750	5.750	.563	0475 4769 V	SPLIT	FKM
4.750	5.750	.750	12687 H1L5	P	NBR
4.750	5.750	.750	12687 H1L7	P	NBR
4.750	5.750	.750	12687 H5L16	P	FKM
4.750	5.875	.500	11226 H1L5	LPD	NBR
4.750	5.875	.500	11226 H5L16	LPD	FKM
4.750	5.875	.563	0475 5322	SPLIT	NBR
4.750	5.875	.625	0475 4484	SPLIT	NBR
4.750	6.000	.500	17025 H1L5	OLLUP	NBR
4.750	6.000	.563	0475 4212	SPLIT	NBR
4.750	6.000	.625	14265 H1L5	B	NBR
4.750	6.000	.625	6935 H1L5	LPD	NBR
4.750	6.000	.625	6935 H5L16	LPD	FKM
4.750	6.000	.625	8860 H1L5	RUP	NBR
4.750	6.000	.625	8860 H5MX5489	RUP	FKM
4.750	6.000	.625	0475 6585	SPLIT	NBR
4.750	6.063	.438	0475 5651	SPLIT	NBR
4.750	6.063	.563	0475 5143	SPLIT	NBR
4.750	6.063	.563	0475 6260	SPLIT	NBR
4.750	6.250	.500	11804 H1L5	LPD	NBR
4.750	6.250	.500	11804 H5L16	LPD	FKM
4.750	6.250	.500	16707 H1L5	RUP	NBR
4.750	6.250	.500	16707 H5L16	RUP	FKM
4.750	6.250	.500	TMAL 6250-3248	TMAL	PTFE
4.750	6.250	.563	6085 9010L21	LPD	EPDM
4.750	6.250	.563	6085 H1L5	LPD	NBR
4.750	6.250	.563	6085 H5L16	LPD	FKM
4.750	6.250	.563	0475 4037	SPLIT	NBR
4.750	6.250	.625	7107 H1L5	LA	NBR
4.750	6.250	.750	7165 H1L5	RUP	NBR
4.750	6.250	.750	7165 H5L16	RUP	FKM
4.750	6.375	.500	0475 4924	SPLIT	NBR
4.750	6.375	.563	12111 H1L5	RPD	NBR
4.750	6.500	.625	14379 H1L5	LDS	NBR
4.750	6.500	.625	8812 H1L5	LUP	NBR
4.750	6.500	.625	8812 H5L16	LUP	FKM
4.750	6.500	.625	8812 H5MX5489	LUP	FKM
4.750	6.500	.625	0475 13340	SPLIT	NBR
4.750	6.500	.781	12766 H1L5	LPDW	NBR
4.750	6.625	.625	10841 H1L5	LPD	NBR
4.750	7.250	.500	0475 11735	SPLIT	NBR
4.772	6.000	.531	70008 H1L5	TSS	NBR
4.772	6.000	.531	70008 H1L50	TSS	NBR
4.781	5.563	.375	0478 17424	SPLIT	NBR
4.781	5.843	.500	0478 16497	SPLIT	NBR
4.781	5.875	.500	0478 9737	SPLIT	NBR
4.813	6.250	.625	9434 H1L50	LPDW	NBR
4.813	5.594	.375	0481 17424	SPLIT	NBR
4.813	5.812	.375	0481 12543	SPLIT	NBR
4.813	5.813	.375	12543 H1L5	LUP	NBR
4.813	5.813	.500	0481 9737	SPLIT	NBR
4.813	5.813	.500	0481 9737 V	SPLIT	FKM
4.813	5.875	.500	12903 H1L5	RPD	NBR
4.813	5.875	.500	12903 H5L16	RPD	FKM
4.813	5.875	.500	0481 16497	SPLIT	NBR
4.813	6.000	.792	14647 H1L5	LPDW	NBR
4.813	6.250	.500	11060 H1L5	LPD	NBR
4.813	6.250	.625	9434 H1L5	LPDW	NBR
4.813	6.250	1.058	18017 H1L5	EL	NBR
4.830	5.830	.500	0483 9737	SPLIT	NBR
4.844	5.625	.375	0484 17424	SPLIT	NBR

See Section 4 for seal type description. For High Misalignment sizes, see Page B-86. For FlexiSeal Listings, see Pages B-93 and B-97.

03/03/06



Rotary Lip Seal Inch Sizes

4.844 to 5.000

B

Shaft Dia.	Bore Dia.	Seal Width	Parker Part Number	Seal Type	Material
4.844	5.625	.375	0484 17424 V	SPLIT	FKM
4.844	5.844	.500	0484 9737	SPLIT	NBR
4.844	7.344	.500	0484 11735	SPLIT	NBR
4.859	6.109	.563	9236 H1L5	R	NBR
4.875	5.625	.375	18284 H1L21	RUP	EPDM
4.875	5.625	.375	18284 H1L5	RUP	NBR
4.875	5.625	.375	18284 H5L16	RUP	FKM
4.875	5.875	.438	0487 3727	SPLIT	NBR
4.875	5.875	.500	0487 10788	SPLIT	NBR
4.875	5.875	.500	0487 10788 V	SPLIT	FKM
4.875	5.875	.500	0487 9737	SPLIT	NBR
4.875	5.875	.500	0487 9737 V	SPLIT	FKM
4.875	5.875	.500	0487 9737 V	SPLIT	FKM
4.875	5.875	.563	4769 H1L5	RPD	NBR
4.875	5.875	.563	4769 H5MX5489	RPD	FKM
4.875	5.875	1.000	3925 H1L5	B	NBR
4.875	5.937	.500	0487 16497	SPLIT	NBR
4.875	6.000	.500	14216 H1L5	LDS	NBR
4.875	6.000	.500	15801 H1L5	LDS	NBR
4.875	6.000	.500	19205 H1L5	LUPW	NBR
4.875	6.000	.500	0487 16029	SPLIT	NBR
4.875	6.000	.500	0487 6530	SPLIT	NBR
4.875	6.000	.500	0487 6530 V	SPLIT	FKM
4.875	6.000	.563	10471 H1L5	LPD	NBR
4.875	6.000	.563	6682 H1L5	RPD	NBR
4.875	6.000	.563	5322 H1L5	RUP	NBR
4.875	6.000	.563	5322 H5L89	RUP	FKM
4.875	6.000	.563	0487 17632	SPLIT	NBR
4.875	6.000	.563	0487 17632 V	SPLIT	FKM
4.875	6.000	.625	15067 H1L5	LUP	NBR
4.875	6.000	.625	15067 H1L70	LUP	NBR
4.875	6.000	.625	15067 H5L16	LUP	FKM
4.875	6.000	.625	9784 H1L5	OLRPD	NBR
4.875	6.000	.625	0487 4484	SPLIT	NBR
4.875	6.000	.625	0487 4484 V	SPLIT	FKM
4.875	6.125	.375	11841 414	DS	CR
4.875	6.125	.500	0487 10231	SPLIT	NBR
4.875	6.125	.500	TMAL 6125-3240	TMAL	PTFE
4.875	6.125	.563	0487 4212	SPLIT	NBR
4.875	6.125	.625	8925 H1L5	LPD	NBR
4.875	6.125	.625	8925 H5L16	LPD	FKM
4.875	6.125	.625	0487 3708	SPLIT	NBR
4.875	6.125	.625	0487 6585	SPLIT	NBR
4.875	6.125	.625	0487 6585 V	SPLIT	FKM
4.875	6.188	.563	0487 6260	SPLIT	NBR
4.875	6.250	.500	7234 H1L5	LUP	NBR
4.875	6.250	.500	7234 H1L70	LUP	NBR
4.875	6.250	.500	7234 H5L16	LUP	FKM
4.875	6.250	.563	19048 H1L5	LDS	NBR
4.875	6.250	.563	0487 5649	SPLIT	NBR
4.875	6.250	.563	0487 5649 V	SPLIT	FKM
4.875	6.250	.625	9797 H1L5	LPD	NBR
4.875	6.250	.625	9797 H5L16	LPD	FKM
4.875	6.375	.500	0487 13245	SPLIT	NBR
4.875	6.375	.563	0487 4037	SPLIT	NBR
4.875	6.375	.750	0487 11487	SPLIT	NBR
4.875	6.433	.625	0487 12544	SPLIT	NBR
4.875	6.500	.500	4924 H1L5	RPD	NBR
4.875	6.500	.500	4924 H5L16	RPD	FKM
4.875	6.625	.500	18495 H1L5	LUP	NBR
4.875	6.625	.500	18495 H5L16	LUP	FKM
4.875	6.625	.625	0487 13340	SPLIT	NBR
4.875	6.687	.625	0487 12621	SPLIT	NBR
4.875	6.875	.750	9960 H1L5	LPD	NBR
4.878	5.809	.469	16924 H1L5	LUP	NBR
4.878	5.809	.469	16924 H5L16	LUP	FKM

Shaft Dia.	Bore Dia.	Seal Width	Parker Part Number	Seal Type	Material
4.881	6.194	.563	0488 6260	SPLIT	NBR
4.906	5.900	.500	0490 10788	SPLIT	NBR
4.906	5.907	.438	0490 3727	SPLIT	NBR
4.906	6.157	.563	0490 4212	SPLIT	NBR
4.920	5.750	.500	17130 H1L5	LUP	NBR
4.920	5.750	.500	17130 H5MX5489	LUP	FKM
4.920	5.905	.472	19662 H1L5	LUP	NBR
4.920	6.170	.563	0492 4212	SPLIT	NBR
4.920	6.234	.563	0492 6260	SPLIT	NBR
4.921	5.921	.500	0492 10788	SPLIT	NBR
4.922	6.299	.591	15310 H1L5	RPD	NBR
4.922	6.299	.591	15310 H5L16	RPD	FKM
4.926	6.176	.625	0492 6585	SPLIT	NBR
4.930	6.000	.563	8801 H1L5	LPD	NBR
4.937	6.000	.625	12642 H1L5	R	NBR
4.937	6.250	.563	20834 H1L5	SPEC	NBR
4.938	5.938	.438	0493 3727	SPLIT	NBR
4.938	5.938	.438	0493 3727 V	SPLIT	FKM
4.938	5.938	.500	0493 10788	SPLIT	NBR
4.938	5.938	.500	0493 10788 V	SPLIT	FKM
4.938	5.938	.500	0493 9737	SPLIT	NBR
4.938	5.985	.305	16992 H1L5	LUPW	NBR
4.938	6.000	.500	7144 H1L5	LPD	NBR
4.938	6.000	.500	7144 H1L5 PTFE	LPD	N/P
4.938	6.000	.500	7144 H5L16	LPD	FKM
4.938	6.000	.500	0493 16497	SPLIT	NBR
4.938	6.000	.625	12773 H1L5	LPD	NBR
4.938	6.000	.625	12773 H5L16	LPD	FKM
4.938	6.063	.500	0493 6530	SPLIT	NBR
4.938	6.125	.563	11990 H1L5	LPD	NBR
4.938	6.188	.563	0493 4212	SPLIT	NBR
4.938	6.188	.563	0493 4212 V	SPLIT	FKM
4.938	6.188	.625	0493 3708	SPLIT	NBR
4.938	6.188	.625	0493 6585	SPLIT	NBR
4.938	6.250	.438	5651 H1L5	RPD	NBR
4.938	6.250	.438	5651 H5L89	RPD	FKM
4.938	6.250	.500	9600 H1L5	LPD	NBR
4.938	6.250	.500	9600 H5L16	LPD	FKM
4.938	6.250	.563	9159 H1L5	LPD	NBR
4.938	6.250	.563	9159 H5L16	LPD	FKM
4.938	6.250	.563	10978 H1L5	LPDW	NBR
4.938	6.250	.563	5143 H1L5	RPD	NBR
4.938	6.250	.563	0493 6260	SPLIT	NBR
4.938	6.250	.563	0493 6260 V	SPLIT	FKM
4.938	6.250	.656	9400 H1L5	LPD	NBR
4.938	6.313	.563	0493 5649	SPLIT	NBR
4.938	6.438	.750	0493 11487	SPLIT	NBR
4.938	6.500	.625	0493 12544	SPLIT	NBR
4.940	5.937	.500	0494 9737	SPLIT	NBR
4.940	6.253	.563	0494 6260	SPLIT	NBR
4.950	6.375	.875	2028 H1L5	LUP	NBR
4.968	6.250	.500	TMAL 6250-3241	TMAL	PTFE
4.969	5.750	.375	17424 H1L5	RUP	NBR
4.969	5.750	.375	17424 H1L2160	RUP	EPDM
4.969	5.750	.375	17424 H5L16	RUP	FKM
4.969	5.969	.500	0496 10788	SPLIT	NBR
4.969	6.219	.625	0496 6585	SPLIT	NBR
4.973	6.750	.625	11005 H1L5	OLRPD	NBR
4.991	6.209	.590	19574 H1L5	RUP	NBR
5.000	5.625	.250	18943 ALLL5	H	NBR
5.000	5.625	.438	12944 H1L20	P	XNBR
5.000	5.625	.438	12944 H1L7	P	NBR
5.000	5.625	.438	12944 H5L16	P	FKM
5.000	5.625	.438	14503 ALLL7	P	NBR
5.000	5.625	.438	18287 ALLL7	P	NBR
5.000	5.750	.375	12825 H1L7	H	NBR

See Section 4 for seal type description. For High Misalignment sizes, see Page B-86. For FlexiSeal Listings, see Pages B-93 and B-97.

03/03/06



B

Shaft Dia.	Bore Dia.	Seal Width	Parker Part Number	Seal Type	Material
5.000	5.750	.375	12825 H5L16	H	FKM
5.000	5.750	.375	17164 H1L5	LUP	NBR
5.000	5.750	.375	17164 H5L16	LUP	FKM
5.000	5.750	.375	0500 3768	SPLIT	NBR
5.000	5.750	.375	0500 3768 V	SPLIT	FKM
5.000	5.750	.375	7127 H1L5	SS	NBR
5.000	5.750	.375	7127 H1L7	SS	NBR
5.000	5.750	.375	7127 H5L16	SS	FKM
5.000	5.750	.375	TMAL 5750-2424	TMAL	PTFE
5.000	5.750	.438	9333 H1L5	LUP	NBR
5.000	5.750	.438	9333 H1L7	LUP	NBR
5.000	5.750	.438	9333 H5L16	LUP	FKM
5.000	5.750	.438	4497 H1L5	RPD	NBR
5.000	6.000	.375	12897 H1L5	SSW	NBR
5.000	6.000	.375	17611 H1L5	SSW	NBR
5.000	6.000	.375	18271 H1L5	SSW	NBR
5.000	6.000	.375	18271 H1L7	SSW	NBR
5.000	6.000	.410	16642 ALLL7	P	NBR
5.000	6.000	.438	0500 3727	SPLIT	NBR
5.000	6.000	.438	0500 3727 V	SPLIT	FKM
5.000	6.000	.500	12031 H1L5	H	NBR
5.000	6.000	.500	12031 H1L7	H	NBR
5.000	6.000	.500	16740 H1L5	LDS	NBR
5.000	6.000	.500	16740 H5L16	LDS	FKM
5.000	6.000	.500	9629 H1L2160	LUP	EPDM
5.000	6.000	.500	9629 H1L5	LUP	NBR
5.000	6.000	.500	9629 H5L16	LUP	FKM
5.000	6.000	.500	9629 H5MX5489	LUP	FKM
5.000	6.000	.500	9737 H1L2160	RPD	EPDM
5.000	6.000	.500	9737 H1L5	RPD	NBR
5.000	6.000	.500	9737 H5L16	RPD	FKM
5.000	6.000	.500	0500 10788	SPLIT	NBR
5.000	6.000	.500	0500 10788 V	SPLIT	FKM
5.000	6.000	.500	0500 12188	SPLIT	NBR
5.000	6.000	.500	0500 12188 V	SPLIT	FKM
5.000	6.000	.500	TMAL 6000-3232	TMAL	PTFE
5.000	6.000	.625	9530 H1L5	LUP	NBR
5.000	6.000	.625	9530 H5L16	LUP	FKM
5.000	6.063	.500	0500 5356	SPLIT	NBR
5.000	6.125	.375	10731 414	DS	NBR
5.000	6.125	.500	15154 H1L5	LPDW	NBR
5.000	6.125	.500	15154 H5MX5489	LPDW	FKM
5.000	6.125	.500	0500 6530	SPLIT	NBR
5.000	6.125	.500	0500 6530 V	SPLIT	FKM
5.000	6.125	.563	17632 H1L5	RUP	NBR
5.000	6.125	.563	17632 H5L16	RUP	FKM
5.000	6.125	.625	0500 4484	SPLIT	NBR
5.000	6.125	.625	16029 H1L5	RPD	NBR
5.000	6.250	.375	18243 ALLL5	RPDT	NBR
5.000	6.250	.500	5907 H1L5	LPD	NBR
5.000	6.250	.500	5907 H1L70	LPD	NBR
5.000	6.250	.500	5907 H5L16	LPD	FKM
5.000	6.250	.500	13176 H1L5	LPDW	NBR
5.000	6.250	.500	0500 10231	SPLIT	NBR
5.000	6.250	.500	0500 10231 V	SPLIT	FKM
5.000	6.250	.562	6325 H1L5	LUP	NBR
5.000	6.250	.562	6325 H1L5 PTFE	LUP	N/P
5.000	6.250	.562	6325 H5L16	LUP	FKM
5.000	6.250	.562	6325 MX9010L21	LUP	EPDM
5.000	6.250	.563	0500 4212	SPLIT	NBR
5.000	6.250	.563	0500 4212 V	SPLIT	FKM
5.000	6.250	.625	15639 5066	HP	FKM
5.000	6.250	.625	15639 5066 304	HP	FKM
5.000	6.250	.625	15639 5066 316	HP	FKM
5.000	6.250	.625	15131 H1L5	LDS	NBR
5.000	6.250	.625	17959 H1L5	LDS	NBR

Shaft Dia.	Bore Dia.	Seal Width	Parker Part Number	Seal Type	Material
5.000	6.250	.625	18134 H1L5	LDS	NBR
5.000	6.250	.625	10201 H1L5	LPD	NBR
5.000	6.250	.625	10201 H1L7	LPD	NBR
5.000	6.250	.625	10201 H5L16	LPD	FKM
5.000	6.250	.625	10906 H1L5	LPDW	NBR
5.000	6.250	.625	10906 H5L16	LPDW	FKM
5.000	6.250	.625	0500 3708	SPLIT	NBR
5.000	6.250	.625	0500 5758	SPLIT	NBR
5.000	6.250	.625	0500 6585	SPLIT	NBR
5.000	6.250	.625	0500 6585 V	SPLIT	FKM
5.000	6.315	.563	0500 6260	SPLIT	NBR
5.000	6.375	.563	0500 5649	SPLIT	NBR
5.000	6.500	.500	20835 H1L5	LDS	NBR
5.000	6.500	.562	9044 H1L5	LUP	NBR
5.000	6.500	.562	9044 H1L2160	LUP	EPDM
5.000	6.500	.562	9044 H5L16	LUP	FKM
5.000	6.500	.563	4037 H1L5	RPD	NBR
5.000	6.500	.563	4037 H5L16	RPD	FKM
5.000	6.500	.625	6671 H1L5	LUP	NBR
5.000	6.500	.625	6671 H5L16	LUP	FKM
5.000	6.500	.750	0500 11487	SPLIT	NBR
5.000	6.750	.625	8956 H1L5	LPD	NBR
5.000	6.750	.625	0500 13340	SPLIT	NBR
5.000	6.813	.625	0500 12621	SPLIT	NBR
5.000	6.875	.625	12367 H1L5	LPD	NBR
5.000	7.000	.750	17273 ALLL7	SSW	NBR
5.000	7.000	.750	17273 H1L5	SSW	NBR
5.000	7.000	.750	17273 H5L16	SSW	FKM
5.001	6.622	1.000	13494 H1L5	LPD	NBR
5.005	6.000	.750	6110 H3L8	OLSS	CR
5.031	6.032	.500	0503 12188	SPLIT	NBR
5.031	6.282	.500	0503 10231	SPLIT	NBR
5.031	6.970	.391	18135 ALLL16	LPDW	FKM
5.031	6.970	.391	18135 ALLL5	LPDW	NBR
5.031	6.970	.391	18135 ALLL7	LPDW	NBR
5.063	6.063	.500	0506 12188	SPLIT	NBR
5.063	6.125	.500	16497 H1L5	RUP	NBR
5.063	6.125	.500	0506 5356	SPLIT	NBR
5.063	6.250	.500	0506 12116	SPLIT	NBR
5.063	6.250	.625	11852 H1L5	LPDW	NBR
5.063	6.250	.625	18961 H1L5	LDS	NBR
5.063	6.375	.563	5148 H1L5	LPD	NBR
5.063	6.375	.563	6260 H1L5	RPD	NBR
5.063	6.375	.563	6260 H5L16	RPD	FKM
5.063	6.563	.500	13245 H1L5	RPD	NBR
5.063	6.625	.625	12544 H1L5	RPD	NBR
5.063	6.875	.875	12563 H1L5	RPD	NBR
5.063	7.000	1.313	15531 H1L5	LUP	NBR
5.063	7.875	.500	0506 16086	SPLIT	NBR
5.089	6.348	.406	16693 H1L5	LUP	NBR
5.094	6.094	.438	0509 3727	SPLIT	NBR
5.094	6.094	.500	0509 12188	SPLIT	NBR
5.094	6.219	.500	0509 6530	SPLIT	NBR
5.103	6.103	.500	0510 12188	SPLIT	NBR
5.114	6.114	.500	0511 12188	SPLIT	NBR
5.117	6.367	.500	0511 10231	SPLIT	NBR
5.118	5.709	.472	14659 H1L7	P	NBR
5.118	6.299	.472	19814 H1L5	LUP	NBR
5.118	6.299	.472	19814 H5L89	LUP	FKM
5.118	6.299	.590	15033 H1L5	LPD	NBR
5.118	6.299	.590	15033 H5MX5489	LPD	FKM
5.118	6.299	.591	18529 H1L5	LUP	NBR
5.118	6.299	.591	18529 H1L5 PTFE	LUP	N/P
5.118	6.693	.591	15312 H1L5	RUP	NBR
5.120	6.375	.563	9476 H1L5	OLRPD	NBR
5.120	6.375	.563	9476 H5L16	OLRPD	FKM

See Section 4 for seal type description. For High Misalignment sizes, see Page B-86.
For FlexiSeal Listings, see Pages B-93 and B-97.

03/03/06



Rotary Lip Seal Inch Sizes

5.120 to 5.250

B

Shaft Dia.	Bore Dia.	Seal Width	Parker Part Number	Seal Type	Material
5.120	6.375	.563	9476 H5MX5489	OLRPD	FKM
5.125	5.875	.375	4705 H1L5	B	NBR
5.125	5.875	.375	0512 3768	SPLIT	NBR
5.125	5.875	.375	0512 3768 V	SPLIT	FKM
5.125	6.125	.438	0512 3727	SPLIT	NBR
5.125	6.125	.438	0512 3727 V	SPLIT	FKM
5.125	6.125	.500	12270 H1L21	LUP	EPDM
5.125	6.125	.500	12270 H1L5	LUP	NBR
5.125	6.125	.500	12270 H5L16	LUP	FKM
5.125	6.125	.500	16223 H1L5	LUPW	NBR
5.125	6.125	.500	16223 H5L16	LUPW	FKM
5.125	6.125	.500	6141 H1L5	OLLUP	NBR
5.125	6.125	.500	6141 H5L16	OLLUP	FKM
5.125	6.125	.500	6141 MX9510L21	OLLUP	EPDM
5.125	6.125	.500	10788 H1L5	RUP	NBR
5.125	6.125	.500	10788 H1L7	RUP	NBR
5.125	6.125	.500	10788 H5L16	RUP	FKM
5.125	6.125	.500	0512 12188	SPLIT	NBR
5.125	6.125	.500	0512 12188 V	SPLIT	FKM
5.125	6.250	.500	0512 6530	SPLIT	NBR
5.125	6.250	.500	0512 6530 V	SPLIT	FKM
5.125	6.250	.625	0512 4484	SPLIT	NBR
5.125	6.313	.500	0512 12116	SPLIT	NBR
5.125	6.375	.500	0512 10231	SPLIT	NBR
5.125	6.375	.500	0512 10231 V	SPLIT	FKM
5.125	6.375	.563	10017 H1L5	LPD	NBR
5.125	6.375	.563	4212 H1L5	RPD	NBR
5.125	6.375	.563	4212 H5L16	RPD	FKM
5.125	6.375	.563	4212 H5MX5489	RPD	FKM
5.125	6.375	.625	0512 3708	SPLIT	NBR
5.125	6.375	.625	0512 5758	SPLIT	NBR
5.125	6.375	.625	10151 H1L5	LUP	NBR
5.125	6.375	.625	10151 H5L16	LUP	FKM
5.125	6.375	.625	13595 H1L5	LDS	NBR
5.125	6.375	.625	6585 H1L5	RPD	NBR
5.125	6.375	.625	6585 H5L16	RPD	FKM
5.125	6.500	.563	0512 5649	SPLIT	NBR
5.125	6.500	.625	7335 H1L5	LPD	NBR
5.125	6.500	.625	7335 H5L16	LPD	FKM
5.125	6.625	.750	0512 10786	SPLIT	NBR
5.125	6.625	.750	0512 11487	SPLIT	NBR
5.125	6.762	.625	0512 4286	SPLIT	NBR
5.125	6.875	.625	13340 H1L5	RPD	NBR
5.125	6.938	.625	12621 H1L5	RPD	NBR
5.160	6.437	.400	14759 ALLL7	LPD	NBR
5.160	6.437	.400	14759 ALLL89	LPD	FKM
5.160	6.437	.400	15253 ALLL7	LPD	NBR
5.160	6.437	.400	15253 ALLL89	LPD	FKM
5.180	5.875	.430	19842 H5L16	LUP	FKM
5.180	6.688	.500	7093 H1L5	B	NBR
5.180	9.188	1.000	13645 ALLL5	RPD	NBR
5.188	5.875	.438	9367 H1L5	LUP	NBR
5.188	5.938	.375	0518 3768	SPLIT	NBR
5.188	6.188	.500	0518 12188	SPLIT	NBR
5.188	6.188	.500	0518 12256	SPLIT	NBR
5.188	6.250	.500	13174 H1L5	LDS	NBR
5.188	6.250	.500	13174 H5L16	LDS	FKM
5.188	6.250	.500	11369 H1L5	LUP	NBR
5.188	6.250	.500	11369 H5L16	LUP	FKM
5.188	6.250	.500	0518 5356	SPLIT	NBR
5.188	6.250	.500	0518 5356 V	SPLIT	FKM
5.188	6.299	.472	18746 H1L5	RUP	NBR
5.188	6.313	.500	0518 6530	SPLIT	NBR
5.188	6.375	.375	16355 414	DS	CR
5.188	6.375	.500	0518 12116	SPLIT	NBR
5.188	6.438	.625	0518 3918	SPLIT	NBR

Shaft Dia.	Bore Dia.	Seal Width	Parker Part Number	Seal Type	Material
5.188	6.500	.500	7336 H1L5	LPD	NBR
5.188	6.500	.500	7336 H5L16	LPD	FKM
5.188	6.500	.500	7336 H5MX5489	LPD	FKM
5.188	6.500	.563	8826 H1L5	LPD	NBR
5.188	6.563	.563	0518 5649	SPLIT	NBR
5.188	6.688	.750	0518 10786	SPLIT	NBR
5.188	6.750	.500	19356 H1L5	SSW	NBR
5.188	6.750	.500	19356 H5L16	SSW	FKM
5.188	7.688	.500	11735 H1L5	RPD	NBR
5.188	8.000	.500	16086 H1L5	RUP	NBR
5.219	5.969	.375	0521 3768	SPLIT	NBR
5.219	6.219	.500	0521 12188	SPLIT	NBR
5.219	6.344	.500	0521 6530	SPLIT	NBR
5.219	6.719	.750	0521 10786	SPLIT	NBR
5.219	6.719	.750	0521 10786 V	SPLIT	FKM
5.220	6.500	.625	3929 H1L5	B	NBR
5.230	6.417	.591	0523 18745	SPLIT	NBR
5.243	6.424	.472	9957 H1L5	RPD	NBR
5.243	6.424	.472	9957 H5L16	RPD	FKM
5.248	7.375	.625	10816 H1L5	SSW	NBR
5.250	6.000	.375	0525 3768	SPLIT	NBR
5.250	6.000	.375	0525 3768 V	SPLIT	FKM
5.250	6.000	.410	11916 H1L5	P	NBR
5.250	6.125	.500	15176 H1L5	LUP	NBR
5.250	6.125	.500	15176 H5L16	LUP	FKM
5.250	6.250	.438	3727 H1L5	RPD	NBR
5.250	6.250	.438	3727 H1L5 PTFE	RPD	N/P
5.250	6.250	.438	3727 H5L16	RPD	FKM
5.250	6.250	.438	0525 9155	SPLIT	NBR
5.250	6.250	.500	7042 H1L5	LUP	NBR
5.250	6.250	.500	7042 H1L5 PTFE	LUP	N/P
5.250	6.250	.500	7042 H5L16	LUP	FKM
5.250	6.250	.500	7042 H5L16 PTFE	LUP	F/P
5.250	6.250	.500	18897 ALLL5	SPC	NBR
5.250	6.250	.500	0525 12188	SPLIT	NBR
5.250	6.250	.500	0525 12188 V	SPLIT	FKM
5.250	6.250	.500	0525 12256	SPLIT	NBR
5.250	6.250	.750	6768 H3L8	OLSS	CR
5.250	6.375	.188	11831 414	DS	CR
5.250	6.375	.500	0525 6530	SPLIT	NBR
5.250	6.375	.625	4484 H1L5	RPD	NBR
5.250	6.375	.625	4484 H1L5 PTFE	RPD	N/P
5.250	6.375	.625	4484 H5L16	RPD	FKM
5.250	6.438	.500	0525 12116	SPLIT	NBR
5.250	6.438	.500	0525 12116 V	SPLIT	FKM
5.250	6.500	.500	0525 10231	SPLIT	NBR
5.250	6.500	.562	14634 H1L5	LPD	NBR
5.250	6.500	.562	14634 H5L16	LPD	FKM
5.250	6.500	.562	20412 H1L5	LPDW	NBR
5.250	6.500	.625	14446 H1L7	H	NBR
5.250	6.500	.625	14446 H5L16	H	FKM
5.250	6.500	.625	7112 H1L5	LUP	NBR
5.250	6.500	.625	7112 H5L16	LUP	FKM
5.250	6.500	.625	3708 H1L5	RUP	NBR
5.250	6.500	.625	0525 11070	SPLIT	NBR
5.250	6.500	.625	0525 3918	SPLIT	NBR
5.250	6.500	.625	0525 3918 V	SPLIT	FKM
5.250	6.500	.625	0525 5758	SPLIT	NBR
5.250	6.500	.625	0525 5758 V	SPLIT	FKM
5.250	6.625	.563	0525 5649	SPLIT	NBR
5.250	6.750	.625	9964 H1L5	LPD	NBR
5.250	6.750	.625	9964 H5L16	LPD	FKM
5.250	6.750	.625	20416 H5MX5489	LUPW	FKM
5.250	6.750	.625	17473 H1L5	SSW	NBR
5.250	6.750	.750	0525 10786	SPLIT	NBR
5.250	6.764	.564	14211 ALLL5	LPDW	NBR

See Section 4 for seal type description. For High Misalignment sizes, see Page B-86. For FlexiSeal Listings, see Pages B-93 and B-97.

03/03/06



B

Shaft Dia.	Bore Dia.	Seal Width	Parker Part Number	Seal Type	Material
5.250	6.764	.564	17394 ALLL16	LPDW	FKM
5.250	6.764	.564	17394 H1L5	LPDW	NBR
5.250	6.812	1.056	17951 H5MX5489	LPDW-EL	FKM
5.250	6.813	1.056	17951 H1L5	LPDW	NBR
5.250	7.000	.500	14133 H1L5	LUP	NBR
5.250	7.000	.625	14378 H1L5	LDS	NBR
5.250	7.250	.625	18501 H1L5 PTFE	LUP	N/P
5.250	7.250	.625	18501 H5L16	LUP	FKM
5.250	7.250	.625	18501 HL15	LUP	NBR
5.250	7.313	.625	0525 9002	SPLIT	NBR
5.260	6.510	.625	0526 5758	SPLIT	NBR
5.282	6.282	.500	0528 12256	SPLIT	NBR
5.282	6.532	.500	0528 10231	SPLIT	NBR
5.282	6.532	.625	0528 5758	SPLIT	NBR
5.290	6.040	.375	0529 3768	SPLIT	NBR
5.297	6.547	.625	0529 5758	SPLIT	NBR
5.313	6.063	.375	0531 3768	SPLIT	NBR
5.313	6.063	.375	0531 3768 V	SPLIT	FKM
5.313	6.250	.750	14884 H1L5	LPD	NBR
5.313	6.313	.438	5085 H1L21	RPD	EPDM
5.313	6.313	.438	5085 H1L5	RPD	NBR
5.313	6.313	.438	0531 3944	SPLIT	NBR
5.313	6.313	.500	0531 12256	SPLIT	NBR
5.313	6.375	.500	5356 H1L5	RUP	NBR
5.313	6.375	.500	5356 H5MX5489	RUP	FKM
5.313	6.438	.500	0531 10746	SPLIT	NBR
5.313	6.500	.500	0531 12116	SPLIT	NBR
5.313	6.562	.625	0531 11070	SPLIT	NBR
5.313	6.562	.625	0531 4286	SPLIT	NBR
5.313	6.563	.500	0531 10231	SPLIT	NBR
5.313	6.563	.625	0531 5758	SPLIT	NBR
5.313	6.563	.625	0531 7179	SPLIT	NBR
5.313	6.813	.750	0531 10786	SPLIT	NBR
5.313	7.352	.563	10644 H1L5	SSW	NBR
5.313	7.375	.625	0531 9002	SPLIT	NBR
5.320	6.226	.375	19752 H1L5	SPEC	NBR
5.320	6.226	.375	19752 H1L50	SPEC	NBR
5.325	6.226	.375	19752 H1L70	SPEC	NBR
5.330	6.580	.500	0533 10231	SPLIT	NBR
5.344	6.344	.500	0534 12256	SPLIT	NBR
5.344	6.594	.625	0534 5758	SPLIT	NBR
5.354	6.500	.500	17306 H1L5	LUP	NBR
5.354	8.071	.512	13164 H1L5	LPD	NBR
5.360	6.682	.495	13754 ALLL16	SPCL	FKM
5.360	6.682	.495	13754 H1L7	SPCL	NBR
5.360	6.682	.495	13754 MX4629	SPCL	MX4629
5.370	8.466	.575	8876 H1L5	LPD	NBR
5.370	8.466	.575	8876 H1L5 PTFE	LPD	N/P
5.375	6.125	.375	0537 3768	SPLIT	NBR
5.375	6.125	.422	12524 ALLL7	P	NBR
5.375	6.375	.375	15543 H1L5	SSWOL	NBR
5.375	6.375	.375	18317 H1L5	SSW	NBR
5.375	6.375	.375	18317 H1L5 PTFE	SSW	N/P
5.375	6.375	.438	0537 9155	SPLIT	NBR
5.375	6.375	.500	10598 H1L5	LUP	NBR
5.375	6.375	.500	10598 H5L16	LUP	FKM
5.375	6.375	.500	12188 H1L5	RPD	NBR
5.375	6.375	.500	12188 H5L16	RPD	FKM
5.375	6.375	.500	0537 12256	SPLIT	NBR
5.375	6.375	.500	0537 6617	SPLIT	NBR
5.375	6.375	.594	12604	P	XNBR
5.375	6.500	.438	12093 414	DS	CR
5.375	6.500	.500	6530 H1L5	RPD	NBR
5.375	6.500	.500	6530 H5L16	RPD	FKM
5.375	6.500	.500	0537 10746	SPLIT	NBR
5.375	6.500	.625	16549 H1L5	LUP	NBR

Shaft Dia.	Bore Dia.	Seal Width	Parker Part Number	Seal Type	Material
5.375	6.625	.500	12089 H1L5	LPD	NBR
5.375	6.625	.500	0537 10231	SPLIT	NBR
5.375	6.625	.500	0537 10231 H1L7	SPLIT	NBR
5.375	6.625	.625	3918 H1L5	RUP	NBR
5.375	6.625	.625	3918 H5L16	RUP	FKM
5.375	6.625	.625	0537 11070	SPLIT	NBR
5.375	6.625	.625	0537 5758	SPLIT	NBR
5.375	6.750	.563	5649 H1L5	RPD	NBR
5.375	6.750	.563	5649 H5L16	RPD	FKM
5.375	6.750	.625	7193 H1L5	LPD	NBR
5.375	6.875	.750	0537 10786	SPLIT	NBR
5.375	6.875	.750	11487 H1L5	RPD	NBR
5.375	7.125	.625	16985 H1L5	LUP	NBR
5.424	6.500	.469	70009 H1L5	TSS	NBR
5.425	6.500	.360	12260 H1L7	SS	NBR
5.425	6.500	.360	12260 H5L16	SS	FKM
5.437	6.437	.500	19725 H1L5	LUP	NBR
5.438	6.187	.375	0543 3768	SPLIT	NBR
5.438	6.437	.438	0543 9155	SPLIT	NBR
5.438	6.437	.500	0543 6617	SPLIT	NBR
5.438	6.438	.375	0543 16720	SPLIT	NBR
5.438	6.438	.438	0543 3944	SPLIT	NBR
5.438	6.438	.500	0543 12256	SPLIT	NBR
5.438	6.438	.500	0543 12256 V	SPLIT	FKM
5.438	6.438	.625	0543 11070	SPLIT	NBR
5.438	6.563	.375	11247 414	DS	CR
5.438	6.625	.500	9646 H1L5	LPD	NBR
5.438	6.625	.500	9646 H1L5 PTFE	LPD	N/P
5.438	6.625	.500	9646 H1L70	LPD	NBR
5.438	6.625	.500	9646 H5L16	LPD	FKM
5.438	6.625	.500	0543 12116	SPLIT	NBR
5.438	6.688	.500	0543 10231	SPLIT	NBR
5.438	6.688	.625	0543 4286	SPLIT	NBR
5.438	6.750	.625	6764 H1L5	LPD	NBR
5.438	6.750	.625	6764 H5L16	LPD	FKM
5.438	6.750	.625	0543 11070 V	SPLIT	FKM
5.438	6.938	.750	0543 10786	SPLIT	NBR
5.438	6.938	.750	0543 10786 V	SPLIT	FKM
5.438	7.000	.563	0543 6702	SPLIT	NBR
5.438	7.500	.625	0543 9002	SPLIT	NBR
5.469	6.219	.375	0546 3768	SPLIT	NBR
5.469	6.469	.500	0546 12256	SPLIT	NBR
5.469	6.968	.750	0546 10786	SPLIT	NBR
5.497	7.508	.625	12087 H1L5	LUP	NBR
5.498	6.498	.500	0549 12256	SPLIT	NBR
5.500	6.250	.375	0550 3768	SPLIT	NBR
5.500	6.250	.375	0550 3768 V	SPLIT	FKM
5.500	6.250	.375	12819 H1L7	H	NBR
5.500	6.250	.437	TMAS 6250-2824	TMAS	PTFE
5.500	6.250	.438	4825 H1L5	LUP	NBR
5.500	6.250	.438	4825 H1L5 PTFE	LUP	N/P
5.500	6.250	.438	4825 H5L16	LUP	FKM
5.500	6.500	.438	0550 3714	SPLIT	NBR
5.500	6.500	.438	0550 3714 V	SPLIT	FKM
5.500	6.500	.438	0550 9155	SPLIT	NBR
5.500	6.500	.500	20725 H1L5	LDS	NBR
5.500	6.500	.500	5926 H1L5	LUP	NBR
5.500	6.500	.500	5926 H1L5 PTFE	LUP	N/P
5.500	6.500	.500	5926 H5L16	LUP	FKM
5.500	6.500	.500	19402 H1L5	LUPW	NBR
5.500	6.500	.500	19438 5201	MP	FKM
5.500	6.500	.500	14805 H1L30	OLLPD	HNBR
5.500	6.500	.500	14805 H1L5	OLLPD	NBR
5.500	6.500	.500	14805 H5L16	OLLPD	FKM
5.500	6.500	.500	0550 12256	SPLIT	NBR
5.500	6.500	.500	0550 12256 V	SPLIT	FKM

See Section 4 for seal type description. For High Misalignment sizes, see Page B-86.
For FlexiSeal Listings, see Pages B-93 and B-97.

03/03/06



B

Shaft Dia.	Bore Dia.	Seal Width	Parker Part Number	Seal Type	Material
5.500	6.500	.500	0550 6617	SPLIT	NBR
5.500	6.500	.500	0550 6617 V	SPLIT	FKM
5.500	6.500	.500	TMAL 6500-3232	TMAL	PTFE
5.500	6.500	.500	TMAS 6500-3232	TMAS	PTFE
5.500	6.625	.438	10539 414	DS	CR
5.500	6.625	.438	10539 H5	DS	FKM
5.500	6.625	.500	10746 H1L5	RPD	NBR
5.500	6.625	.500	TMAL 6625-3236	TMAL	PTFE
5.500	6.625	.563	0550 4337	SPLIT	NBR
5.500	6.681	.591	0550 18745 V	SPLIT	FKM
5.500	6.683	.591	0550 18745	SPLIT	NBR
5.500	6.750	.500	10231 H1L5	RPD	NBR
5.500	6.750	.500	10231 H1L7	RPD	NBR
5.500	6.750	.500	TMAL 6750-3240	TMAL	PTFE
5.500	6.750	.563	3712 H1L5	B	NBR
5.500	6.750	.563	18043 H1L20	LPD	XNBR
5.500	6.750	.563	18043 H1L5	LPD	NBR
5.500	6.750	.563	18043 H5L89	LPD	FKM
5.500	6.750	.563	7186 H1L5	LUP	NBR
5.500	6.750	.563	7186 H1L7	LUP	NBR
5.500	6.750	.563	7186 H5L16	LUP	FKM
5.500	6.750	.563	15151 446	LUP	FAB
5.500	6.750	.563	TMAL 6750-3640	TMAL	PTFE
5.500	6.750	.625	1684 H1L21	LUP	EPDM
5.500	6.750	.625	1684 H1L5	LUP	NBR
5.500	6.750	.625	1684 H1L5 PTFE	LUP	N/P
5.500	6.750	.625	1684 H5L16	LUP	FKM
5.500	6.750	.625	16239 H1L5	LUPW	NBR
5.500	6.750	.625	16239 H5L16	LUPW	FKM
5.500	6.750	.625	5758 H1L5	RPD	NBR
5.500	6.750	.625	5758 H5L16	RPD	FKM
5.500	6.750	.625	0550 11070	SPLIT	NBR
5.500	6.750	.625	0550 11070 V	SPLIT	FKM
5.500	6.750	.625	0550 4286	SPLIT	NBR
5.500	6.750	.625	0550 4286 V	SPLIT	FKM
5.500	6.750	.625	TMAS 6750-4040	TMAS	PTFE
5.500	6.750	.625	TMAS6750-4040SP	TMAS	PTFE
5.500	6.750	.750	2662 H1L5	LPD	NBR
5.500	6.750	.750	2662 H5L16	LPD	FKM
5.500	6.875	.625	10302 H1L2160	LPD	EPDM
5.500	6.875	.625	10302 H1L5	LPD	NBR
5.500	6.875	.625	10302 H5L16	LPD	FKM
5.500	7.000	.625	12446 H1L5	LPD	NBR
5.500	7.000	.625	0550 4471	SPLIT	NBR
5.500	7.000	.625	0550 4711	SPLIT	NBR
5.500	7.000	.750	13052 H1L5	LDS	NBR
5.500	7.000	.750	13052 H1L70	LDS	NBR
5.500	7.000	.750	9408 H1L5	LUP	NBR
5.500	7.000	.750	9408 H5MX5489	LUP	FKM
5.500	7.000	.750	0550 10786	SPLIT	NBR
5.500	7.062	.563	0550 6702	SPLIT	NBR
5.500	7.063	.563	0550 6702 V	SPLIT	FKM
5.500	7.125	.500	14438 H1L5	LPD	NBR
5.500	7.125	.500	16902 H1L5	OLLUP	NBR
5.500	7.250	.437	TMAS 7250-2856	TMAS	PTFE
5.500	7.250	.500	12424 H1L5	LPD	NBR
5.500	7.250	.500	12424 H5L16	LPD	FKM
5.500	7.370	.250	0550 14174	SPLIT	NBR
5.500	7.500	.500	20717 H1L5	LUP	NBR
5.500	7.563	.625	0550 9002	SPLIT	NBR
5.500	8.188	.750	20600 H1L5	LUPEL	NBR
5.500	10.250	.500	19367 H1L5	LUP	NBR
5.510	6.510	.500	0551 6617	SPLIT	NBR
5.510	6.693	.591	30079 H5L89	LUP	FKM
5.510	6.760	.625	0551 4286	SPLIT	NBR
5.512	6.693	.512	15201 H1L7	SS	NBR

Shaft Dia.	Bore Dia.	Seal Width	Parker Part Number	Seal Type	Material
5.512	6.693	.512	15201 H5L16	SS	FKM
5.512	6.693	.591	0551 18745	SPLIT	NBR
5.512	6.693	.630	19755 H1L5	LDS	NBR
5.512	6.693	.630	19755 H1L70	LDS	NBR
5.512	6.693	.630	19755 H5L89	LDS	FKM
5.512	6.752	.563	13900 H1L5	LDS	NBR
5.512	7.087	.591	15313 H1L5	RPD	NBR
5.512	8.268	.563	13280 H1L5	LDS	NBR
5.516	6.895	.472	13868 H1L5	SSW	NBR
5.519	7.093	.591	0551 15172	SPLIT	NBR
5.520	7.086	.563	0552 6702 V	SPLIT	FKM
5.532	6.782	.625	0553 4286	SPLIT	NBR
5.532	7.094	.563	0553 6702	SPLIT	NBR
5.532	7.110	.591	0553 15172	SPLIT	NBR
5.532	7.592	.875	0553 6163	SPLIT	NBR
5.561	6.500	.629	19196 H1L5	SDS	NBR
5.563	6.500	.625	17400 H1L5	SDS	NBR
5.563	6.563	.438	0556 3714	SPLIT	NBR
5.563	6.563	.500	0556 6617	SPLIT	NBR
5.563	6.750	.500	18458 H1L5	LUP	NBR
5.563	6.750	.500	12116 H1L5	RPD	NBR
5.563	6.750	.500	12116 H1L70	RPD	NBR
5.563	6.750	.500	12116 H5L16	RPD	FKM
5.563	6.813	.625	0556 4286	SPLIT	NBR
5.594	6.594	.438	0559 3714	SPLIT	NBR
5.625	6.625	.375	16720 H1L5	LDS	NBR
5.625	6.375	.375	3768 H1L5	RPD	NBR
5.625	6.375	.375	3768 H5L16	RPD	FKM
5.625	6.625	.438	0562 3714	SPLIT	NBR
5.625	6.625	.500	0562 12737	SPLIT	NBR
5.625	6.625	.500	0562 6617	SPLIT	NBR
5.625	6.625	.500	12256 H1L5	RUP	NBR
5.625	6.625	.500	12256 H5L16	RUP	FKM
5.625	6.625	.500	19166 H1L5	OLLUP	NBR
5.625	6.625	.500	6533 H1L5	LPD	NBR
5.625	6.625	.500	6533 H1L5 PTFE	LPD	N/P
5.625	6.625	.500	6533 H5L16	LPD	FKM
5.625	6.625	.500	6533 H5MX5489	LPD	FKM
5.625	6.750	.500	15509 H1L5	LPD	NBR
5.625	6.750	.500	15509 H5MX5489	LPD	FKM
5.625	6.750	.563	0562 4337	SPLIT	NBR
5.625	6.750	.563	0562 4337 V	SPLIT	FKM
5.625	6.875	.500	60015 H1L5	LDS	NBR
5.625	6.875	.563	7077 H1L5	OLRUP	NBR
5.625	6.875	.625	10152 H1L5	LUP	NBR
5.625	6.875	.625	10152 H5L89	LUP	FKM
5.625	6.875	.625	10152 H1L21	LUP	EPDM
5.625	6.875	.625	11070 H1L5	RUP	NBR
5.625	6.875	.625	11070 H5L16	RUP	FKM
5.625	6.875	.625	0562 4286	SPLIT	NBR
5.625	6.875	.625	0562 4286 L21	SPLIT	EPDM
5.625	7.000	.500	0562 9718	SPLIT	NBR
5.625	7.125	.625	0562 4711	SPLIT	NBR
5.625	7.125	.625	0562 4711 V	SPLIT	FKM
5.625	7.125	.750	10786 H1L5	RPD	NBR
5.625	7.125	.750	10786 H1L5 PTFE	RPD	N/P
5.625	7.125	.750	10786 H5L16	RPD	FKM
5.625	7.125	.750	0562 9824	SPLIT	NBR
5.625	7.187	.563	0562 6702	SPLIT	NBR
5.625	7.250	.500	15947 H1L5	LUP	NBR
5.625	7.500	.250	14174 H1L5	RPD	NBR
5.625	7.500	.625	13415 H1L5	LPD	NBR
5.625	7.688	.625	9002 H1L5	R	NBR
5.625	7.812	.688	0562 12010	SPLIT	NBR
5.688	6.688	.438	0568 3714 V	SPLIT	FKM

See Section 4 for seal type description. For High Misalignment sizes, see Page B-86. For FlexiSeal Listings, see Pages B-93 and B-97.

03/03/06



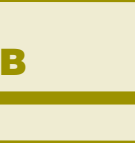

Shaft Dia.	Bore Dia.	Seal Width	Parker Part Number	Seal Type	Material
5.688	6.688	.500	0568 6617	SPLIT	NBR
5.688	6.750	.500	0568 13475	SPLIT	NBR
5.688	6.750	.625	12185 H1L5	LPD	NBR
5.688	6.805	.563	0568 4337	SPLIT	NBR
5.688	6.938	.625	0568 7179	SPLIT	NBR
5.688	7.188	.500	0568 9718	SPLIT	NBR
5.688	7.188	.750	0568 9824	SPLIT	NBR
5.719	6.719	.438	0571 3714	SPLIT	NBR
5.719	6.719	.500	0571 06617	SPLIT	NBR
5.750	6.500	.500	13649 ALLL7	P	NBR
5.750	6.625	.625	15839 H1L5	LUP	NBR
5.750	6.625	.625	15839 H5L16	LUP	FKM
5.750	6.691	.750	19692 H1L5	SS	NBR
5.750	6.691	.750	19692 H1L70	SS	NBR
5.750	6.750	.437	18542 446	LUP	FAB
5.750	6.750	.438	19518 H5L16	LUP	FKM
5.750	6.750	.438	19518 H5L16 PTF	LUP	F/P
5.750	6.750	.438	9548 H1L3	LUP	CR
5.750	6.750	.438	9548 H1L5	LUP	NBR
5.750	6.750	.438	9548 H1L5 PTFE	LUP	N/P
5.750	6.750	.438	0575 3714	SPLIT	NBR
5.750	6.750	.438	0575 3714 V	SPLIT	FKM
5.750	6.750	.438	0575 9155	SPLIT	NBR
5.750	6.750	.500	16251 H1L5	LDS	NBR
5.750	6.750	.500	16251 H5L16	LDS	FKM
5.750	6.750	.500	16748 H1L5	LUPW	NBR
5.750	6.750	.500	16748 MX9010L21	LUPW	EPDM
5.750	6.750	.500	19449 H1L20	LUPW	XNBR
5.750	6.750	.500	19449 H1L7	LUPW	NBR
5.750	6.750	.500	0575 6617	SPLIT	NBR
5.750	6.750	.575	19539 H1L5	LDS	NBR
5.750	6.750	.578	TMAL 6750-3732	TMAL	PTFE
5.750	6.750	.625	8822 H1L5	LPD	NBR
5.750	6.750	.625	8822 H5L16	LPD	FKM
5.750	6.750	.625	TMAL 6750-4032	TMAL	PTFE
5.750	6.755	.500	0575 12737	SPLIT	NBR
5.750	6.875	.563	0575 4337	SPLIT	NBR
5.750	6.931	.591	0575 18745	SPLIT	NBR
5.750	6.972	.625	0575 14968	SPLIT	NBR
5.750	7.000	.375	15804 H1L5	LUP	NBR
5.750	7.000	.375	15804 H5L16	LUP	FKM
5.750	7.000	.469	0575 18277	SPLIT	NBR
5.750	7.000	.500	14915 H1L3	LPD	CR
5.750	7.000	.500	14915 H1L5	LPD	NBR
5.750	7.000	.500	14915 H1L70	LPD	NBR
5.750	7.000	.500	14915 H5L16	LPD	FKM
5.750	7.000	.500	0575 8511	SPLIT	NBR
5.750	7.000	.563	9477 H1L3	OLRUP	CR
5.750	7.000	.563	9477 H1L5	OLRUP	NBR
5.750	7.000	.625	9165 H1L5	LUP	NBR
5.750	7.000	.625	9165 H1L70	LUP	NBR
5.750	7.000	.625	9165 H5L16	LUP	FKM
5.750	7.000	.625	17301 H1L5	LUPW	NBR
5.750	7.000	.625	4286 H1L5	RPD	NBR
5.750	7.000	.625	4286 H1L5 PTFE	RPD	N/P
5.750	7.000	.625	4286 H5L16	RPD	FKM
5.750	7.000	.625	0575 14037	SPLIT	NBR
5.750	7.000	.625	0575 7179	SPLIT	NBR
5.750	7.000	.625	0575 7179 V	SPLIT	FKM
5.750	7.008	.563	10303 H1L5	LUP	NBR
5.750	7.125	.563	13825 H1L5	LPDW	NBR
5.750	7.250	.625	7007 H1L5	LA	NBR
5.750	7.250	.625	7007 H5L16	LA	FKM
5.750	7.250	.625	7007 HL15	LA	NBR
5.750	7.250	.625	0575 15951	SPLIT	NBR
5.750	7.250	.625	0575 4711	SPLIT	NBR

Shaft Dia.	Bore Dia.	Seal Width	Parker Part Number	Seal Type	Material
5.750	7.250	.750	0575 8901	SPLIT	NBR
5.750	7.250	.750	0575 9824	SPLIT	NBR
5.750	7.253	.500	0575 9718	SPLIT	NBR
5.750	7.313	.563	0575 6702	SPLIT	NBR
5.750	7.375	.625	0575 17271	SPLIT	NBR
5.750	7.423	.564	14212 ALLL5	LPDW	NBR
5.750	7.500	.563	12423 H1L5	LPD	NBR
5.750	7.500	.563	12423 H5L16	LPD	FKM
5.750	7.500	.750	16936 H1L5	OLLUP	NBR
5.750	7.875	.625	10817 H1L5	SSW	NBR
5.750	7.875	.625	10817 H1L7	SSW	NBR
5.750	9.500	.469	13195 H1L5	LPD	NBR
5.775	7.272	.500	0577 9718	SPLIT	NBR
5.781	6.782	.500	0578 12737	SPLIT	NBR
5.800	6.862	.500	0580 13475	SPLIT	NBR
5.813	6.813	.438	0581 3714	SPLIT	NBR
5.813	6.813	.438	3944 H1L5	RPD	NBR
5.813	6.938	.563	0581 4337	SPLIT	NBR
5.813	7.062	.625	0581 7179	SPLIT	NBR
5.813	7.125	.625	15181 H1L5	STLUP	NBR
5.813	7.282	.750	0581 9824	SPLIT	NBR
5.813	7.872	.875	6163 H1L5	RUP	NBR
5.844	7.094	.625	0584 7179	SPLIT	NBR
5.870	7.375	.625	4471 H1L5	B	NBR
5.872	7.500	.562	20437 H5L89	LUPW	FKM
5.875	6.875	.438	0587 9795	SPLIT	NBR
5.875	6.875	.438	11588 H1L5	LPD	NBR
5.875	6.875	.438	11588 H5L16	LPD	FKM
5.875	6.875	.438	9155 H1L5	RUP	NBR
5.875	6.875	.438	9155 H5L16	RUP	FKM
5.875	6.875	.438	0587 3714	SPLIT	NBR
5.875	6.875	.438	0587 3714 V	SPLIT	FKM
5.875	6.875	.500	6617 H1L5	RUP	NBR
5.875	6.875	.500	6617 H1L5 PTFE	RUP	N/P
5.875	6.875	.500	6617 H5L16	RUP	FKM
5.875	6.875	.500	0587 12737	SPLIT	NBR
5.875	6.875	.500	0587 12737 V	SPLIT	FKM
5.875	6.875	.500	TMAL 6875-3232	TMAL	PTFE
5.875	7.000	.438	12092 414	DS	CR
5.875	7.000	.563	0587 4337	SPLIT	NBR
5.875	7.000	.563	0587 4337 V	SPLIT	FKM
5.875	7.000	.563	0587 4337 V	SPLIT	NBR
5.875	7.000	.625	12021 H1L5	LPD	NBR
5.875	7.000	.625	12021 H5L16	LPD	FKM
5.875	7.000	.625	TMAL 7000-4036	TMAL	PTFE
5.875	7.125	.469	0587 18277	SPLIT	NBR
5.875	7.125	.500	20766 H1L5	LUP	NBR
5.875	7.125	.625	15705 H1L5	B	NBR
5.875	7.125	.625	9654 H1L5	LUP	NBR
5.875	7.125	.625	9654 H5L16	LUP	FKM
5.875	7.125	.625	8474 H1L5	OLR	NBR
5.875	7.125	.625	0587 7179	SPLIT	NBR
5.875	7.125	.625	0587 7179 V	SPLIT	FKM
5.875	7.188	.625	18833 H1L5	OLR	NBR
5.875	7.375	.625	10438 H1L5	LPD	NBR
5.875	7.375	.625	10438 H5L16	LPD	FKM
5.875	7.375	.625	0587 4711 V	SPLIT	FKM
5.875	7.375	.750	0587 9824	SPLIT	NBR
5.875	7.438	.750	14255 H1L5	RPD	NBR
5.875	7.500	.500	TMAL 7500-3252	TMAL	PTFE
5.875	7.500	.562	20437 H1L5	LUPW	NBR
5.875	7.500	.563	13816 H1L5	LPD	NBR
5.875	7.500	.625	0587 17271	SPLIT	NBR
5.903	7.125	.625	14968 H1L5	RPD	NBR
5.903	7.125	.625	14968 H5L16	RPD	FKM
5.905	7.086	.512	20647 5066	HP	FKM

See Section 4 for seal type description. For High Misalignment sizes, see Page B-86. For FlexiSeal Listings, see Pages B-93 and B-97.

03/03/06



Rotary Lip Seal Inch Sizes

5.906 to 6.000

B

Shaft Dia.	Bore Dia.	Seal Width	Parker Part Number	Seal Type	Material
5.906	6.875	.500	13105 H1L7	H	NBR
5.906	7.087	.591	18745 H1L5	RUP	NBR
5.906	7.087	.591	18745 H5L16	RUP	FKM
5.906	7.480	.591	15172 H1L5	RPD	NBR
5.906	7.480	.591	15172 H5L16	RPD	FKM
5.906	7.874	.591	30195 H1L5	LUP	NBR
5.906	8.268	.591	18379 H1L5	LUP	NBR
5.907	6.907	.500	0590 12737	SPLIT	NBR
5.907	7.102	.734	0590 17740	SPLIT	NBR
5.907	7.155	.625	0590 7179	SPLIT	NBR
5.907	7.407	.625	0590 15951	SPLIT	NBR
5.907	7.407	.750	0590 9824	SPLIT	NBR
5.930	7.055	.625	0593 5350	SPLIT	NBR
5.930	7.734	.490	14730 ALLL5	DS	NBR
5.936	6.936	.500	17229 H1L5	LUP	NBR
5.938	6.800	.479	18812 ALLL5	SS	NBR
5.938	6.938	.438	19161 H1L5	LUP	NBR
5.938	6.938	.438	19161 H5L16	LUP	FKM
5.938	6.938	.438	0593 9795	SPLIT	NBR
5.938	6.938	.500	0593 12737	SPLIT	NBR
5.938	6.938	.500	0593 12737 V	SPLIT	FKM
5.938	7.000	.500	0593 13475	SPLIT	NBR
5.938	7.000	.500	0593 13475 V	SPLIT	FKM
5.938	7.000	.563	10258 H1L5	LPD	NBR
5.938	7.000	.563	10258 H5L16	LPD	FKM
5.938	7.000	.563	10258 H5MX5489	LPD	FKM
5.938	7.000	.563	10263 H1L5	LPDW	NBR
5.938	7.000	.563	10263 H1L5 PTFE	LPDW	N/P
5.938	7.000	.563	10263 H5L16	LPDW	FKM
5.938	7.000	.563	19193 H1L5	LPDW	NBR
5.938	7.000	.563	19193 H5L16	LPDW	FKM
5.938	7.188	.625	18182 H1L5	RUP	NBR
5.938	7.188	.625	18182 H5L16	RUP	FKM
5.938	7.188	.625	0593 4548	SPLIT	NBR
5.938	7.188	.625	0593 4548 V	SPLIT	FKM
5.938	7.188	.625	0593 7179	SPLIT	NBR
5.938	7.188	.625	0593 7179 V	SPLIT	FKM
5.938	7.250	.625	0593 4241	SPLIT	NBR
5.938	7.438	.625	0593 15951	SPLIT	NBR
5.938	7.438	.625	0593 15951 V	SPLIT	FKM
5.938	7.438	.750	0593 9103	SPLIT	NBR
5.938	7.438	.750	0593 9824	SPLIT	NBR
5.938	7.500	.563	9351 H1L5	LPD	NBR
5.938	7.500	.563	9351 H5L16	LPD	FKM
5.938	7.500	.563	6702 H1L5	RUP	NBR
5.938	7.500	.563	6702 H1L5 PTFE	RUP	N/P
5.938	7.500	.563	6702 H5L16	RUP	FKM
5.938	7.500	.563	0593 9455	SPLIT	NBR
5.938	7.500	.750	9401 H1L5	LPD	NBR
5.938	7.500	.750	9401 H1L5 PTFE	LPD	N/P
5.938	7.500	.750	9401 H5L16	LPD	FKM
5.950	6.950	.438	0595 9795	SPLIT	NBR
5.969	6.969	.438	0596 9795	SPLIT	NBR
5.969	7.469	.625	0596 15951	SPLIT	NBR
5.980	7.480	.750	0598 9824	SPLIT	NBR
5.993	7.493	.625	0599 15951	SPLIT	NBR
5.993	7.493	.625	0599 15951 V	SPLIT	FKM
6.000	.750	.750	19890 H5L16	LUP	FKM
6.000	6.750	.500	10981 H1L7	P	NBR
6.000	6.750	.500	13948 ALLL16	P	FKM
6.000	6.750	.500	13948 ALLL7	P	NBR
6.000	6.750	.500	0600 20522	SPLIT	NBR
6.000	7.000	.438	16079 H1L5	LDS	NBR
6.000	7.000	.438	9514 H1L5	LUP	NBR
6.000	7.000	.438	9514 H1L5 PTFE	LUP	N/P
6.000	7.000	.438	9514 H1L7	LUP	NBR

Shaft Dia.	Bore Dia.	Seal Width	Parker Part Number	Seal Type	Material
6.000	7.000	.438	9514 H1L70	LUP	NBR
6.000	7.000	.438	9514 H5L16	LUP	FKM
6.000	7.000	.438	9514 H5L16 PTFE	LUP	F/P
6.000	7.000	.438	17956 H1L5	LUPW	NBR
6.000	7.000	.438	17956 H5L16	LUPW	FKM
6.000	7.000	.438	17861 H1L5	LUPW	NBR
6.000	7.000	.438	17861 H5L16	LUPW	FKM
6.000	7.000	.438	3714 H1L21	RPD	EPDM
6.000	7.000	.438	3714 H1L5	RPD	NBR
6.000	7.000	.438	3714 H1L5 PTFE	RPD	N/P
6.000	7.000	.438	3714 H5L16	RPD	FKM
6.000	7.000	.438	3714 H5L16 PTFE	RPD	F/P
6.000	7.000	.438	0600 19540 V	SPLIT	FKM
6.000	7.000	.438	0600 9795	SPLIT	NBR
6.000	7.000	.438	0600 9795 V	SPLIT	FKM
6.000	7.000	.438	0600 3863	SPLIT	NBR
6.000	7.000	.438	TMAL 7000-2832	TMAL	PTFE
6.000	7.000	.500	0600 12737	SPLIT	NBR
6.000	7.000	.500	0600 12737 L21	SPLIT	EPDM
6.000	7.000	.625	15803 H1L5	STLDS	NBR
6.000	7.000	.750	2499 H1L5	LUP	NBR
6.000	7.000	.750	2499 H5MX5489	LPD	FKM
6.000	7.000	.813	15256 H1L7	P	NBR
6.000	7.063	.500	0600 13475	SPLIT	NBR
6.000	7.087	.500	10947 H1L5	OLRUP	NBR
6.000	7.125	.563	4337 H1L5	RPD	NBR
6.000	7.125	.563	4337 H5L16	RPD	FKM
6.000	7.125	.625	12196 H1L5	LUP	NBR
6.000	7.125	.625	0600 5350	SPLIT	NBR
6.000	7.125	.625	0600 5350 V	SPLIT	FKM
6.000	7.203	.734	0600 17740	SPLIT	NBR
6.000	7.250	.469	8940 H1L5	LPD	NBR
6.000	7.250	.469	8940 H5MX5489	LPD	FKM
6.000	7.250	.469	0600 18277	SPLIT	NBR
6.000	7.250	.500	19081 5066	HP	FKM
6.000	7.250	.500	8511 H1L5	LUP	NBR
6.000	7.250	.500	8511 H5L16	LUP	FKM
6.000	7.250	.625	0600 4548	SPLIT	NBR
6.000	7.250	.625	0600 7179	SPLIT	NBR
6.000	7.250	.625	0600 7179 V	SPLIT	FKM
6.000	7.375	.438	10718 414	DS	CR
6.000	7.375	.500	13759 H1L5	LPD	NBR
6.000	7.375	.500	13759 H5L16	LPD	FKM
6.000	7.375	.500	0600 14697	SPLIT	NBR
6.000	7.375	.500	0600 14697 V	SPLIT	FKM
6.000	7.375	.750	14531 H1L5	LDS	NBR
6.000	7.375	.750	14531 H5L16	LDS	FKM
6.000	7.375	.750	14531 H5MX5489	LDS	FKM
6.000	7.500	.250	13440 H1L7	SS	NBR
6.000	7.500	.375	3711 H1L5	LPD	NBR
6.000	7.500	.500	0600 9718	SPLIT	NBR
6.000	7.500	.562	19591 H1L5	LUP	NBR
6.000	7.500	.562	19591 H5MX5489	LUP	FKM
6.000	7.500	.562	8947 H1L5	LUP	NBR
6.000	7.500	.625	4711 H1L5	RUP	NBR
6.000	7.500	.625	4711 H5L16	RUP	FKM
6.000	7.500	.625	0600 15951	SPLIT	NBR
6.000	7.500	.625	0600 15951 V	SPLIT	FKM
6.000	7.500	.675	16177 H1L5	SPC	NBR
6.000	7.500	.675	17300 H1L5	LUPW	NBR
6.000	7.500	.675	17300 H5L16	LUPW	FKM
6.000	7.500	.750	11077 H1L5	LPDW	NBR
6.000	7.500	.750	9993 H1L5	LUP	NBR
6.000	7.500	.750	0600 8901	SPLIT	NBR
6.000	7.500	.750	0600 9103	SPLIT	NBR
6.000	7.500	.750	0600 9435	SPLIT	NBR

See Section 4 for seal type description. For High Misalignment sizes, see Page B-86. For FlexiSeal Listings, see Pages B-93 and B-97.

03/03/06



B

Shaft Dia.	Bore Dia.	Seal Width	Parker Part Number	Seal Type	Material
6.000	7.500	.750	0600 9824	SPLIT	NBR
6.000	7.500	.750	0600 9824 V	SPLIT	FKM
6.000	7.506	.750	6719 H1L5	LA	NBR
6.000	7.508	.625	5610 H1L5	LUP	NBR
6.000	7.508	.625	5610 H1L5 PTFE	LUP	N/P
6.000	7.508	.625	5610 H1L50	LUP	NBR
6.000	7.508	.625	5610 H1L70	LUP	NBR
6.000	7.563	.563	0600 9455	SPLIT	NBR
6.000	7.625	.625	0600 17271	SPLIT	NBR
6.000	7.625	1.000	15160 H1L5	LUPW	NBR
6.000	7.750	.563	5979 H1L5	LA	NBR
6.000	8.375	.825	6445 H1L5	LPDW	NBR
6.005	7.000	.750	6111 H3L8	OLSS	CR
6.032	7.282	.625	0603 4548	SPLIT	NBR
6.032	7.532	.750	0603 9435	SPLIT	NBR
6.063	7.062	.500	0606 4345	SPLIT	NBR
6.063	7.063	.438	0606 9795	SPLIT	NBR
6.063	7.125	.500	0606 13475	SPLIT	NBR
6.063	7.125	.500	7141 H1L5	LUP	NBR
6.063	7.125	.500	7141 H5L16	LUP	FKM
6.063	7.125	.500	80002 H1L5	MIST	NBR
6.063	7.313	.625	0606 4548	SPLIT	NBR
6.063	7.375	.625	0606 4241	SPLIT	NBR
6.063	7.560	.500	9718 ALLL5	RPDT	NBR
6.063	7.563	.750	0606 9435	SPLIT	NBR
6.063	10.063	1.000	13145 ALLL5	RPD	NBR
6.102	7.086	.590	30084 H1L5	LUP	NBR
6.109	7.188	.375	70010 H1L5	TSS	NBR
6.120	7.125	.500	19391 H1L5	LPD	NBR
6.125	7.063	.500	15480 H1L5	LPD	NBR
6.125	7.125	.438	0612 9795	SPLIT	NBR
6.125	7.125	.438	0612 3863	SPLIT	NBR
6.125	7.125	.500	10311 H1L5	LUP	NBR
6.125	7.125	.500	10311 H5L16	LUP	FKM
6.125	7.125	.500	12737 H1L21	RPD	EPDM
6.125	7.125	.500	12737 H1L5	RPD	NBR
6.125	7.125	.500	12737 H5L16	RPD	FKM
6.125	7.125	.500	0612 11974	SPLIT	NBR
6.125	7.125	.500	0612 11974 V	SPLIT	FKM
6.125	7.125	.500	0612 4345	SPLIT	NBR
6.125	7.125	.625	10381 H1L5	LPD	NBR
6.125	7.125	.625	10381 H1L5 PTFE	LPD	N/P
6.125	7.125	.625	10381 H5L16	LPD	FKM
6.125	7.125	.625	18470 H1L5	LUP	NBR
6.125	7.125	.625	0612 10747	SPLIT	NBR
6.125	7.125	.625	TMAL 7125-4032	TMAL	PTFE
6.125	7.327	.734	0612 17740	SPLIT	NBR
6.125	7.375	.625	10153 H1L5	LPD	NBR
6.125	7.375	.625	7179 H1L5	RPD	NBR
6.125	7.375	.625	7179 H5L16	RPD	FKM
6.125	7.375	.625	0612 4548	SPLIT	NBR
6.125	7.500	.500	0612 14697	SPLIT	NBR
6.125	7.500	.500	11061 H1L5	LPD	NBR
6.125	7.625	.625	15951 H1L5	RUP	NBR
6.125	7.625	.625	15951 H5L16	RUP	FKM
6.125	7.625	.688	0612 5679	SPLIT	NBR
6.125	7.625	.750	9824 H1L5	RUP	NBR
6.125	7.625	.750	9824 H5L16	RUP	FKM
6.125	7.625	.750	0612 4472	SPLIT	NBR
6.125	7.625	.750	0612 8901	SPLIT	NBR
6.125	7.625	.750	0612 9103	SPLIT	NBR
6.125	7.625	.750	0612 9435	SPLIT	NBR
6.125	7.688	.563	9455 H1L5	RPD	NBR
6.125	7.750	.625	17271 H1L5	RUP	NBR
6.125	8.125	.500	12503 H1L5	RPD	NBR
6.130	7.505	.500	0613 14697	SPLIT	NBR

Shaft Dia.	Bore Dia.	Seal Width	Parker Part Number	Seal Type	Material
6.149	7.149	.500	14502 H1L7	H	NBR
6.180	7.252	.735	19590 H1L5	LDS	NBR
6.188	7.188	.438	0618 3863	SPLIT	NBR
6.188	7.188	.500	0618 11974	SPLIT	NBR
6.188	7.188	.500	0618 11974 V	SPLIT	FKM
6.188	7.188	.625	0618 10747	SPLIT	NBR
6.188	7.250	.500	13475 H1L5	RPD	NBR
6.188	7.250	.500	13475 H5L16	RPD	FKM
6.188	7.250	.500	13475 H5MX5489	RPD	FKM
6.188	7.250	.500	0618 16353	SPLIT	NBR
6.188	7.437	.625	0618 4548	SPLIT	NBR
6.188	7.500	.625	4864 H1L5	LUP	NBR
6.188	7.500	.625	4864 H1L5 PTFE	LUP	N/P
6.188	7.500	.625	4864 H5MX5489	LUP	FKM
6.188	7.500	.625	4241 H1L5	R	NBR
6.188	7.563	.500	0618 14697	SPLIT	NBR
6.188	7.688	.750	0618 9435	SPLIT	NBR
6.188	7.688	.750	9103 H1L5	R	NBR
6.219	7.469	.625	0621 4548	SPLIT	NBR
6.219	7.719	.688	0621 5679	SPLIT	NBR
6.235	7.820	.615	13746 H1L7	MISC	NBR
6.245	8.800	.563	18030 H1L5	SSW	NBR
6.245	8.800	.563	18030 H1L70	SSW	NBR
6.250	7.000	.410	15081 H1L7	P	NBR
6.250	7.000	.410	15081 H5L16	P	FKM
6.250	7.000	.500	20522 H1L5	RUP	NBR
6.250	7.063	.500	15835 H1L5	LUP	NBR
6.250	7.250	.438	10439 H1L21	LUP	EPDM
6.250	7.250	.438	10439 H1L5	LUP	NBR
6.250	7.250	.438	10439 H1L5 PTFE	LUP	N/P
6.250	7.250	.438	10439 H5L16	LUP	FKM
6.250	7.250	.438	19540 H5L16	RUP	FKM
6.250	7.250	.438	9795 H1L5	RUP	NBR
6.250	7.250	.438	9795 H1L7	RUP	NBR
6.250	7.250	.438	0625 3863	SPLIT	NBR
6.250	7.250	.438	TMAL 7250-2832	TMAL	PTFE
6.250	7.250	.500	0625 11974	SPLIT	NBR
6.250	7.250	.500	0625 4345	SPLIT	NBR
6.250	7.250	.500	16191 H1L5	STLUP	NBR
6.250	7.250	.625	0625 10747	SPLIT	NBR
6.250	7.375	.625	0625 5350	SPLIT	NBR
6.250	7.452	.734	17740 H1L5	RUP	NBR
6.250	7.500	.469	18277 H1L5	RUP	NBR
6.250	7.500	.500	19635 H5/MX5489	LUP	FKM
6.250	7.500	.500	8804 H1L5	LUP	NBR
6.250	7.500	.500	TMAL 7500-3240	TMAL	PTFE
6.250	7.500	.500	TMAL7500-3240HA	TMAL	PTFE
6.250	7.500	.562	17839 H1L5	LDS	NBR
6.250	7.500	.562	17839 H5L16	LDS	FKM
6.250	7.500	.625	16344 5066	HP	FKM
6.250	7.500	.625	16344 5066 304	HP	FKM
6.250	7.500	.625	16344 5066 316	HP	FKM
6.250	7.500	.625	7194 H1L5	LPD	NBR
6.250	7.500	.625	7194 H5L16	LPD	FKM
6.250	7.500	.625	0625 14037	SPLIT	NBR
6.250	7.500	.625	0625 4548	SPLIT	NBR
6.250	7.500	.625	0625 4548 V	SPLIT	FKM
6.250	7.625	.500	0625 14697	SPLIT	NBR
6.250	7.750	.625	3933 H1L5	B	NBR
6.250	7.750	.688	0625 5679	SPLIT	NBR
6.250	7.750	.750	19638 H5L16	LUP	FKM
6.250	7.750	.750	8949 H1L5	LUP	NBR
6.250	7.750	.750	8949 H5L16	LUP	FKM
6.250	7.750	.750	8901 H1L5	R	NBR
6.250	7.750	.750	0625 9435	SPLIT	NBR
6.250	8.000	.750	15750 H1L5	LDS	NBR

See Section 4 for seal type description. For High Misalignment sizes, see Page B-86. For FlexiSeal Listings, see Pages B-93 and B-97.

03/03/06



Rotary Lip Seal Inch Sizes

6.250 to 6.500

B

Shaft Dia.	Bore Dia.	Seal Width	Parker Part Number	Seal Type	Material
6.250	8.125	.625	0625 16413 V	SPLIT	FKM
6.250	8.250	1.000	0625 11426	SPLIT	NBR
6.250	9.000	1.448	9463 H1L5	LPD	NBR
6.282	7.282	.500	0628 11974	SPLIT	NBR
6.282	7.532	.625	0628 14037	SPLIT	NBR
6.299	6.891	.472	15220 H1L5	P	NBR
6.299	7.480	.591	18671 H1L20	LUP	XNBR
6.299	7.480	.591	18671 H1L5	LUP	NBR
6.299	7.480	.591	18671 H5L16	LUP	FKM
6.299	7.480	.591	0629 19123	SPLIT	NBR
6.313	7.312	.500	0631 11974	SPLIT	NBR
6.313	7.313	.625	0631 10747	SPLIT	NBR
6.313	7.375	.500	16353 H1L5	RUP	NBR
6.313	7.563	.625	0631 14037	SPLIT	NBR
6.333	7.250	.500	8976 H1L5	LPD	NBR
6.344	7.344	.500	0634 11974	SPLIT	NBR
6.344	7.469	.625	0634 5350	SPLIT	NBR
6.375	7.375	.438	9749 H1L5	LPD	NBR
6.375	7.375	.438	9749 H1L5 PTFE	LPD	N/P
6.375	7.375	.438	9749 H1L7	LPD	NBR
6.375	7.375	.438	9749 H5L16	LPD	FKM
6.375	7.375	.438	0637 3863	SPLIT	NBR
6.375	7.375	.438	0637 3863 V	SPLIT	FKM
6.375	7.375	.438	0637 4385	SPLIT	NBR
6.375	7.375	.500	4345 H1L5	RPD	NBR
6.375	7.375	.500	4345 H5L16	RPD	FKM
6.375	7.375	.500	0637 11974	SPLIT	NBR
6.375	7.375	.500	0637 11974 V	SPLIT	FKM
6.375	7.375	.625	16214 H1L5	LUPW	NBR
6.375	7.375	.625	16214 H5L16	LUPW	FKM
6.375	7.375	.625	0637 10747	SPLIT	NBR
6.375	7.430	.563	17106 H1L5	LUP	NBR
6.375	7.500	.500	60008 H1L5	LDS	NBR
6.375	7.500	.500	60008 H5L16	LDS	FKM
6.375	7.500	.500	9192 H1L5	LUP	NBR
6.375	7.500	.500	9192 H1L5 PTFE	LUP	N/P
6.375	7.500	.500	9192 H5L16	LUP	FKM
6.375	7.500	.625	0637 5350	SPLIT	NBR
6.375	7.500	.625	0637 5350 PTFE	SPLIT	N/P
6.375	7.625	.625	0637 14037	SPLIT	NBR
6.375	7.625	.625	0637 14037 V	SPLIT	FKM
6.375	7.625	.625	4548 H1L5	RUP	NBR
6.375	7.625	.625	4548 H5L16	RUP	FKM
6.375	7.625	.625	0637 6700	SPLIT	NBR
6.375	7.625	.625	0637 6700 V	SPLIT	FKM
6.375	7.750	.500	16828 H1L5	LUPW	NBR
6.375	7.750	.500	0637 14697	SPLIT	NBR
6.375	7.750	.500	0637 14697 V	SPLIT	FKM
6.375	7.875	.625	6916 H1L5	LPD	NBR
6.375	7.875	.625	6916 H5L16	LPD	FKM
6.375	7.875	.625	17886 H1L5	LUP	NBR
6.375	7.875	.625	17886 H1L70	LUP	NBR
6.375	7.875	.688	0637 19541 V	SPLIT	FKM
6.375	7.875	.688	0637 5679	SPLIT	NBR
6.375	7.875	.750	0637 4472	SPLIT	NBR
6.375	7.875	.750	0637 9209	SPLIT	NBR
6.375	7.875	.750	0637 9209 V	SPLIT	FKM
6.375	7.875	.750	9435 H1L5	RUP	NBR
6.375	8.000	.912	19982 H1L5	LUPW	NBR
6.375	8.125	.750	0637 3923	SPLIT	NBR
6.407	7.407	.500	0640 11974	SPLIT	NBR
6.407	7.657	.625	0640 6700	SPLIT	NBR
6.438	6.969	.438	12147 H1L7	P	NBR
6.438	7.408	.625	0643 10747	SPLIT	NBR
6.438	7.438	.500	0643 11974	SPLIT	NBR
6.438	7.438	.500	0643 11974 V	SPLIT	FKM

Shaft Dia.	Bore Dia.	Seal Width	Parker Part Number	Seal Type	Material
6.438	7.563	.625	0643 5350	SPLIT	NBR
6.438	7.688	.625	0643 6700	SPLIT	NBR
6.438	7.688	.625	0643 6700 V	SPLIT	FKM
6.438	7.750	.750	11334 H1L5	LUP	NBR
6.438	7.750	.750	11334 H1L5 PTFE	LUP	N/P
6.438	7.750	.750	11334 H5L16	LUP	FKM
6.438	7.938	.750	0643 9209	SPLIT	NBR
6.450	7.700	.625	0645 6700	SPLIT	NBR
6.469	7.469	.500	0646 11974	SPLIT	NBR
6.469	7.469	.625	0646 10747	SPLIT	NBR
6.469	7.719	.625	0646 6700	SPLIT	NBR
6.473	7.473	.500	0647 11974	SPLIT	NBR
6.490	7.500	.500	17900 H1L5	OLLUP	NBR
6.496	7.480	.465	20780 5202	MP	FKM
6.500	7.250	.410	11986 H1L7	P	NBR
6.500	7.250	.410	11986 H5L16	P	FKM
6.500	7.280	.479	18724 ALLL5	SS	NBR
6.500	7.500	.438	3863 H1L5	RPD	NBR
6.500	7.500	.438	3863 H5L16	RPD	FKM
6.500	7.500	.500	16892 H1L30	OLLUP	HNBR
6.500	7.500	.500	16892 H1L5	OLLUP	NBR
6.500	7.500	.500	16892 H5L16	OLLUP	FKM
6.500	7.500	.500	0650 11974	SPLIT	NBR
6.500	7.500	.500	0650 11974 V	SPLIT	FKM
6.500	7.500	.562	19637 H5/MX5489	LUP	FKM
6.500	7.500	.563	10267 H1L3	LUP	CR
6.500	7.500	.563	10267 H1L5	LUP	NBR
6.500	7.500	.563	10267 H5/MX5489	LUP	FKM
6.500	7.500	.563	10267 H5L16	LUP	FKM
6.500	7.500	.594	11918 H1L7	P	NBR
6.500	7.500	.625	12772 H1L5	LPD	NBR
6.500	7.500	.625	12772 H5L16	LPD	FKM
6.500	7.500	.625	0650 10747	SPLIT	NBR
6.500	7.500	.625	0650 10747 V	SPLIT	FKM
6.500	7.500	.750	TMAL 7500-4832	TMAL	PTFE
6.500	7.625	.625	0650 5350	SPLIT	NBR
6.500	7.625	.625	0650 5350 V	SPLIT	FKM
6.500	7.702	.500	19347 H1L5	LUP-OL	NBR
6.500	7.750	.625	10715 H1L5	LPD	NBR
6.500	7.750	.625	10715 H5L16	LPD	FKM
6.500	7.750	.625	10715 H1L20	LUP	XNBR
6.500	7.750	.625	14037 H1L5	RPD	NBR
6.500	7.750	.625	14037 H5L16	RPD	FKM
6.500	7.750	.625	0650 6700	SPLIT	NBR
6.500	7.750	.625	0650 6700 PTFE	SPLIT	N/P
6.500	7.750	.625	0650 6700 V	SPLIT	FKM
6.500	7.750	.625	TMAL 7750-4040	TMAL	PTFE
6.500	7.875	.500	14697 H1L5	RPD	NBR
6.500	7.875	.500	14697 H5L16	RPD	FKM
6.500	7.875	.625	0650 3991	SPLIT	NBR
6.500	7.875	.625	0650 3991 V	SPLIT	FKM
6.500	8.000	.625	0650 4103	SPLIT	NBR
6.500	8.000	.625	3698 H1L5	B	NBR
6.500	8.000	.688	0650 5679	SPLIT	NBR
6.500	8.000	.750	16762 H1L5	LDS	NBR
6.500	8.000	.750	16762 H5/MX5489	LDS	FKM
6.500	8.000	.750	8950 H1L5	LUP	NBR
6.500	8.000	.750	8950 H5L16	LUP	FKM
6.500	8.000	.750	0650 4472	SPLIT	NBR
6.500	8.000	.750	0650 9209	SPLIT	NBR
6.500	8.250	.750	0650 10461	SPLIT	NBR
6.500	8.336	.500	18430 H1L5	LUPW	NBR
6.500	8.336	.500	18430 H1L5 (special)	LUPW	NBR
6.500	8.336	.500	18430 H5L16	LUPW	FKM
6.500	8.336	.500	18430 H5L16 (Special)+E203	LUPW	FKM
6.500	8.375	1.000	0650 18498	SPLIT	NBR

See Section 4 for seal type description. For High Misalignment sizes, see Page B-86. For FlexiSeal Listings, see Pages B-93 and B-97.

03/03/06



B

Shaft Dia.	Bore Dia.	Seal Width	Parker Part Number	Seal Type	Material
6.500	8.500	1.000	0650 11426	SPLIT	NBR
6.500	8.528	.535	9137 H1L21	SSW	EPDM
6.500	8.528	.535	9137 H1L5	SSW	NBR
6.560	7.810	.625	0656 4254	SPLIT	NBR
6.563	7.688	.625	0656 5350	SPLIT	NBR
6.563	7.938	.625	0656 3991	SPLIT	NBR
6.563	8.063	.500	0656 10476	SPLIT	NBR
6.594	7.719	.625	0659 5350	SPLIT	NBR
6.625	7.625	.438	0662 4385	SPLIT	NBR
6.625	7.625	.500	11974 H1L5	RUP	NBR
6.625	7.625	.500	11974 H5L16	RUP	FKM
6.625	7.625	.625	10951 H1L5	LPD	NBR
6.625	7.625	.625	10951 H5L16	LPD	FKM
6.625	7.625	.625	10747 H1L5	RPD	NBR
6.625	7.625	.625	10747 H5L16	RPD	FKM
6.625	7.750	.625	0662 5350	SPLIT	NBR
6.625	7.875	.625	0662 4254	SPLIT	NBR
6.625	7.875	.625	6700 H1L5	RPD	NBR
6.625	7.875	.625	6700 H1L5 PTFE	RPD	N/P
6.625	7.875	.625	6700 H5L16	RPD	FKM
6.625	8.000	.625	0662 3991	SPLIT	NBR
6.625	8.000	.750	9972 H1L2160	LUP	EPDM
6.625	8.000	.750	9972 H1L5	LUP	NBR
6.625	8.000	.750	9972 H5L16	LUP	FKM
6.625	8.117	.500	0662 10472	SPLIT	NBR
6.625	8.125	.500	0662 10476	SPLIT	NBR
6.625	8.125	.500	0662 10476 V	SPLIT	FKM
6.625	8.125	.625	0625 16413 V	SPLIT	FKM
6.625	8.125	.625	0662 16413	SPLIT	NBR
6.625	8.125	.625	0662 16413 V	SPLIT	FKM
6.625	8.125	.688	19541 H5L16	RPD	FKM
6.625	8.125	.688	5679 H1L5	RPD	NBR
6.625	8.125	.750	8431 H1L5	LUP	NBR
6.625	8.125	.750	8431 H5L16	LUP	FKM
6.625	8.125	.750	4472 H1L5	RPD	NBR
6.625	8.125	.750	0662 9209	SPLIT	NBR
6.625	8.125	.750	0662 9209 V	SPLIT	FKM
6.625	8.375	.750	0662 10461	SPLIT	NBR
6.625	8.500	.625	11995 H1L5	LPD	NBR
6.625	10.500	.500	19368 H1L5	LUP	NBR
6.632	7.813	.591	20768 H1L5	RUP	NBR
6.637	8.637	.625	0663 9658	SPLIT	NBR
6.657	8.157	.625	0665 16413	SPLIT	NBR
6.688	8.063	.625	0668 3991	SPLIT	NBR
6.688	8.188	.500	0668 10476	SPLIT	NBR
6.688	8.188	.625	0668 16413	SPLIT	NBR
6.688	8.188	.625	0669 16413	SPLIT	NBR
6.688	8.188	.750	0668 9209	SPLIT	NBR
6.693	7.874	.590	30087 H1L5	LUP	NBR
6.693	7.874	.591	19767 H1L5	LUP	NBR
6.695	7.750	.500	13091 H1L5	H	NBR
6.710	8.710	.625	0670 9658	SPLIT	NBR
6.719	7.717	.438	0671 4385	SPLIT	NBR
6.719	8.085	.625	0671 3991	SPLIT	NBR
6.719	8.219	.625	0671 16413	SPLIT	NBR
6.740	7.740	.438	0674 4385	SPLIT	NBR
6.750	7.750	.438	0675 11342	SPLIT	NBR
6.750	7.750	.438	0675 4385	SPLIT	NBR
6.750	7.750	.438	0675 4385 V	SPLIT	FKM
6.750	7.750	.500	10041 H1L5	LPD	NBR
6.750	7.750	.500	10041 H5L16	LPD	FKM
6.750	7.750	.500	10041 H5MX5489	LPD	FKM
6.750	7.750	.750	16215 H1L5	LUPW	NBR
6.750	7.750	.750	16215 H5L16	LUPW	FKM
6.750	7.750	1.000	3812 H1L5	B	NBR
6.750	7.875	.625	5350 H1L5	RPD	NBR

Shaft Dia.	Bore Dia.	Seal Width	Parker Part Number	Seal Type	Material
6.750	7.875	.625	5350 H5L16	RPD	FKM
6.750	7.875	.625	5350 H5L16 PTFE	RPD	F/P
6.750	7.875	.625	0675 5350	SPLIT	NBR
6.750	8.000	.625	14821 H1L5	LDS	NBR
6.750	8.000	.625	14984 H1L5	LDS	NBR
6.750	8.000	.625	9048 H1L5	LUP	NBR
6.750	8.000	.625	9048 H5L16	LUP	FKM
6.750	8.000	.625	9048 H5L89 PTFE	LUP	F/P
6.750	8.000	.625	0675 5420	SPLIT	NBR
6.750	8.000	.625	0675 5420 V	SPLIT	FKM
6.750	8.000	.625	TMAL 8000-4040	TMAL	PTFE
6.750	8.000	.656	9290 H1L5	LPD	NBR
6.750	8.000	.750	7208 H1L5	LUP	NBR
6.750	8.125	.625	0675 3991	SPLIT	NBR
6.750	8.250	.500	0675 10472	SPLIT	NBR
6.750	8.250	.500	0675 10476	SPLIT	NBR
6.750	8.250	.625	12078 H1L5	LPD	NBR
6.750	8.250	.625	12078 H5L16	LPD	FKM
6.750	8.250	.625	18711 H5L16	LPD	FKM
6.750	8.250	.625	15459 H1L5	LPDW	NBR
6.750	8.250	.625	15459 H5L16	LPDW	FKM
6.750	8.250	.625	16600 H1L5	LPDW	NBR
6.750	8.250	.625	16600 H5L16	LUPW	FKM
6.750	8.250	.625	0675 16413	SPLIT	NBR
6.750	8.250	.625	0675 16413 V	SPLIT	NBR
6.750	8.250	.750	16763 H1L5	LDS	NBR
6.750	8.250	.750	10062 H1L5	LUP	NBR
6.750	8.250	.750	10062 H5L16	LUP	FKM
6.750	8.250	.750	0675 9209	SPLIT	NBR
6.750	8.250	1.031	16153 H1L5	LDS	NBR
6.750	8.375	.625	0675 4005	SPLIT	NBR
6.750	8.500	.625	20406 H1L5	LDS	NBR
6.750	8.500	.750	3923 H1L5	B	NBR
6.750	8.500	.750	0675 10461	SPLIT	NBR
6.750	8.625	1.000	18498 H1L5	RUP	NBR
6.750	8.750	.625	0675 9658	SPLIT	NBR
6.750	8.750	1.000	11426 H1L5	RPD	NBR
6.750	8.900	.535	9136 H1L5	SSW	NBR
6.750	8.900	.535	9136 H1L5 PTFE	SSW	N/P
6.750	8.900	.535	9136 ALLMX5489	SSW	FKM
6.750	8.900	.535	9136 H5MX5489	SSW	FKM
6.771	7.875	.156	12106 H1L7	SS	NBR
6.771	7.875	.375	70011 H1L5	TSS	NBR
6.782	7.780	.438	0678 4385	SPLIT	NBR
6.782	8.032	.625	0678 5420	SPLIT	NBR
6.799	7.980	.591	19123 H1L5	RUP	NBR
6.799	7.980	.591	19123 H5L16	RUP	FKM
6.800	7.800	.375	19679 H1L5	LUP	NBR
6.813	7.813	.438	0681 4385	SPLIT	NBR
6.813	8.063	.625	0681 5420	SPLIT	NBR
6.870	8.375	.750	4103 H1L5	B	NBR
6.875	7.875	.438	0687 4385	SPLIT	NBR
6.875	7.875	.438	0687 4385 V	SPLIT	FKM
6.875	7.875	.625	0687 4218	SPLIT	NBR
6.875	8.000	.625	10383 H1L5	LUP	NBR
6.875	8.000	.625	10383 H1L5 PTFE	LUP	N/P
6.875	8.000	.625	10383 H5L16	LUP	FKM
6.875	8.125	.625	0687 5420	SPLIT	NBR
6.875	8.125	.625	20756 H1L5	LUP	NBR
6.875	8.250	.625	0687 3991	SPLIT	NBR
6.875	8.250	.625	0687 3991 V	SPLIT	FKM
6.875	8.375	.500	19138 H1L5	LUP	NBR
6.875	8.375	.500	0687 10476	SPLIT	NBR
6.875	8.375	.625	0687 16413	SPLIT	NBR
6.875	8.375	.750	14128 H1L5	LDS	NBR
6.875	8.375	.750	9209 H1L5	RUP	NBR

See Section 4 for seal type description. For High Misalignment sizes, see Page B-86.
For FlexiSeal Listings, see Pages B-93 and B-97.

03/03/06



Rotary Lip Seal Inch Sizes

6.875 to 7.087

B

Shaft Dia.	Bore Dia.	Seal Width	Parker Part Number	Seal Type	Material
6.875	8.375	.750	9209 H5L16	RUP	FKM
6.875	8.375	.750	0687 13121	SPLIT	NBR
6.875	8.384	.625	0687 15453	SPLIT	NBR
6.875	8.384	.625	9931 H1L5	LUP	NBR
6.875	8.388	.375	17018 H1L5	LUPW	NBR
6.875	8.500	.625	0687 4005	SPLIT	NBR
6.875	8.625	.750	10461 H1L5	RPD	NBR
6.875	10.375	.469	13197 H1L5	LPD	NBR
6.890	7.874	.591	80175 H1L5	MIST	NBR
6.906	7.907	.625	0690 4218	SPLIT	NBR
6.906	8.282	.625	0690 13659	SPLIT	NBR
6.906	8.407	.625	0690 16413	SPLIT	NBR
6.906	8.532	.625	0690 4005	SPLIT	NBR
6.906	8.532	.625	0690 4005 V	SPLIT	FKM
6.910	8.785	.625	0691 9093	SPLIT	NBR
6.938	7.937	.438	0693 11342	SPLIT	NBR
6.938	7.938	.438	0693 4385	SPLIT	NBR
6.938	7.938	.438	0693 4385 V	SPLIT	FKM
6.938	7.938	.625	0693 4218	SPLIT	NBR
6.938	8.000	.625	9540 H1L5	LUP	NBR
6.938	8.000	.625	9540 H5L16	LUP	FKM
6.938	8.187	.625	0693 4254	SPLIT	NBR
6.938	8.188	.625	0693 5420	SPLIT	NBR
6.938	8.313	.625	0693 13659	SPLIT	NBR
6.938	8.437	.500	0693 10476	SPLIT	NBR
6.938	8.437	.750	0693 13121	SPLIT	NBR
6.938	8.438	.625	0693 16413	SPLIT	NBR
6.938	8.537	.625	0693 4005	SPLIT	NBR
6.938	8.935	.625	0693 9658	SPLIT	NBR
6.940	8.440	.625	0694 16413	SPLIT	NBR
6.963	8.463	.500	0696 9778	SPLIT	NBR
6.969	8.219	.625	0696 5420	SPLIT	NBR
6.969	8.344	.625	0696 13659	SPLIT	NBR
6.969	8.469	.625	0696 16413	SPLIT	NBR
6.969	8.585	.625	0696 4005	SPLIT	NBR
7.000	7.938	.500	16749 H1L5	LUPW	NBR
7.000	8.000	.437	3892 H1L5	LUP	NBR
7.000	8.000	.437	3892 H5L16	LUP	N/P
7.000	8.000	.437	3892 H5L16	LUP	FKM
7.000	8.000	.438	0700 11342	SPLIT	NBR
7.000	8.000	.438	0700 11342 V	SPLIT	FKM
7.000	8.000	.438	0700 3862	SPLIT	NBR
7.000	8.000	.438	0700 4385	SPLIT	NBR
7.000	8.000	.438	0700 4385 V	SPLIT	FKM
7.000	8.000	.500	13240 H1L5	LDS	NBR
7.000	8.000	.500	13240 H5L16	LDS	FKM
7.000	8.000	.500	TMAL 8000-3232	TMAL	PTFE
7.000	8.000	.620	19636 H5/MX5489	LUP	FKM
7.000	8.000	.625	13476 H1L3	LDSW	CR
7.000	8.000	.625	13476 H1L5	LDSW	NBR
7.000	8.000	.625	6862 H1L5	LPD	NBR
7.000	8.000	.625	10907 H1L5	LUPW	NBR
7.000	8.000	.625	10907 H5L16	LUPW	FKM
7.000	8.000	.625	19450 H1L20	LUPW	XNBR
7.000	8.000	.625	19450 H1L7	LUPW	NBR
7.000	8.000	.625	0700 12522 V	SPLIT	FKM
7.000	8.000	.625	0700 4218	SPLIT	NBR
7.000	8.000	.625	0700 4218 PTFE	SPLIT	NBR
7.000	8.000	.625	0700 4218 V	SPLIT	FKM
7.000	8.000	.750	10063 H1L5	LPD	NBR
7.000	8.000	.750	8955 H1L5	LPD	NBR
7.000	8.125	.625	10025 H1L5	LUP	NBR
7.000	8.125	.625	10025 H5L16	LUP	FKM
7.000	8.250	.625	17062 H1L5	LUP	NBR
7.000	8.250	.625	17062 H5L16	LUP	FKM
7.000	8.250	.625	0700 5420	SPLIT	NBR

Shaft Dia.	Bore Dia.	Seal Width	Parker Part Number	Seal Type	Material
7.000	8.250	.625	0700 5420 V	SPLIT	FKM
7.000	8.250	.750	6840 H1L5	LUP	NBR
7.000	8.250	.750	0700 11266	SPLIT	NBR
7.000	8.313	.750	0700 9713	SPLIT	NBR
7.000	8.250	.750	TMAL 8250-4840	TMAL	PTFE
7.000	8.250	.750	TMAS 8250-4840	TMAS	PTFE
7.000	8.375	.438	10721 414	DS	CR
7.000	8.375	.625	18220 H5L16	LPD	FKM
7.000	8.375	.625	3991 H1L5	RUP	NBR
7.000	8.375	.625	3991 H5L16	RUP	FKM
7.000	8.375	.625	0700 12997	SPLIT	NBR
7.000	8.375	.625	0700 13659	SPLIT	NBR
7.000	8.500	.500	17746 H1L5	LDS	NBR
7.000	8.500	.500	17746 H1L70	LDS	NBR
7.000	8.500	.500	19300 H1L5	LDS	NBR
7.000	8.500	.500	0700 10472	SPLIT	NBR
7.000	8.500	.500	0700 10476	SPLIT	NBR
7.000	8.500	.500	0700 9778	SPLIT	NBR
7.000	8.500	.600	0700 3589	SPLIT	NBR
7.000	8.500	.625	9304 H1L5	LUP	NBR
7.000	8.500	.625	9304 H1L70	LUP	NBR
7.000	8.500	.625	9304 H5L16	LUP	FKM
7.000	8.500	.625	0700 16413	SPLIT	NBR
7.000	8.500	.625	0700 16413 V	SPLIT	FKM
7.000	8.500	.750	11577 H1L5	LUP	NBR
7.000	8.500	.750	11577 H5L16	LUP	FKM
7.000	8.500	.750	0700 13121	SPLIT	NBR
7.000	8.500	.750	0700 13121 V	SPLIT	FKM
7.000	8.500	.750	0700 9420	SPLIT	NBR
7.000	8.507	.875	12774 H1L5	LDS	NBR
7.000	8.509	.625	15453 H1L5	RPD	NBR
7.000	8.625	.625	0700 4005	SPLIT	NBR
7.000	8.874	.625	0700 9093	SPLIT	NBR
7.000	9.000	.625	0700 9658	SPLIT	NBR
7.000	9.000	.625	0700 9658 V	SPLIT	FKM
7.000	11.000	1.000	13523 ALLL5	RPD	NBR
7.008	8.386	.468	19276 H5L16	LUPW	FKM
7.028	8.313	.406	70012 H1L5	TSS	NBR
7.032	8.407	.625	0703 13659	SPLIT	NBR
7.050	8.000	.500	18886 H1L5	SDS	NBR
7.063	8.000	.563	11082 H1L5	LUP	NBR
7.063	8.058	.438	3901 H1L5	LPD	NBR
7.063	8.063	.438	0706 4385	SPLIT	NBR
7.063	8.063	.438	0706 4385 V	SPLIT	FKM
7.063	8.313	.625	4254 H1L5	RUP	NBR
7.063	8.313	.625	4254 H5L16	RUP	FKM
7.063	8.313	.625	0706 5420	SPLIT	NBR
7.063	8.438	.625	0706 13659	SPLIT	NBR
7.063	8.560	.750	0706 13121	SPLIT	NBR
7.063	8.563	.500	10476 H1L5	RUP	NBR
7.063	8.563	.500	10476 H5MX5489	RUP	FKM
7.063	8.942	.625	0706 9093	SPLIT	NBR
7.070	8.015	.688	16523 ALLL5	DS	NBR
7.080	8.262	.591	0707 18744 V	SPLIT	FKM
7.081	8.262	.591	0708 18744 V	SPLIT	FKM
7.085	8.267	.591	0708 18744	SPLIT	NBR
7.086	8.086	.625	0708 4218	SPLIT	NBR
7.086	9.500	.505	19930 H1L5	SSW	NBR
7.087	7.677	.472	15588 H1L7	P	NBR
7.087	7.677	.472	15588 H1L7 PTFE	P	N/P
7.087	8.087	.438	0708 4385	SPLIT	NBR
7.087	8.268	.591	18440 H1L5	LUP	NBR
7.087	8.268	.591	18440 H1L5 PTFE	LUP	N/P
7.087	8.268	.591	18440 H5L16PTFE	LUP	F/P
7.087	8.268	.591	18440 H5L89	LUP	FKM
7.087	8.661	.591	15173 H1L5	RPD	NBR

See Section 4 for seal type description. For High Misalignment sizes, see Page B-86. For FlexiSeal Listings, see Pages B-93 and B-97.

03/03/06



B

Shaft Dia.	Bore Dia.	Seal Width	Parker Part Number	Seal Type	Material
7.087	8.661	.591	15173 H5L16	RPD	FKM
7.088	8.338	.625	0708 5420	SPLIT	NBR
7.094	8.094	.625	0709 4218	SPLIT	NBR
7.094	8.344	.625	0709 5420	SPLIT	NBR
7.094	8.469	.625	0709 13659	SPLIT	NBR
7.120	8.625	.750	4277 H1L5	B	NBR
7.125	8.000	.563	12325 H1L5	LPD	NBR
7.125	8.125	.438	0712 4385	SPLIT	NBR
7.125	8.125	.500	19403 H1L5	LUPW	NBR
7.125	8.125	.500	11714 H1L3	OLLPD	CR
7.125	8.125	.500	11714 H1L30	OLLPD	HNBR
7.125	8.125	.500	11714 H1L5	OLLPD	NBR
7.125	8.125	.625	0712 4218	SPLIT	NBR
7.125	8.250	.750	16213 H1L5	LUPW	NBR
7.125	8.250	.750	16213 H5L16	LUPW	FKM
7.125	8.375	.625	20755 H1L5	LUP	NBR
7.125	8.375	.625	0712 5420	SPLIT	NBR
7.125	8.375	.750	0712 11266	SPLIT	NBR
7.125	8.500	.625	10379 H1L5	LUP	NBR
7.125	8.500	.625	10379 H1L5 PTFE	LUP	N/P
7.125	8.500	.625	10379 H5L16	LUP	FKM
7.125	8.500	.625	12997 H1L5	RPD	NBR
7.125	8.625	.625	16413 H1L5	RUP	NBR
7.125	8.625	.625	16413 H5L16	RUP	FKM
7.125	8.500	.625	0712 13659	SPLIT	NBR
7.125	8.625	.750	12481 H1L5	LUP	NBR
7.125	8.625	.750	13121 H1L5	RPD	NBR
7.125	8.625	.750	13121 H5L16	RPD	FKM
7.125	8.625	.750	0712 15465	SPLIT	NBR
7.125	8.625	.750	0712 15465 V	SPLIT	FKM
7.125	8.625	.750	0712 9420	SPLIT	NBR
7.125	8.750	.625	12338 H1L5	LPD	NBR
7.125	8.750	.625	0712 4005	SPLIT	NBR
7.125	9.125	.625	9658 H1L5	RPD	NBR
7.125	9.125	.625	9658 H5L16	RPD	FKM
7.156	8.157	.438	0715 11342	SPLIT	NBR
7.156	8.407	.625	0715 8432	SPLIT	NBR
7.156	8.469	.750	0715 9713	SPLIT	NBR
7.188	8.185	.750	0718 9713	SPLIT	NBR
7.188	8.187	.625	0718 12522	SPLIT	NBR
7.188	8.188	.438	0718 11342	SPLIT	NBR
7.188	8.188	.625	0718 4218	SPLIT	NBR
7.188	8.438	.625	0718 8432	SPLIT	NBR
7.188	8.680	.500	10472 ALLL5	RPDT	NBR
7.188	8.688	.750	0718 15465	SPLIT	NBR
7.188	8.750	.750	0718 13756	SPLIT	NBR
7.188	9.063	.625	9093 H1L5	RUP	NBR
7.200	8.557	.575	19992 H1L5	SPEC	NBR
7.200	8.995	.500	18431 H1L5	LUPW	NBR
7.200	8.995	.500	18431 H1L5 (Special)	LUPW	NBR
7.205	8.583	.276	18910 H1L5	LUPW	NBR
7.219	8.218	.438	0721 11342	SPLIT	NBR
7.220	9.875	.963	19363 H1L5	LPD	NBR
7.220	9.875	.963	8881 H5L16	LPD	FKM
7.220	9.875	.963	8881 H1L5	LPDEL	NBR
7.240	8.560	.740	15044 ALLL7	SPCL	NBR
7.240	8.560	.740	15044 H1L7	SPCL	NBR
7.250	8.250	.438	12094 H1L5	LUP	NBR
7.250	8.250	.438	12094 H1L5 PTFE	LUP	N/P
7.250	8.250	.438	12094 H5L16	LUP	FKM
7.250	8.250	.438	4385 H1L5	RUP	NBR
7.250	8.250	.438	4385 H5L16	RUP	FKM
7.250	8.250	.438	0725 11342	SPLIT	NBR
7.250	8.250	.438	0725 11342 V	SPLIT	FKM
7.250	8.250	.438	0725 3862	SPLIT	NBR
7.250	8.250	.500	TMAL 8250-3232	TMAL	PTFE

Shaft Dia.	Bore Dia.	Seal Width	Parker Part Number	Seal Type	Material
7.250	8.250	.625	80092 H1L5	MIST	NBR
7.250	8.250	.625	0725 4218	SPLIT	NBR
7.250	8.250	.625	0725 4218 V	SPLIT	FKM
7.250	8.500	.500	TMAL 8500-3240	TMAL	PTFE
7.250	8.500	.625	10027 H1L5	LUP	NBR
7.250	8.500	.625	10027 H1L7	LUP	NBR
7.250	8.500	.625	10027 H5L16	LUP	FKM
7.250	8.500	.625	19419	MP	FKM
7.250	8.500	.625	5420 H1L5	RUP	NBR
7.250	8.500	.625	5420 H5L16	RUP	FKM
7.250	8.500	.625	0725 8432	SPLIT	NBR
7.250	8.500	.625	0725 8432 V	SPLIT	FKM
7.250	8.500	.750	0725 11266	SPLIT	NBR
7.250	8.500	.750	0725 9420	SPLIT	NBR
7.250	8.625	.625	13659 H1L5	RUP	NBR
7.250	8.625	.625	13659 H5L16	RUP	FKM
7.250	8.750	.375	19140 414	DS	CR
7.250	8.750	.750	18709 H5L16	LPD	FKM
7.250	8.750	.750	8951 H1L5	LUP	NBR
7.250	8.750	.750	8951 H5L16	LUP	FKM
7.250	8.750	.750	19358	MP	FKM
7.250	8.750	.750	0725 15465	SPLIT	NBR
7.250	8.750	.750	0725 15465 V	SPLIT	FKM
7.250	8.750	1.000	0725 5089	SPLIT	NBR
7.250	8.813	.750	0725 13756	SPLIT	NBR
7.250	8.875	.625	4005 H1L5	RPD	NBR
7.250	8.875	.625	4005 H5L16	RPD	FKM
7.250	9.500	1.436	18747 H1L5	LPDWEL	NBR
7.250	11.000	.469	12682 H1L5	LPD	NBR
7.269	8.269	.438	0727 3862	SPLIT	NBR
7.282	8.282	.625	0728 12522	SPLIT	NBR
7.283	7.875	.472	15126 H1L5	P	NBR
7.313	8.313	.625	0731 12522	SPLIT	NBR
7.313	8.438	.563	8990 H1L5	LUP	NBR
7.313	8.625	.750	9713 H1L5	RUP	NBR
7.355	8.605	.625	0735 8432	SPLIT	NBR
7.370	8.875	.625	3601 H1L5	LUP	NBR
7.375	8.375	.438	8926 H1L2160	LUP	EPDM
7.375	8.375	.438	8926 H1L3	LUP	CR
7.375	8.375	.438	8926 H1L5	LUP	NBR
7.375	8.375	.438	8926 H5L16	LUP	FKM
7.375	8.375	.438	11342 H1L5	RUP	NBR
7.375	8.375	.438	11342 H5L16	RUP	FKM
7.375	8.375	.438	0737 3862	SPLIT	NBR
7.375	8.375	.500	16647 H1L5	LDS	NBR
7.375	8.375	.500	16647 H5L16	LDS	FKM
7.375	8.375	.500	60016 H1L5	LDS	NBR
7.375	8.375	.500	11477 H1L5	OLLPD	NBR
7.375	8.375	.625	4218 H1L5	RUP	NBR
7.375	8.375	.625	4218 H1L5 PTFE	RUP	N/P
7.375	8.375	.625	4218 H5L16	RUP	FKM
7.375	8.375	.625	0737 12522	SPLIT	NBR
7.375	8.375	.625	0737 12522 V	SPLIT	FKM
7.375	8.500	.625	16219 ALLL16	LUP	FKM
7.375	8.500	.625	16219 H1L5	LUP	NBR
7.375	8.500	.625	16219 H5L16	LUP	FKM
7.375	8.625	.625	0737 8432	SPLIT	NBR
7.375	8.625	.750	11266 H1L5	RUP	NBR
7.375	8.625	.750	11266 H5L16	RUP	FKM
7.375	8.875	.750	0737 10787	SPLIT	NBR
7.375	8.875	.750	0737 10787 V	SPLIT	FKM
7.375	8.875	.750	0737 15465	SPLIT	NBR
7.375	8.875	.750	0737 9420	SPLIT	NBR
7.407	8.650	.625	0740 8432	SPLIT	NBR
7.428	9.039	.786	19573 H1L5	RUP	NBR
7.438	8.438	.438	0743 3862	SPLIT	NBR

See Section 4 for seal type description. For High Misalignment sizes, see Page B-86. For FlexiSeal Listings, see Pages B-93 and B-97.

03/03/06



Rotary Lip Seal Inch Sizes

7.438 to 7.750

B

Shaft Dia.	Bore Dia.	Seal Width	Parker Part Number	Seal Type	Material
7.438	8.438	.438	0743 3862 V	SPLIT	FKM
7.438	8.438	.625	0743 18236	SPLIT	NBR
7.438	8.688	.625	0743 8432	SPLIT	NBR
7.438	8.937	.750	0743 9420	SPLIT	NBR
7.438	8.938	.750	0743 15465	SPLIT	NBR
7.438	9.000	.750	0743 13756	SPLIT	NBR
7.438	9.875	.875	0743 12052	SPLIT	NBR
7.441	9.875	.512	18454 H1L5	LUP	NBR
7.469	8.469	.625	9962 H1L5	LPD	NBR
7.469	8.469	.625	9962 H5L16	LPD	FKM
7.469	8.719	.625	0746 8432	SPLIT	NBR
7.469	9.031	.750	0746 13756	SPLIT	NBR
7.480	8.662	.591	18744 H1L5	RUP	NBR
7.480	8.662	.591	18744 H5MX5489	RUP	FKM
7.480	8.980	.750	0748 15465	SPLIT	NBR
7.480	8.980	.750	0748 15465 V	SPLIT	FKM
7.480	9.055	.630	80065 H1L20	MIST	XNBR
7.480	9.055	.630	80065 H1L5	MIST	NBR
7.485	8.985	.750	0748 9420	SPLIT	NBR
7.500	8.500	.438	0750 10497	SPLIT	NBR
7.500	8.500	.438	0750 3862	SPLIT	NBR
7.500	8.500	.438	0750 3862 V	SPLIT	FKM
7.500	8.500	.500	11693 H1L5	LPD	NBR
7.500	8.500	.500	11693 H5L16	LPD	FKM
7.500	8.500	.500	9973 H1L5	LUP	NBR
7.500	8.500	.500	9973 H1L5 PTFE	LUP	N/P
7.500	8.500	.500	9973 H5L16	LUP	FKM
7.500	8.500	.594	13455 ALLL7	P	NBR
7.500	8.500	.625	0750 18236	SPLIT	NBR
7.500	8.500	.625	0750 18236 V	SPLIT	FKM
7.500	8.500	.625	15367 H1L5	LPD	NBR
7.500	8.500	.625	15367 H5L16	LPD	FKM
7.500	8.500	.625	19446 H5MX5489	LUPW	FKM
7.500	8.500	.625	12522 H1L5	RUP	NBR
7.500	8.500	.625	12522 H5L16	RUP	FKM
7.500	8.500	.625	12522 H5MX5489	RUP	FKM
7.500	8.625	.750	14155 H1L5	LPD	NBR
7.500	8.750	.625	8805 H1L20	LUP	XNBR
7.500	8.750	.625	8805 H1L5	LUP	NBR
7.500	8.750	.625	8805 H5L16	LUP	FKM
7.500	8.750	.625	0750 8432	SPLIT	NBR
7.500	8.750	.625	0750 8432 V	SPLIT	FKM
7.500	9.000	.500	0750 9778	SPLIT	NBR
7.500	9.000	.500	15015 H1L5	LPD	NBR
7.500	9.000	.500	15015 H5MX5489	LPD	FKM
7.500	9.000	.594	10099 H1L5	LPD	NBR
7.500	9.000	.594	10099 H5L16	LPD	FKM
7.500	9.000	.594	3589 H1L5	B	NBR
7.500	9.000	.625	0750 8847	SPLIT	NBR
7.500	9.000	.625	0750 8847 V	SPLIT	FKM
7.500	9.000	.750	19581 H1L5	LPDW	NBR
7.500	9.000	.750	19581 H5L16	LPDW	FKM
7.500	9.000	.750	19581 H5MX5489	LPDW	FKM
7.500	9.000	.750	10096 H1L20	LUP	XNBR
7.500	9.000	.750	10096 H1L5	LUP	NBR
7.500	9.000	.750	10096 H5MX5489	LUP	FKM
7.500	9.000	.750	0750 10787	SPLIT	NBR
7.500	9.000	.750	0750 15465	SPLIT	NBR
7.500	9.000	.750	0750 15465 V	SPLIT	FKM
7.500	9.000	.750	0750 9420	SPLIT	NBR
7.500	9.000	.750	0750 9420 V	SPLIT	FKM
7.500	9.000	1.000	0750 5089	SPLIT	NBR
7.500	9.250	.625	15745 H1L5	LUP	NBR
7.500	9.313	1.059	18554 H1L5	LUPW	NBR
7.500	9.313	1.059	18554 H5L16	LUPW	FKM
7.500	10.125	1.406	13810 H1L5	LDS	NBR

Shaft Dia.	Bore Dia.	Seal Width	Parker Part Number	Seal Type	Material
7.500	10.125	1.406	13810 H5L16	LDS	FKM
7.500	10.136	1.400	11803 H1L5	LPD	NBR
7.520	8.500	.438	12257 H1L5	RPD	NBR
7.531	9.032	.750	0753 9420	SPLIT	NBR
7.563	8.385	.343	0756 18802	SPLIT	NBR
7.563	8.813	.625	0756 4558	SPLIT	NBR
7.563	9.063	.625	0756 8847	SPLIT	NBR
7.563	9.063	.750	0756 10787	SPLIT	NBR
7.563	9.063	.750	0756 9420	SPLIT	NBR
7.580	9.080	.625	0758 8847	SPLIT	NBR
7.580	9.080	.750	0758 14282 V	SPLIT	FKM
7.595	9.250	.500	6101 H1L5	LPD	NBR
7.600	8.600	.438	0760 3862	SPLIT	NBR
7.625	8.625	.438	0762 10497	SPLIT	NBR
7.625	8.625	.438	0762 10497 V	SPLIT	FKM
7.625	8.625	.500	0762 3862	SPLIT	NBR
7.625	8.625	.500	0762 15335	SPLIT	NBR
7.625	8.625	.500	5291 H1L5	LUP	NBR
7.625	8.625	.500	5291 H5L16	LUP	FKM
7.625	8.625	.500	5291 H5L89	LUP	FKM
7.625	8.625	.625	0762 18236	SPLIT	NBR
7.625	8.875	.625	8432 H1L5	RUP	NBR
7.625	8.875	.625	8432 H1L5 PTFE	RUP	N/P
7.625	8.875	.625	8432 H5L16	RUP	FKM
7.625	8.875	.625	0762 4558	SPLIT	NBR
7.625	8.875	.625	0762 4558 V	SPLIT	FKM
7.625	9.120	.500	9778 ALLL5	RPDT	NBR
7.625	9.125	.625	17780 H1L5	LDS	NBR
7.625	9.125	.625	9360 H1L5	LUP	NBR
7.625	9.125	.625	9360 H1L7	LUP	NBR
7.625	9.125	.625	9360 H5L16	LUP	FKM
7.625	9.125	.625	15484	SDS	NBR
7.625	9.125	.625	0762 8847	SPLIT	NBR
7.625	9.125	.750	12365 H1L5	LUP	NBR
7.625	9.125	.750	12365 H5L16	LUP	FKM
7.625	9.125	.750	15465 H1L5	RUP	NBR
7.625	9.125	.750	15465 H5L16	RUP	FKM
7.625	9.125	.750	0762 10787	SPLIT	NBR
7.625	9.125	.750	0762 10787 V	SPLIT	FKM
7.625	9.250	.750	10092 H1L5	LPD	NBR
7.625	9.250	.750	10092 H5L16	LPD	FKM
7.648	8.500	.625	17338 H1L5	LUP	NBR
7.656	9.219	.750	13756 H1L5	RPD	NBR
7.656	9.219	.750	13756 H5L16	RPD	FKM
7.657	8.657	.438	0765 10497	SPLIT	NBR
7.657	9.150	.625	0765 8847	SPLIT	NBR
7.688	8.688	.438	0768 10497	SPLIT	NBR
7.688	9.188	.625	0768 8847	SPLIT	NBR
7.688	9.188	.750	9420 H1L5	RUP	NBR
7.688	9.188	.750	9420 H5L16	RUP	FKM
7.688	9.188	.750	0768 10787	SPLIT	NBR
7.688	9.188	.750	0768 14282	SPLIT	NBR
7.688	9.313	.750	0768 17619	SPLIT	NBR
7.690	8.940	.625	0769 4558	SPLIT	NBR
7.701	9.201	.625	0770 8847	SPLIT	NBR
7.719	8.719	.438	0771 10497	SPLIT	NBR
7.719	8.969	.625	0771 4558	SPLIT	NBR
7.719	9.219	.750	0771 10787 V	SPLIT	FKM
7.750	8.465	.472	19149 H1L7	P	NBR
7.750	8.750	.438	9595 H1L5	LUP	NBR
7.750	8.750	.438	9595 H1L5 PTFE	LUP	N/P
7.750	8.750	.438	9595 H5L16	LUP	FKM
7.750	8.750	.438	3862 H1L21	RPD	EPDM
7.750	8.750	.438	3862 H1L5	RPD	NBR
7.750	8.750	.438	3862 H5L16	RPD	FKM
7.750	8.750	.438	0775 3774	SPLIT	NBR

See Section 4 for seal type description. For High Misalignment sizes, see Page B-86. For FlexiSeal Listings, see Pages B-93 and B-97.

03/03/06





Shaft Dia.	Bore Dia.	Seal Width	Parker Part Number	Seal Type	Material
7.750	8.750	.438	0775 3774 V	SPLIT	FKM
7.750	8.750	.438	0775 10497	SPLIT	NBR
7.750	8.750	.438	0775 10497 V	SPLIT	FKM
7.750	8.750	.500	16750 H1L5	LUPW	NBR
7.750	8.750	.500	16750 H5L16	LUPW	FKM
7.750	8.750	.500	0775 15335	SPLIT	NBR
7.750	8.750	.594	11987 H1L7	P	NBR
7.750	8.750	.625	18236 H1L5	RUP	NBR
7.750	8.750	.625	18236 H5L16	RUP	FKM
7.750	9.000	.625	8941 H1L5	LUP	NBR
7.750	9.000	.625	8941 H5L16	LUP	FKM
7.750	9.000	.625	0775 18075	SPLIT	NBR
7.750	9.000	.625	0775 4558	SPLIT	NBR
7.750	9.000	.625	0775 4558 V	SPLIT	FKM
7.750	9.000	.625	0775 6511	SPLIT	NBR
7.750	9.188	.750	0775 12448	SPLIT	NBR
7.750	9.250	.625	10688 H1L5	LPD	NBR
7.750	9.250	.625	10688 H5L16	LPD	FKM
7.750	9.250	.625	17444 H1L5	LUPW	NBR
7.750	9.250	.625	0775 3581	SPLIT	NBR
7.750	9.250	.625	0775 8847	SPLIT	NBR
7.750	9.250	.625	0775 8847 V	SPLIT	FKM
7.750	9.250	.750	15527 H1L5	LDS	NBR
7.750	9.250	.750	8952 H1L5	LUP	NBR
7.750	9.250	.750	8952 H5L16	LUP	FKM
7.750	9.250	.750	0775 10787	SPLIT	NBR
7.750	9.250	.750	0775 10787 V	SPLIT	FKM
7.750	9.250	1.000	5089 H1L5	RPD	NBR
7.750	9.375	.625	15460 ALLL16	LPDW	FKM
7.750	9.375	.625	15460 ALLL3	LPDW	CR
7.750	9.375	.625	15460 H1L5	LPDW	NBR
7.750	9.375	.625	15460 H5L16	LPDW	FKM
7.750	9.375	.625	19724 ALLL16	LPDW	FKM
7.750	9.375	.750	0775 17619	SPLIT	NBR
7.750	9.750	1.000	0775 10689	SPLIT	NBR
7.750	10.000	.438	8806 H1L5	LPD	NBR
7.750	11.250	.500	19369 H1L5	LUP	NBR
7.750	11.250	.500	19369 H5L16	LUP	FKM
7.760	8.875	.344	9647 H1L7	SS	NBR
7.760	8.875	.469	70013 H1L5	TSS	NBR
7.782	8.782	.438	0778 3774	SPLIT	NBR
7.782	9.032	.625	0778 4558	SPLIT	NBR
7.813	8.810	.438	0781 10497	SPLIT	NBR
7.813	8.813	.438	0781 3774	SPLIT	NBR
7.813	8.813	.438	0781 3774 V	SPLIT	FKM
7.813	9.063	.625	0781 4558	SPLIT	NBR
7.813	9.250	.750	0781 12448	SPLIT	NBR
7.813	9.310	.625	0781 8847	SPLIT	NBR
7.813	9.313	.750	0781 14282	SPLIT	NBR
7.813	9.345	.375	17017 H1L5	LUPW	NBR
7.813	9.813	1.000	0781 10689	SPLIT	NBR
7.835	9.449	.787	19572 H1L5	RUP	NBR
7.844	9.344	.625	0784 8847	SPLIT	NBR
7.870	9.055	.591	19411 H1L5	LUP	NBR
7.870	9.055	.591	19411 H1L21	LUP	EPDM
7.870	9.055	.591	19411 H5L16	LUP	FKM
7.874	8.465	.472	15601 H1L7	P	NBR
7.874	9.055	.591	18528 H1L5	LUP	NBR
7.874	9.055	.591	18528 H1L5 PTFE	LUP	N/P
7.874	9.055	.591	18528 H5L16	LUP	FKM
7.874	9.312	.750	0787 12448	SPLIT	NBR
7.874	9.440	.630	20608 H5MX5489	LDS	FKM
7.874	9.449	.630	18950 H1L5	LUP	NBR
7.874	9.449	.630	18950 H5L16	LUP	FKM
7.875	8.695	.343	0787 18802	SPLIT	NBR
7.875	9.000	.438	9832 H1L5	LUP	NBR

Shaft Dia.	Bore Dia.	Seal Width	Parker Part Number	Seal Type	Material
7.875	9.000	.438	9832 H1L70	LUP	NBR
7.875	9.000	.438	9832 H5L16	LUP	FKM
7.875	8.875	.438	0787 10497	SPLIT	NBR
7.875	8.875	.438	0787 3774	SPLIT	NBR
7.875	8.875	.438	0787 3774 H1L70	SPLIT	NBR
7.875	8.875	.438	0787 3774 V	SPLIT	FKM
7.875	8.875	.500	0787 15335	SPLIT	NBR
7.875	9.125	.625	0787 4558	SPLIT	NBR
7.875	9.125	.625	0787 4558 V	SPLIT	FKM
7.875	9.258	1.000	15589 H1L5	LDS	NBR
7.875	9.375	.625	0787 8847	SPLIT	NBR
7.875	9.375	.625	0787 8847 V	SPLIT	FKM
7.875	9.375	.625	9886 H1L5	LUP	NBR
7.875	9.375	.625	9886 H1L50	LUP	NBR
7.875	9.375	.625	9886 H1L70	LUP	NBR
7.875	9.375	.750	10021 H1L5	LUP	NBR
7.875	9.375	.750	10021 H5L16	LUP	FKM
7.875	9.375	.750	10787 H1L5	RUP	NBR
7.875	9.375	.750	10787 H5L16	RUP	FKM
7.875	9.375	.750	0787 14282	SPLIT	NBR
7.875	9.375	.750	0787 14282 V	SPLIT	FKM
7.875	9.500	.750	0787 17619	SPLIT	NBR
7.875	10.000	1.463	17148 H1L5	LUPW	NBR
7.906	9.157	.625	0790 6511	SPLIT	NBR
7.906	9.407	.750	0790 14282	SPLIT	NBR
7.938	8.750	.344	17584 H1L7	SS	NBR
7.938	8.757	.343	0793 18802	SPLIT	NBR
7.938	8.938	.438	0793 3774	SPLIT	NBR
7.938	9.188	.625	0793 6511	SPLIT	NBR
7.938	9.188	.625	0793 6511 V	SPLIT	FKM
7.938	9.438	.625	0793 3581	SPLIT	NBR
7.938	9.438	.750	0793 14282	SPLIT	NBR
7.938	9.938	1.000	0793 10689	SPLIT	NBR
7.938	10.125	.500	20772 H5L16	LUP	FKM
7.938	10.125	.500	20816 H5L16	LDS	FKM
7.969	8.969	.438	0796 3774	SPLIT	NBR
8.000	9.000	.438	10497 H1L5	RUP	NBR
8.000	9.000	.438	10497 H5L16	RUP	FKM
8.000	9.000	.438	0800 3774	SPLIT	NBR
8.000	9.000	.438	0800 3774 V	SPLIT	FKM
8.000	9.000	.438	0800 4905	SPLIT	NBR
8.000	9.000	.500	0800 15335	SPLIT	NBR
8.000	9.000	.500	16016 ALLL5	RUPOL	NBR
8.000	9.000	.625	16080 H1L5	LDS	NBR
8.000	9.000	.625	16080 H1L70	LDS	NBR
8.000	9.000	.625	9191 H1L5	LUP	NBR
8.000	9.000	.625	9191 H1L70	LUP	NBR
8.000	9.000	.625	9191 H5L16	LUP	FKM
8.000	9.000	.625	9191 H5L16 PTFE	LUP	F/P
8.000	9.000	.625	19451 H1L20	LUPW	XNBR
8.000	9.000	.625	19451 H1L7	LUPW	NBR
8.000	9.000	.625	0800 19209	SPLIT	NBR
8.000	9.000	.938	6536 H1L7	OLSS	NBR
8.000	9.000	.938	6536 H3L8	OLSS	CR
8.000	9.055	.500	10711 H1L18	OLRUP	H1L18
8.000	9.055	.500	10711 H1L5	OLRUP	NBR
8.000	9.055	.500	10711 H5L89	OLRUP	H5L89
8.000	9.125	.625	12741 H1L5	LUP	NBR
8.000	9.125	.625	12741 H5L16	LUP	FKM
8.000	9.250	.625	17772 5066	HP	FKM
8.000	9.250	.625	17772 5066 304	HP	FKM
8.000	9.250	.625	17772 5066 316	HP	FKM
8.000	9.250	.625	11035 H1L5	LUP	NBR
8.000	9.250	.625	11035 H1L5 PTFE	LUP	N/P
8.000	9.250	.625	11035 H1L70	LUP	NBR
8.000	9.250	.625	11035 H5L16	LUP	FKM

See Section 4 for seal type description. For High Misalignment sizes, see Page B-86. For FlexiSeal Listings, see Pages B-93 and B-97.

03/03/06



B

Shaft Dia.	Bore Dia.	Seal Width	Parker Part Number	Seal Type	Material
8.000	9.250	.625	19346	MP	FKM
8.000	9.250	.625	4558 H1L5	RUP	NBR
8.000	9.250	.625	4558 H1L5 PTFE	RUP	N/P
8.000	9.250	.625	4558 H5L16	RUP	FKM
8.000	9.250	.625	4558 H5L16 PTFE	RUP	F/P
8.000	9.250	.625	0800 18075	SPLIT	NBR
8.000	9.250	.625	0800 6511	SPLIT	NBR
8.000	9.250	.625	0800 6511 H1L70	SPLIT	NBR
8.000	9.250	.625	0800 6511 V	SPLIT	FKM
8.000	9.250	.750	16865 H1L5	LDS	NBR
8.000	9.375	.625	16550 H1L5	LUP	NBR
8.000	9.438	.750	0800 12448	SPLIT	NBR
8.000	9.500	.625	8847 H1L2160	RUP	EPDM
8.000	9.500	.625	8847 H1L5	RUP	NBR
8.000	9.500	.625	8847 H5L16	RUP	FKM
8.000	9.500	.625	40002 H5L16	SPC	FKM
8.000	9.500	.625	0800 3581	SPLIT	NBR
8.000	9.500	.625	0800 3581 V	SPLIT	FKM
8.000	9.500	.625	TMAL 9500-4048	TMAL	PTFE
8.000	9.500	.750	4491 H1L5	B	NBR
8.000	9.500	.750	14032 H1L5	LPDW	NBR
8.000	9.500	.750	14032 H5L16	LPDW	FKM
8.000	9.500	.750	12929 H1L5	LUP	NBR
8.000	9.500	.750	12929 H5L16	LUP	FKM
8.000	9.500	.750	0800 6633	SPLIT	NBR
8.000	9.500	.750	0800 6633 V	SPLIT	FKM
8.000	10.000	.438	0800 3775	SPLIT	NBR
8.000	10.000	.685	14198 H1L5	LUP	NBR
8.000	10.000	.685	14198 H5MX5489	LUP	FKM
8.000	10.000	.750	16311 H1L5	LUP	NBR
8.000	10.000	.750	0800 7087	SPLIT	NBR
8.000	10.000	.906	15076 H1L5	LDS	NBR
8.000	10.000	.906	15076 H5L16	LDS	FKM
8.000	10.000	1.000	0800 10689	SPLIT	NBR
8.000	10.010	.750	5609 H1L5	LUP	NBR
8.000	10.125	1.188	16525 H1L5	LDS	NBR
8.000	10.250	.750	15061 H1L5	SSW	NBR
8.000	11.625	.813	15199 H1L5	LDS	NBR
8.013	9.263	.625	0801 6511	SPLIT	NBR
8.045	9.906	.583	14737 H1L5	LPDW	NBR
8.045	9.906	.583	14737 H5L16	LPDW	FKM
8.060	10.060	1.000	0806 10689	SPLIT	NBR
8.063	8.882	.344	18802 H1L5	RUP	NBR
8.063	9.063	.438	0806 3774	SPLIT	NBR
8.063	9.563	.750	0806 6633	SPLIT	NBR
8.063	9.563	.750	14282 H1L5	RPD	NBR
8.063	9.563	.750	14282 H5L16	RPD	FKM
8.125	9.125	.438	0812 3774	SPLIT	NBR
8.125	9.125	.438	0812 3774 PTFE	SPLIT	NBR
8.125	9.125	.438	0812 3774 V	SPLIT	FKM
8.125	9.375	.625	10656 H1L5	LUP	NBR
8.125	9.375	.625	18075 H1L5	RUP	NBR
8.125	9.375	.625	0812 6511	SPLIT	NBR
8.125	9.625	.625	0812 3581	SPLIT	NBR
8.125	9.625	.750	13777 H1L5	LDS	NBR
8.125	9.625	.750	11136 H1L5	LPD	NBR
8.125	9.625	.750	0812 6633	SPLIT	NBR
8.125	9.750	.750	17619 H1L5	RUP	NBR
8.125	10.125	1.000	10700 H1L5	LPD	NBR
8.125	10.135	.750	10347 H1L5	LUP	NBR
8.125	10.312	.625	0812 3604	SPLIT	NBR
8.157	9.657	.625	0815 4118	SPLIT	NBR
8.188	9.188	.500	15335 H1L5	RUP	NBR
8.188	9.188	.500	15335 H5L16	RUP	FKM
8.188	10.188	1.000	10689 H1L5	RUP	NBR
8.200	9.700	.625	0820 4118	SPLIT	NBR

Shaft Dia.	Bore Dia.	Seal Width	Parker Part Number	Seal Type	Material
8.245	11.000	.750	18031 H1L5	SSW	NBR
8.250	9.250	.438	3774 H1L5	RUP	NBR
8.250	9.250	.438	3774 H1L70	RUP	NBR
8.250	9.250	.438	3774 H5L16	RUP	FKM
8.250	9.250	.438	0825 4905	SPLIT	NBR
8.250	9.250	.500	12350 H1L7	H	NBR
8.250	9.250	.625	16220 H1L5	LUP	NBR
8.250	9.250	.625	0825 19209	SPLIT	NBR
8.250	9.250	.625	16220 H5L16	LUP	FKM
8.250	9.500	.625	9224 H1L5	LUP	NBR
8.250	9.500	.625	9224 H5L16	LUP	FKM
8.250	9.500	.625	9224 H5MX5489	LUP	FKM
8.250	9.500	.625	19447 H5MX5489	LUPW	FKM
8.250	9.500	.625	6511 H1L5	RUP	NBR
8.250	9.500	.625	6511 H1L70	RUP	NBR
8.250	9.500	.625	6511 H5L16	RUP	FKM
8.250	9.500	.625	0825 9857	SPLIT	NBR
8.250	9.500	.625	0825 9857 V	SPLIT	FKM
8.250	9.500	.625	TMAL 9500-4040	TMAL	PTFE
8.250	9.500	.750	0825 9372	SPLIT	NBR
8.250	9.500	.750	9291 H1L5	LUP	NBR
8.250	9.500	.750	9291 H1L7	LUP	NBR
8.250	9.500	.750	9291 H5L16	LUP	FKM
8.250	9.628	.625	0825 15719	SPLIT	NBR
8.250	9.688	.750	12448 H1L5	RPD	NBR
8.250	9.750	.625	3581 H1L5	RUP	NBR
8.250	9.750	.625	3581 H5L16	RUP	FKM
8.250	9.750	.625	0825 4118	SPLIT	NBR
8.250	9.750	.625	0825 4118 V	SPLIT	FKM
8.250	9.750	.750	0825 6633	SPLIT	NBR
8.250	9.750	.750	11747 H1L5	LPD	NBR
8.250	10.000	.750	17035 H1L20	LUP	XNBR
8.250	10.000	.750	17035 H1L5	LUP	NBR
8.250	10.250	.813	17904 H1L5	LUPW	NBR
8.250	10.250	.813	17904 H5L16	LUPW	FKM
8.250	10.260	.688	12149 H1L5	LUP	NBR
8.250	10.260	.688	12149 H1L5 PTFE	LUP	N/P
8.250	10.260	.688	12149 H5L16	LUP	FKM
8.250	10.500	1.342	18037 H1L5	LPDW	NBR
8.250	11.000	1.650	20542 H1L5	LUP	NBR
8.267	9.450	.591	0826 18676	SPLIT	NBR
8.268	9.449	.590	80166 H1L5	MIST	NBR
8.268	9.449	.591	30213 H1L5	RUP	NBR
8.268	9.843	.591	30209 H1L5	LUP	NBR
8.282	9.532	.625	0828 9857	SPLIT	NBR
8.282	9.532	.750	0828 12577	SPLIT	NBR
8.282	9.782	.750	0828 6633	SPLIT	NBR
8.313	9.101	.394	19519 ALLL5	SPCL	NBR
8.313	9.313	.438	0831 4905	SPLIT	NBR
8.313	9.563	.625	0831 9857	SPLIT	NBR
8.313	9.563	.750	0831 9372	SPLIT	NBR
8.313	9.813	.750	0831 6633	SPLIT	NBR
8.313	10.313	1.000	0831 10276	SPLIT	NBR
8.344	9.594	.750	0834 9372	SPLIT	NBR
8.375	9.375	.438	0837 4905	SPLIT	NBR
8.375	9.624	.750	0837 12577	SPLIT	NBR
8.375	9.625	.625	0837 9857	SPLIT	NBR
8.375	9.625	.625	0837 9857 V	SPLIT	FKM
8.375	9.626	.750	0837 9372	SPLIT	NBR
8.375	9.750	.500	19847 H1L5 PTFE	STLUP	N/P
8.375	9.750	.625	0837 15719	SPLIT	NBR
8.375	9.750	.625	0837 16351	SPLIT	NBR
8.375	9.750	.750	10541 H1L5	STLUP	NBR
8.375	9.750	.750	10541 H1L5 PTFE	STLUP	N/P
8.375	9.875	.625	0837 4118	SPLIT	NBR
8.375	9.875	.625	0837 4118 V	SPLIT	FKM

See Section 4 for seal type description. For High Misalignment sizes, see Page B-86. For FlexiSeal Listings, see Pages B-93 and B-97.

03/03/06



B

Shaft Dia.	Bore Dia.	Seal Width	Parker Part Number	Seal Type	Material
8.375	9.875	.688	6718 H1L5	LUP	NBR
8.375	9.875	.688	6718 H5L16	LUP	FKM
8.375	9.875	.750	0837 6633	SPLIT	NBR
8.375	9.938	.750	0837 13755	SPLIT	NBR
8.375	10.375	1.000	0837 10276	SPLIT	NBR
8.375	10.383	.750	13444 H1L5	LUP	NBR
8.375	10.383	.750	13444 H1L5 PTFE	LUP	N/P
8.375	10.383	.750	13444 H1L70	LUP	NBR
8.375	10.403	.785	9138 H1L5	SSW	NBR
8.375	10.403	.785	9138 H5MX5489	SSW	FKM
8.375	10.500	.935	14428 H1L5	LPDW	NBR
8.438	9.688	.625	0843 9857	SPLIT	NBR
8.438	10.000	.625	16551 H1L5	LUP	NBR
8.438	10.000	.625	16551 H5MX5489	LUP	FKM
8.438	10.438	1.000	0843 10276	SPLIT	NBR
8.450	9.637	.688	16453 ALLL5	SPEC	NBR
8.464	9.644	.787	19025 ALLL5	SPCL	NBR
8.469	9.837	.625	0846 15719	SPLIT	NBR
8.469	9.968	.375	0846 15735	SPLIT	NBR
8.480	9.563	.469	70015 H1L5	TSS	NBR
8.500	9.500	.375	15932 H1L5	OLLUP	NBR
8.500	9.500	.375	15932 H5L16	OLLUP	FKM
8.500	9.500	.438	4889 H5L16	LUP	FKM
8.500	9.500	.438	4905 H1L5	RPD	NBR
8.500	9.500	.438	4905 H5L16	RPD	FKM
8.500	9.500	.438	0850 5280	SPLIT	NBR
8.500	9.500	.438	0850 5280 V	SPLIT	FKM
8.500	9.500	.437	TMAL 9500-2832	TMAL	PTFE
8.500	9.500	.500	19747 H1L7	SS	NBR
8.500	9.500	.594	12606 H1L7	P	NBR
8.500	9.500	.625	16552 H1L5	LUP	NBR
8.500	9.500	.625	16552 H5L16	LUP	FKM
8.500	9.500	.625	16552 H5L89	LUP	FKM
8.500	9.500	.625	15809 H1L5	OLLDS	NBR
8.500	9.500	.625	19209 H1L5	RPD	NBR
8.500	9.750	.625	15959 H1L5	LUP	NBR
8.500	9.750	.625	15959 H1L70	LUP	NBR
8.500	9.750	.625	15959 H5L16	LUP	FKM
8.500	9.750	.625	0850 3577	SPLIT	NBR
8.500	9.750	.625	0850 3577 V	SPLIT	FKM
8.500	9.750	.625	0850 9857	SPLIT	NBR
8.500	9.750	.625	0850 9857 H1L70	SPLIT	NBR
8.500	9.750	.625	0850 9857 V	SPLIT	FKM
8.500	9.750	.688	4535 H1L5	LUP	NBR
8.500	9.750	.688	4535 H5L16	LUP	FKM
8.500	9.750	.688	13552 H1L5	RUP	NBR
8.500	9.750	.750	0850 12577	SPLIT	NBR
8.500	9.750	.750	0850 12577 V	SPLIT	FKM
8.500	9.750	.750	0850 9372	SPLIT	NBR
8.500	9.750	.750	0850 9372 V	SPLIT	FKM
8.500	10.000	.375	0850 15735	SPLIT	NBR
8.500	10.000	.625	4118 H1L5	RUP	NBR
8.500	10.000	.625	4118 H5L16	RUP	FKM
8.500	10.000	.625	0850 3604	SPLIT	NBR
8.500	10.000	.625	0850 3604 V	SPLIT	FKM
8.500	10.000	.625	TMAL 10000-4048	TMAL	PTFE
8.500	10.000	.750	15382 H1L5	LDS	NBR
8.500	10.000	.750	15382 H5MX5489	LDS	FKM
8.500	10.000	.750	10371 H1L5	LUP	NBR
8.500	10.000	.750	10371 H1L5 PTFE	LUP	N/P
8.500	10.000	.750	19542 H5L16	LUP	FKM
8.500	10.000	.750	6633 H1L5	RUP	NBR
8.500	10.000	.750	6633 H5L16	RUP	FKM
8.500	10.000	.750	0850 9727	SPLIT	NBR
8.500	10.063	.750	0850 13755	SPLIT	NBR
8.500	10.250	.375	16264 H1L5	SSW	NBR

Shaft Dia.	Bore Dia.	Seal Width	Parker Part Number	Seal Type	Material
8.500	10.500	.688	16964 H1L5	LUP	NBR
8.500	10.500	.688	16964 H5L16	LUP	FKM
8.500	10.500	.750	8954 H1L5	LUP	NBR
8.500	10.500	.750	16930 H1L5	LUPW	NBR
8.500	10.500	.750	0850 7087	SPLIT	NBR
8.500	10.500	1.000	8835 H1L5	LUP	NBR
8.500	10.500	1.000	0850 10276	SPLIT	NBR
8.500	10.500	1.000	0850 7236	SPLIT	NBR
8.500	10.625	1.000	15024 H1L5	LDS	NBR
8.500	10.870	.500	19034 ALLL5	RPDT	NBR
8.500	11.000	.750	20405 H1L20	LUPW-ST	XNBR
8.500	11.000	.750	0850 19870	SPLIT	NBR
8.500	11.000	.750	20405 H1L5	STLUPW	NBR
8.500	11.250	.963	80105 H5MX5489	MIST-EL	FKM
8.500	11.625	1.078	15156 H1L5	LDS	NBR
8.500	12.500	1.000	0850 12590	SPLIT	NBR
8.532	9.782	.625	0853 9857	SPLIT	NBR
8.563	9.812	.625	0853 9857	SPLIT	NBR
8.563	9.813	.625	0856 9857	SPLIT	NBR
8.563	9.938	.625	15719 H1L5	RUP	NBR
8.563	9.938	.625	16351 H1L5	RUP	NBR
8.563	10.563	1.000	0856 10276	SPLIT	NBR
8.563	12.563	1.000	0856 12590	SPLIT	NBR
8.594	10.094	.625	0859 3604	SPLIT	NBR
8.594	10.157	.750	0859 13755	SPLIT	NBR
8.594	10.594	1.000	0859 10276	SPLIT	NBR
8.625	9.625	.438	0862 5280	SPLIT	NBR
8.625	9.625	.438	0862 5280 V	SPLIT	FKM
8.625	9.625	.500	10020 H1L5	LUP	NBR
8.625	9.625	.500	10020 H5L16	LUP	FKM
8.625	9.875	.625	0862 3577	SPLIT	NBR
8.625	9.875	.625	0862 9857	SPLIT	NBR
8.625	10.000	.500	16988 H1L20	LUP	XNBR
8.625	10.000	.500	16988 H1L5	LUP	NBR
8.625	10.000	.500	16988 H1L5 PTFE	LUP	N/P
8.625	10.125	.625	0862 3604	SPLIT	NBR
8.625	10.500	.500	15896 H1L5	LPD	NBR
8.625	10.625	.750	12441 H1L5	LPD	NBR
8.625	10.625	.750	12441 H5L16	LPD	FKM
8.625	10.625	.750	TMAL 10625-4864	TMAL	PTFE
8.625	10.625	1.000	0862 10276	SPLIT	NBR
8.625	10.625	1.000	0862 7236	SPLIT	NBR
8.630	10.130	.625	0863 3604	SPLIT	NBR
8.640	9.890	.625	0864 3577	SPLIT	NBR
8.656	9.657	.438	0865 5280	SPLIT	NBR
8.656	9.907	.625	0865 3577	SPLIT	NBR
8.656	10.157	.625	0865 3604	SPLIT	NBR
8.656	10.219	.750	0865 13755	SPLIT	NBR
8.660	9.843	.591	0866 19124	SPLIT	NBR
8.660	9.843	.591	30096 H5L89	LUP	FKM
8.661	9.842	.591	17208 H1L5	STLUP	NBR
8.661	9.842	.591	17208 H5L16	STLUP	FKM
8.661	9.844	.591	18676 H1L5	RUP	NBR
8.661	9.844	.591	18676 H5L16	RUP	FKM
8.661	10.161	.625	0866 3604	SPLIT	NBR
8.661	10.236	.591	30210 H1L5	RUP	NBR
8.688	9.688	.438	0868 5280	SPLIT	NBR
8.688	9.938	.625	0868 3577	SPLIT	NBR
8.688	9.938	.750	12577 H1L5	RUP	NBR
8.688	9.938	.750	12577 H5L16	RUP	FKM
8.688	9.938	.750	12577 H5MX5489	RUP	FKM
8.688	9.938	.750	9372 H1L5	RUP	NBR
8.688	9.938	.750	9372 H5L16	RUP	FKM
8.688	10.180	.500	11367 ALLL5	RPDT	NBR
8.688	10.188	.625	0868 3604	SPLIT	NBR
8.750	9.500	.375	0875 9123	SPLIT	NBR

See Section 4 for seal type description. For High Misalignment sizes, see Page B-86. For FlexiSeal Listings, see Pages B-93 and B-97.

03/03/06



Rotary Lip Seal Inch Sizes

8.750 to 9.188

B

Shaft Dia.	Bore Dia.	Seal Width	Parker Part Number	Seal Type	Material
8.750	9.688	.563	12110 ALLL7	P	NBR
8.750	9.750	.438	0875 5280	SPLIT	NBR
8.750	9.750	.438	0875 5280 V	SPLIT	FKM
8.750	9.750	.563	9303 H1L5	LUP	NBR
8.750	9.750	.563	9303 H5L16	LUP	FKM
8.750	10.000	.625	9557 H1L5	LUP	NBR
8.750	10.000	.625	9557 H5L16	LUP	FKM
8.750	10.000	.625	9857 H1L5	RUP	NBR
8.750	10.000	.625	9857 H1L70	RUP	NBR
8.750	10.000	.625	9857 H5L16	RUP	FKM
8.750	10.000	.625	0875 3577	SPLIT	NBR
8.750	10.000	.625	0875 3577 V	SPLIT	FKM
8.750	10.000	.625	0875 9823	SPLIT	NBR
8.750	10.124	.500	12413 414	DS	CR
8.750	10.250	.375	0875 15735	SPLIT	NBR
8.750	10.250	.375	0875 15735 V	SPLIT	FKM
8.750	10.250	.625	0875 3604	SPLIT	NBR
8.750	10.250	.688	16553 H1L5	LUP	NBR
8.750	10.250	.688	17902 H1L5	LUPW	NBR
8.750	10.250	.688	17902 H5L16	LUPW	FKM
8.750	10.750	.750	13789 H1L5	LUP	NBR
8.750	10.750	.750	13789 H1L70	LUP	NBR
8.750	10.250	.750	0875 9727	SPLIT	NBR
8.750	10.500	.750	0875 14747	SPLIT	NBR
8.750	10.750	.750	0875 7087	SPLIT	NBR
8.750	10.500	.750	16179 H1L5	STLUP	NBR
8.750	10.750	1.000	0875 10276	SPLIT	NBR
8.750	10.875	1.000	0875 7236	SPLIT	NBR
8.750	11.250	.750	19870 H1L5	RUPW	NBR
8.813	10.313	.625	0881 3604	SPLIT	NBR
8.844	9.844	.438	0844 5280	SPLIT	NBR
8.844	9.844	.438	0884 5280	SPLIT	NBR
8.844	10.406	.750	13755 H1L5	RPD	NBR
8.875	9.875	.438	0887 5280	SPLIT	NBR
8.875	10.125	.625	10333 H1L5	LUP	NBR
8.875	10.125	.625	0887 3577	SPLIT	NBR
8.875	10.125	.750	9292 H1L5	LPD	NBR
8.875	10.375	.625	0887 3604	SPLIT	NBR
8.875	10.375	.750	0887 9727	SPLIT	NBR
8.875	10.875	.750	13436 H1L5	LPD	NBR
8.875	10.875	.750	0887 7087	SPLIT	NBR
8.875	10.875	1.000	8943 H1L5	LPD	NBR
8.875	10.875	1.000	0887 10276	SPLIT	NBR
8.875	11.250	.625	17770 H1L5	LDS	NBR
8.938	10.438	.375	15735 H1L5	RPD	NBR
8.938	10.438	.375	15735 H5L16	RPD	FKM
8.938	10.438	.750	0893 9727	SPLIT	NBR
8.938	10.688	.750	0893 14747	SPLIT	NBR
8.938	10.938	.750	0893 7087	SPLIT	NBR
8.938	10.938	1.000	0893 7236	SPLIT	NBR
8.950	9.950	.375	19678 H1L5	LUP	NBR
8.969	10.969	1.000	0896 7236	SPLIT	NBR
9.000	9.750	.375	0900 9123	SPLIT	NBR
9.000	10.000	.438	5280 H1L5	RPD	NBR
9.000	10.000	.438	5280 H5L16	RPD	FKM
9.000	10.000	.438	0900 3775	SPLIT	NBR
9.000	10.000	.438	0900 3775 V	SPLIT	FKM
9.000	10.000	.469	5386 H1L5	LUP	NBR
9.000	10.000	.469	5386 H1L5 PTFE	LUP	N/P
9.000	10.000	.469	5386 H5L16	LUP	FKM
9.000	10.000	.563	13711 ALLL7	P	NBR
9.000	10.000	.625	20718 H1L5	LUP	NBR
9.000	10.000	.750	11552 H1L5	LUP	NBR
9.000	10.000	.750	11552 H5MX5489	LUP	FKM
9.000	10.250	.625	16554 H1L5	LUP	NBR
9.000	10.250	.625	3577 H1L5	RUP	NBR

Shaft Dia.	Bore Dia.	Seal Width	Parker Part Number	Seal Type	Material
9.000	10.250	.625	0900 9823	SPLIT	NBR
9.000	10.250	.625	0900 9823 V	SPLIT	FKM
9.000	10.250	.625	3577 H5L16	RUP	FKM
9.000	10.500	.500	0900 9878	SPLIT	NBR
9.000	10.500	.625	19586 H5L16	LUPW	FKM
9.000	10.500	.625	19586 H5MX5489	LUPW	FKM
9.000	10.500	.625	19586 H5MX9514	LUPW	FKM
9.000	10.500	.625	3604 H1L5	RUP	NBR
9.000	10.500	.625	3604 H5L16	RUP	FKM
9.000	10.500	.625	3604 H5L16 PTFE	RUP	F/P
9.000	10.500	.688	17912 H1L5	LUPW	NBR
9.000	10.500	.750	14490 H1L5	LDS	NBR
9.000	10.500	.750	14490 H5L16	LDS	FKM
9.000	10.750	.750	13760 H1L5	LPD	NBR
9.000	10.750	.750	13760 H5L16	LPD	FKM
9.000	10.500	.750	8868 H1L5	LUP	NBR
9.000	10.500	.750	8868 H5L16	LUP	FKM
9.000	10.500	.750	8868 H5L16 PTFE	LUP	F/P
9.000	10.500	.750	0900 10634	SPLIT	NBR
9.000	10.500	.750	0900 9727	SPLIT	NBR
9.000	10.500	.750	0900 9727 V	SPLIT	FKM
9.000	10.750	1.068	19990 H1L5	LUPW	NBR
9.000	11.000	.750	8948 H1L5	LUP	NBR
9.000	11.000	.750	8948 H1L7	LUP	NBR
9.000	11.000	.750	8948 H5L16	LUP	FKM
9.000	11.000	.750	19325	MP	FKM
9.000	11.000	.750	0900 7087	SPLIT	NBR
9.000	11.000	.750	0900 7087 H1L20	SPLIT	XNBR
9.000	11.000	.750	0900 7087 V	SPLIT	FKM
9.000	11.000	.750	0900 9568	SPLIT	NBR
9.000	11.000	1.000	8819 H1L5	LUP	NBR
9.000	11.000	1.000	8819 H5L16	LUP	FKM
9.000	11.000	1.000	10276 H1L5	RPD	NBR
9.000	11.000	1.000	10276 H5L89	RPD	FKM
9.000	11.000	1.000	0900 3924	SPLIT	NBR
9.000	11.000	1.000	0900 7236	SPLIT	NBR
9.000	13.000	.500	17264 H1L5	SSW	NBR
9.000	13.000	.500	17264 H5L89	SSW	FKM
9.000	13.000	1.000	12590 ALLL5	RPD	NBR
9.063	10.063	.438	0906 3775	SPLIT	NBR
9.063	10.313	.625	0906 9823	SPLIT	NBR
9.063	10.563	.750	0906 9727	SPLIT	NBR
9.094	10.344	.625	16935 H1L5	LUP	NBR
9.094	10.344	.625	0909 9823	SPLIT	NBR
9.125	10.125	.438	0912 3775 V	SPLIT	FKM
9.125	10.375	.625	9891 H1L5	LUP	NBR
9.125	10.375	.625	0912 9823	SPLIT	NBR
9.125	10.375	.625	15354 H1L5	STLUP	NBR
9.125	10.625	.625	18822 H1L5	LUP	NBR
9.125	10.625	.688	16555 H1L5	LUPW	NBR
9.125	10.625	.688	16555 H5L89	LUPW	FKM
9.125	10.625	.750	0912 9727	SPLIT	NBR
9.125	11.125	.750	0912 7087	SPLIT	NBR
9.125	11.125	.750	0912 9568	SPLIT	NBR
9.125	11.125	.813	16556 H1L5	LUPW	NBR
9.125	11.125	1.000	7236 H1L20	RUP	XNBR
9.125	11.125	1.000	7236 H1L5	RUP	NBR
9.125	11.125	1.000	0912 3924	SPLIT	NBR
9.144	10.500	.469	70016 H1L5	TSS	NBR
9.157	10.157	.438	0915 3775	SPLIT	NBR
9.162	10.344	.591	19124 H1L5	RUP	NBR
9.181	11.125	.531	70014 H1L5	TSS	NBR
9.188	9.938	.375	9123 H1L5	R	NBR
9.188	10.438	.625	0918 9823	SPLIT	NBR
9.188	10.688	.750	0918 10634	SPLIT	NBR
9.188	10.688	.750	0918 9727	SPLIT	NBR

See Section 4 for seal type description. For High Misalignment sizes, see Page B-86. For FlexiSeal Listings, see Pages B-93 and B-97.

03/03/06



B

Shaft Dia.	Bore Dia.	Seal Width	Parker Part Number	Seal Type	Material
9.188	10.938	.750	14747 H1L5	RPD	NBR
9.188	11.188	.750	0918 9568	SPLIT	NBR
9.188	11.500	1.000	9536 H1L5	LPDW	NBR
9.188	11.500	1.000	9536 H5L16	LPDW	FKM
9.250	10.250	.438	0925 3775	SPLIT	NBR
9.250	10.250	.500	19474 H1L5	LUP	NBR
9.250	10.250	.500	0925 5604	SPLIT	NBR
9.250	10.250	.500	0925 5604 V	SPLIT	FKM
9.250	10.250	.594	0925 3704	SPLIT	NBR
9.250	10.375	.750	16557 H1L5	LUP	NBR
9.250	10.375	.750	16557 H5MX5489	LUP	FKM
9.250	10.375	.750	80073 H1L5	MIST	NBR
9.250	10.500	.375	0925 3375	SPLIT	NBR
9.250	10.500	.625	0925 9823	SPLIT	NBR
9.250	10.500	.625	15524 H1L5	STLPD	NBR
9.250	10.625	.500	0925 20754	SPLIT	FKM
9.250	10.750	.656	14370 H1L5	LUP	NBR
9.250	10.750	.656	14370 H5L16	LUP	FKM
9.250	10.750	.656	TMAL 10750-4248	TMAL	PTFE
9.250	10.750	.750	14929 H1L5	LDS	NBR
9.250	10.750	.750	14929 H5MX5489	LDS	FKM
9.250	10.750	.750	0925 9727	SPLIT	NBR
9.250	11.250	.500	12831 H1L5	STLPD	NBR
9.250	11.250	.625	17020 H1L3	LDS	CR
9.250	11.250	.625	17020 H1L5	LDS	NBR
9.250	11.250	.625	17020 H5L16	LDS	FKM
9.250	11.250	.750	16306 H1L5	LDS	NBR
9.250	11.250	.750	16306 H5L89	LDS	FKM
9.250	11.250	.750	7087 H1L20	RUP	XNBR
9.250	11.250	.750	7087 H1L5	RUP	NBR
9.250	11.250	.750	7087 H5L16	RUP	FKM
9.250	11.250	.750	0925 7087	SPLIT	NBR
9.250	11.250	.750	0925 9568	SPLIT	NBR
9.250	11.250	.750	0925 9568 V	SPLIT	FKM
9.250	11.250	1.000	10252 H1L5	LUP	NBR
9.250	11.250	1.000	0925 3924	SPLIT	NBR
9.250	11.500	.750	16782 H1L5	LUPW	NBR
9.250	11.500	.750	16782 H5L16	LUPW	FKM
9.250	11.500	1.342	18757 H1L5	LPDWEL	NBR
9.250	11.875	1.265	19216 H1L5	STLPDW	NBR
9.250	12.000	1.057	19908 H1L5	LUPWEL	NBR
9.250	12.625	1.000	0925 13855	SPLIT	NBR
9.250	12.758	1.250	14892 H1L5	LDS	NBR
9.282	10.532	.625	0928 9823	SPLIT	NBR
9.282	10.782	.750	0928 9727	SPLIT	NBR
9.300	9.934	.308	17099 ALLL16	MP	FKM
9.300	10.800	.750	0930 9727	SPLIT	NBR
9.313	10.313	.438	0931 3775	SPLIT	NBR
9.313	10.812	.750	0931 9727	SPLIT	NBR
9.344	11.344	.750	0934 9568	SPLIT	NBR
9.350	11.350	.750	0935 9568	SPLIT	NBR
9.359	10.750	.625	17135 H1L5	LDS	NBR
9.359	10.750	.625	17135 H1MX9508	LDS	HNBR
9.375	10.375	.500	0937 5604	SPLIT	NBR
9.375	10.506	.563	14185 H1L5	OLLPD	NBR
9.375	10.506	.563	14185 H1L21	OLLPD	EPDM
9.375	10.506	.563	14185 H1L30	OLLPD	HNBR
9.375	10.506	.563	14185 H5L89	OLLPD	FKM
9.375	10.625	.625	0937 9823	SPLIT	NBR
9.375	10.875	.750	0937 10634	SPLIT	NBR
9.375	10.875	.750	0937 9727	SPLIT	NBR
9.375	11.000	.750	0937 12323	SPLIT	NBR
9.375	11.375	.750	0937 9568	SPLIT	NBR
9.375	11.375	1.000	8823 H1L5	LPD	NBR
9.375	11.375	1.000	0937 3924	SPLIT	NBR
9.375	11.937	.750	0937 9742	SPLIT	NBR

Shaft Dia.	Bore Dia.	Seal Width	Parker Part Number	Seal Type	Material
9.410	11.025	.750	20677 H1L5	LUP	NBR
9.438	10.438	.500	0943 5604	SPLIT	NBR
9.438	10.688	1.000	0943 16364	SPLIT	NBR
9.438	10.938	.750	0943 10634	SPLIT	NBR
9.438	11.438	1.000	0943 3924	SPLIT	NBR
9.449	10.630	.591	30098 H1L20	LUP	XNBR
9.449	10.630	.591	30098 H5L89	LUP	FKM
9.449	11.449	1.000	0944 3924	SPLIT	NBR
9.450	10.450	.500	0945 5604	SPLIT	NBR
9.450	10.827	.630	19845 H1L20	LUP	XNBR
9.450	10.950	.750	0945 10634	SPLIT	NBR
9.465	10.875	.375	7231 H1L7	SS	NBR
9.465	10.875	.406	70017 H1L5	TSS	NBR
9.480	11.065	.750	13751 ALLL7	SPCL	NBR
9.480	11.065	.750	13751 H1L7	SPCL	NBR
9.500	10.500	.438	10228 H1L5	LUP	NBR
9.500	10.500	.438	15454 H1L5	LUP	NBR
9.500	10.500	.438	15454 H1L5 PTFE	LUP	N/P
9.500	10.500	.438	15454 H5L16	LUP	FKM
9.500	10.500	.438	3775 H1L20	RUP	XNBR
9.500	10.500	.438	3775 H1L5	RUP	NBR
9.500	10.500	.438	3775 H5L16	RUP	FKM
9.500	10.500	.500	17112 H1L7	H	NBR
9.500	10.500	.500	0950 5604	SPLIT	NBR
9.500	10.500	.500	0950 5604 V	SPLIT	FKM
9.500	10.500	.594	0950 3704	SPLIT	NBR
9.500	10.500	.750	0950 6512	SPLIT	NBR
9.500	10.750	.313	17556 H1L7	SS	NBR
9.500	10.750	.375	0950 3375	SPLIT	NBR
9.500	10.750	.500	0950 16364	SPLIT	NBR
9.500	10.750	.625	16560 H1L5	LUP	NBR
9.500	10.750	.625	9823 H1L5	RUP	NBR
9.500	10.750	.625	9823 H5L16	RUP	FKM
9.500	11.000	.375	0950 15734	SPLIT	NBR
9.500	11.000	.500	9878 ALLL5	RPDT	NBR
9.500	11.000	.688	10538 H1L5	LPD	NBR
9.500	11.000	.688	10538 H5L16	LPD	FKM
9.500	11.000	.688	18763 H1L5	LPD	NBR
9.500	11.000	.750	9727 H1L5	RUP	NBR
9.500	11.000	.750	9727 H5L16	RUP	FKM
9.500	11.000	.750	0950 10634	SPLIT	NBR
9.500	11.000	.750	0950 10634 V	SPLIT	FKM
9.500	11.000	.750	TMAL 11000-4848	TMAL	PTFE
9.500	11.125	.750	0950 12323	SPLIT	NBR
9.500	11.500	.625	16986 H1L5	LDS	NBR
9.500	11.500	.625	16986 H1L70	LDS	NBR
9.500	11.250	.625	16558 H1L5	LUP	NBR
9.500	11.250	.625	16558 H5L16	LUP	FKM
9.500	11.500	.750	6451 H1L5	LUP	NBR
9.500	11.500	.750	9568 H1L5	RUP	NBR
9.500	11.500	.750	0950 9742	SPLIT	NBR
9.500	11.500	.750	0950 9742 V	SPLIT	FKM
9.500	11.500	.750	9568 H5L16	RUP	FKM
9.500	11.500	.812	19103 H1L5	LPDW	NBR
9.500	11.500	.813	17855 H1L70	LUPW	NBR
9.500	11.500	.813	17855 H1L5	LUPW	NBR
9.500	11.500	.813	17855 H5L16	LUPW	FKM
9.500	11.500	1.000	8824 H1L5	LUP	NBR
9.500	11.500	1.000	8824 H5/MX5489	LUP	FKM
9.500	11.500	1.000	0950 3794	SPLIT	NBR
9.500	11.500	1.000	0950 3924	SPLIT	NBR
9.500	11.500	1.320	17382 H1L5	LPDW	NBR
9.531	10.500	.625	17461 H1L5	LUP	NBR
9.532	10.532	.500	0953 5604	SPLIT	NBR
9.563	10.563	.500	0956 5604	SPLIT	NBR
9.563	10.563	.750	0956 6512	SPLIT	NBR

See Section 4 for seal type description. For High Misalignment sizes, see Page B-86.
For FlexiSeal Listings, see Pages B-93 and B-97.

03/03/06



B

Shaft Dia.	Bore Dia.	Seal Width	Parker Part Number	Seal Type	Material
9.563	10.817	.500	0956 16364	SPLIT	NBR
9.563	11.063	.625	0956 3689	SPLIT	NBR
9.563	11.063	.750	0956 10634	SPLIT	NBR
9.563	11.563	.750	0956 9742	SPLIT	NBR
9.563	11.563	1.000	0956 3794	SPLIT	NBR
9.563	11.563	1.000	0956 3924	SPLIT	NBR
9.625	10.625	.500	0962 5604	SPLIT	NBR
9.625	10.625	.500	0962 5604 V	SPLIT	FKM
9.625	10.625	.594	0962 3704	SPLIT	NBR
9.625	10.875	.500	0962 16364	SPLIT	NBR
9.625	10.875	.625	8830 H1L5	LPD	NBR
9.625	10.875	.625	8830 H5MX5489	LPD	FKM
9.625	10.875	.875	9293 H1L5	LPD	NBR
9.625	11.250	.750	0962 12323	SPLIT	NBR
9.625	11.625	.625	18415 H1L5	LUP	NBR
9.625	11.625	1.000	12252 H1L5	LPD	NBR
9.625	11.625	1.000	0962 3924	SPLIT	NBR
9.625	12.750	1.250	15171 H1L5	LDS	NBR
9.688	11.188	.375	0968 15734	SPLIT	NBR
9.688	11.188	.750	10634 H1L5	RPD	NBR
9.688	11.188	.750	10634 H5L16	RPD	FKM
9.700	10.950	.750	16446 ALLL5	SPEC	NBR
9.750	10.750	.500	16657 H1L5	LDS	NBR
9.750	10.750	.500	18069 H1L5	LDS	NBR
9.750	10.750	.500	17642 H1L5	OLSS	NBR
9.750	10.750	.500	17642 H5L16	OLSS	FKM
9.750	10.750	.500	5604 H1L5	RUP	NBR
9.750	10.750	.500	5604 H5L16	RUP	FKM
9.750	10.750	.500	0975 10954	SPLIT	NBR
9.750	10.750	.500	0975 10954 V	SPLIT	FKM
9.750	10.750	.594	0975 3704	SPLIT	NBR
9.750	10.750	.625	15549 H1L5	STLUP	NBR
9.750	11.000	.500	0975 16364	SPLIT	NBR
9.750	11.000	.500	0975 16364 V	SPLIT	FKM
9.750	11.000	.625	11224 H1L5	LPD	NBR
9.750	11.000	.625	12465 H1L5	LPD	NBR
9.750	11.000	.625	12465 H5L16	LPD	FKM
9.750	11.000	.750	14832 H1L5	STLPD	NBR
9.750	11.250	.625	0975 3689	SPLIT	NBR
9.750	11.250	.625	0975 3689 V	SPLIT	FKM
9.750	11.250	.750	13809 H1L5	LUP	NBR
9.750	11.250	.750	13809 H5L16	LUP	FKM
9.750	11.375	.750	0975 12323	SPLIT	NBR
9.750	11.625	1.815	18158 H1L5	LPDW	NBR
9.750	11.625	1.815	18158 H5L16	LPDW	FKM
9.750	11.750	.625	0975 6663	SPLIT	NBR
9.750	11.750	.750	0975 9742	SPLIT	NBR
9.750	11.750	.750	0975 9742 V	SPLIT	FKM
9.750	11.750	1.000	16559 H1L5	LUP	NBR
9.750	11.750	1.000	3924 H1L5	RUP	NBR
9.750	11.750	1.000	0975 3794	SPLIT	NBR
9.750	13.750	1.000	0975 11205	SPLIT	NBR
9.813	10.812	.594	0981 3704	SPLIT	NBR
9.813	10.813	.500	0981 10954	SPLIT	NBR
9.813	11.063	.500	0981 16364	SPLIT	NBR
9.813	11.813	.750	0981 9742	SPLIT	NBR
9.813	11.997	.719	0981 15341	SPLIT	NBR
9.813	13.813	1.000	0981 11205	SPLIT	NBR
9.821	11.500	.625	17314 H1L5	LUP	NBR
9.821	11.500	.625	17314 H5L16	LUP	FKM
9.834	10.834	.500	0983 10954	SPLIT	NBR
9.840	11.024	.750	19872 H1L5	LUP	NBR
9.840	11.024	.750	19872 H1L5 PTFE	LUP	N/P
9.840	11.840	.750	0984 9742 V	SPLIT	FKM
9.843	11.024	.591	30214 H1L5	RUP	NBR
9.843	11.093	.375	0984 3375	SPLIT	NBR

Shaft Dia.	Bore Dia.	Seal Width	Parker Part Number	Seal Type	Material
9.843	11.417	.629	30055 H5L16	LUP	FKM
9.844	10.630	.472	15307 H5L16	P	FKM
9.875	10.875	.500	0987 10954	SPLIT	NBR
9.875	10.875	.594	0987 3704	SPLIT	NBR
9.875	11.375	.375	0987 15734	SPLIT	NBR
9.875	11.375	.625	0987 3689	SPLIT	NBR
9.875	11.500	.750	0987 12323	SPLIT	NBR
9.875	11.875	.625	0987 6663	SPLIT	NBR
9.875	11.875	.688	7340 H1L5	LUP	NBR
9.875	11.875	.750	0987 9742	SPLIT	NBR
9.875	11.875	1.000	0987 3794	SPLIT	NBR
9.875	12.060	.719	0987 15341	SPLIT	NBR
9.910	11.910	.750	0991 9742	SPLIT	NBR
9.938	10.938	.500	0993 10954	SPLIT	NBR
9.938	10.938	.750	0993 6512	SPLIT	NBR
9.938	11.188	.375	0993 16364	SPLIT	NBR
9.938	11.438	.625	0993 3689	SPLIT	NBR
9.938	11.500	.750	0993 20753	SPLIT	NBR
9.938	11.938	.625	0993 6663	SPLIT	NBR
9.938	11.938	.750	0993 9742	SPLIT	NBR
9.939	11.120	.630	0993 15713	SPLIT	NBR
9.945	11.570	.750	0994 12323	SPLIT	NBR
9.978	10.978	.500	0997 10954	SPLIT	NBR
9.990	11.990	.750	0999 9742	SPLIT	NBR
10.000	10.625	.375	13321 ALLL5	LDS	NBR
10.000	11.000	.500	1000 10954	SPLIT	NBR
10.000	11.000	.500	1000 10954 V	SPLIT	FKM
10.000	11.000	.594	3704 H1L5	RUP	NBR
10.000	11.000	.594	3704 H5L16	RUP	FKM
10.000	11.000	.750	9830 H1L5	LUP	NBR
10.000	11.000	.750	9830 H5L16	LUP	FKM
10.000	11.000	.750	1000 6512	SPLIT	NBR
10.000	11.000	.750	1000 6512 V	SPLIT	FKM
10.000	11.125	.563	16561 H1L5	LUP	NBR
10.000	11.250	.500	1000 16364	SPLIT	NBR
10.000	11.250	.562	14266 H1L5	B	NBR
10.000	11.250	.625	13686 H1L5	LDS	NBR
10.000	11.250	.625	13686 H5L16	LDS	FKM
10.000	11.250	.625	9482 H1L5	LUP	NBR
10.000	11.250	.625	9482 H5L16	LUP	FKM
10.000	11.250	.625	9482 STH5MX5489	LUP	FKM
10.000	11.250	.625	1000 4384	SPLIT	NBR
10.000	11.250	.625	1000 4384 V	SPLIT	FKM
10.000	11.250	.750	9163 H1L5	LUP	NBR
10.000	11.500	.375	1000 15734	SPLIT	NBR
10.000	11.500	.625	12529 H1L5	LUP	NBR
10.000	11.500	.625	12529 H5L16	LUP	FKM
10.000	11.500	.625	12529 MSD6228	LUP	NBR
10.000	11.500	.625	12529 STH1L5	LUP	NBR
10.000	11.500	.625	1000 3689	SPLIT	NBR
10.000	11.500	.625	1000 3689 V	SPLIT	FKM
10.000	11.500	.750	19799 H5MX5489	LUPW	FKM
10.000	11.750	.750	16562 H1L5	LUP	NBR
10.000	12.000	.625	17846 H1L5	LDS	NBR
10.000	12.000	.625	1000 6663	SPLIT	NBR
10.000	12.000	.625	1000 6663 V	SPLIT	FKM
10.000	12.000	.750	1000 15055	SPLIT	NBR
10.000	12.000	.750	1000 9742	SPLIT	NBR
10.000	12.000	.813	16365 H1L5	LUP	NBR
10.000	12.000	.813	16365 H5L16	LUP	FKM
10.000	12.000	.813	16563 H1L5	LUPW	NBR
10.000	12.000	.813	16563 H5L16	LUPW	FKM
10.000	12.000	1.000	3794 H1L5	RPD	NBR
10.000	12.000	1.000	1000 9094	SPLIT	NBR
10.000	12.000	1.000	1000 9094 V	SPLIT	FKM
10.000	12.184	.719	1000 15341	SPLIT	NBR

See Section 4 for seal type description. For High Misalignment sizes, see Page B-86. For FlexiSeal Listings, see Pages B-93 and B-97.

03/03/06



B

Shaft Dia.	Bore Dia.	Seal Width	Parker Part Number	Seal Type	Material
10.000	12.278	.600	9139 H1L5	SSW	NBR
10.000	13.250	1.166	15468 H1L5	LPDW	NBR
10.000	13.500	1.238	20460 H1L5	LUPEL	NBR
10.000	14.000	2.475	20543 H1L5	LUPEL	NBR
10.063	11.563	.625	1006 3689	SPLIT	NBR
10.063	11.688	.750	12323 H1L5	RPD	NBR
10.125	11.375	.625	1012 4384	SPLIT	NBR
10.125	11.625	.625	1012 3689	SPLIT	NBR
10.125	11.625	.625	1012 3689 V	SPLIT	FKM
10.125	11.750	.688	16564 H1L5	LUPW	NBR
10.125	12.000	.600	13687 H1L5	SSW	NBR
10.125	12.000	.750	16565 H1L5	LUPW	NBR
10.125	12.012	.500	1012 6663	SPLIT	NBR
10.125	12.125	.750	1012 15055	SPLIT	NBR
10.125	12.125	1.000	1012 9094	SPLIT	NBR
10.125	14.125	1.000	11205 ALLL5	RPD	NBR
10.188	11.188	.500	10954 H1L5	RUP	NBR
10.188	11.188	.500	10954 H5L16	RUP	FKM
10.188	11.188	.500	TMAL 11188-3232	TMAL	PTFE
10.188	11.438	.500	16364 H1L5	RUP	NBR
10.188	11.438	.500	16364 H5L16	RUP	FKM
10.188	11.438	.625	1018 11346	SPLIT	NBR
10.188	11.438	.625	1018 4384	SPLIT	NBR
10.188	11.680	.625	1018 3689	SPLIT	NBR
10.188	11.688	.375	15734 H1L5	RPD	NBR
10.188	12.188	.625	1018 6663	SPLIT	NBR
10.188	12.372	.719	15341 H1L5	RUP	NBR
10.236	11.969	.787	30101 H5L89	LUP	FKM
10.236	11.986	.563	1023 16601	SPLIT	NBR
10.236	12.202	.790	19295 H1L5	LUPW	NBR
10.242	11.742	.625	1024 3689	SPLIT	NBR
10.250	11.250	.750	6512 H1L5	RUP	NBR
10.250	11.250	.750	6512 H5L16	RUP	FKM
10.250	11.500	.375	3375 H1L5	RUP	NBR
10.250	11.500	.625	1025 4384	SPLIT	NBR
10.250	11.750	.625	1025 3689	SPLIT	NBR
10.250	11.750	.625	1025 3689 V	SPLIT	FKM
10.250	11.750	.750	16566 H1L5	LUP	NBR
10.250	11.750	.750	16566 H5L16	LUP	FKM
10.250	11.750	.750	1025 10349	SPLIT	NBR
10.250	11.750	.750	TMAL 11750-4848	TMAL	PTFE
10.250	12.000	.563	1025 16601	SPLIT	NBR
10.250	12.000	.750	16567 H1L5	LUP	NBR
10.250	12.250	.625	1025 6663	SPLIT	NBR
10.250	12.250	.750	9742 H1L5	RUP	NBR
10.250	12.250	.750	9742 H5L16	RUP	FKM
10.250	12.250	.750	9742 H5MX5489	RUP	FKM
10.250	12.250	.750	1025 15055	SPLIT	NBR
10.250	12.250	.750	1025 15055 V	SPLIT	FKM
10.250	12.250	1.000	4873 H1L5	LUP	NBR
10.250	12.250	1.000	1025 9094	SPLIT	NBR
10.313	11.812	.625	1031 3689	SPLIT	NBR
10.313	11.813	.750	1031 10349	SPLIT	NBR
10.372	12.750	1.250	1036 14111	SPLIT	NBR
10.375	11.625	.625	1037 11346	SPLIT	NBR
10.375	11.625	.625	1037 4384	SPLIT	NBR
10.375	11.875	.750	1037 10349	SPLIT	NBR
10.375	12.250	1.000	15407 H1L5	RPD	NBR
10.375	12.375	.750	1037 15055	SPLIT	NBR
10.375	12.750	1.000	15430 H1L5	STLUP	NBR
10.395	11.513	.480	17038 5066	HP	FKM
10.405	12.405	.750	1040 15055	SPLIT	NBR
10.424	11.605	.630	15713 H1L5	RPD	NBR
10.424	11.605	.630	15713 H5L16	RPD	FKM
10.433	11.417	.630	20767 H5L16	SS	FKM
10.438	11.438	.625	1043 13848	SPLIT	NBR

Shaft Dia.	Bore Dia.	Seal Width	Parker Part Number	Seal Type	Material
10.438	11.688	.625	1043 11346	SPLIT	NBR
10.438	11.688	.625	1043 11346 V	SPLIT	FKM
10.438	11.688	.625	1043 4384	SPLIT	NBR
10.438	11.925	.625	1043 3942	SPLIT	NBR
10.438	11.938	.750	1043 10349	SPLIT	NBR
10.438	12.000	.750	20753 H1L5	RUP	NBR
10.438	12.438	.750	1043 15055	SPLIT	NBR
10.438	12.438	1.000	1043 9094	SPLIT	NBR
10.454	12.065	.865	19571 H1L5	RUP	NBR
10.480	12.525	.990	13874 H1L7	SPCL	NBR
10.490	12.500	1.463	17145 H1L5	LUPW	NBR
10.495	13.600	.750	18032 H1L5	SSW	NBR
10.500	11.500	.500	1050 11276	SPLIT	NBR
10.500	11.500	.500	18723 H1L5	LUP	NBR
10.500	11.500	.625	1050 13848	SPLIT	NBR
10.500	11.750	.625	8829 H1L5	LUP	NBR
10.500	11.750	.625	8829 H1L70	LUP	NBR
10.500	11.750	.625	8829 H5L16	LUP	FKM
10.500	11.750	.625	80084 H1L5	MIST	NBR
10.500	11.750	.625	1050 11346	SPLIT	NBR
10.500	11.750	.625	1050 4384	SPLIT	NBR
10.500	11.750	.625	1050 4384 V	SPLIT	FKM
10.500	11.750	.625	1050 4673	SPLIT	NBR
10.500	11.750	.625	TMAL 11750-4040	TMAL	PTFE
10.500	11.750	.875	9289 H1L5	LUP	NBR
10.500	11.750	.875	9289 H5L16	LUP	FKM
10.500	12.000	.625	6920 H1L5	OLLUP	NBR
10.500	12.000	.625	6920 H5L16	OLLUP	FKM
10.500	12.000	.625	3689 H1L5	RUP	NBR
10.500	12.000	.625	3689 H5L16	RUP	FKM
10.500	12.000	.625	1050 3942	SPLIT	NBR
10.500	12.000	.625	1050 3942 V	SPLIT	FKM
10.500	12.000	.625	1050 5969	SPLIT	NBR
10.500	12.000	.625	TMAL 12000-4048	TMAL	PTFE
10.500	12.000	.688	16568 H1L5	LUPW	NBR
10.500	12.000	.688	16568 H5L16	LUPW	FKM
10.500	12.000	.688	16922 H1L5	LUPW	NBR
10.500	12.000	.688	16922 H5L16	LUPW	FKM
10.500	12.000	.750	17319 H1L5	LDS	NBR
10.500	12.000	.750	1050 10349	SPLIT	NBR
10.500	12.125	.750	15992 H1L5	LUP	NBR
10.500	12.250	.563	1050 16601	SPLIT	NBR
10.500	12.500	.563	16272 H1L5	SSW	NBR
10.500	12.500	.625	6663 H1L5	RUP	NBR
10.500	12.500	.625	6663 H5L16	RUP	FKM
10.500	12.500	.750	18164 H1L5	LUP	NBR
10.500	12.500	.750	18164 H5L16	LUP	FKM
10.500	12.500	.750	18164 H5MX5489	LUP	FKM
10.500	12.500	.750	19278	MP	FKM
10.500	12.500	.750	1050 15055	SPLIT	NBR
10.500	12.500	.938	1050 9934	SPLIT	NBR
10.500	12.500	1.000	17476 H1L5	LDS	NBR
10.500	12.500	1.000	14018 H5L16	LUP	FKM
10.500	12.500	1.000	3828 H1L5	LUP	NBR
10.500	12.500	1.000	1050 9094	SPLIT	NBR
10.500	12.500	1.000	17764 H1L5	ST-HP	NBR
10.500	12.500	1.000	14018 H1L5	STLUP	NBR
10.500	12.625	1.000	1050 18843	SPLIT	NBR
10.500	12.625	1.000	13318 H1L5	LPD	NBR
10.500	12.750	1.250	9347 H1L5	LPDW	NBR
10.500	14.500	1.000	14982 H1L5	LPDW	NBR
10.540	11.563	.687	10758 ALLL7	P	NBR
10.560	12.938	1.250	14111 H1L5	RPD	NBR
10.563	11.812	.625	1056 4384	SPLIT	NBR
10.620	11.500	.625	19435 H1L5	LUP	NBR
10.625	11.750	.750	17234 H1L5	LDS	NBR

See Section 4 for seal type description. For High Misalignment sizes, see Page B-86. For FlexiSeal Listings, see Pages B-93 and B-97.

03/03/06



Rotary Lip Seal Inch Sizes

10.625 to 11.250

B

Shaft Dia.	Bore Dia.	Seal Width	Parker Part Number	Seal Type	Material
10.625	11.875	.625	1062 11346	SPLIT	NBR
10.625	12.125	.625	1062 3942	SPLIT	NBR
10.625	12.125	.750	1062 10349	SPLIT	NBR
10.625	12.375	.563	1062 16601	SPLIT	NBR
10.625	12.625	.938	1062 9934	SPLIT	NBR
10.625	13.750	.660	14582 H1L5	SSW	NBR
10.642	14.688	1.000	8849 H1L5	LPD	NBR
10.642	14.688	1.000	8849 H5L16	LPD	FKM
10.688	12.438	.563	1068 16601	SPLIT	NBR
10.688	12.688	.750	15055 H1L5	RPD	NBR
10.688	12.688	.750	15055 H5L16	RPD	FKM
10.750	11.750	.500	1075 11276	SPLIT	NBR
10.750	11.750	.563	6863 H1L5	LPD	NBR
10.750	11.750	.563	6863 H5L16	LPD	FKM
10.750	11.750	.625	1075 13848	SPLIT	NBR
10.750	12.000	.625	4384 H1L5	RUP	NBR
10.750	12.000	.625	4384 H5L16	RUP	FKM
10.750	12.000	.625	1075 11346	SPLIT	NBR
10.750	12.000	.625	1075 4673	SPLIT	NBR
10.750	12.000	.625	1075 5422	SPLIT	NBR
10.750	12.125	.500	13193 H1L5	SSW	NBR
10.750	12.125	.500	13193 H1L5	SSW	NBR
10.750	12.250	.563	16569 H1L5	LUP	NBR
10.750	12.250	.563	16569 H5Mx5489	LUP	FKM
10.750	12.250	.625	1075 3942	SPLIT	NBR
10.750	12.250	.750	1075 10349	SPLIT	NBR
10.750	12.250	.750	1075 10349 V	SPLIT	FKM
10.750	12.500	.500	11651 414	DS	CR
10.750	12.500	.562	8471 H1L5	LUP	NBR
10.750	12.500	.562	8471 H5L16	LUP	FKM
10.750	12.500	.563	16083 H1L5	LDS	NBR
10.750	12.500	.563	1075 16601	SPLIT	NBR
10.750	12.500	.563	1075 16601 V	SPLIT	FKM
10.750	12.750	.562	80150 ALLL5LIFE	LIFE	NBR
10.750	12.750	.563	16570 H1L5	LUP	NBR
10.750	12.750	.563	16570 H5L16	LUP	FKM
10.750	12.750	.813	1075 3553	SPLIT	NBR
10.750	12.750	.875	1075 3723	SPLIT	NBR
10.750	12.750	.938	1075 9934	SPLIT	NBR
10.750	12.750	.938	1075 9934 V	SPLIT	FKM
10.750	12.750	1.000	18217 H1L5	LUP	NBR
10.750	12.750	1.000	18217 H5Mx5489	LUP	FKM
10.750	12.750	1.000	19654 H1L5	RPD	NBR
10.750	12.750	1.000	9094 H1L5	RUP	NBR
10.750	12.750	1.000	9094 H5L89	RUP	FKM
10.750	12.875	1.000	18843 H1L5	RUP	NBR
10.750	13.375	1.250	16530 H1L5	LDS	NBR
10.770	12.020	.625	1077 11346	SPLIT	NBR
10.778	12.813	.594	70019 H1L5	TSS	NBR
10.813	12.063	.625	1081 4673	SPLIT	NBR
10.815	12.250	.531	70018 H1L5	TSS	NBR
10.820	12.205	.630	80174 H1L5	MIST	NBR
10.827	12.402	.709	80179 H1L5	MIST	NBR
10.870	11.870	.500	1087 11276	SPLIT	NBR
10.875	11.875	.625	1087 13848	SPLIT	NBR
10.875	12.375	1.000	1087 10224	SPLIT	NBR
10.875	12.500	1.000	1087 12064	SPLIT	NBR
10.875	12.875	.813	1087 3553	SPLIT	NBR
10.875	12.875	.938	1087 9934	SPLIT	NBR
10.937	14.250	1.500	20678 H1L5	MISC	NBR
10.938	11.938	.500	1093 11276	SPLIT	NBR
10.938	11.938	.625	1093 13848	SPLIT	NBR
10.938	12.188	.625	11346 H1L5	RUP	NBR
10.938	12.188	.625	11346 H5L16	RUP	FKM
10.938	12.188	.625	11346 H5Mx5489	RUP	FKM
10.938	12.188	.625	1093 4673	SPLIT	NBR

Shaft Dia.	Bore Dia.	Seal Width	Parker Part Number	Seal Type	Material
10.938	12.319	.750	1093 10530	SPLIT	NBR
10.938	12.438	1.000	1093 10224	SPLIT	NBR
10.938	12.688	.563	16601 H1L5	RUP	NBR
10.938	12.688	.563	16601 H5L16	RUP	FKM
10.938	12.938	.875	1093 3723	SPLIT	NBR
10.938	12.938	.938	1093 9934	SPLIT	NBR
10.980	13.020	.995	14653 H1L7	MISC	NBR
11.000	12.000	.500	1100 11276	SPLIT	NBR
11.000	12.000	.594	13817 ALLL7	P	NBR
11.000	12.000	.625	7115 H1L5	LA	NBR
11.000	12.000	.625	11746 H1L5	LUP	NBR
11.000	12.000	.625	11746 H5L16	LUP	FKM
11.000	12.000	.625	1100 13848	SPLIT	NBR
11.000	12.250	.625	18828 H1L5	LDS	NBR
11.000	12.250	.625	1100 4673	SPLIT	NBR
11.000	12.250	.625	1100 4673 V	SPLIT	FKM
11.000	12.250	.625	1100 5422	SPLIT	NBR
11.000	12.250	.688	11335 H1L5	LPD	NBR
11.000	12.250	.688	11335 H5L16	LPD	FKM
11.000	12.375	.750	1100 10530	SPLIT	NBR
11.000	12.500	.625	16571 H1L5	LUP	NBR
11.000	12.500	.625	3942 H1L5	RUP	NBR
11.000	12.500	.625	3942 H5L16	RUP	FKM
11.000	12.500	.625	1100 5969	SPLIT	NBR
11.000	12.500	.625	1100 9424	SPLIT	NBR
11.000	12.500	.750	10349 H1L5	RUP	NBR
11.000	12.500	.750	10349 H5L16	RUP	FKM
11.000	12.500	1.000	1100 10224	SPLIT	NBR
11.000	12.625	1.000	1100 12064	SPLIT	NBR
11.000	13.000	.750	7180 H1L5	LUP	NBR
11.000	13.000	.750	7180 H5L16	LUP	FKM
11.000	13.000	.813	1100 3553	SPLIT	NBR
11.000	13.000	.813	1100 3553 V	SPLIT	FKM
11.000	13.000	.875	1100 3723	SPLIT	NBR
11.000	13.000	.938	1100 9934	SPLIT	NBR
11.000	13.000	1.000	1100 9599	SPLIT	NBR
11.000	13.000	1.000	1100 9599 V	SPLIT	FKM
11.000	13.000	1.000	16961 H1L5	STLUP	NBR
11.000	13.000	1.375	17333 H1L5	LPDW	NBR
11.000	13.000	1.375	17333 H5L89	LPDW	FKM
11.000	13.125	2.131	18050 H1L5	LPDW	NBR
11.000	13.125	2.131	18050 H5L16	LPDW	FKM
11.000	14.750	2.178	20510 H1L5	LUPWEL	NBR
11.006	12.875	.656	70020 H1L5	TSS	NBR
11.023	12.273	.625	1102 4673 V	SPLIT	FKM
11.024	11.614	.472	15666 H1L7	P	NBR
11.024	12.598	.787	18679 H1L5	LUP	NBR
11.024	12.598	.787	18679 H5L16	LUP	FKM
11.063	12.312	.625	1106 4673	SPLIT	NBR
11.063	13.062	.938	1106 9934	SPLIT	NBR
11.101	11.742	.375	18290 ALLL5	MCL	NBR
11.125	12.375	.625	1112 5422	SPLIT	NBR
11.125	12.500	.750	1112 10530	SPLIT	NBR
11.125	12.620	.500	9380 H1L5	RPDT	NBR
11.125	13.120	.750	9877 ALLL5	RPDT	NBR
11.125	13.125	.875	1112 3723	SPLIT	NBR
11.125	13.250	1.000	1112 9599	SPLIT	NBR
11.180	12.441	.700	19026 ALLL5	SPCL	NBR
11.188	12.188	.500	11276 H1L5	RUP	NBR
11.188	12.188	.500	11276 H5L16	RUP	FKM
11.188	12.188	.625	13848 H1L5	RUP	NBR
11.200	12.435	.750	16696 ALLL5	STDS	NBR
11.220	12.720	1.000	1122 10224	SPLIT	NBR
11.244	12.125	.312	12870 ALLL7	P	NBR
11.244	12.125	.312	12870 ALLL7	P	NBR
11.250	12.500	.500	6688 H1L5	LPD	NBR

See Section 4 for seal type description. For High Misalignment sizes, see Page B-86. For FlexiSeal Listings, see Pages B-93 and B-97.

03/03/06



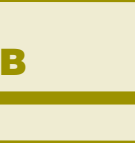

Shaft Dia.	Bore Dia.	Seal Width	Parker Part Number	Seal Type	Material
11.250	12.500	.625	4673 H1L5	RUP	NBR
11.250	12.500	.625	4673 H5L16	RUP	FKM
11.250	12.500	.625	1125 14270	SPLIT	NBR
11.250	12.500	.625	1125 5422	SPLIT	NBR
11.250	12.500	.625	1125 5422 V	SPLIT	FKM
11.250	12.500	.625	TMAL 12500-4040	TMAL	PTFE
11.250	12.750	.625	10697 H1L5	LUP	NBR
11.250	12.750	.625	5969 H1L5	RUP	NBR
11.250	12.750	.625	5969 H5L16	RUP	FKM
11.250	12.750	.625	1125 9424	SPLIT	NBR
11.250	12.750	.750	10577 H1L5	STLUP	NBR
11.250	12.750	.750	1125 8433	SPLIT	NBR
11.250	12.750	1.000	1125 10224	SPLIT	NBR
11.250	13.250	.813	3553 H1L5	RPD	NBR
11.250	13.250	.813	3553 H5L16	RPD	FKM
11.250	13.250	.875	1125 3723	SPLIT	NBR
11.250	13.250	.938	9934 H1L5	RUP	NBR
11.250	13.250	.938	9934 H5L16	RUP	FKM
11.250	13.250	1.000	16572 H1L5	LUP	NBR
11.250	13.250	1.000	16572 H5L16	LUP	FKM
11.250	13.250	1.000	16572 H5MX5489	LUP	FKM
11.250	13.250	1.000	1125 9599	SPLIT	NBR
11.250	13.250	1.000	1125 9599 V	SPLIT	FKM
11.313	12.813	.750	1131 8433	SPLIT	NBR
11.352	12.727	.750	1135 10530	SPLIT	NBR
11.375	12.625	.625	1137 14270	SPLIT	NBR
11.375	12.875	.750	1137 8433	SPLIT	NBR
11.375	12.875	.750	1137 8433 H1L20	SPLIT	XNBR
11.375	12.875	1.000	1137 10224	SPLIT	NBR
11.375	13.000	.750	12680 H1L5	LDS	NBR
11.375	13.000	.750	12680 H5L89	LDS	FKM
11.375	13.000	.750	9216 H1L3	LPD	CR
11.375	13.000	.750	9216 H1L5	LPD	NBR
11.375	13.000	.750	9216 H5L16	LPD	FKM
11.375	13.000	.750	16292 H1L3	STLUP	CR
11.375	13.000	.750	16292 H1L5	STLUP	NBR
11.375	13.375	.625	1137 16404	SPLIT	NBR
11.375	13.375	.813	16573 H1L5	LUPW	NBR
11.375	13.375	.813	16573 H5L16	LUPW	FKM
11.375	13.375	1.000	1137 9599	SPLIT	NBR
11.375	13.500	1.250	1137 9312	SPLIT	NBR
11.417	12.792	.750	1141 10530	SPLIT	NBR
11.417	12.917	.750	1141 8433	SPLIT	NBR
11.417	12.992	.591	30215 H1L5	RUP	NBR
11.435	13.746	.594	70021 H1L5	TSS	NBR
11.438	12.937	1.000	1143 10224	SPLIT	NBR
11.438	12.938	.625	1143 9424	SPLIT	NBR
11.500	12.500	.500	11528 H1L20	LUP	XNBR
11.500	12.500	.500	11528 H1L5	LUP	NBR
11.500	12.500	.500	11528 H5L16	LUP	FKM
11.500	12.500	.500	TMAL 12500-3232	TMAL	PTFE
11.500	12.500	.563	1150 16026	SPLIT	NBR
11.500	12.750	.625	9574 H1L5	LUP	NBR
11.500	12.750	.625	9574 H5MX5489	LUP	FKM
11.500	12.750	.625	5422 H1L5	RUP	NBR
11.500	12.750	.625	5422 H5L16	RUP	FKM
11.500	12.750	.625	1150 14270	SPLIT	NBR
11.500	12.875	.750	1150 10530	SPLIT	NBR
11.500	13.000	.625	1150 9424	SPLIT	NBR
11.500	13.000	.625	1150 9424 H1L50	SPLIT	NBR
11.500	13.000	.625	1150 9424 V	SPLIT	FKM
11.500	13.000	.688	16822 H1L20	LUPW	XNBR
11.500	13.000	.688	16822 H1L5	LUPW	NBR
11.500	13.000	.688	16822 H5L16	LUPW	FKM
11.500	13.000	.703	18708 H1L5	LPD	NBR
11.500	13.000	.703	18708 H5L16	LPD	FKM

Shaft Dia.	Bore Dia.	Seal Width	Parker Part Number	Seal Type	Material
11.500	13.000	.703	9019 H1L5	LUP	NBR
11.500	13.000	.703	9019 H1L70	LUP	NBR
11.500	13.000	.703	9019 H5L16	LUP	FKM
11.500	13.000	.750	1150 3676	SPLIT	NBR
11.500	13.000	.750	1150 8433	SPLIT	NBR
11.500	13.000	.750	1150 8433 V	SPLIT	FKM
11.500	13.125	.750	19587 H5L16	LUPW	FKM
11.500	13.125	.750	19587 H5L89MON	LUPW	FKM
11.500	13.125	.750	19587 H5MX5489	LUPW	FKM
11.500	13.125	1.000	12064 H1L5	RPD	NBR
11.500	13.500	.625	1150 16404	SPLIT	NBR
11.500	13.500	.875	3723 H1L5	RPD	NBR
11.500	13.500	.875	3723 H5L16	RPD	FKM
11.500	13.500	1.000	10509 H1L20	LUP	XNBR
11.500	13.500	1.000	10509 H1L5	LUP	NBR
11.500	13.500	1.000	10509 H5L16	LUP	FKM
11.500	13.500	1.000	19219 H1L5	RUPW	NBR
11.500	13.500	1.000	19219 H5MX5489	RUPW	FKM
11.500	13.500	1.000	1150 9599	SPLIT	NBR
11.500	13.500	1.000	1150 9599 V	SPLIT	FKM
11.500	13.778	.655	9027 ALLL7	SSW	NBR
11.500	13.778	.655	9027 H1L5	SSW	NBR
11.500	14.625	2.178	20594 H1L5	LUPEL	NBR
11.560	15.030	1.000	19154 H1L5	LPDW	NBR
11.563	13.063	.625	1156 9424	SPLIT	NBR
11.563	13.688	1.250	9312 H1L5	RPD	NBR
11.586	13.688	.594	70022 H1L5	TSS	NBR
11.610	13.125	.750	20696 H5L89	LUP	FKM
11.625	13.125	.688	19061 H1L5	OLLUP	NBR
11.625	13.125	.688	19061 H5L16	OLLUP	FKM
11.625	13.125	.750	1162 8433	SPLIT	NBR
11.625	13.125	1.000	10224 H1L5	RUP	NBR
11.625	13.625	1.000	1162 9599	SPLIT	NBR
11.625	15.000	1.238	19163 H1L5	LPDW	NBR
11.680	12.835	.260	16158 ALLL16	SDS	FKM
11.680	12.835	.260	16158 ALLL5	SDS	NBR
11.688	12.938	.625	14270 H1L5	RPD	NBR
11.688	13.063	.750	10530 H1L5	RUP	NBR
11.688	13.063	.750	10530 H5L16	RUP	FKM
11.688	13.188	.625	1168 9424	SPLIT	NBR
11.688	13.188	.750	1168 8433	SPLIT	NBR
11.688	13.188	.750	1168 8433 V	SPLIT	FKM
11.688	13.688	.625	1168 16404	SPLIT	NBR
11.750	12.750	.563	1175 16026	SPLIT	NBR
11.750	13.000	.625	1175 4198	SPLIT	NBR
11.750	13.250	.625	1175 9424	SPLIT	NBR
11.750	13.250	.688	16574 H1L5	LUPW	NBR
11.750	13.250	.688	16574 H5L16	LUPW	FKM
11.750	13.250	.688	80087 H1L5	MIST	NBR
11.750	13.250	.688	80087 H1L7	MIST	NBR
11.750	13.250	.750	1175 8433	SPLIT	NBR
11.750	13.750	.625	1175 16404	SPLIT	NBR
11.750	13.750	.875	1175 3818	SPLIT	NBR
11.750	13.750	.875	1175 3818 V	SPLIT	FKM
11.750	13.750	1.000	1175 5881 V	SPLIT	FKM
11.750	13.750	1.000	16575 H1L5	LUP	NBR
11.750	13.750	1.000	16575 H5L16	LUP	FKM
11.750	13.750	1.000	9599 H1L5	RUP	NBR
11.750	13.750	1.000	9599 H5L16	RUP	FKM
11.750	14.000	1.000	1175 5881	SPLIT	NBR
11.806	13.306	.625	1180 9424	SPLIT	NBR
11.813	12.813	.563	1181 16026	SPLIT	NBR
11.813	13.063	.625	1181 4198	SPLIT	NBR
11.813	13.313	.625	1181 9424	SPLIT	NBR
11.813	13.313	.750	1181 3676	SPLIT	NBR
11.813	13.813	.875	1181 3818	SPLIT	NBR

See Section 4 for seal type description. For High Misalignment sizes, see Page B-86. For FlexiSeal Listings, see Pages B-93 and B-97.

03/03/06



Rotary Lip Seal Inch Sizes

11.813 to 12.500

B

Shaft Dia.	Bore Dia.	Seal Width	Parker Part Number	Seal Type	Material
11.813	14.000	1.000	13978 H1L5	LPD	NBR
11.870	13.120	.625	1187 4198	SPLIT	NBR
11.875	12.875	.563	1187 16026	SPLIT	NBR
11.875	13.375	.625	1187 9424	SPLIT	NBR
11.875	13.375	.750	1187 3676	SPLIT	NBR
11.875	13.750	1.000	1187 19389 V	SPLIT	FKM
11.875	13.875	.875	1187 3818	SPLIT	NBR
11.938	13.438	.625	1193 9424	SPLIT	NBR
11.938	13.438	.750	1193 3676	SPLIT	NBR
11.938	13.938	.625	16404 H1L5	RUP	NBR
11.938	13.938	.750	1193 6390	SPLIT	NBR
11.938	13.938	.750	19251 H1L5	RUPW	NBR
11.938	13.938	.875	1193 3818	SPLIT	NBR
11.985	13.235	.625	1198 4198	SPLIT	NBR
11.990	13.500	.600	16401 H1L7	P	NBR
11.992	14.000	1.463	17146 H1L5	LUPW	NBR
12.000	13.000	.563	1200 16026	SPLIT	NBR
12.000	13.250	.625	1200 4198	SPLIT	NBR
12.000	13.250	.625	1200 4198 V	SPLIT	FKM
12.000	13.500	.625	15678 H1L5	LUPW	NBR
12.000	13.500	.625	15678 H5L89	LUPW	FKM
12.000	13.500	.625	1200 9424	SPLIT	NBR
12.000	13.500	.625	1200 9424 V	SPLIT	FKM
12.000	13.500	.688	17136 H1L5	LUP	NBR
12.000	13.500	.688	80004 H1L5	MIST	NBR
12.000	13.500	.750	16082 H1L5	LDS	NBR
12.000	13.500	.750	8433 H1L20	RUP	XNBR
12.000	13.500	.750	8433 H1L5	RUP	NBR
12.000	13.500	.750	8433 H5L16	RUP	FKM
12.000	13.500	.750	1200 3676	SPLIT	NBR
12.000	13.500	.750	1200 3676 V	SPLIT	FKM
12.000	13.625	.750	14267 H1L5	LPD	NBR
12.000	13.625	.750	14267 H5L16	LPD	FKM
12.000	13.750	.750	17541 H1L5	STLUP	NBR
12.000	14.000	.625	6951 H1L5	LPD	NBR
12.000	14.000	.688	14671 H1L5	STLPD	NBR
12.000	14.000	.750	1200 10890	SPLIT	NBR
12.000	14.000	.750	1200 6390	SPLIT	NBR
12.000	14.000	.813	12333 H1L5	LPD	NBR
12.000	14.000	.875	3737 H1L5	LPD	NBR
12.000	14.000	.875	1200 3818	SPLIT	NBR
12.000	14.000	1.000	9030 H1L5	LUP	NBR
12.000	14.000	1.000	9030 H5L16	LUP	FKM
12.000	14.000	1.000	1200 5881	SPLIT	NBR
12.000	14.000	1.000	1200 6390 V	SPLIT	FKM
12.000	14.000	1.125	17765 H1L5	ST	NBR
12.000	14.250	1.000	10256 H1L5	LPD	NBR
12.000	15.062	1.535	20690 H1L5	LUPWEL	NBR
12.000	15.688	1.991	20523 H1L5	LUPEL	NBR
12.000	16.625	1.125	20441 H1L5	LUPEL	NBR
12.063	14.063	1.000	1206 5881	SPLIT	NBR
12.125	13.375	.625	1212 4198	SPLIT	NBR
12.125	13.500	.625	9833 H1L5	OLLPD	NBR
12.180	13.353	.500	16274 H1	RPDEL	H1
12.180	13.353	1.500	16274 H1(Special)	RPDEL	H1
12.180	14.187	1.500	16273 H1L5	RPDEL	NBR
12.180	14.187	1.500	16273 H1L5 (Special)	RPDEL	NBR
12.188	13.188	.563	16026 H1L5	RPD	NBR
12.188	13.188	.563	16026 H5L16	RPD	FKM
12.188	13.438	.625	1218 4198	SPLIT	NBR
12.188	13.688	.625	9424 H1L5	RUP	NBR
12.188	13.688	.625	9424 H1L50	RUP	NBR
12.188	13.688	.625	9424 H5L16	RUP	FKM
12.188	13.688	.625	9424 MX 5406	RUP	NBR
12.199	13.875	.375	10789 H1L5	SS	NBR
12.199	13.875	.469	70023 H1L5	TSS	NBR

Shaft Dia.	Bore Dia.	Seal Width	Parker Part Number	Seal Type	Material
12.205	13.780	.709	20764 H5L16	LUP	FKM
12.250	13.500	.625	1225 4198	SPLIT	NBR
12.250	13.750	.625	11318 H1L5	LUP	NBR
12.250	13.750	.750	16332 H1L20	LDS	XNBR
12.250	13.750	.750	16332 H1L5	LDS	NBR
12.250	13.750	.750	16668 H1L5	LPD	NBR
12.250	13.750	.750	16668 H5L16	LPD	FKM
12.250	13.750	.750	9594 H1L20	LUP	XNBR
12.250	13.750	.750	9594 H1L5	LUP	NBR
12.250	13.750	.750	9594 H1L50	LUP	NBR
12.250	13.750	.750	9594 H5MX5489	LUP	FKM
12.250	13.750	.750	3676 H1L5	RPD	NBR
12.250	13.750	.750	3676 H5L16	RPD	FKM
12.250	13.750	.750	1225 12301	SPLIT	NBR
12.250	13.750	.750	1225 9459	SPLIT	NBR
12.250	14.000	.750	13060 H1L5	LPD	NBR
12.250	14.250	.750	80100 ALL5LIFE	MIST	NBR
12.250	14.250	.750	80100 H1L5	MIST	NBR
12.250	14.250	.750	1225 6390	SPLIT	NBR
12.250	14.250	.750	12462 H1L5	STLUP	NBR
12.250	14.250	.750	12462 H1L7	STLUP	NBR
12.250	14.250	.813	16788 H1L5	LUPW	NBR
12.250	14.250	.813	16788 H5L16	LUPW	FKM
12.250	14.250	.813	19104 H5L16	LPDW	FKM
12.250	14.250	.875	1225 3818	SPLIT	NBR
12.250	14.250	1.000	1225 5881	SPLIT	NBR
12.250	14.250	1.000	1225 5881 V	SPLIT	FKM
12.250	14.250	1.125	15355 H1L5	LDS	NBR
12.250	14.250	1.250	5891 H1L5	LPD	NBR
12.250	15.000	1.162	20580 H1L5	LUPW	NBR
12.250	17.000	1.114	19907 H1L5	LPDWEL	NBR
12.312	15.625	1.500	11661 H1L5	MISC	NBR
12.313	13.562	.625	1231 4198	SPLIT	NBR
12.313	13.813	.750	1231 9459	SPLIT	NBR
12.375	13.233	.260	19220 ALL5	SPCL	NBR
12.375	13.875	.688	16576 H1L5	LUPW	NBR
12.375	13.875	.688	16576 H5L16	LUPW	FKM
12.375	13.875	.750	1237 9459	SPLIT	NBR
12.400	13.900	.750	1240 9459	SPLIT	NBR
12.438	13.938	.750	1243 9459	SPLIT	NBR
12.450	14.076	1.000	16454 ALL5	SPEC	NBR
12.470	13.970	.750	1247 9459	SPLIT	NBR
12.500	13.375	.563	1250 17717	SPLIT	NBR
12.500	13.375	.563	1250 17717 V	SPLIT	FKM
12.500	13.500	.500	11527 H1L5	LUP	NBR
12.500	13.500	.500	11527 H5L16	LUP	FKM
12.500	13.750	.625	4198 H1L5	RUP	NBR
12.500	13.750	.625	4198 H5L16	RUP	FKM
12.500	14.000	.438	19056 H1L5	LDS	NBR
12.500	14.000	.625	14340 H1L5	LUP	NBR
12.500	14.000	.625	14340 H1L7	LUP	NBR
12.500	14.000	.625	14340 H5L16	LUP	FKM
12.500	14.000	.625	1250 6660	SPLIT	NBR
12.500	14.000	.687	80138 H1L5	STMIST	NBR
12.500	14.000	.750	11996 H1L5	LPD	NBR
12.500	14.000	.750	11996 H5L16	LPD	FKM
12.500	14.000	.750	1250 12301	SPLIT	NBR
12.500	14.000	.750	1250 12301 V	SPLIT	FKM
12.500	14.000	.750	1250 9459	SPLIT	NBR
12.500	14.000	.750	1250 9459 V	SPLIT	FKM
12.500	14.375	1.000	1250 19389 V	SPLIT	FKM
12.500	14.500	.750	19229	MP	FKM
12.500	14.500	.750	6390 H1L5	RUP	NBR
12.500	14.500	.750	6390 H5L16	RUP	FKM
12.500	14.500	.750	1250 10890	SPLIT	NBR
12.500	14.500	.750	1250 10890 V	SPLIT	FKM

See Section 4 for seal type description. For High Misalignment sizes, see Page B-86. For FlexiSeal Listings, see Pages B-93 and B-97.

03/03/06





Shaft Dia.	Bore Dia.	Seal Width	Parker Part Number	Seal Type	Material
12.500	14.500	.813	16577 H1L5	LUPW	NBR
12.500	14.500	.813	80006 H1L5	MIST	NBR
12.500	14.500	.875	16921 H1L5	LUPW	NBR
12.500	14.500	.875	16921 H5L89	LUPW	FKM
12.500	14.500	.875	3818 H1L5	RPD	NBR
12.500	14.500	.875	3818 H5L16	RPD	FKM
12.500	14.500	1.000	1250 5881	SPLIT	NBR
12.500	14.500	1.000	1250 5881 V	SPLIT	FKM
12.500	15.000	1.048	19986 H1L5	LUPW	NBR
12.500	16.513	1.031	1250 13851	SPLIT	NBR
12.590	14.173	.709	80176 H1L5	MIST	NBR
12.590	14.173	.787	30109 H5L89	LUP	FKM
12.610	14.650	1.010	13896 H1L7	SPCL	NBR
12.625	14.125	.625	1262 6660	SPLIT	NBR
12.625	14.125	.750	1262 9459	SPLIT	NBR
12.625	14.125	1.000	13061 H1L5	LPD	NBR
12.625	14.500	1.000	19389 H1L5	RPD	NBR
12.625	14.500	1.000	19389 H5L16	RPD	FKM
12.625	14.500	1.000	1262 19183 V	SPLIT	FKM
12.625	14.625	.750	1262 10890	SPLIT	NBR
12.630	14.130	.750	1263 9459	SPLIT	NBR
12.687	16.500	1.031	1268 13851	SPLIT	NBR
12.688	14.000	.625	4142 H1L5	B	NBR
12.688	16.500	1.133	17812 H1L5	LPDW	NBR
12.688	16.500	1.345	12139 H1L5	LPDW	NBR
12.750	14.250	.625	1275 6660	SPLIT	NBR
12.750	14.250	.625	1275 6660 V	SPLIT	FKM
12.750	14.250	.750	5641 H1L5	LPD	NBR
12.750	14.250	.750	5641 H5MX5489	LPD	FKM
12.750	14.250	.750	1275 12301	SPLIT	NBR
12.750	14.250	.750	1275 9459	SPLIT	NBR
12.750	14.500	.500	11650 414	DS	CR
12.750	14.750	.750	1275 10890	SPLIT	NBR
12.750	14.750	.750	1275 10890 V	SPLIT	FKM
12.750	14.750	1.000	17857 H1L5	LUP	NBR
12.750	14.750	1.000	17857 H5L16	LUP	FKM
12.750	14.750	1.000	5881 H1L5	RUP	NBR
12.750	14.750	1.000	5881 H5L16	RUP	FKM
12.770	14.270	.750	1277 12301	SPLIT	NBR
12.813	14.688	1.000	19183 H5L16	RPD	FKM
12.813	14.813	.750	1281 10890	SPLIT	NBR
12.875	14.375	.625	1287 6660	SPLIT	NBR
12.875	14.375	.750	1287 5994	SPLIT	NBR
12.875	14.750	1.000	16578 H1L5	LUP	NBR
12.875	16.688	1.031	13851 H1L5	RPD	NBR
12.938	13.813	.563	17717 H1L5	RUP	NBR
12.938	13.813	.563	17717 H5L16	RUP	FKM
12.938	14.438	.625	1293 6660	SPLIT	NBR
12.938	14.438	.625	1293 6660 V	SPLIT	FKM
12.938	14.750	1.000	18256 H1L5	LUP	NBR
12.938	14.938	.750	1293 10890	SPLIT	NBR
12.990	14.490	.625	1299 6660	SPLIT	NBR
13.000	14.250	1.000	17317 H1L5	LDS	NBR
13.000	14.500	.625	1300 6660	SPLIT	NBR
13.000	14.500	.625	1300 6660 V	SPLIT	FKM
13.000	14.500	.688	13811 H1L5	LUP	NBR
13.000	14.500	.688	13811 H5MX5489	LUP	FKM
13.000	14.500	.688	16846 H1L5	LUPW	NBR
13.000	14.500	.688	16846 H5L16	LUPW	FKM
13.000	14.500	.750	16678 H1L5	LUPW	NBR
13.000	14.500	.750	12301 H1L5	RUP	NBR
13.000	14.500	.750	12301 H5L16	RUP	FKM
13.000	14.500	.750	12301 H5MX5489	RUP	FKM
13.000	14.500	.750	9459 H1L5	RUP	NBR
13.000	14.500	.750	9459 H1MX9580	RUP	HNBR
13.000	14.500	.750	9459 H5L16	RUP	FKM

Shaft Dia.	Bore Dia.	Seal Width	Parker Part Number	Seal Type	Material
13.000	14.500	.750	1300 5994	SPLIT	NBR
13.000	14.500	1.000	1300 11587	SPLIT	NBR
13.000	14.500	1.000	3034 H1L5	LPD	NBR
13.000	14.625	.750	11170 H1L5	LUP	NBR
13.000	14.625	.750	11170 H5MX5489	LUP	FKM
13.000	15.000	.750	1300 10890	SPLIT	NBR
13.000	15.000	.813	12467 H1L5	STLPD	NBR
13.000	15.000	1.000	10093 H1L20	LUP	XNBR
13.000	15.000	1.000	10093 H1L5	LUP	NBR
13.000	15.000	1.000	10093 H5L16	LUP	FKM
13.000	15.000	1.266	20427 H1L5	LUPW	NBR
13.000	17.688	3.817	20599 H1L5 (Special)	LUP-EL	NBR
13.031	14.531	.625	1303 6660	SPLIT	NBR
13.031	14.531	.625	1303 6660 V	SPLIT	FKM
13.062	14.688	.750	20752 H1L5	RUP	NBR
13.063	14.562	.625	1306 6660	SPLIT	NBR
13.125	15.125	.750	1312 10890	SPLIT	NBR
13.125	16.375	1.650	20461 H1L5	LUPEL	NBR
13.188	14.688	.750	1318 5994	SPLIT	NBR
13.250	14.750	.625	6660 H1L20	RUP	XNBR
13.250	14.750	.625	6660 H1L5	RUP	NBR
13.250	14.750	.625	6660 H5L16	RUP	FKM
13.250	14.750	.625	1325 9856	SPLIT	NBR
13.250	14.750	.625	1325 9856 V	SPLIT	FKM
13.250	14.750	.688	19494 H1L5	LUP	NBR
13.250	14.750	.688	16579 H1L5	LUPW	NBR
13.250	14.750	.688	80008 H1L5	MIST	NBR
13.250	14.750	.750	1325 5994	SPLIT	NBR
13.250	14.875	.685	14872 H1L5	STLPD	NBR
13.250	15.250	.750	10890 H1L5	RPD	NBR
13.250	15.250	.750	10890 H5L16	RPD	FKM
13.250	15.250	.750	80116 H1L5	STMIST	NBR
13.250	15.250	.750	9880 ALLL5	RPDT	NBR
13.250	15.250	1.000	1325 9521	SPLIT	NBR
13.354	14.854	1.000	1335 11587	SPLIT	NBR
13.375	14.875	.625	1337 9856	SPLIT	NBR
13.375	14.875	1.000	1338 11587	SPLIT	NBR
13.380	15.118	.787	30113 H1L5	LUP	NBR
13.386	15.386	1.000	1338 9521	SPLIT	NBR
13.438	14.938	.625	1343 9856	SPLIT	NBR
13.500	15.000	.625	1350 9856	SPLIT	NBR
13.500	15.000	.688	80115 H1L5	STMIST	NBR
13.500	15.000	.750	5994 H1L5	RUP	NBR
13.500	15.000	.750	5994 H5L16	RUP	FKM
13.500	15.000	.750	1350 7058	SPLIT	NBR
13.500	15.000	.750	1350 7058 V	SPLIT	FKM
13.500	15.000	.750	15056 H1L5	STLUP	NBR
13.500	15.000	.875	19060 H1L5	LUPW	NBR
13.500	15.500	.750	1350 21007	SPLIT	NBR
13.500	15.500	.750	18146 H1L5	LUP	NBR
13.500	15.500	.813	10003 H1L5	LUP	NBR
13.500	15.500	.813	80086 ALLL5LIFE	MIST	NBR
13.500	15.500	.813	80086 H1L5	MIST	NBR
13.500	15.500	.875	1350 3586	SPLIT	NBR
13.500	15.500	1.000	1350 9447	SPLIT	NBR
13.500	15.500	1.000	1350 9447 V	SPLIT	FKM
13.500	15.500	1.000	1350 9521	SPLIT	NBR
13.500	15.500	1.000	1350 9521 V	SPLIT	FKM
13.500	15.750	2.145	17430 H1L5	LPDWEL	NBR
13.563	15.063	1.000	11034 ALLL5	RPD	NBR
13.563	15.063	.625	1350 9856	SPLIT	NBR
13.563	15.063	.625	1356 9856	SPLIT	NBR
13.563	15.563	1.000	1356 9521	SPLIT	NBR
13.563	15.563	1.000	1356 9521 V	SPLIT	FKM
13.610	15.500	.750	60028 H1L5	LDS	NBR
13.610	15.500	.750	60028 H1MX9508	LDS	HNBR

See Section 4 for seal type description. For High Misalignment sizes, see Page B-86.
For FlexiSeal Listings, see Pages B-93 and B-97.

03/03/06



Rotary Lip Seal Inch Sizes

13.610 to 14.500

B

Shaft Dia.	Bore Dia.	Seal Width	Parker Part Number	Seal Type	Material
13.610	15.500	.750	60028 H5L16	LDS	FKM
13.625	15.125	.500	1362 16183	SPLIT	NBR
13.625	15.125	.625	1362 9856	SPLIT	NBR
13.625	15.125	.750	1362 7058	SPLIT	NBR
13.688	15.188	.750	1368 7058	SPLIT	NBR
13.688	15.188	1.000	11587 H1L5	RUP	NBR
13.750	15.250	.500	1375 16183	SPLIT	NBR
13.750	15.250	.625	13539 H1L5	STLDS	NBR
13.750	15.250	.625	1375 9856	SPLIT	NBR
13.750	15.250	.625	1375 9856 V	SPLIT	FKM
13.750	15.250	.750	11748 H1L5	LUP	NBR
13.750	15.250	.750	11748 H5L89	LUP	FKM
13.750	15.250	.750	1375 7058	SPLIT	NBR
13.750	15.250	.750	1375 7058 V	SPLIT	FKM
13.750	15.500	.625	1375 4253	SPLIT	NBR
13.750	15.505	.750	17815 H1L5	LUP	NBR
13.750	15.750	.813	17887 H1L5	LUPW	NBR
13.750	15.750	.813	17887 H5L16	LUPW	FKM
13.750	15.750	1.000	10660 H1L5	STLPD	NBR
13.750	15.750	1.000	1375 9521	SPLIT	NBR
13.750	17.500	2.838	18238 H1L5	LPDW	NBR
13.797	15.500	.469	70024 H1L5	TSS	NBR
13.813	15.312	.625	1381 9856	SPLIT	NBR
13.813	15.313	.750	1381 7058	SPLIT	NBR
13.813	15.812	1.000	1381 9521	SPLIT	NBR
13.875	15.375	.750	1387 7058	SPLIT	NBR
13.875	15.875	.688	1387 11025	SPLIT	NBR
13.875	15.875	1.000	1387 9447	SPLIT	NBR
13.875	18.000	1.650	15290 H1L5	LPDW	NBR
13.880	15.880	1.000	1388 9447	SPLIT	NBR
13.938	15.438	.500	16183 H1L5	RUP	NBR
13.938	15.438	.625	1393 9419	SPLIT	NBR
13.938	15.438	.688	1393 11025	SPLIT	NBR
13.938	15.438	.750	1393 7058	SPLIT	NBR
13.963	15.468	.625	1396 9419 V	SPLIT	FKM
13.988	15.988	1.000	1398 9521	SPLIT	NBR
13.999	15.999	1.000	1399 9447	SPLIT	NBR
14.000	15.500	.625	9856 H1L5	RUP	NBR
14.000	15.500	.625	9856 H5L16	RUP	FKM
14.000	15.500	.625	1400 15464	SPLIT	NBR
14.000	15.500	.625	1400 15464 V	SPLIT	FKM
14.000	15.500	.625	1400 9419	SPLIT	NBR
14.000	15.500	.625	1400 9419 V	SPLIT	FKM
14.000	15.500	.688	1400 11025	SPLIT	NBR
14.000	15.500	.688	80083 H1L5	MIST	NBR
14.000	15.500	.750	15679 H1L5	LUPW	NBR
14.000	15.500	.750	1400 7058	SPLIT	NBR
14.000	15.500	.750	1400 7058 V	SPLIT	FKM
14.000	15.500	.750	TMAL 15500-4848	TMAL	PTFE
14.000	15.500	1.000	17388 H1L5	LDS	NBR
14.000	15.750	.625	1400 4253	SPLIT	NBR
14.000	15.750	.625	1400 4253 V	SPLIT	FKM
14.000	15.750	.875	10321 H1L5	STLPD	NBR
14.000	16.000	.750	21007 H1L5	RUPW	NBR
14.000	16.000	.750	1400 13204	SPLIT	NBR
14.000	16.000	.750	18549 ALLL5	SSW	NBR
14.000	16.000	.750	18549 H1L5	SSW	NBR
14.000	16.000	.813	10159 H1L5	STLPD	NBR
14.000	16.000	.875	1400 6662	SPLIT	NBR
14.000	16.000	.875	3586 H1L5	B	NBR
14.000	16.000	1.000	9521 H1L3	RUP	CR
14.000	16.000	1.000	9521 H1L5	RUP	NBR
14.000	16.000	1.000	9521 H5L16	RUP	FKM
14.000	16.000	1.000	1400 9447	SPLIT	NBR
14.000	16.000	1.000	1400 9447 V	SPLIT	FKM
14.000	16.000	1.500	1400 15576	SPLIT	NBR

Shaft Dia.	Bore Dia.	Seal Width	Parker Part Number	Seal Type	Material
14.000	16.250	1.000	20452 H1L5	RUPW	NBR
14.000	16.250	1.000	6493 H1L5	LPD	NBR
14.031	15.531	.750	1403 7058	SPLIT	NBR
14.048	15.548	.625	1404 9419	SPLIT	NBR
14.130	15.630	.625	1414 15464	SPLIT	NBR
14.130	15.875	.840	19787 H5MX9514	LUPEL	H5MX9514
14.143	15.630	.625	1414 15464 V	SPLIT	FKM
14.160	15.660	.625	1416 15464	SPLIT	NBR
14.160	15.660	.625	1416 9419	SPLIT	NBR
14.160	15.660	.750	1415 13204 V	SPLIT	FKM
14.167	15.667	.625	1417 9419	SPLIT	NBR
14.170	15.920	.625	1417 4253	SPLIT	NBR
14.170	16.172	.875	3635 H1L5	B	NBR
14.172	16.734	.844	15166 H1L5	STLPD	NBR
14.173	15.673	.625	1417 15464	SPLIT	NBR
14.173	15.748	.669	80108 H1L5	MIST	NBR
14.188	15.688	.625	1418 9419	SPLIT	NBR
14.190	15.690	.625	1419 15464	SPLIT	NBR
14.190	15.690	.625	1419 15464 V	SPLIT	FKM
14.250	15.750	.625	1425 15464	SPLIT	NBR
14.250	15.750	.625	1425 15464 V	SPLIT	FKM
14.250	15.750	.625	1425 9419	SPLIT	NBR
14.250	15.750	.688	1425 11025	SPLIT	NBR
14.250	15.750	.750	1425 12631	SPLIT	NBR
14.250	15.750	.750	17920 H1L5	LUPW	NBR
14.250	15.750	.750	7058 H1L5	RUP	NBR
14.250	15.750	.750	7058 H5MX5489	RUP	FKM
14.250	15.750	.750	1425 12631 V	SPLIT	FKM
14.250	15.750	.750	1425 13204	SPLIT	NBR
14.250	15.750	.750	1425 13204 V	SPLIT	FKM
14.250	16.000	.625	1425 4253	SPLIT	NBR
14.250	16.250	.625	11750 H1L3	LUP	CR
14.250	16.250	.625	11750 H1L5	LUP	NBR
14.250	16.250	.625	11750 H1L5 PTFE	LUP	N/P
14.250	16.250	.625	11750 H1L7	LUP	NBR
14.250	16.250	.625	11750 H5L16	LUP	FKM
14.250	16.250	.625	11750 H5MX5489	LUP	FKM
14.250	16.250	.688	20596 H1L5	LDS	NBR
14.250	16.250	1.000	9447 H1L5	RUP	NBR
14.250	16.250	1.000	9447 H5L16	RUP	FKM
14.281	15.781	.750	1428 13204	SPLIT	NBR
14.313	17.625	1.500	20617 H1L5	MISC	NBR
14.340	16.000	.688	80117 H1L5	STMIST	NBR
14.375	15.750	.531	1437 10531	SPLIT	NBR
14.375	15.875	.625	1437 9419	SPLIT	NBR
14.375	15.875	.750	1437 12631	SPLIT	NBR
14.438	15.938	.625	15464 H1L5	RUP	NBR
14.438	15.938	.625	15464 H5L16	RUP	FKM
14.438	15.938	.625	1443 9419	SPLIT	NBR
14.438	18.500	1.200	13149 H1L5	LPDW	NBR
14.462	15.962	.688	1446 11025	SPLIT	NBR
14.500	16.000	.625	1450 9419	SPLIT	NBR
14.500	16.000	.625	1450 9419 V	SPLIT	FKM
14.500	16.000	.688	17787 H1L5	LUP	NBR
14.500	16.000	.688	17787 H5L16	LUP	FKM
14.500	16.000	.688	16580 H5L16	LUPW	FKM
14.500	16.000	.688	80010 H1L5	MIST	NBR
14.500	16.000	.688	1450 11025	SPLIT	NBR
14.500	16.000	.688	1450 11025 V	SPLIT	FKM
14.500	16.000	.688	16580 H1L5	STLUP	NBR
14.500	16.000	.750	1450 12631	SPLIT	NBR
14.500	16.000	.750	1450 12631 V	SPLIT	FKM
14.500	16.000	.750	1450 13204	SPLIT	NBR
14.500	16.250	.625	17299 H1L5	LUP	NBR
14.500	16.250	.625	17299 H5L16	LUP	FKM
14.500	16.250	.625	4253 H1L5	RPD	NBR

See Section 4 for seal type description. For High Misalignment sizes, see Page B-86. For FlexiSeal Listings, see Pages B-93 and B-97.

03/03/06



B

Shaft Dia.	Bore Dia.	Seal Width	Parker Part Number	Seal Type	Material
14.500	16.250	.625	4253 H5L16	RPD	FKM
14.500	16.250	.625	1450 19554	SPLIT	NBR
14.500	16.250	.625	1450 19554 V	SPLIT	FKM
14.500	16.500	.813	80104 STH1L5	MIST	NBR
14.500	16.500	.813	80104 H5MX5489	MIST	FKM
14.500	16.500	.813	11075 H1L5	STLPD	NBR
14.500	16.500	.875	1450 6662	SPLIT	NBR
14.500	16.500	.938	14648 H1L5	STLUP	NBR
14.563	15.938	.531	1456 10531	SPLIT	NBR
14.563	16.000	.625	12104 H1L5	LUP	NBR
14.563	16.000	.625	12104 H5L89	LUP	FKM
14.563	16.063	.688	1456 11025	SPLIT	NBR
14.567	16.142	.787	30216 H1L5	RUP	NBR
14.600	16.100	.688	1460 11025	SPLIT	NBR
14.625	16.000	.531	1462 10531	SPLIT	NBR
14.625	16.125	.688	1462 11025	SPLIT	NBR
14.625	16.125	.750	13204 H1L5	RUP	NBR
14.625	16.125	.750	13204 H5L16	RUP	FKM
14.625	16.125	.750	1462 12631	SPLIT	NBR
14.688	16.188	.625	9419 H1L5	RPD	NBR
14.688	16.188	.625	9419 H5L16	RPD	FKM
14.688	16.188	.688	1468 11025	SPLIT	NBR
14.688	16.188	.750	1468 12631	SPLIT	NBR
14.688	16.688	.875	1468 6662	SPLIT	NBR
14.700	16.500	1.000	19024 ALLL5	SPEC	NBR
14.750	16.125	.531	1475 10531	SPLIT	NBR
14.750	16.250	.625	4116 H1L5	B	NBR
14.750	16.250	.688	16581 H1L5	STLUP	NBR
14.750	16.250	.688	1475 11025	SPLIT	NBR
14.750	16.250	.688	16581 H1L5	LUPW	NBR
14.750	16.250	.688	20598 H1L5	LDS	NBR
14.750	16.250	.750	1475 12631	SPLIT	NBR
14.750	16.500	.688	16947 H1L5	LUPW	NBR
14.750	16.500	.688	16947 H5L16	LUPW	FKM
14.750	16.500	1.000	9066 H1L5	STLUP	NBR
14.750	16.750	.875	1475 6662	SPLIT	NBR
14.813	16.188	.531	1481 10531	SPLIT	NBR
14.813	16.500	.749	11396 H1L5	OLLPD	NBR
14.813	16.813	.875	1481 6662	SPLIT	NBR
14.840	16.340	.750	1484 12631 V	SPLIT	FKM
14.875	16.375	.750	1487 12631	SPLIT	NBR
14.875	16.875	.875	1487 6662	SPLIT	NBR
14.938	16.437	.750	1493 12631	SPLIT	NBR
14.960	18.500	.875	1496 11950	SPLIT	NBR
15.000	16.375	.531	1500 10531	SPLIT	NBR
15.000	16.500	.625	16829 H1L5	OLLPD	NBR
15.000	16.500	.688	16582 H1L5	LUPW	NBR
15.000	16.500	.688	11025 H1L5	RUP	NBR
15.000	16.500	.688	11025 H5L16	RUP	FKM
15.000	16.500	.750	1500 12631	SPLIT	NBR
15.000	16.500	.750	1500 12631 V	SPLIT	FKM
15.000	16.500	1.000	80013 H1L5	MIST	NBR
15.000	16.750	.625	19554 H1L5	RUP	NBR
15.000	16.750	.625	19554 H5L16	RUP	FKM
15.000	17.000	.750	6334 H1L5	LUP	NBR
15.000	17.000	.750	6334 H5L16	LUP	FKM
15.000	17.000	.875	3725 H1L5	B	NBR
15.000	17.000	.875	1500 6662	SPLIT	NBR
15.000	17.000	.875	1500 6662 V	SPLIT	FKM
15.000	17.250	.750	20479 H1L5	LUPW	NBR
15.000	17.500	.938	17204 H1L7	STLUP	NBR
15.000	17.500	1.250	17205 H1L5	LDS	NBR
15.000	21.000	2.440	20470 H1L5	LUPWEL	NBR
15.125	17.125	1.000	1512 9981	SPLIT	NBR
15.250	16.625	.531	1525 10531	SPLIT	NBR
15.250	16.750	.750	10401 H1L5	LPD	NBR

Shaft Dia.	Bore Dia.	Seal Width	Parker Part Number	Seal Type	Material
15.250	16.750	.750	10401 H5L16	LPD	FKM
15.250	16.750	.750	12631 H1L5	RUP	NBR
15.250	16.750	.750	12631 H5L16	RUP	FKM
15.250	17.000	1.000	1525 9700	SPLIT	NBR
15.250	17.125	.875	1525 3736	SPLIT	NBR
15.250	17.250	.750	80014 H1L5	MIST	NBR
15.250	17.250	.875	1525 6662	SPLIT	NBR
15.250	17.250	1.000	1525 9981	SPLIT	NBR
15.250	17.250	1.125	10427 H1L5	STLPD	NBR
15.335	18.875	.875	11950 H1L5	RPD	NBR
15.350	16.720	.531	1535 17464	SPLIT	NBR
15.350	16.720	.531	1535 17464 V	SPLIT	FKM
15.352	18.108	1.000	19296 H1L5	LUPW	NBR
15.375	17.125	1.000	1537 9700	SPLIT	NBR
15.375	17.250	.875	1537 3736	SPLIT	NBR
15.375	17.375	1.000	1537 9981	SPLIT	NBR
15.438	17.188	1.000	1543 9700	SPLIT	NBR
15.500	16.875	.531	10531 H1L5	RPD	NBR
15.500	16.875	.531	10531 H5L16	RPD	FKM
15.500	17.000	.750	10516 H1L5	LUP	NBR
15.500	17.000	.750	10516 H5L16	LUP	FKM
15.500	17.250	1.000	1550 9700	SPLIT	NBR
15.500	17.500	.813	16584 H1L5	STLUP	NBR
15.500	17.500	.875	6662 H1L5	RUP	NBR
15.500	17.500	.875	6662 H5L16	RUP	FKM
15.500	17.500	.875	1550 3919	SPLIT	NBR
15.500	17.500	1.000	1550 9981	SPLIT	NBR
15.500	17.875	.813	80075 H1L5	MIST	NBR
15.500	18.000	.875	1550 3587	SPLIT	NBR
15.550	18.050	.875	1555 3587	SPLIT	NBR
15.604	16.974	.531	17464 H1L5	RUP	NBR
15.604	16.974	.531	17464 H5L89	RUP	FKM
15.610	17.525	.870	14652 H1L7	SPCL	NBR
15.625	17.375	1.000	1562 9700	SPLIT	NBR
15.625	17.500	.875	3736 H1L5	RUP	NBR
15.625	17.625	1.000	1562 9981	SPLIT	NBR
15.625	18.125	.875	1562 3587	SPLIT	NBR
15.716	17.500	.469	70026 H1L5	TSS	NBR
15.747	17.747	1.000	1574 9981	SPLIT	NBR
15.750	17.000	.625	9376 H1L5	STLPD	NBR
15.750	17.000	.625	9376 H5L16	STLPD	FKM
15.750	17.250	.688	17908 H1L5	LUPW	NBR
15.750	17.250	.688	17908 H5L16	LUPW	FKM
15.750	17.250	.688	11800 H1L5	STLPD	NBR
15.750	17.250	.750	16040 H1L7	H	NBR
15.750	17.250	.875	17363 H1L5	LDS	NBR
15.750	17.500	1.000	1575 9700	SPLIT	NBR
15.750	17.750	1.000	1575 9981	SPLIT	NBR
15.750	18.000	.750	1575 19928	SPLIT	NBR
15.750	18.250	.875	1575 3587	SPLIT	NBR
15.750	18.250	.875	1575 3587 V	SPLIT	FKM
15.750	18.500	2.131	17832 H1L5	LPDW	NBR
15.813	18.000	.875	10498 H1L5	LPDW	NBR
15.750	18.625	.875	16789 H1L5	LUPW	NBR
15.750	18.625	.875	16789 H5L16	LUPW	FKM
15.875	17.500	.688	80095 H1L5	MIST	NBR
15.875	17.875	.813	1575 13674	SPLIT	NBR
15.875	17.875	.813	1587 13674	SPLIT	NBR
15.875	17.875	.875	1575 3919	SPLIT	NBR
15.875	17.875	.875	1587 3919	SPLIT	NBR
15.930	17.930	1.000	1593 9450	SPLIT	NBR
15.938	17.688	1.000	1593 9700	SPLIT	NBR
15.938	17.938	.875	1593 3919	SPLIT	NBR
15.938	17.938	.875	1593 3919 V	SPLIT	FKM
16.000	17.250	.750	1600 19089	SPLIT	NBR
16.000	17.500	.688	80017 ALLL5	MIST	NBR

See Section 4 for seal type description. For High Misalignment sizes, see Page B-86.
For FlexiSeal Listings, see Pages B-93 and B-97.

03/03/06



Rotary Lip Seal Inch Sizes

16.000 to 17.000

B

Shaft Dia.	Bore Dia.	Seal Width	Parker Part Number	Seal Type	Material
16.000	17.500	.688	80017 H1L5	MIST	NBR
16.000	17.500	.688	16445 H1L5	STLUP	NBR
16.000	17.500	.750	12410 H1L5	LPD	NBR
16.000	17.500	.750	12410 H5L16	LPD	FKM
16.000	17.750	1.000	1600 9700	SPLIT	NBR
16.000	17.875	.500	13199 H1L5	SSW	NBR
16.000	18.000	.750	1362 ALLL5	RPDT	NBR
16.000	18.000	.813	80018 H1L5	MIST	NBR
16.000	18.000	.813	80018 STH1L5	MIST	NBR
16.000	18.000	.813	1600 13674	SPLIT	NBR
16.000	18.000	.813	1600 9624 V	SPLIT	FKM
16.000	18.000	.813	12468 H1L5	STLPD	NBR
16.000	18.000	.813	12468 H5L89	STLPD	FKM
16.000	18.000	.813	9927 H1L5	STLUP	NBR
16.000	18.000	.875	6854 H1L5	LUP	NBR
16.000	18.000	.875	6854 H5L16	LUP	FKM
16.000	18.000	.828	1600 13563	SPLIT	NBR
16.000	18.000	.875	1600 3919	SPLIT	NBR
16.000	18.000	.875	1600 3919 PS	SPLIT	NBR
16.000	18.000	.875	1600 3919 V	SPLIT	FKM
16.000	18.000	1.000	9981 H1L5	RUP	NBR
16.000	18.000	1.000	9981 H5L16	RUP	FKM
16.000	18.000	1.000	1600 9450	SPLIT	NBR
16.000	18.000	1.000	1600 9624	SPLIT	NBR
16.000	18.000	1.500	1600 15576	SPLIT	NBR
16.000	18.125	.875	16810 H1L5	LUPW	NBR
16.000	18.125	.875	16810 H5L16	LUPW	FKM
16.000	18.250	.750	19928 H1L5	RUP	NBR
16.000	18.500	.875	1600 3587	SPLIT	NBR
16.000	19.000	1.870	16891 H1L5	LUPWE	NBR
16.000	19.000	1.870	16891 H5MX5489	LUPW-EL	FKM
16.000	20.000	1.000	10876 ALLL5	RPD	NBR
16.000	20.500	1.000	12248 H1L5	LPDW	NBR
16.063	18.063	.875	1606 3919	SPLIT	NBR
16.125	17.625	.625	1612 6286	SPLIT	NBR
16.125	17.625	.625	1612 6286 V	SPLIT	FKM
16.125	18.125	.875	1612 3919	SPLIT	NBR
16.130	17.643	.625	1614 6286	SPLIT	NBR
16.188	18.188	.875	1618 3919	SPLIT	NBR
16.250	17.375	.500	1625 20680	SPLIT	NBR
16.250	17.375	.500	1625 20680 V	SPLIT	FKM
16.250	17.750	.625	15473 H1L5	STLUP	NBR
16.250	17.750	.625	1625 6286	SPLIT	NBR
16.250	17.750	.625	1625 6286 V	SPLIT	FKM
16.250	17.750	1.281	14063 H1L5	LDS	NBR
16.250	18.000	.750	19970 H1L5	LUP	NBR
16.250	18.000	1.000	10698 H1L5	LPD	NBR
16.250	18.000	1.000	9700 H1L5	RPD	NBR
16.250	18.250	.813	1625 13674	SPLIT	NBR
16.250	18.250	.828	13563 H1L5	RPD	NBR
16.250	18.250	.875	1625 3919	SPLIT	NBR
16.250	18.250	1.000	1625 9450	SPLIT	NBR
16.250	18.250	1.000	1625 9450 V	SPLIT	FKM
16.250	18.250	1.500	15576 H1L5	RPD	NBR
16.260	18.260	.813	1626 9624	SPLIT	NBR
16.313	20.000	1.000	17332 H1L5	LUP	NBR
16.317	17.317	.750	18162 H1L5	OLLPD	NBR
16.349	18.453	.728	17517 H1L3	SSW	CR
16.349	18.453	.728	17517 H1L5	SSW	NBR
16.375	18.375	.875	1637 3919	SPLIT	NBR
16.375	18.375	1.000	1637 9450	SPLIT	NBR
16.500	17.750	.750	12138 H1L5	LUP	NBR
16.500	17.750	.750	12138 H1L50	LUP	NBR
16.500	17.750	.750	12138 H5L16	LUP	FKM
16.500	17.750	.750	1650 19089	SPLIT	NBR
16.500	17.750	.750	1650 19089 V	SPLIT	FKM

Shaft Dia.	Bore Dia.	Seal Width	Parker Part Number	Seal Type	Material
16.500	18.000	.625	1650 6286	SPLIT	NBR
16.500	18.000	.625	1650 6286 V	SPLIT	FKM
16.500	18.000	.750	19937 H1L5	OLLUP	NBR
16.500	18.000	.750	12507 H1L5	STLPD	NBR
16.500	18.246	.750	1650 6811	SPLIT	NBR
16.500	18.500	.813	1650 13674	SPLIT	NBR
16.500	18.500	.813	80139 H1L5	STMIST	NBR
16.500	18.500	.875	1650 3919	SPLIT	NBR
16.500	18.500	1.000	12538 H1L5	LPD	NBR
16.500	18.500	1.000	12538 H5L16	LPD	FKM
16.500	18.500	1.000	1650 9450	SPLIT	NBR
16.500	19.000	.875	3587 H1L5	RPD	NBR
16.500	19.000	.875	3587 H5L16	RPD	FKM
16.500	19.000	.875	3587-S H1L5	RPD	NBR
16.500	19.000	1.125	1650 18137	SPLIT	NBR
16.535	18.110	.787	30211 H1L5	RUP	NBR
16.560	18.560	1.000	1656 9450	SPLIT	NBR
16.600	18.600	1.000	1660 9450	SPLIT	NBR
16.625	18.375	.750	1663 6811	SPLIT	NBR
16.625	18.625	.813	1662 9624	SPLIT	NBR
16.625	18.625	.813	1662 9624 V	SPLIT	FKM
16.625	18.625	1.000	1662 9450	SPLIT	NBR
16.750	18.000	.750	19089 H1L5	RUP	NBR
16.750	18.000	.750	19089 H1MX9580	RUP	HNBR
16.750	18.000	.750	19089 H5L16	RUP	FKM
16.750	18.250	.625	1675 6286	SPLIT	NBR
16.750	18.250	.750	13371 H1L5	LPD	NBR
16.750	18.500	.750	1675 6811	SPLIT	NBR
16.750	18.750	.750	1675 6661	SPLIT	NBR
16.750	18.750	.813	1675 9624	SPLIT	NBR
16.750	18.750	.875	1675 3919	SPLIT	NBR
16.750	18.750	1.000	1675 9450	SPLIT	NBR
16.750	19.250	1.125	18137 H1L5	RUPW	NBR
16.750	20.180	2.123	20499 H1L5	LUPWEL	NBR
16.750	20.188	3.059	20589 H1L5	LUP-EL	NBR
16.860	18.860	1.000	1686 9450	SPLIT	NBR
16.875	18.750	.563	17240 H1L5	SSW	NBR
16.875	18.875	1.150	19788 H5MX5489	LPDW	FKM
16.875	18.875	1.150	19788 H5MX9514	LPDW	H5MX9514
16.900	18.400	.625	1690 6286	SPLIT	NBR
16.920	18.920	1.000	1692 9450	SPLIT	NBR
16.938	18.937	1.000	1693 9450	SPLIT	NBR
17.000	18.250	.625	10429 H1L5	LUP	NBR
17.000	18.250	.625	17962 H1L5	OLLUP	NBR
17.000	18.500	.500	19310 H5L16	LUP	FKM
17.000	18.500	.625	1700 6286	SPLIT	NBR
17.000	18.500	.625	1700 6286 V	SPLIT	FKM
17.000	18.500	.688	12509 H1L5	STLPD	NBR
17.000	18.500	.688	80022 H1L5	MIST	NBR
17.000	18.500	.750	15649 H1L7	H	NBR
17.000	18.500	.750	1700 9554	SPLIT	NBR
17.000	18.500	.875	17919 H1L5	LUPW	NBR
17.000	18.500	1.281	13590 H1L5	STLDS	NBR
17.000	18.750	.750	1700 6811	SPLIT	NBR
17.000	19.000	.750	1700 6661	SPLIT	NBR
17.000	19.000	.750	1700 6661 V	SPLIT	FKM
17.000	19.000	.813	16873 H1L5	LUPW	NBR
17.000	19.000	.813	16873 H5L16	LUPW	FKM
17.000	19.000	.813	17040 H1L5	LUPW	NBR
17.000	19.000	.813	17040 H5L16	LUPW	FKM
17.000	19.000	.813	80080 H1L5	MIST	NBR
17.000	19.000	.813	13674 H1L5	R	NBR
17.000	19.000	.813	13674 H5L16	R	FKM
17.000	19.000	.813	1700 9624	SPLIT	NBR
17.000	19.000	.875	3919 H1L5	RUP	NBR
17.000	19.000	.875	3919 H5L16	RUP	FKM

See Section 4 for seal type description. For High Misalignment sizes, see Page B-86. For FlexiSeal Listings, see Pages B-93 and B-97.

03/03/06



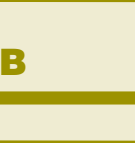

Shaft Dia.	Bore Dia.	Seal Width	Parker Part Number	Seal Type	Material
17.000	19.000	.969	9222 H1L5	STLPD	NBR
17.000	19.000	1.000	1700 9450	SPLIT	NBR
17.000	19.500	.875	17791 H1L5	LUPW	NBR
17.000	21.500	2.239	17436 H1L5	LPDW	NBR
17.063	18.813	.750	1706 6811	SPLIT	NBR
17.125	18.250	.500	20680 H1L5	RUP	NBR
17.125	18.625	.750	1712 9554	SPLIT	NBR
17.125	19.125	.750	1712 6661	SPLIT	NBR
17.188	18.563	.688	9533 H1L5	LPD	NBR
17.250	18.625	.689	10980 H1L7	P	NBR
17.250	18.750	.625	6286 H1L5	RUP	NBR
17.250	18.750	.625	6286 H5L16	RUP	FKM
17.250	18.750	.750	12629 H1L5	STLPD	NBR
17.250	18.750	.750	1725 9554	SPLIT	NBR
17.250	19.250	.750	1725 6661	SPLIT	NBR
17.250	19.250	.813	1725 9624	SPLIT	NBR
17.250	19.250	.875	3632 H1L5	OLLUP	NBR
17.250	19.250	1.000	9450 H1L5	RPD	NBR
17.250	19.250	1.000	9450 H5L16	RPD	FKM
17.313	19.063	.750	1731 6811	SPLIT	NBR
17.319	19.069	.750	1732 6811	SPLIT	NBR
17.320	18.503	.787	19876 H5L16	LUP	FKM
17.323	19.685	.984	80142 H1L5	MIST	NBR
17.375	19.375	.813	1737 9624	SPLIT	NBR
17.409	19.409	.813	1740 9624	SPLIT	NBR
17.416	19.416	.813	1741 9624	SPLIT	NBR
17.500	19.000	.625	7203 H1L5	STLPD	NBR
17.500	19.000	.750	1750 15513	SPLIT	NBR
17.500	19.000	.750	1750 9554	SPLIT	NBR
17.500	19.000	.750	1750 9554 V	SPLIT	FKM
17.500	19.500	.688	16178 H1L5	STLUP	NBR
17.500	19.500	.750	1750 3413	SPLIT	NBR
17.500	19.500	.750	1750 6661	SPLIT	NBR
17.500	19.500	.813	1750 9624	SPLIT	NBR
17.625	19.625	.750	1762 6661	SPLIT	NBR
17.629	19.375	.750	6811 H1L5	RUP	NBR
17.629	19.375	.750	6811 H5L16	RUP	FKM
17.688	20.688	1.500	1768 7157	SPLIT	NBR
17.750	19.250	.750	1775 9554	SPLIT	NBR
17.750	19.750	.750	1775 3413	SPLIT	NBR
17.750	19.750	.750	1775 6661	SPLIT	NBR
17.750	19.750	.813	9624 H1L5	RPD	NBR
17.750	19.750	.813	9624 H5L16	RPD	FKM
17.750	19.750	.813	1775 6795	SPLIT	NBR
17.750	19.750	1.000	1775 14371	SPLIT	NBR
17.875	19.137	.930	20595 H1L20	LDS	XNBR
17.875	19.500	.750	80096 H1L5	MIST	NBR
17.875	19.500	.750	19302 H1L5	STLUP	NBR
17.875	19.875	.750	1787 3413	SPLIT	NBR
17.938	19.438	.750	1793 9554	SPLIT	NBR
17.999	19.499	.750	1799 9554	SPLIT	NBR
18.000	19.500	.750	11202 H1L5	STLPD	NBR
18.000	19.500	.750	1800 9554	SPLIT	NBR
18.000	19.750	.938	13457 STH1L5	STLPD	NBR
18.000	19.875	.938	1800 40020	SPLIT	NBR
18.000	19.875	.938	1800 40020 V	SPLIT	FKM
18.000	20.000	.750	6661 H1L5	RPD	NBR
18.000	20.000	.750	6661 H5L16	RPD	FKM
18.000	20.000	.750	1800 3413	SPLIT	NBR
18.000	20.000	.750	1800 3413 V	SPLIT	FKM
18.000	20.000	.813	1800 6795	SPLIT	NBR
18.000	20.000	.813	1800 6795 V	SPLIT	FKM
18.000	20.000	.813	1800 15466	SPLIT	NBR
18.000	20.000	.875	16876 H1L5	LUPW	NBR
18.000	20.000	.875	16876 H5L16	LUPW	FKM
18.000	20.000	.875	16089 H1L5	STLUP	NBR

Shaft Dia.	Bore Dia.	Seal Width	Parker Part Number	Seal Type	Material
18.000	20.000	1.000	10425 H1L3	LPD	CR
18.000	20.000	1.000	10425 H1L5	LPD	NBR
18.000	20.000	1.000	10425 H5L16	LPD	FKM
18.000	20.000	1.000	1800 14371	SPLIT	NBR
18.000	21.000	.750	1800 19987	SPLIT	NBR
18.000	21.000	1.500	17131 H1L5	LUP	NBR
18.000	21.000	1.500	1800 7157	SPLIT	NBR
18.000	21.000	2.000	17326 H1L5	RPDEL	NBR
18.000	22.500	2.090	15091 H1L5	LPDW	NBR
18.060	22.070	1.000	1806 10536	SPLIT	NBR
18.110	19.685	.787	30130 H1L5	LUP	NBR
18.110	20.110	.750	1811 3413	RPD	NBR
18.110	20.110	.813	1811 6795	SPLIT	NBR
18.125	20.125	1.000	1812 14371	SPLIT	NBR
18.250	19.750	.750	9554 H1L5	RPD	NBR
18.250	19.750	.750	9554 H5L16	RPD	FKM
18.250	19.750	.750	1825 15513	SPLIT	NBR
18.250	19.750	.750	1825 15513 V	SPLIT	FKM
18.250	20.125	.938	40020 H1L5	RUP	NBR
18.250	20.125	.938	40020 H5L16	RUP	FKM
18.250	20.250	.750	1825 17703	SPLIT	NBR
18.250	20.250	.750	1825 3413	SPLIT	NBR
18.250	20.250	.813	15466 H1L5	RUP	NBR
18.250	20.250	.813	1825 6795	SPLIT	NBR
18.250	21.250	1.500	7157 H1L5	RPD	NBR
18.250	21.250	2.063	17268 H1L5 (Special)	RPDEL	NBR
18.375	19.875	.688	15149 H1L5	STLPD	NBR
18.375	19.938	.625	10912 H1L5	STLPD	NBR
18.375	20.375	.813	1837 6795	SPLIT	NBR
18.438	20.430	.813	1843 6795	SPLIT	NBR
18.438	20.438	1.000	1843 14371	SPLIT	NBR
18.500	19.500	.500	20750 H1L5	RUP	NBR
18.500	20.000	.750	18690 H1L5	LUP	NBR
18.500	20.000	.750	18690 H5L16	LUP	FKM
18.500	20.000	.750	19796 H1L5	LUPW	NBR
18.500	20.000	.750	19796 H5L16	LUPW	FKM
18.500	20.000	.750	15513 H1L5	RPD	NBR
18.500	20.000	.750	15513 H5L16	RPD	FKM
18.500	20.500	.750	3413 H1L5	RPD	NBR
18.500	20.500	.750	3413 H5L16	RPD	FKM
18.500	20.500	.813	1850 6795 V	SPLIT	FKM
18.500	20.500	.813	1850 6795 V	SPLIT	FKM
18.500	20.500	.813	1850 6795	SPLIT	NBR
18.500	20.500	.813	10575 H1L5	STLPD	NBR
18.500	20.500	.813	10575 H5MX5489	STLPD	FKM
18.500	20.500	.875	16981 H1L20	LUPW	XNBR
18.500	20.500	.875	16981 H1L5	LUPW	NBR
18.500	20.500	.875	16981 H5L16	LUPW	FKM
18.500	20.500	.875	80028 H1L5	MIST	NBR
18.500	20.500	.875	16937 H1L5	STLDS	NBR
18.500	20.500	1.000	1850 14371	SPLIT	NBR
18.500	23.000	1.250	17485 H1L5	STLUP	NBR
18.500	23.000	2.338	18041 H1L5	LPDW	NBR
18.504	20.472	.787	19641 H1L5	LUP	NBR
18.515	20.515	.813	1851 6795	SPLIT	NBR
18.625	20.625	.813	1862 6795	SPLIT	NBR
18.750	20.750	.813	6795 H1L5	RPD	NBR
18.750	20.750	.813	6795 H5L16	RPD	FKM
18.750	20.750	1.000	1875 14371	SPLIT	NBR
18.850	22.150	.750	20660 H1L5	LUPEL	NBR
18.866	20.866	1.000	1886 14371	SPLIT	NBR
18.875	20.625	1.000	1887 9446	SPLIT	NBR
18.875	20.875	.875	1887 3630	SPLIT	NBR
18.875	20.875	1.000	1887 14371	SPLIT	NBR
18.890	20.472	.787	30132 H1L5	LUP	NBR
18.897	20.472	.787	19588 H1L5	LUP	NBR

See Section 4 for seal type description. For High Misalignment sizes, see Page B-86. For FlexiSeal Listings, see Pages B-93 and B-97.

03/03/06



Rotary Lip Seal Inch Sizes

18.898 to 21.000

B

Shaft Dia.	Bore Dia.	Seal Width	Parker Part Number	Seal Type	Material
18.898	20.866	.709	80182 H1L5	MIST	NBR
18.955	20.205	1.000	1895 9577	SPLIT	NBR
19.000	20.500	.750	80103 ALLL20LIF	MIST	XNBR
19.000	20.500	.750	80103 ALLL5	MIST	NBR
19.000	20.500	.750	80103 H1L5	MIST	NBR
19.000	20.750	.750	1900 17703	SPLIT	NBR
19.000	20.500	.750	6855 H1L5	STLPD	NBR
19.000	20.500	.750	6855 H5L16	STLPD	FKM
19.000	20.750	1.000	1900 3791	SPLIT	NBR
19.000	20.750	1.000	1900 9446	SPLIT	NBR
19.000	21.000	.750	16835 H1L5	LUPW	NBR
19.000	21.000	.750	16835 H5L16	LUPW	FKM
19.000	21.000	.875	14076 H1L5	LPD	NBR
19.000	21.000	.875	14076 H5MX5489	LPD	FKM
19.000	21.000	.875	1900 3630	SPLIT	NBR
19.000	21.000	.875	80033 H1L5	MIST	NBR
19.000	21.000	1.000	1900 14371	SPLIT	NBR
19.000	21.000	1.000	1900 3805	SPLIT	NBR
19.000	21.000	1.000	1900 3805 V	SPLIT	FKM
19.000	21.250	1.000	1900 9577	SPLIT	NBR
19.000	22.000	.750	19987 H1L5	LUP	NBR
19.063	21.063	1.000	1906 3805	SPLIT	NBR
19.125	21.125	1.000	1912 3805	SPLIT	NBR
19.188	20.938	.625	1918 3791	SPLIT	NBR
19.188	20.938	1.000	1918 9446	SPLIT	NBR
19.219	20.750	.875	20697 5066 304	HP	FKM
19.250	21.000	.625	1925 3791	SPLIT	NBR
19.250	21.000	1.000	1925 9446	SPLIT	NBR
19.250	21.250	.750	17703 H1L5	RUPW	NBR
19.250	21.250	1.000	14371 H1L5	RPD	NBR
19.250	21.250	1.000	1925 3805	SPLIT	NBR
19.250	21.500	1.000	1925 9577	SPLIT	NBR
19.291	20.866	.787	30218 H5L16	STLUP	FKM
19.291	21.259	.866	80131 STH1L5	MIST	NBR
19.375	21.125	.625	1937 3791	SPLIT	NBR
19.375	21.125	.625	1937 9446	SPLIT	NBR
19.500	21.250	.625	1950 3791	SPLIT	NBR
19.500	21.250	1.000	1950 9446	SPLIT	NBR
19.500	21.500	.750	80032 H1L5	MIST	NBR
19.500	21.500	.875	16380 H1L5	LUPW	NBR
19.500	21.500	.875	16380 H1L70	LUPW	NBR
19.500	21.500	.875	1950 3630	SPLIT	NBR
19.500	21.500	1.000	3805 H1L5	RPD	NBR
19.500	21.500	1.000	3805 H5L16	RPD	FKM
19.500	21.500	1.000	1950 3804	SPLIT	NBR
19.500	21.500	1.000	9711 H1L5	STLPD	NBR
19.500	21.625	1.000	1950 9785	SPLIT	NBR
19.500	21.750	1.000	1950 9577	SPLIT	NBR
19.500	22.750	1.000	18197 H1L20	LUPW	XNBR
19.500	22.750	1.000	18197 H1L5	LUPW	NBR
19.563	21.563	.875	1956 3630	SPLIT	NBR
19.625	21.625	.875	1962 3630	SPLIT	NBR
19.630	21.630	.875	1963 3630	SPLIT	NBR
19.685	21.654	.866	30212 H1L5	LUP	NBR
19.688	21.688	.875	1968 3630	SPLIT	NBR
19.688	21.813	1.000	1968 9785	SPLIT	NBR
19.750	20.750	1.000	15202 ALLL5	SPCL	NBR
19.750	21.500	.813	1975 10312	SPLIT	NBR
19.750	21.500	1.000	18070 H1L5	RUPW	NBR
19.750	21.500	1.000	9446 H1L5	RUP	NBR
19.750	21.750	.625	1975 6659	SPLIT	NBR
19.750	21.750	.875	1975 3630	SPLIT	NBR
19.750	21.750	.875	80034 H1L5	MIST	NBR
19.750	21.875	1.000	1975 9785	SPLIT	NBR
19.750	22.000	1.000	9577 H1L5	RPD	NBR
19.938	21.688	.625	3791 H1L5	RPD	NBR

Shaft Dia.	Bore Dia.	Seal Width	Parker Part Number	Seal Type	Material
19.960	21.960	.875	1996 3630	SPLIT	NBR
19.970	21.970	.875	1997 3630	SPLIT	NBR
20.000	21.500	.625	2000 6714	SPLIT	NBR
20.000	21.500	.750	11409 H1L5	LPD	NBR
20.000	21.500	.750	11409 H5L16	LPD	FKM
20.000	21.500	.750	6856 H1L5	STLPD	NBR
20.000	21.502	.625	2000 7086	SPLIT	NBR
20.000	21.750	.813	2000 10312	SPLIT	NBR
20.000	22.000	.625	10664 H1L5	LUP	NBR
20.000	22.000	.625	10664 H1L7	LUP	NBR
20.000	22.000	.625	10664 H5L16	LUP	FKM
20.000	22.000	.625	2000 6659	SPLIT	NBR
20.000	22.000	.813	2000 7085	SPLIT	NBR
20.000	22.000	.875	80035 H1L5	MIST	NBR
20.000	22.000	.875	2000 3630	SPLIT	NBR
20.000	22.000	.875	2000 3630 V	SPLIT	FKM
20.000	22.000	1.000	9150 H1L5	LUP	NBR
20.000	22.125	1.000	2000 9785	SPLIT	NBR
20.000	22.125	1.000	2000 9785 V	SPLIT	FKM
20.000	23.188	2.338	20560 H1L5	LUPEL	NBR
20.000	24.000	1.000	10536 ALLL5	SPLIT	NBR
20.125	22.125	.875	2012 3630	SPLIT	NBR
20.143	22.250	.750	9941 H1L5	STLPD	NBR
20.250	22.250	.625	2025 6659	SPLIT	NBR
20.250	22.250	.875	9916 H1L5	LPD	NBR
20.250	22.250	.875	2025 3630	SPLIT	NBR
20.250	22.250	1.000	2025 3804	SPLIT	NBR
20.250	22.375	1.000	9785 H1L5	RPD	NBR
20.470	22.441	.787	30000 H1L5	LUP	NBR
20.500	21.500	.500	19147 H1L5	OLLUP	NBR
20.500	22.000	.625	2050 6714	SPLIT	NBR
20.500	22.000	.750	17759 H1L5	OLSS	NBR
20.500	22.500	.625	2050 6659	SPLIT	NBR
20.500	22.500	.813	2050 7085	SPLIT	NBR
20.500	22.500	.875	80036 H1L5	MIST	NBR
20.500	22.500	.875	80036 STH1L5	MIST	NBR
20.500	22.500	.875	2050 3630	SPLIT	NBR
20.500	22.500	.875	10218 H1L5	STLUP	NBR
20.500	22.500	1.000	3804 H1L5	B	NBR
20.625	22.125	.625	2062 6714	SPLIT	NBR
20.625	22.125	.625	2062 7086	SPLIT	NBR
20.625	22.625	1.000	12846 H1L5	LPD	NBR
20.625	22.625	1.000	12846 H5L16	LPD	FKM
20.750	22.000	.625	80136 H1L5	MIST	NBR
20.750	22.250	.625	2075 6714	SPLIT	NBR
20.750	22.500	.813	2075 10312	SPLIT	NBR
20.750	22.750	.625	2075 6659	SPLIT	NBR
20.750	22.750	.813	2075 7085	SPLIT	NBR
20.750	22.750	.875	9802 H1L5	LUP	NBR
20.750	22.750	.875	3630 H1L5	RPD	NBR
20.750	22.750	.875	3630 H5L16	RPD	FKM
20.750	22.750	1.000	80037 H1L5	MIST	NBR
20.750	22.750	1.000	2075 3839	SPLIT	NBR
20.750	23.000	1.000	2075 14946	SPLIT	NBR
20.866	22.835	.787	30008 H5L16	LUP	FKM
20.875	22.375	.625	2087 6714	SPLIT	NBR
20.875	22.875	.812	17384 H1L5	SPCL	NBR
20.938	22.938	.813	2093 7085	SPLIT	NBR
20.942	22.442	.625	2094 6714	SPLIT	NBR
21.000	22.500	.625	2100 6714	SPLIT	NBR
21.000	22.500	.625	2100 7086	SPLIT	NBR
21.000	22.500	.750	14655 H1L5	STLUP	NBR
21.000	22.500	.750	14655 H5L16	STLUP	FKM
21.000	22.500	.750	14655 H5MX5489	STLUP	FKM
21.000	22.750	.813	2100 10312	SPLIT	NBR
21.000	23.000	.625	6659 H1L5	R	NBR

See Section 4 for seal type description. For High Misalignment sizes, see Page B-86. For FlexiSeal Listings, see Pages B-93 and B-97.

03/03/06



B-80

Parker Hannifin Corporation

EPS Division

Toll Free: (800) 233-3900

www.parkerseals.com

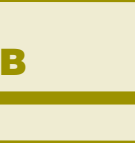

Shaft Dia.	Bore Dia.	Seal Width	Parker Part Number	Seal Type	Material
21.000	23.000	.625	6659 H5L16	R	FKM
21.000	23.000	.625	2100 3649	SPLIT	NBR
21.000	23.000	.750	20421 H1L5	RUPW	NBR
21.000	23.000	.750	80038 H1L5	MIST	NBR
21.000	23.000	.813	2100 7085	SPLIT	NBR
21.000	23.000	.813	2100 7085 V	SPLIT	FKM
21.000	23.000	.875	16827 H1L5	STLUP	NBR
21.000	23.000	.875	16827 H5L16	STLUP	FKM
21.000	23.000	.875	7008 H1L5	STLPD	NBR
21.000	23.000	1.000	2100 3839	SPLIT	NBR
21.000	24.000	1.750	2100 17327	SPLIT	NBR
21.125	22.625	.625	2112 6714	SPLIT	NBR
21.125	23.125	.813	2112 7085	SPLIT	NBR
21.250	22.750	.500	17328 H1L5	SPC	NBR
21.250	23.250	.625	2125 3649	SPLIT	NBR
21.250	23.250	.813	2125 7085	SPLIT	NBR
21.250	23.250	1.000	2125 3839	SPLIT	NBR
21.250	24.250	1.000	2125 16354	SPLIT	NBR
21.250	24.250	1.750	17327 H1L5	RPD	NBR
21.260	22.760	.625	2126 6714	SPLIT	NBR
21.260	23.228	.890	80180 H1L5	MIST	NBR
21.438	23.188	.750	13780 H1L5	STLPD	NBR
21.500	23.000	.625	2150 6714	SPLIT	NBR
21.500	23.000	.625	2150 7086	SPLIT	NBR
21.500	23.250	.813	2150 10312	SPLIT	NBR
21.500	23.500	.625	3649 H1L5	RPD	NBR
21.500	23.500	.813	2150 7085	SPLIT	NBR
21.500	23.500	1.000	12463 H1L5	LPD	NBR
21.500	23.500	1.000	2150 3839	SPLIT	NBR
21.500	24.500	1.000	16354 H1L5	RUP	NBR
21.575	23.543	.866	80130 H1L5	MIST	NBR
21.625	23.125	.625	2162 7086	SPLIT	NBR
21.625	23.625	.813	2162 7085	SPLIT	NBR
21.625	23.625	.875	6990 H1L5	LPD	NBR
21.750	23.250	.625	2175 7086	SPLIT	NBR
21.750	23.250	.625	6714 H1L5	RPD	NBR
21.750	23.500	.813	2175 10312	SPLIT	NBR
21.750	23.750	.813	2175 7085	SPLIT	NBR
21.750	23.750	.875	80145 H1L5	STMIST	NBR
21.750	24.000	1.000	2175 14946	SPLIT	NBR
21.813	23.813	.813	2181 7085	SPLIT	NBR
21.813	23.813	.813	2181 6847	SPLIT	NBR
21.845	23.845	.813	2183 7085	SPLIT	NBR
22.000	23.500	.375	80089 H1L5	MIST	NBR
22.000	23.500	.625	2200 7086	SPLIT	NBR
22.000	23.500	.750	14532 H1L5	LUP	NBR
22.000	23.500	.750	14532 H1L50	LUP	NBR
22.000	23.500	.750	14532 H5L16	LUP	FKM
22.000	23.750	.813	10312 H1L5	RPD	NBR
22.000	23.750	.813	10312 H5L16	RPD	FKM
22.000	24.000	.813	2200 7085	SPLIT	NBR
22.000	24.000	.813	2200 7085 V	SPLIT	FKM
22.000	24.000	.875	80042 ALL5LIFE	MIST	NBR
22.000	24.000	.875	80042 H1L5	MIST	NBR
22.000	24.000	.875	13043 H1L5	STLUP	NBR
22.000	24.000	1.000	2200 3839	SPLIT	NBR
22.000	24.000	1.281	13020 H1L5	STLPD	NBR
22.000	24.250	1.000	2200 14946	SPLIT	NBR
22.125	23.886	.750	2212 3985	SPLIT	NBR
22.125	24.125	.813	2212 6847	SPLIT	NBR
22.250	23.750	.625	7086 H1L5	RUP	NBR
22.250	23.750	.625	7086 H5L16	RUP	FKM
22.250	24.250	.813	7085 H1L5	RUP	NBR
22.250	24.250	.813	7085 H5L16	RUP	FKM
22.250	24.250	.813	2225 6847	SPLIT	NBR
22.250	24.250	.813	2225 6847 V	SPLIT	FKM

Shaft Dia.	Bore Dia.	Seal Width	Parker Part Number	Seal Type	Material
22.250	24.250	.875	80070 H1L5	MIST	NBR
22.250	24.250	1.000	3839 H1L5	RUP	NBR
22.250	24.250	1.000	3839 H5L16	RUP	FKM
22.250	24.500	1.000	14946 H1L5	RPD	NBR
22.250	24.750	1.000	2225 15467	SPLIT	NBR
22.250	26.250	1.925	19757 H1L5	LPDW	NBR
22.375	24.368	.875	15506 H1L5	STLUP	NBR
22.375	24.375	.813	2237 6847	SPLIT	NBR
22.375	24.375	.875	16999 STH1L5	STLUP	NBR
22.441	24.409	.787	30217 H1L5	RUP	NBR
22.500	1.125	1.125	13206 ALL5	MISC	NBR
22.500	24.000	.563	15909 H1L5	LUP	NBR
22.500	24.260	.750	3985 H1L5	RUP	NBR
22.500	24.260	.750	3985 H5L16	RUP	FKM
22.500	24.500	.813	2250 6847	SPLIT	NBR
22.500	24.500	.875	16585 H1L5	LUPW	NBR
22.500	24.500	1.000	12119 H1L5	LPD	NBR
22.500	24.750	.750	18019 H1L5	SSW	NBR
22.500	25.000	1.000	2250 15467	SPLIT	NBR
22.625	24.625	.500	19480 ALL5	SSW	NBR
22.630	24.750	.813	80098 H1L5	MIST	NBR
22.750	24.750	.813	2275 6847	SPLIT	NBR
22.750	28.500	2.404	18000 H1L5	LPDW	NBR
22.875	25.375	1.000	2287 15467	SPLIT	NBR
22.875	25.375	1.000	2287 16689	SPLIT	NBR
22.875	25.375	1.000	2287 9340	SPLIT	NBR
22.938	24.938	.813	2293 6847	SPLIT	NBR
22.990	24.990	.813	2299 6847	SPLIT	NBR
23.000	24.500	.750	15548 H1L5	STLUP	NBR
23.000	24.750	.750	9917 H1L5	LPD	NBR
23.000	24.750	.750	9917 H5L16	LPD	FKM
23.000	24.750	.750	9917 H5MX5489	LPD	FKM
23.000	24.813	.844	2300 16960	SPLIT	NBR
23.000	25.000	.813	2300 6847	SPLIT	NBR
23.000	25.000	.813	2300 6847 V	SPLIT	FKM
23.000	25.000	.813	2300 15095	SPLIT	NBR
23.000	25.000	.875	8942 H1L5	LPD	NBR
23.000	25.000	.875	15327 H1L5	STLUP	NBR
23.000	25.000	.875	80149 H1L5	STMIST	NBR
23.000	25.000	1.000	11105 H1L5	STLPD	NBR
23.000	25.000	1.000	17716 H1L5	STLUP	NBR
23.000	25.000	1.280	13021 H1L5	STLUP	NBR
23.000	25.375	.875	16874 H1L5	LUPW	NBR
23.000	25.375	.875	16874 H5L16	LUPW	FKM
23.000	25.500	1.000	2300 15467	SPLIT	NBR
23.000	25.500	1.000	2300 16689	SPLIT	NBR
23.000	25.500	1.000	2300 9340	SPLIT	NBR
23.000	25.500	1.000	20638 STH1L5	ST LPD	NBR
23.000	25.500	1.000	6822 H1L5	STLUP	NBR
23.218	25.718	1.000	2321 9340	SPLIT	NBR
23.250	23.750	1.000	16689 H1L5	RUPW	NBR
23.250	23.750	1.000	16689-S H1L5	RUPW	NBR
23.250	24.500	.625	20471 H1L5	LUP	NBR
23.250	25.063	.844	2325 16960	SPLIT	NBR
23.250	25.250	.813	6847 H1L5	RPD	NBR
23.250	25.250	.813	6847 H1L7	RPD	NBR
23.250	25.250	.813	6847 H5L16	RPD	FKM
23.250	25.250	.813	2325 15095	SPLIT	NBR
23.250	25.750	1.000	15467 H1L5	RUP	NBR
23.250	25.750	1.000	2325 9340	SPLIT	NBR
23.375	25.875	1.000	2337 9340	SPLIT	NBR
23.438	25.938	1.000	2343 9340	SPLIT	NBR
23.500	25.313	.844	2350 16960	SPLIT	NBR
23.500	25.500	.625	2350 11897	SPLIT	NBR
23.500	25.500	.813	15095 H1L5	RUP	NBR
23.500	25.500	.813	15095 H5L16	RUP	FKM

See Section 4 for seal type description. For High Misalignment sizes, see Page B-86.
For FlexiSeal Listings, see Pages B-93 and B-97.

03/03/06



Rotary Lip Seal Inch Sizes

23.500 to 26.250

B

Shaft Dia.	Bore Dia.	Seal Width	Parker Part Number	Seal Type	Material
23.500	25.500	1.000	13320 H1L5	STLPD	NBR
23.500	26.000	1.000	2350 9340	SPLIT	NBR
23.500	26.375	1.000	16811 H1L5	LUPW	NBR
23.523	25.523	.625	2352 11897	SPLIT	NBR
23.563	26.063	1.000	2356 9340	SPLIT	NBR
23.600	24.500	.750	80161 H1L5ST	STMIST	NBR
23.625	25.625	.625	2362 11897 V	SPLIT	FKM
23.625	26.125	1.000	2362 9340	SPLIT	NBR
23.750	25.750	.625	2375 11897	SPLIT	NBR
23.750	26.250	1.000	2375 9340	SPLIT	NBR
23.818	25.787	.787	19640 H1L5	LUP	NBR
23.875	26.375	1.000	2387 9340	SPLIT	NBR
23.938	25.938	.625	2393 11897	SPLIT	NBR
24.000	25.125	.500	2400 11806	SPLIT	NBR
24.000	25.500	.750	15073 H1L5	STLPD	NBR
24.000	25.813	.844	2400 16960	SPLIT	NBR
24.000	26.000	.625	2400 11897	SPLIT	NBR
24.000	26.000	.875	80077 H1L5	MIST	NBR
24.000	26.000	.875	13912 H1L5	STLPD	NBR
24.000	26.000	.875	13912 H1L20	STLPD	XNBR
24.000	26.000	1.000	17964 H1L7	H	NBR
24.000	26.000	1.000	2400 16507	SPLIT	NBR
24.000	26.000	1.000	2400 16507 V	SPLIT	FKM
24.000	26.250	1.000	10659 H1L5	STLPD	NBR
24.000	26.500	1.000	17090 H1L20	LUP	XNBR
24.000	26.500	1.000	17090 H1L5	LUP	NBR
24.000	26.500	1.000	2400 9340	SPLIT	NBR
24.240	26.240	1.000	2434 16507	SPLIT	NBR
24.250	26.063	.844	16960 H1L5	RUP	NBR
24.250	26.250	.625	2425 11897	SPLIT	NBR
24.250	26.625	.766	2425 18104	SPLIT	NBR
24.250	26.750	1.000	16841 H1L5	LDS	NBR
24.250	26.750	1.000	9340 H1L5	RUP	NBR
24.250	26.750	1.000	2425 13807	SPLIT	NBR
24.312	28.312	.250	19156 ALLL5	RPD	NBR
24.375	26.375	1.000	2437 17138	SPLIT	NBR
24.438	25.563	.500	2443 11806	SPLIT	NBR
24.438	26.438	.750	80048 STH1L5	MIST	NBR
24.438	26.438	.813	6991 H1L5	LPD	NBR
24.500	25.230	.750	20471 H1L20	OLLPD	XNBR
24.500	25.625	.500	2450 11806	SPLIT	NBR
24.500	26.500	.625	2450 11897	SPLIT	NBR
24.500	26.500	.875	15977 H1L5	STLUP	NBR
24.500	26.500	1.000	2450 16507	SPLIT	NBR
24.500	26.500	1.000	2450 17138	SPLIT	NBR
24.500	26.626	.765	12874 H1L5	RPD	NBR
24.500	26.875	.766	2450 18104	SPLIT	NBR
24.500	27.000	1.000	2450 13807	SPLIT	NBR
24.500	31.125	5.466	20584 H5MX5489 (special)	LUP-EL	FKM
24.625	26.750	.766	2462 13699	SPLIT	NBR
24.750	25.875	.500	2475 11806	SPLIT	NBR
24.750	26.750	.625	11897 H1L5	RPD	NBR
24.750	26.750	.625	11897 H5L16	RPD	FKM
24.750	26.750	1.000	2475 16507	SPLIT	NBR
24.750	27.125	.766	2475 18104	SPLIT	NBR
25.000	26.000	.125	13205 ALLL5	SPLC	NBR
25.000	26.500	.750	80074 STH1L5	MIST	NBR
25.000	26.500	.750	2500 18486	SPLIT	NBR
25.000	26.500	.750	2500 18486 V	SPLIT	FKM
25.000	26.500	.750	10286 H1L5	STLPD	NBR
25.000	26.500	.750	10286 H5L16	STLPD	FKM
25.000	27.000	.875	12572 H1L5	LPD	NBR
25.000	27.000	.906	12594 H1L5	STLPD	NBR
25.000	27.000	1.000	17138 H1L5	RUPW	NBR
25.000	27.000	1.000	2500 16507	SPLIT	NBR
25.000	27.375	.766	2500 18104	SPLIT	NBR

Shaft Dia.	Bore Dia.	Seal Width	Parker Part Number	Seal Type	Material
25.000	27.375	.875	16836 H1L5	LUPW	NBR
25.000	27.375	.875	16836 H5L16	LUPW	FKM
25.000	27.500	.875	13353 H1L5	LPDW	NBR
25.000	27.500	1.000	14670 H1L5	STLPD	NBR
25.000	27.500	1.000	2500 13807	SPLIT	NBR
25.000	27.500	1.870	16890 H1L5	LUPWEL	NBR
25.000	30.000	1.250	18756 H1L5	LPDWEL	NBR
25.120	27.628	1.250	2512 17042	SPLIT	NBR
25.125	27.625	1.000	2512 13807	SPLIT	NBR
25.250	26.750	.750	18486 H1L5	RUP	NBR
25.250	26.750	.750	18486 H5L16	RUP	FKM
25.250	27.250	1.000	2525 16507	SPLIT	NBR
25.250	27.750	1.000	2525 13807	SPLIT	NBR
25.310	27.820	1.250	2531 17042	SPLIT	NBR
25.375	27.500	.875	20749 H1L5	STLUP	NBR
25.375	27.875	1.000	2537 13807	SPLIT	NBR
25.492	28.000	1.250	2549 17042	SPLIT	NBR
25.500	26.625	.500	2550 11806	SPLIT	NBR
25.500	27.500	.875	6473 H1L5	LA	NBR
25.500	27.500	.875	6473 H5L16	LA	FKM
25.500	27.500	.875	9801 H1L5	STLUP	NBR
25.500	27.500	.875	9801 H5L16	STLUP	FKM
25.500	27.500	1.000	2550 16507	SPLIT	NBR
25.500	27.500	1.000	2550 18101	SPLIT	NBR
25.500	27.625	.766	2550 13699	SPLIT	NBR
25.500	28.000	1.000	2550 13807	SPLIT	NBR
25.500	28.008	1.250	2550 17042	SPLIT	NBR
25.590	26.715	.500	2559 11806 V	SPLIT	FKM
25.625	26.750	.500	2562 11806 V	SPLIT	FKM
25.625	28.000	.766	2562 18104	SPLIT	NBR
25.662	28.035	.765	2566 18104	SPLIT	NBR
25.740	28.250	1.250	19313 H1L5	RUPW	NBR
25.742	28.250	1.250	17042 H1L3	RUPW	NBR
25.742	28.250	1.250	17042 H1L5	RUPW	NBR
25.750	26.875	.500	2575 11806	SPLIT	NBR
25.750	27.750	1.000	2575 16507	SPLIT	NBR
25.750	27.875	1.000	19357 H1L5	RUPW	NBR
25.750	27.880	.766	2575 13699	SPLIT	NBR
25.750	28.125	.766	2575 18104	SPLIT	NBR
25.750	31.000	2.132	20448 H1L5	LUPEL	NBR
25.750	31.000	2.132	20448 H5L16	LUP-EL	FKM
25.875	28.000	.766	2587 13699	SPLIT	NBR
26.000	27.125	.500	11806 H1L5	RUP	NBR
26.000	27.125	.500	11806 H5L16	RUP	FKM
26.000	27.500	.750	13090 H1L7	H	NBR
26.000	28.000	.875	16221 H1L20	LUP	XNBR
26.000	28.000	.875	16221 H1L5	LUP	NBR
26.000	28.000	.875	16221 H5L16	LUP	FKM
26.000	28.000	.875	16221 H5MX5489	LUP	FKM
26.000	28.000	.875	13964 H1L5	STLPD	NBR
26.000	28.000	1.000	16507 H1L5	RUP	NBR
26.000	28.000	1.000	16507 H5L16	RUP	FKM
26.000	28.000	1.000	18101 H1L5	RUPW	NBR
26.000	28.000	1.000	2600 13807	SPLIT	NBR
26.000	28.000	1.000	2600 16340	SPLIT	NBR
26.000	28.000	1.000	10946 H1L5	STLPD	NBR
26.000	28.375	.766	18104 H1L5	RPD	NBR
26.000	28.500	.875	80071 H1L20	MIST	XNBR
26.000	28.500	1.000	17092 H1L5	LUP	NBR
26.000	28.500	1.000	2600 13807 V	SPLIT	FKM
26.127	28.250	.766	13699 H1L5	RPD	NBR
26.250	27.412	.500	18246 H1L5	RPD	NBR
26.250	28.750	1.000	13807 H1L5	RPD	NBR
26.250	28.750	1.000	13807 H5L16	RPD	FKM
26.250	28.750	1.000	13807 HL15	RPD	NBR
26.250	28.750	1.125	18245 H1L5	RPD	NBR

See Section 4 for seal type description. For High Misalignment sizes, see Page B-86. For FlexiSeal Listings, see Pages B-93 and B-97.

03/03/06



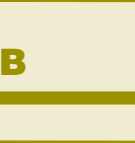

Shaft Dia.	Bore Dia.	Seal Width	Parker Part Number	Seal Type	Material
26.370	27.953	.709	30194 H1L5	RUP	NBR
26.370	27.953	.709	30194 H5L89	RUP	FKM
26.375	28.375	1.000	9897 H1L5	LPD	NBR
26.380	28.380	.813	2638 16510	SPLIT	NBR
26.500	28.000	.750	15661 H1L5	STLUP	NBR
26.500	28.000	.750	15661 H5L89	STLUP	FKM
26.625	28.625	1.000	17974 H1L5	RUPW	NBR
27.000	29.000	.812	2700 19902	SPLIT	NBR
27.000	29.000	.812	2700 19902 V	SPLIT	FKM
27.000	29.000	.813	2700 11300	SPLIT	NBR
27.000	29.000	.875	15424 H1L5	STLUP	NBR
27.000	29.000	.875	80141 H1L5	STMIST	NBR
27.000	29.000	1.000	10366 H1L5	STLPD	NBR
27.000	29.000	1.000	2700 16340	SPLIT	NBR
27.000	29.500	1.000	2700 9375	SPLIT	NBR
27.313	29.813	1.000	2731 9375	SPLIT	NBR
27.375	30.000	.765	2737 16975	SPLIT	NBR
27.500	28.625	.500	2750 16420	SPLIT	NBR
27.500	29.500	.812	19902 H1L5	RUP	NBR
27.500	29.500	.812	19902 H5L16	RUP	FKM
27.500	29.500	.813	2750 16510	SPLIT	NBR
27.500	29.500	.875	80052 H1L5	MIST	NBR
27.500	29.500	1.000	8903 H1L5	STLUP	NBR
27.500	30.125	.765	2750 16975	SPLIT	NBR
27.625	30.250	.765	2762 16975	SPLIT	NBR
27.750	30.375	.765	16975 H1L5	RPD	NBR
27.875	29.810	.875	6996 H1L5	STLPD	NBR
27.953	29.921	.984	19794 H1L5	LUP	NBR
28.000	29.125	.500	2800 16420	SPLIT	NBR
28.000	29.625	.750	10006 H1L5	STLPD	NBR
28.000	30.000	.813	2800 16510	SPLIT	NBR
28.000	30.000	.866	14624 H1L5	STLUP	NBR
28.000	30.000	.875	80053 H1L5	MIST	NBR
28.000	30.000	.875	80171 STH1L5	STMIST	NBR
28.000	30.000	1.000	2800 16340	SPLIT	NBR
28.000	30.500	.875	14669 H1L5	LPD	NBR
28.000	30.500	.875	14669 H5L16	LPD	FKM
28.000	30.500	1.000	13352 H1L5	LPDW	NBR
28.000	30.500	1.000	2800 9375	SPLIT	NBR
28.000	30.500	1.000	6841 H1L5	STLPD	NBR
28.000	32.000	.500	2800 17242	SPLIT	NBR
28.063	29.188	.500	2806 16420	SPLIT	NBR
28.370	32.375	1.045	17242 H1L5	RUPW	NBR
28.375	29.500	.500	16420 H1L5	RUP	NBR
28.375	30.875	1.000	2837 9375	SPLIT	NBR
28.375	30.875	1.000	2837 9375 V	SPLIT	FKM
28.380	26.380	.813	2838 16510	SPLIT	NBR
28.500	30.499	.875	18212 H1L5	LUP	NBR
28.500	30.499	.875	18212 H5L16	LUP	FKM
28.500	30.500	.813	2850 16510	SPLIT	NBR
28.500	30.500	.875	16369 H1L5	STLUP	NBR
28.500	30.500	1.000	17672 H1L5	OLLUP	NBR
28.500	31.000	1.000	2850 9375	SPLIT	NBR
28.750	30.750	.813	2875 16510	SPLIT	NBR
28.750	30.750	.875	80066 H1L5	MIST	NBR
28.750	30.750	1.000	2875 16339	SPLIT	NBR
28.750	30.750	1.000	2875 16340	SPLIT	NBR
28.750	31.125	1.000	2875 16493	SPLIT	NBR
28.750	31.250	1.000	2875 9375	SPLIT	NBR
29.000	31.000	.813	2900 16510	SPLIT	NBR
29.000	31.000	.875	8902 H1L5	STLUP	NBR
29.000	31.000	1.000	7177 H1L5	LPD	NBR
29.000	31.000	1.000	20706 ALLL5	LUPST	NBR
29.000	31.000	1.000	16340 H1L5	RUPW	NBR
29.000	31.000	1.000	16340 H5L16	RUPW	FKM
29.000	31.375	1.000	16493 H1L5	RUPW	NBR

Shaft Dia.	Bore Dia.	Seal Width	Parker Part Number	Seal Type	Material
29.000	31.375	1.000	19245 H1L5	RUP	NBR
29.000	31.500	1.000	2900 9375	SPLIT	NBR
29.313	31.313	.813	2931 16510	SPLIT	NBR
29.313	31.813	1.000	2931 9375	SPLIT	NBR
29.500	31.500	.813	2950 16510	SPLIT	NBR
29.500	31.500	.813	2950 11300	SPLIT	NBR
29.500	31.500	.875	15958 H1L5	STLUP	NBR
29.500	31.500	.875	2950 17390	SPLIT	NBR
29.500	32.000	.938	11056 H1L5	STLPD	NBR
29.500	32.000	1.000	2950 9375	SPLIT	NBR
29.625	30.625	.813	2962 16510	SPLIT	NBR
29.625	32.125	1.000	2962 9375	SPLIT	NBR
29.750	31.750	.875	17390 H1L5	RUP	NBR
29.750	32.250	1.000	2975 9375	SPLIT	NBR
30.000	31.125	.500	3000 16377	SPLIT	NBR
30.000	31.600	.775	10413 H1L5	STLPD	NBR
30.000	31.600	.775	80085 H1L5	STMIST	NBR
30.000	31.625	.750	80088 H1L5	MIST	NBR
30.000	31.630	.750	6224 H1L5	STLPD	NBR
30.000	31.630	.750	6224 H1L7	STLPD	NBR
30.000	32.000	.813	3000 16510	SPLIT	NBR
30.000	32.000	.813	3000 11300	SPLIT	NBR
30.000	32.000	.813	3000 11300 V	SPLIT	NBR
30.000	32.000	.875	12255 H1L5	STLPD	NBR
30.000	32.000	.875	3000 9845	SPLIT	NBR
30.000	32.000	1.000	3000 10274	SPLIT	NBR
30.000	32.000	1.000	3000 16339	SPLIT	NBR
30.000	32.500	1.000	9375 H1L5	RUP	NBR
30.000	32.500	1.000	9375 H1L7	RUP	NBR
30.000	32.500	1.000	9375 H5L16	RUP	FKM
30.000	32.500	1.250	3000 15370	SPLIT	NBR
30.250	31.375	.563	19966 H5MX5489	LUP	FKM
30.250	31.375	.563	3025 18722	SPLIT	NBR
30.250	31.375	.563	3025 18722 V	SPLIT	FKM
30.250	32.500	.875	80072 ALLL5	MIST	NBR
30.250	32.500	.875	80072 H1L20	MIST	XNBR
30.250	32.500	.875	80072 H1L5	MIST	NBR
30.315	33.268	1.094	13333 H1L5	STLPD	NBR
30.375	31.500	.500	16377 H1L5	RUP	NBR
30.375	32.375	.813	11300 H1L5	RPD	NBR
30.375	32.375	.813	11300 H5L16	RPD	FKM
30.375	32.375	.813	16510 H1L5	RUP	NBR
30.375	32.375	.875	3037 9845	SPLIT	NBR
30.500	31.996	.748	3050 18121	SPLIT	NBR
30.500	32.500	.875	12053 H1L5	STLPD	NBR
30.500	32.500	.875	3050 9845	SPLIT	NBR
30.500	33.000	1.000	15502 H1L5	STLUP	NBR
30.625	32.625	.875	3062 9845	SPLIT	NBR
30.625	32.625	1.000	3062 10274 V	SPLIT	FKM
30.727	32.727	.875	3072 9845	SPLIT	NBR
30.730	32.730	.875	3073 9845	SPLIT	NBR
30.750	32.750	.875	3075 9845	SPLIT	NBR
30.750	33.250	1.250	3075 15370	SPLIT	NBR
31.000	33.000	.813	8852 H1L5	LPD	NBR
31.000	33.000	.875	3100 9845	SPLIT	NBR
31.000	33.500	1.250	3100 15370	SPLIT	NBR
31.100	33.100	1.000	3110 16339	SPLIT	NBR
31.102	32.677	.906	30219 H5L16	STLUP	FKM
31.103	33.623	.984	80067 H1L5	MIST	NBR
31.125	33.125	1.000	3112 16339	SPLIT	NBR
31.250	33.250	1.000	3125 16339	SPLIT	NBR
31.500	33.500	.875	3150 9845	SPLIT	NBR
31.563	33.563	1.000	3156 10274	SPLIT	NBR
31.625	33.625	1.000	16339 H1L5	RUPW	NBR
31.750	33.750	.875	13106 H1L5	STLPD	NBR
31.843	34.344	1.250	3184 15370	SPLIT	NBR

See Section 4 for seal type description. For High Misalignment sizes, see Page B-86.
For FlexiSeal Listings, see Pages B-93 and B-97.

03/03/06



Rotary Lip Seal Inch Sizes

31.875 to 39.500

B

Shaft Dia.	Bore Dia.	Seal Width	Parker Part Number	Seal Type	Material
31.875	34.383	1.250	3188 15370	SPLIT	NBR
32.000	34.000	.750	18913 H1L5	LUP	NBR
32.000	34.000	1.000	3200 10274	SPLIT	NBR
32.000	34.500	1.250	17449 H1L5	LUP	NBR
32.000	34.500	1.250	3200 15370	SPLIT	NBR
32.250	34.250	1.000	3225 10274	SPLIT	NBR
32.283	34.803	.984	30199 H1L5	LUP	NBR
32.313	34.500	.315	15941 H1L5	STLUP	NBR
32.375	34.875	1.250	15370 H1L5	RUP	NBR
32.440	34.480	.875	3244 9845	SPLIT	NBR
32.489	34.489	.875	3248 9845	SPLIT	NBR
32.500	33.625	.563	3250 18722	SPLIT	NBR
32.500	34.500	.875	3250 9845	SPLIT	NBR
32.500	34.500	1.000	10322 H1L5	STLPD	NBR
32.500	34.500	1.000	3250 10274	SPLIT	NBR
32.500	34.500	1.000	3250 10274 V	SPLIT	FKM
32.750	34.750	1.000	3275 10274	SPLIT	NBR
32.756	34.252	.748	18286 H1L5	RUP	NBR
32.756	34.252	.748	18286 H5L16	RUP	FKM
32.875	34.000	.563	18722 H1L5	RUP	NBR
32.875	34.000	.563	18722 H5L16	RUP	FKM
32.875	34.000	.563	18722 H5MX5489	RUP	FKM
32.938	34.938	1.000	3293 10274	SPLIT	NBR
32.969	34.625	.750	80090 H1L5	MIST	NBR
32.969	34.625	.750	80090 STH1L5	MIST	NBR
32.972	34.683	.755	10506 H1L5	LPD	NBR
33.000	34.500	.750	19677 H1L20	SPCL	XNBR
33.000	34.625	.750	80058 H1L5	MIST	NBR
33.000	34.625	.750	80099 H1L5	MIST	NBR
33.000	34.688	.750	10260 H1L5	STLPD	NBR
33.000	35.000	.875	3300 9845	SPLIT	NBR
33.000	35.000	.875	80146 STH1L5	STMIST	NBR
33.000	35.500	1.000	10131 H1L5	LUP	NBR
33.000	35.500	1.000	11793 H1L5	STLPD	NBR
33.000	35.500	1.250	3300 17443	SPLIT	NBR
33.131	34.627	.748	18121 H1L5	RUP	NBR
33.250	35.750	1.000	3325 10274	SPLIT	NBR
33.469	35.469	.875	9845 H1L5	RPD	NBR
33.469	35.469	.875	9845 H5L16	RPD	FKM
33.500	35.500	.875	3350 4593	SPLIT	NBR
33.500	35.500	1.000	3350 10274	SPLIT	NBR
33.500	36.000	.875	15720 H1L5	LUPW	NBR
33.500	36.000	.875	15720 H1L5	LUPW	NBR
33.500	36.000	.875	9390 H1L5	STLPD	NBR
33.750	35.750	1.000	3375 10274	SPLIT	NBR
33.875	35.870	1.400	19263 H1L5	RUPW	NBR
34.000	36.000	.875	3400 4593	SPLIT	NBR
34.000	36.000	1.000	3400 10274	SPLIT	NBR
34.000	36.250	1.250	6681 H1L5	STLPD	NBR
34.000	36.500	.125	3400 15075	SPLIT	NBR
34.000	36.500	1.250	3400 17443	SPLIT	NBR
34.016	36.535	.984	30200 H1L5	LUP	NBR
34.125	36.125	1.000	3412 10274	SPLIT	NBR
34.252	36.772	.945	19544 H1L5	LUP	NBR
34.375	36.375	.875	3437 4593	SPLIT	NBR
34.375	36.875	1.250	17443 H1L5	RUP	NBR
34.500	36.500	.750	20688 H1L5	LUP	NBR
34.500	36.500	.875	6612 H1L5	LPD	NBR
34.500	36.500	.875	80112 H1L5	MIST	NBR
34.500	36.500	.875	3450 4593	SPLIT	NBR
34.500	36.500	.875	3450 4593 V	SPLIT	FKM
34.500	36.500	1.000	3450 16700	SPLIT	NBR
34.500	37.500	.750	9642 H1L5	STLPD	NBR
34.500	36.500	1.000	10274 H1L5	RPD	NBR
34.500	36.500	1.000	10274 H5L16	RPD	FKM
34.750	36.750	.875	80091 H1L5	MIST	NBR

Shaft Dia.	Bore Dia.	Seal Width	Parker Part Number	Seal Type	Material
34.750	36.750	.875	3475 4593	SPLIT	NBR
34.750	36.750	.875	15976 H1L5	STLUP	NBR
34.875	37.375	1.000	17633 H1L5	RUPW	NBR
35.000	37.000	.875	3500 4593	SPLIT	NBR
35.000	37.000	1.000	3500 16700	SPLIT	NBR
35.000	37.000	1.000	3500 17011	SPLIT	NBR
35.000	37.500	.750	11511 H1L5	STLPD	NBR
35.250	37.250	.875	3525 4593	SPLIT	NBR
35.250	37.250	1.000	3525 17011	SPLIT	NBR
35.500	37.500	.875	12972 H1L5	STLPD	NBR
35.500	37.500	.875	3550 4593	SPLIT	NBR
35.500	37.500	1.000	3550 17011	SPLIT	NBR
36.000	37.620	.750	11601 H1L5	LPD	NBR
36.000	37.620	.750	11601 STH1L5	STLPD	NBR
36.000	37.625	.750	3600 18433	SPLIT	NBR
36.000	38.000	.875	3600 4593	SPLIT	NBR
36.000	38.000	.875	80097 H1L5	MIST	NBR
36.000	38.500	.125	3600 15075	SPLIT	NBR
36.000	38.500	.875	80101 STH1L5	MIST	NBR
36.063	38.063	.875	3606 4593	SPLIT	NBR
36.500	38.438	1.000	3650 18565	SPLIT	NBR
36.500	38.500	.875	4593 H1L5	RPD	NBR
36.500	38.500	.875	4593 H5L16	RPD	FKM
36.500	39.000	.125	3650 15075	SPLIT	NBR
36.750	38.750	.875	16348 H1L5	STLUP	NBR
36.750	38.750	1.000	3675 17011	SPLIT	NBR
36.750	39.250	.125	3675 15075	SPLIT	NBR
37.000	39.250	.875	9456 H1L5	STLPD	NBR
37.000	39.500	.125	3700 15075	SPLIT	NBR
37.250	39.250	.875	80060 H1L5	MIST	NBR
37.250	39.250	1.000	3725 17011	SPLIT	NBR
37.500	39.000	.875	16851 H1L5	STLUP	NBR
37.500	39.500	.875	15347 H1L5	STLUP	NBR
37.500	39.500	1.000	16700 H1L5	RUP	NBR
37.500	39.500	1.000	3750 17011	SPLIT	NBR
37.500	39.508	.875	19893 H1L20	STLUP	XNBR
37.500	39.508	.875	19893 H1L5	STLUP	NBR
37.750	39.688	1.000	3775 18565	SPLIT	NBR
37.795	39.733	1.000	3779 8979	SPLIT	NBR
37.812	39.750	1.000	3781 18565	SPLIT	NBR
37.812	39.750	1.000	3781 8979	SPLIT	NBR
37.875	39.875	1.000	17011 H1L5	RUP	NBR
38.000	40.000	.875	80102 H1L5	MIST	NBR
38.000	40.000	.875	80102 ALLL20	MIST	XNBR
38.000	40.000	.875	80102 H1L20	MIST	XNBR
38.000	40.500	.125	3800 15075	SPLIT	NBR
38.000	41.000	.750	9641 H1L5	STLPD	NBR
38.250	40.250	1.000	19237 H1L5	RUPW	NBR
38.375	40.000	.750	18433 H1L5	RUP	NBR
38.500	40.000	.750	17798 H1L5	OLLUP	NBR
38.500	40.438	1.000	3850 8979	SPLIT	NBR
38.688	40.625	1.000	3868 18565	SPLIT	NBR
38.750	40.688	1.000	3875 18565	SPLIT	NBR
38.750	40.688	1.000	3875 8979	SPLIT	NBR
38.750	40.750	.875	15660 H1L5	STLUP	NBR
38.812	40.750	1.000	3881 8979	SPLIT	NBR
38.875	41.375	.125	15075 H1L3	RUP	CR
38.875	41.375	.125	15075 H1L5	RUP	NBR
39.000	40.938	1.000	3900 8979	SPLIT	NBR
39.125	41.063	1.000	18565 H1L5	RUP	NBR
39.125	41.063	1.000	18565 H1L50	RUP	NBR
39.250	40.750	.750	3925 13643	SPLIT	NBR
39.250	41.188	1.000	3925 8979	SPLIT	NBR
39.375	41.313	1.000	3937 8979	SPLIT	NBR
39.375	41.313	1.000	3937 8979 V	SPLIT	FKM
39.500	41.438	1.000	3950 8979	SPLIT	NBR

See Section 4 for seal type description. For High Misalignment sizes, see Page B-86. For FlexiSeal Listings, see Pages B-93 and B-97.

03/03/06



B

Shaft Dia.	Bore Dia.	Seal Width	Parker Part Number	Seal Type	Material
39.620	41.562	1.000	18258 H1L5	RUPW	NBR
39.750	41.688	1.000	8979 H1L5	RUP	NBR
39.750	41.688	1.000	8979 H5L16	RUP	FKM
39.750	42.250	.875	11439 H1L5	STLPD	NBR
40.000	42.000	.875	80162 H1L5ST	STMIST	NBR
40.000	42.000	1.000	6613 H1L5	OLLPD	NBR
40.125	41.625	.750	4012 13643	SPLIT	NBR
40.250	41.750	.750	4025 13643	SPLIT	NBR
40.500	42.000	.750	4050 13643	SPLIT	NBR
40.500	43.500	1.250	4050 17128	SPLIT	NBR
40.551	42.519	.984	30162 H1L5	RUP	NBR
40.551	42.519	.984	30162 H5L16	RUP	FKM
40.748	42.716	.984	30163 H1L5	RUP	NBR
41.000	44.000	1.250	4100 17128	SPLIT	NBR
41.250	42.750	.750	4125 13643	SPLIT	NBR
41.500	43.000	.750	4150 13643	SPLIT	NBR
41.500	43.500	.875	15894 H1L5	STLUP	NBR
41.500	43.500	.875	16244 H1L5	STLUP	NBR
42.000	43.500	.750	19008 H1L5	OLLUP	NBR
42.000	43.500	.750	4200 13643	SPLIT	NBR
42.050	44.571	.748	20583 H5L16	RUP	FKM
42.500	44.000	.750	4250 13643	SPLIT	NBR
42.500	45.000	.875	15211 H1L5	STLUP	NBR
42.750	44.250	.750	4275 13643	SPLIT	NBR
43.125	44.625	.750	13643 H1L5	RPD	NBR
43.500	45.000	.750	4350 13644	SPLIT	NBR
43.500	45.000	.750	4350 13644 V	SPLIT	FKM
43.500	45.500	.875	15599 H1L5	STLUP	NBR
43.500	45.500	.875	80062 H1L5	MIST	NBR
43.500	46.000	1.250	4350 17127	SPLIT	NBR
43.500	46.500	1.250	4350 17128	SPLIT	NBR
43.870	46.875	1.250	17128 H1L5	RUPW	NBR
43.875	46.375	1.250	17127 H1L5	SPCL	NBR
44.000	46.500	.875	18103 H1L5	STLPD	NBR
44.000	46.500	.875	18103 STH1L5	STLPD	NBR
44.000	46.500	1.000	14625 H1L5	STLUP	NBR
45.000	46.500	.750	4500 13644 V	SPLIT	FKM
45.250	47.125	.813	4525 10018	SPLIT	NBR
45.500	47.000	.750	4550 13644 HNBR	SPLIT	HNBR
45.500	47.000	.750	4550 13644 L20	SPLIT	XNBR
45.500	47.000	.750	4550 13644 XNBR	SPLIT	XNBR
46.000	48.000	.813	4600 18450	SPLIT	NBR
46.250	47.750	.750	4625 13644	SPLIT	NBR
46.250	48.250	.813	4625 18450	SPLIT	NBR
46.500	48.500	.813	4650 18450	SPLIT	NBR
46.500	48.500	.875	19862 H1L5	LUP	NBR
46.964	48.464	.750	4696 13644 HNBR	SPLIT	HNBR
47.375	48.875	.750	13644 H1L20	RPD	XNBR
47.375	48.875	.750	13644 H1L5	RPD	NBR
47.375	48.875	.750	13644 H1MX9508	RPD	HNBR

Shaft Dia.	Bore Dia.	Seal Width	Parker Part Number	Seal Type	Material
47.375	48.875	.750	13644 H5L16	RPD	FKM
48.000	50.000	.813	4800 18450	SPLIT	NBR
48.125	50.000	.813	10018 H1L5	RPD	NBR
48.250	50.250	.875	15597 H1L5	STLUP	NBR
48.250	50.250	.875	18154 H1L5	STLUP	NBR
48.250	50.250	.875	80113 H1L5	MIST	NBR
48.375	50.375	.813	18450 H1L5	RPD	NBR
49.250	51.125	.813	4925 11019	SPLIT	NBR
49.375	52.375	.750	4937 11432	SPLIT	NBR
49.375	52.375	.750	4937 11432 L50	SPLIT	NBR
49.500	51.375	.813	4950 11019	SPLIT	NBR
50.063	51.938	.813	5006 11019	SPLIT	NBR
50.750	52.625	.813	18133 H1L5	STLUP	NBR
50.750	52.625	.813	18133 STH1L5	STLUP	NBR
51.000	52.875	.813	5100 11019	SPLIT	NBR
51.125	53.000	.813	5112 11019	SPLIT	NBR
51.125	53.000	.813	5112 11019 V	SPLIT	FKM
52.250	54.125	.813	5225 11019	SPLIT	NBR
52.563	54.438	.813	5256 11019	SPLIT	NBR
52.625	54.500	.813	5262 11019	SPLIT	NBR
53.000	54.875	.813	11019 H1L5	RPD	NBR
53.000	54.875	.813	11019 H5L16	RPD	FKM
53.000	56.000	1.500	5300 10492	SPLIT	NBR
53.000	56.000	1.500	5300 10492 V	SPLIT	FKM
54.330	56.693	.980	19846 H1L5	LDS	NBR
55.000	58.000	.750	5500 11432	SPLIT	NBR
55.000	58.000	1.500	5500 10492	SPLIT	NBR
55.125	58.125	.750	5512 11432	SPLIT	NBR
55.250	58.250	.750	5525 11432	SPLIT	NBR
55.625	58.625	.750	5562 11432	SPLIT	NBR
56.000	59.000	.750	5600 11432	SPLIT	NBR
56.938	59.938	.750	5693 11432	SPLIT	NBR
57.000	60.000	.750	5700 11432	SPLIT	NBR
57.375	60.375	1.500	10492 H1L5	RPD	NBR
57.375	60.375	1.500	10492 H5L16	RPD	FKM
58.000	61.000	.750	5800 11432	SPLIT	NBR
58.000	61.000	.750	5800 11432 L50	SPLIT	NBR
58.500	61.500	.750	5850 11432	SPLIT	NBR
58.661	61.661	.750	5866 11432	SPLIT	NBR
59.000	62.000	.750	5900 11432	SPLIT	NBR
59.000	62.000	.750	5900 11432 V	SPLIT	FKM
59.125	62.125	.750	5912 11432	SPLIT	NBR
59.500	62.500	.750	11432 H1L5	RPD	NBR
59.500	62.500	.750	11432 H1L20	RPD	XNBR
59.500	62.500	.750	11432 H1L50	RPD	NBR
59.500	62.500	.750	11432 H5L16	RPD	FKM
59.500	62.500	.750	5950 19704 V	SPLIT	FKM
61.250	63.250	1.000	80172 H1L5	STMIST	NBR
65.000	68.000	.750	19704 H5L16	RUP	FKM

See Section 4 for seal type description. For High Misalignment sizes, see Page B-86.
For FlexiSeal Listings, see Pages B-93 and B-97.

03/03/06



High Misalignment Inch

1.000 to 3.000

Catalog EPS 5350/USA

Dimensions — LUPW, LPDW and LDSW Profiles

Shaft Dia.	Bore Dia.	OD Press Fit Width	*Installed Seal Width	Seal Type	Material	Max. +/- Eccentricity	Parker Part Number
1.000	1.850	0.375	0.375	LPDW	NBR	0.044	15404 H1L5
1.250	2.063	0.438	0.438	LPDW ¹	NBR	0.060	14799 H1L5
1.250	2.250	0.500	0.500	LDS	NBR	0.030	15949 H1L5
1.375	2.250	0.375	0.375	LUPW	NBR	0.094	16435 H1L5
1.375	2.443	0.375	0.375	LPDW ¹	NBR	0.060	14833 H1L5
1.375	2.443	0.375	0.375	LPDW	FKM	0.060	14833 H5L16
1.531	2.500	0.438	0.438	LPDW	NBR	0.087	9923 H1L5
1.531	2.755	0.500	0.500	LPDW ¹	NBR	0.060	9893 H1L5
1.625	2.330	0.454	0.454	LUPW	NBR	0.095	19817 H1L5
1.748	2.624	0.438	0.438	LPDW ¹	NBR	0.062	11813 H1L5
1.753	2.563	0.438	0.438	LPDW	NBR	0.065	11812 H1L5
1.772	2.375	0.438	0.438	LUPW	NBR	0.090	18404 H1L5
1.938	2.500	0.375	0.375	LPDW	NBR	0.030	15113 H1L5
1.938	3.003	0.438	0.438	LUPW	NBR	0.090	18405 H1L5
1.938	3.003	0.438	0.438	LUPW	FKM	0.090	18405 H5MX5489
2.000	2.750	0.375	0.375	LPDW ¹	NBR	0.060	13847 H1L5
2.000	3.000	0.500	0.500	LPDW	NBR	0.060	14783 H1L5
2.125	3.189	0.500	0.500	LUPW	NBR	0.060	9922 H1L5
2.140	3.500	0.500	0.500	LPDW	NBR	0.005	10158 H1L5
2.239	3.545	0.344	0.344	LUPW	NBR	0.035	17514 H1L5
2.250	2.750	0.313	0.313	LUPW	NBR	0.025	16232 H1L5
2.250	2.875	0.313	0.313	LPDW ¹	NBR	0.020	12246 H1L5
2.250	3.250	0.500	0.500	LUPW	NBR	0.050	17307 H1L5
2.250	3.250	0.500	0.500	LUPW	N/P	0.050	17307 H1L5 PTFE
2.250	3.250	0.500	0.500	LUPW	FKM	0.050	17307 H5L16
2.313	3.063	0.375	0.375	LPDW	NBR	0.072	15163 H1L5
2.330	3.252	0.438	0.438	LPDW	NBR	0.062	12498 H1L5
2.375	3.375	0.500	0.500	LPDW ¹	NBR	0.080	10899 H1L5
2.498	3.501	0.500	0.500	LPDW	NBR	0.080	11814 H1L5
2.498	3.501	0.500	0.500	LPDW	FKM	0.080	11814 H5L16
2.498	3.501	0.500	0.500	LPDW	NBR	0.080	11814 HL15
2.500	3.125	0.313	0.313	LPDW	NBR	0.030	15117 H1L5
2.500	3.500	0.500	0.500	LUPW	NBR	0.060	19203 H1L5
2.500	3.750	0.563	0.563	LPDW ¹	NBR	0.065	13244 H1L5
2.500	3.938	0.563	0.563	LPDW ¹	NBR	0.062	14048 H1L5
2.500	4.331	0.563	0.563	LPDW ¹	NBR	0.062	14053 H1L5
2.500	4.726	0.470	0.470	LPDW	NBR	0.062	14052 H1L5
2.620	3.250	0.313	0.313	LUPW	NBR	0.042	17047 H1L5
2.620	3.250	0.313	0.313	LUPW	FKM	0.042	17047 H5L16
2.625	3.623	0.500	0.500	LPDW	NBR	0.090	12141 H1L5
2.750	3.750	0.500	0.500	LUPW	NBR	0.080	11023 H1L5
2.750	3.750	0.500	0.500	LUPW	NBR	0.080	11023 H1L50
2.750	4.125	0.563	0.563	LUPW ¹	NBR	0.066	12728 H1L5
2.781	3.751	0.500	0.500	LPDW	NBR	0.031	10157 H1L5
2.813	4.000	0.500	0.500	LPDW	NBR	0.047	12347 H1L5
2.875	3.625	0.375	0.375	LPDW ¹	NBR	0.050	13137 H1L5
2.875	3.752	0.500	0.500	LPDW	NBR	0.047	12496 H1L5
2.998	4.004	0.438	0.438	LPDW	NBR	0.062	12652 H1L5
3.000	3.750	0.375	0.375	LPDW	NBR	0.060	10902 H1L5
3.000	4.000	0.500	0.500	LPDW	NBR	0.100	10901 H1L5
3.000	4.000	0.500	0.500	LPDW	NBR	0.100	10901 H1L70
3.000	4.000	0.500	0.500	LUPW	NBR	0.020	16233 H1L5
3.000	4.125	0.500	0.500	LPDW ¹	NBR	0.079	15911 H1L5
3.000	5.118	0.625	0.625	LUPW	NBR	0.062	14055 H1L5

*EL = Extended Lip. Additional housing width required for seal lip to fully operate, includes 10% allowance

¹ Spring Retainer

² Special

See Section 4 for seal type description.

03/03/06



Shaft Dia.	Bore Dia.	OD Press Fit Width	*Installed Seal Width	Seal Type	Material	Max. +/- Eccentricity	Parker Part Number
3.000	5.512	0.625	0.625	LUPW	NBR	0.062	14056 H1L5
3.063	4.063	0.375	0.507	LUPW	NBR	0.060	16010 H1L5
3.125	3.875	0.375	0.375	LPDW	XNBR	0.084	15164 H1L20
3.125	3.875	0.375	0.375	LPDW	NBR	0.084	15164 H1L5
3.125	3.875	0.375	0.375	LPDW	FKM	0.084	15164 H5MX5489
3.250	4.000	0.313	0.313	LPDW	NBR	0.005	10973 H1L5
3.250	4.250	0.500	0.500	LPDW ¹	NBR	0.060	12268 H1L5
3.250	4.500	0.625	0.625	LPDW ¹	NBR	0.078	12645 H1L5
3.250	4.500	0.625	0.625	LPDW ¹	FKM	0.078	12645 H5L16
3.250	4.500	0.438	0.438	LUPW	NBR	0.031	17833 H1L5
3.375	4.500	0.500	0.500	LPDW ¹	EPDM	0.030	15114 H1L2160
3.375	4.500	0.500	0.500	LPDW ¹	NBR	0.030	15114 H1L5
3.375	4.500	0.500	0.500	LPDW ¹	FKM	0.030	15114 H5L16
3.500	4.500	0.625	0.625	LPDW	NBR	0.075	10914 H1L5
3.500	4.500	0.625	0.625	LPDW	FKM	0.075	10914 H5L16
3.500	4.750	0.500	0.500	LUPW	NBR	0.060	17544 H1L5
3.500	4.750	0.500	0.500	LUPW	FKM	0.060	17544 H5L16
3.500	5.000	0.562	0.562	LPDW	NBR	0.092	9457 H1L5
3.500	5.500	0.563	0.563	LPDW ¹	NBR	0.062	12442 H1L5
3.500	5.906	0.625	0.625	LPDW ¹	NBR	0.061	14054 H1L5
3.500	5.906	0.625	0.625	LPDW ¹	N/P	0.061	14054 H1L5 PTFE
3.563	4.563	0.500	0.500	LUPW	NBR	0.050	16652 H1L5
3.625	4.625	0.500	0.500	LPDW ¹	NBR	0.066	13136 H1L5
3.750	4.750	0.500	0.500	LUPW	NBR	0.100	11102 H1L5
3.750	5.125	0.625	0.625	LPDW	NBR	0.078	10156 H1L5
3.750	5.126	0.625	0.625	LPDW	NBR	0.078	10156 H1L3
3.750	5.250	0.281	0.523	RUP-EL	NBR	0.005	18268 H1L5
3.875	4.750	0.438	0.438	LPDW	NBR	0.060	15389 H1L5
3.875	4.875	0.625	0.625	LPDW ¹	NBR	0.076	10926 H1L5
3.875	4.875	0.625	0.625	LPDW ¹	FKM	0.076	10926 H5L16
3.938	4.965	0.305	0.305	LUPW	NBR	0.060	17085 H1L5
3.938	5.000	0.500	0.500	LPDW	NBR	0.086	11239 H1L5
3.938	5.000	0.500	0.500	LPDW	N/P	0.086	11239 H1L5 PTFE
3.938	5.000	0.500	0.500	LPDW	FKM	0.086	11239 H5L16
3.938	5.000	0.500	0.500	LDSW	NBR	0.067	16170 H1L5
4.000	5.000	0.438	0.438	LPDW ¹	NBR	0.068	12628 H1L5
4.000	5.000	0.500	0.500	LUPW	NBR	0.060	19204 H1L5
4.000	5.375	0.437	0.613	MIST-EL	NBR	0.160	80106 H1L5
4.000	5.500	0.563	0.563	LPDW	NBR	0.092	9458 H1L5
4.000	5.500	0.563	0.563	LPDW	FKM	0.092	9458 H5L16
4.000	5.750	0.656	0.656	LUPW	NBR	0.086	13127 H1L5
4.000	6.299	0.563	0.563	LPDW	NBR	0.080	14259 H1L5
4.125	5.125	0.375	0.688	LPDW	NBR	0.125	14142 H1L5
4.125	5.625	0.750	0.750	RUPW	NBR	0.050	19232 H1L5
4.188	5.235	0.306	0.306	LUPW	NBR	0.060	17393 H1L5
4.250	5.250	0.500	0.500	LPDW ¹	NBR	0.074	13653 H1L5
4.250	5.250	0.500	0.500	LPDW ¹	FKM	0.074	13653 H5L89
4.250	5.250	0.438	0.438	LUPW	NBR	0.031	17856 H1L5
4.250	5.375	0.563	0.563	LPDW ¹	NBR	0.100	10428 H1L5
4.250	6.000	0.719	0.719	LPDW ¹	NBR	0.080	13013 H1L5
4.438	5.500	0.562	0.562	LPDW	NBR	0.100	11296 H1L5
4.438	5.500	0.562	0.562	LPDW	N/P	0.100	11296 H1L5 PTFE
4.438	5.500	0.562	0.562	LPDW	FKM	0.100	11296 H5L16
4.500	5.500	0.500	0.500	LPDW ¹	NBR	0.031	10354 H1L5
4.500	5.500	0.500	0.500	LPDW ¹	N/P	0.031	10354 H1L5 PTFE
4.500	5.500	0.500	0.500	LPDW ¹	FKM	0.031	10354 H5L16
4.500	6.000	0.563	0.563	LPDW	NBR	0.060	12269 H1L5
4.500	6.000	0.563	0.563	LPDW	FKM	0.060	12269 H5MX5489
4.535	7.087	0.313	0.465	LUPW-EL ²	NBR	0.035	17578 H1L5
4.563	5.750	0.563	0.563	LPD	NBR	0.005	15070 H1L5

*EL = Extended Lip. Additional housing width required for seal lip to fully operate, includes 10% allowance

¹ Spring Retainer

² Special

See **Section 4** for seal type description.

03/03/06



B

Shaft Dia.	Bore Dia.	OD Press Fit Width	*Installed Seal Width	Seal Type	Material	Max. +/- Eccentricity	Parker Part Number
4.563	5.750	0.563	0.563	LPD	FKM	0.005	15070 H5L16
4.750	5.750	0.500	0.500	LUPW	NBR	0.035	16222 H1L5
4.750	5.750	0.500	0.500	LUPW	FKM	0.035	16222 H5L16
4.750	6.500	0.781	0.781	LPDW ¹	NBR	0.080	12766 H1L5
4.812	6.250	0.500	1.058	LPDW-EL ¹	NBR	0.250	18017 H1L5
4.813	6.250	0.625	0.625	LPDW ¹	NBR	0.188	9434 H1L50
4.813	6.000	0.375	0.792	LPDW ¹	NBR	0.156	14647 H1L5
4.813	6.250	0.625	0.625	LPDW	NBR	0.188	9434 H1L5
4.875	6.000	0.500	0.500	LUPW	NBR	0.060	19205 H1L5
4.938	5.985	0.305	0.305	LUPW	NBR	0.060	16992 H1L5
4.938	6.250	0.562	0.562	LPDW ¹	NBR	0.111	10978 H1L5
5.000	6.125	0.500	0.500	LPDW	NBR	0.117	15154 H1L5
5.000	6.125	0.500	0.500	LPDW	FKM	0.117	15154 H5MX5489
5.000	6.250	0.625	0.625	LPDW	NBR	0.096	10906 H1L5
5.000	6.250	0.625	0.625	LPDW	FKM	0.096	10906 H5L16
5.000	6.250	0.500	0.500	LPDW ¹	NBR	0.082	13176 H1L5
5.063	6.250	0.625	0.625	LPDW ¹	NBR	0.096	11852 H1L5
5.125	6.125	0.500	0.500	LUPW	NBR	0.035	16223 H1L5
5.125	6.125	0.500	0.500	LUPW	FKM	0.035	16223 H5L16
5.250	6.500	0.562	0.562	LPDW	NBR	0.062	20412 H1L5
5.250	6.750	0.625	0.625	LUPW	FKM	0.032	20416 H5MX5489
5.250	6.764	0.564	0.564	LPDW	NBR	0.005	17394 H1L5
5.250	6.812	0.500	1.056	LPDW-EL ¹	NBR	0.250	17951 H1L5
5.250	6.812	0.500	1.056	LPDW-EL ¹	FKM	0.250	17951 H5MX5489
5.500	6.500	0.500	0.500	LUPW	NBR	0.100	19402 H1L5
5.500	6.750	0.625	0.625	LUPW	NBR	0.040	16239 H1L5
5.500	6.750	0.625	0.625	LUPW	FKM	0.040	16239 H5L16
5.750	6.750	0.500	0.500	LUPW	NBR	0.035	16748 H1L5
5.750	6.750	0.500	0.500	LUPW	EPDM	0.035	16748 MX9010L21
5.750	6.750	0.500	0.500	LUPW ¹	XNBR	0.024	19449 H1L20
5.750	6.750	0.500	0.500	LUPW ¹	NBR	0.024	19449 H1L7
5.750	7.000	0.625	0.625	LUPW	NBR	0.125	17301 H1L5
5.750	7.125	0.563	0.563	LPDW ¹	NBR	0.109	13825 H1L5
5.872	7.500	0.562	0.562	LUPW	NBR	0.210	20437 H1L5
5.872	7.500	0.562	0.562	LUPW	FKM	0.210	20437 H5L89
5.938	7.000	0.563	0.563	LPDW	NBR	0.109	10263 H1L5
5.938	7.000	0.563	0.563	LPDW	N/P	0.109	10263 H1L5 PTFE
5.938	7.000	0.563	0.563	LPDW	FKM	0.109	10263 H5L16
5.938	7.000	0.563	0.563	LPDW	NBR	0.188	19193 H1L5
5.938	7.000	0.563	0.563	LPDW	FKM	0.188	19193 H5L16
6.000	7.000	0.438	0.438	LUPW	NBR	0.031	17861 H1L5
6.000	7.000	0.438	0.438	LUPW	FKM	0.031	17861 H5L16
6.000	7.000	0.437	0.437	LUPW	NBR	0.060	17956 H1L5
6.000	7.000	0.437	0.437	LUPW	FKM	0.060	17956 H5L16
6.000	7.500	0.750	0.750	LPDW ¹	NBR	0.100	11077 H1L5
6.000	7.500	0.675	0.675	LUPW	NBR	0.125	17300 H1L5
6.000	7.500	0.675	0.675	LUPW	FKM	0.125	17300 H5L16
6.000	7.625	1.000	1.000	LUPW	NBR	0.250	15160 H1L5
6.000	8.375	0.375	0.825	LPDW	NBR	0.188	6445 H1L5
6.375	7.375	0.625	0.625	LUPW	NBR	0.035	16214 H1L5
6.375	7.375	0.625	0.625	LUPW	FKM	0.035	16214 H5L16
6.375	7.750	0.500	0.500	LUPW	NBR	0.050	16828 H1L5
6.375	8.000	0.625	0.912	LUPW	NBR	0.163	19982 H1L5
6.500	8.336	0.500	0.500	LUPW ²	NBR	0.070	18430 H1L5
6.500	8.336	0.500	0.500	LUPW ²	FKM	0.070	18430 H5L16
6.750	7.750	0.750	0.750	LUPW	NBR	0.040	16215 H1L5
6.750	7.750	0.750	0.750	LUPW	FKM	0.040	16215 H5L16
6.750	8.250	0.625	0.625	LPDW ¹	NBR	0.162	15459 H1L5
6.750	8.250	0.625	0.625	LPDW ¹	FKM	0.162	15459 H5L16
6.750	8.250	0.625	0.625	LUPW	NBR	0.125	16600 H1L5

*EL = Extended Lip. Additional housing width required for seal lip to fully operate, includes 10% allowance

¹ Spring Retainer

² Special

See Section 4 for seal type description.

03/03/06



Shaft Dia.	Bore Dia.	OD Press Fit Width	*Installed Seal Width	Seal Type	Material	Max. +/- Eccentricity	Parker Part Number
6.750	8.250	0.625	0.625	LUPW	FKM	0.125	16600 H5L16
6.875	8.388	0.375	0.375	LUPW	NBR	0.062	17018 H1L5
7.000	7.938	0.500	0.500	LUPW	NBR	0.035	16749 H1L5
7.000	8.000	0.625	0.625	LUPW	NBR	0.096	10907 H1L5
7.000	8.000	0.625	0.625	LUPW	FKM	0.096	10907 H5L16
7.000	8.000	0.625	0.625	LDSW	CR	0.036	13476 H1L3
7.000	8.000	0.625	0.625	LDSW	NBR	0.036	13476 H1L5
7.000	8.000	0.625	0.625	LUPW	XNBR	0.024	19450 H1L20
7.000	8.000	0.625	0.625	LUPW	NBR	0.024	19450 H1L7
7.008	8.386	0.375	0.468	LUPW	FKM	0.125	19276 H5L16
7.125	8.125	0.500	0.500	LUPW	NBR	0.100	19403 H1L5
7.125	8.250	0.750	0.750	LUPW	NBR	0.035	16213 H1L5
7.125	8.250	0.750	0.750	LUPW	FKM	0.035	16213 H5L16
7.200	8.995	0.500	0.500	LUPW ²	NBR	0.070	18431 H1L5
7.205	8.583	0.276	0.276	LUPW	NBR	0.062	18910 H1L5
7.224	9.875	0.500	0.963	LPD-EL	NBR	0.005	19363 H1L5
7.224	9.875	0.500	0.963	LPD-EL	NBR	0.262	8881 H1L5
7.224	9.875	0.500	0.963	LPD-EL	FKM	0.262	8881 H5L16
7.250	9.500	.750	1.436	LPDW-EL ¹	NBR	0.312	18747 H1L5
7.500	8.500	0.625	.625	LUPW ¹	FKM	0.024	19446 H5MX5489
7.500	9.000	0.750	0.750	LPDW	NBR	0.030	19581 H1L5
7.500	9.000	0.750	0.750	LPDW	FKM	0.030	19581 H5L16
7.500	9.000	0.750	0.750	LPDW	FKM	0.030	19581 H5MX5489
7.500	9.313	0.813	1.059	LUPW ¹	NBR	0.250	18554 H1L5
7.500	9.313	0.813	1.059	LUPW ¹	FKM	0.250	18554 H5L16
7.750	8.750	0.500	0.500	LUPW	NBR	0.035	16750 H1L5
7.750	8.750	0.500	0.500	LUPW	FKM	0.035	16750 H5L16
7.750	9.250	0.625	0.625	LUPW	NBR	0.113	17444 H1L5
7.750	9.375	0.625	0.625	LPDW	NBR	0.179	15460 H1L5
7.750	9.375	0.625	0.625	LPDW	FKM	0.179	15460 H5L16
7.750	9.375	0.625	0.625	LPDW	FKM	0.179	19724 ALLL16
7.75	9.375	0.625	0.625	LPDW	NBR	0.179	15460 H1L5
7.750	9.375	0.625	0.625	LPDW	FKM	0.179	15460 H1L5
7.813	9.345	0.375	0.375	LUPW	NBR	0.062	17017 H1L5
7.870	10.000	0.750	1.463	LUPW	NBR	0.375	17148 H1L5
8.000	9.000	0.625	0.625	LUPW	XNBR	0.024	19451 H1L20
8.000	9.000	0.625	0.625	LUPW	NBR	0.030	19451 H1L7
8.000	9.500	0.750	0.750	LPDW ¹	NBR	0.094	14032 H1L5
8.000	9.500	0.750	0.750	LPDW ¹	FKM	0.094	14032 H5L16
8.045	9.906	0.500	0.583	LPDW ¹	NBR	0.014	14737 H1L5
8.045	9.906	0.500	0.583	LPDW ¹	FKM	0.014	14737 H5L16
8.250	9.500	0.625	0.625	LUPW ¹	FKM	0.024	19447 H5MX5489
8.250	10.250	0.813	0.813	LUPW	NBR	0.075	17904 H1L5
8.250	10.250	0.813	0.813	LUPW	FKM	0.075	17904 H5L16
8.250	10.500	.750	1.342	LPDW	NBR	0.375	18037 H1L5
8.250	11.000	0.625	1.650	LUP-EL	NBR	0.563	20542 H1L5
8.375	10.500	0.500	0.935	LPDW ¹	NBR	0.281	14428 H1L5
8.500	10.500	0.750	0.750	LUPW	NBR	0.198	16930 H1L5
8.500	11.000	0.750	0.750	LUPW-ST	XNBR	0.276	20405 H1L20
8.500	11.000	0.750	0.750	LUPW-ST	NBR	0.276	20405 H1L5
8.500	11.250	0.500	0.963	MIST-EL	FKM	0.270	80105 H5MX5489
8.750	10.250	0.688	0.688	LUPW	NBR	0.075	17902 H1L5
8.750	10.250	0.688	0.688	LUPW	FKM	0.075	17902 H5L16
8.750	11.250	0.750	0.750	RUPW	NBR	0.060	19870 H1L5
9.000	10.500	0.688	0.688	LUPW	NBR	0.075	17912 H1L5
9.000	10.500	0.625	0.625	LUPW	FKM	0.188	19586 H5L16
9.000	10.500	0.625	0.625	LUPW	FKM	0.188	19586 H5MX5489
9.000	10.500	0.625	0.625	LUPW	FKM	0.188	19586 H5MX9514
9.000	10.750	0.688	1.068	LUPW	NBR	0.400	19990 H1L5
9.125	10.625	0.688	0.688	LUPW	NBR	0.048	16555 H1L5

*EL = Extended Lip. Additional housing width required for seal lip to fully operate, includes 10% allowance

¹ Spring Retainer

² Special

See **Section 4** for seal type description.

03/03/06



B

Shaft Dia.	Bore Dia.	OD Press Fit Width	*Installed Seal Width	Seal Type	Material	Max. +/- Eccentricity	Parker Part Number
9.125	10.625	0.688	0.688	LUPW	FKM	0.048	16555 H5L89
9.125	11.125	0.813	0.813	LUPW	NBR	0.048	16556 H1L5
9.188	11.500	1.000	1.000	LPDW	NBR	0.032	9536 H1L5
9.188	11.500	1.000	1.000	LPDW	FKM	0.060	9536 H5L16
9.250	11.500	0.750	1.342	LPDW-EL	NBR	0.375	18757 H1L5
9.250	11.500	0.750	0.750	LUPW	NBR	0.215	16782 H1L5
9.250	11.500	0.750	0.750	LUPW	FKM	0.215	16782 H5L16
9.250	11.875	0.875	1.265	STLPDW ¹	NBR	0.250	19216 H1L5
9.250	12.000	0.625	1.057	LPD-EL	NBR	0.187	19908 H1L5
9.500	11.500	1.000	1.320	LPDW	NBR	0.300	17382 H1L5
9.500	11.500	0.813	0.813	LUPW	NBR	0.093	17855 H1L5
9.500	11.500	0.813	0.813	LUPW	NBR	0.093	17855 H1L70
9.500	11.500	0.813	0.813	LUPW	FKM	0.093	17855 H5L16
9.500	11.500	0.812	0.812	LPDW ¹	NBR	0.150	19103 H1L5
9.750	11.625	0.625	1.815	LPDW-EL	NBR	0.437	18158 H1L5
9.750	11.625	0.625	1.815	LPDW	FKM	0.437	18158 H5L16
10.000	11.500	0.750	0.750	LUPW	FKM	0.024	19799 H5MX5489
10.000	12.000	0.813	0.813	LUPW	NBR	0.048	16563 H1L5
10.000	12.000	0.813	0.813	LUPW	FKM	0.045	16563 H5L16
10.000	13.250	0.625	1.166	LPDW ¹	NBR	0.312	15468 H1L5
10.000	13.500	0.750	1.238	LUP-EL	NBR	0.500	20460 H1L5
10.000	14.000	0.750	2.475	LUP-EL	NBR	0.813	20543 H1L5
10.125	11.750	0.688	0.688	LUPW	NBR	0.045	16564 H1L5
10.125	12.000	0.750	0.750	LUPW	NBR	0.045	16565 H1L5
10.236	12.202	0.790	0.790	LUPW	NBR	0.125	19295 H1L5
10.490	12.500	0.750	1.463	LUPW	NBR	0.375	17145 H1L5
10.500	12.000	0.688	0.688	LUPW	NBR	0.045	16568 H1L5
10.500	12.000	0.688	0.688	LUPW	FKM	0.045	16568 H5L16
10.500	12.000	0.688	0.688	LUPW	NBR	0.188	16922 H1L5
10.500	12.000	0.688	0.688	LUPW	FKM	0.188	16922 H5L16
10.500	12.750	1.250	1.250	LPDW	NBR	0.265	9347 H1L5
10.500	14.500	1.000	1.000	LPDW ¹	NBR	0.250	14982 H1L5
10.750	12.750	1.000	1.000	RPD	NBR	0.050	19654 H1L5
11.000	13.000	1.000	1.375	LPDW	NBR	0.312	17333 H1L5
11.000	13.000	1.000	1.375	LPDW	FKM	0.312	17333 H5L89
11.000	13.125	0.750	2.131	LPDW	NBR	0.500	18050 H1L5
11.000	13.125	0.750	2.131	LPDW	FKM	0.500	18050 H5L16
11.000	14.750	0.750	2.178	LUPW-EL	NBR	0.750	20510 H1L5
11.375	13.375	0.813	0.813	LUPW	NBR	0.045	16573 H1L5
11.375	13.375	0.813	0.813	LUPW	FKM	0.045	16573 H5L16
11.500	13.000	0.688	0.688	LUPW	XNBR	0.188	16822 H1L20
11.500	13.000	0.688	0.688	LUPW	NBR	0.188	16822 H1L5
11.500	13.000	0.688	0.688	LUPW	FKM	0.188	16822 H5L16
11.500	13.125	0.750	0.750	LUPW	FKM	0.187	19587 H5L16
11.500	13.125	0.750	0.750	LUPW	FKM	0.187	19587 H5L89MON
11.500	13.125	0.750	0.750	LUPW	FKM	0.187	19587 H5MX5489
11.500	13.500	1.000	1.000	RUPW	NBR	0.050	19219 H1L5
11.500	13.500	1.000	1.000	RUPW	FKM	0.050	19219 H5MX5489
11.500	14.625	0.750	2.178	LUP-EL	NBR	0.500	20594 H1L5
11.625	15.000	0.625	1.238	LPDW	NBR	0.375	19163 H1L5
11.750	13.250	0.688	0.688	LUPW	NBR	0.045	16574 H1L5
11.750	13.250	0.688	0.688	LUPW	FKM	0.045	16574 H5L16
11.938	13.938	0.750	0.750	RUPW	NBR	0.250	19251 H1L5
11.992	14.000	0.750	1.463	LUPW	NBR	0.375	17146 H1L5
12.000	13.500	0.625	0.625	LUPW ¹	NBR	0.125	15678 H1L5
12.000	13.500	0.625	0.625	LUPW ¹	FKM	0.125	15678 H5L89
12.000	15.062	0.750	1.535	LUPW-EL	NBR	0.562	20690 H1L5
12.000	15.688	0.750	1.991	LUP-EL	NBR	0.750	20523 H1L5
12.180	13.353	1.500	1.500	RPDEL ²	H1	0.000	16274 H1
12.180	14.187	1.500	1.500	RPDEL ²	NBR	0.000	16273 H1L5

*EL = Extended Lip. Additional housing width required for seal lip to fully operate, includes 10% allowance

¹ Spring Retainer

² Special

See Section 4 for seal type description.

03/03/06



Shaft Dia.	Bore Dia.	OD Press Fit Width	*Installed Seal Width	Seal Type	Material	Max. +/- Eccentricity	Parker Part Number
12.250	14.250	0.813	0.813	LUPW	NBR	0.125	16788 H1L5
12.250	14.250	0.813	0.813	LUPW	FKM	0.125	16788 H5L16
12.250	14.250	0.813	0.813	LPDW ¹	FKM	0.150	19104 H5L16
12.250	15.000	0.813	1.162	LUPW ²	NBR	0.400	20580 H1L5
12.250	17.000	0.750	1.114	LPD-EL	NBR	0.144	19907 H1L5
12.375	13.875	0.688	0.688	LUPW	NBR	0.045	16576 H1L5
12.375	13.875	0.688	0.688	LUPW	FKM	0.045	16576 H5L16
12.500	14.500	0.813	0.813	LUPW	NBR	0.045	16577 H1L5
12.500	14.500	0.875	0.875	LUPW	NBR	0.187	16921 H1L5
12.500	14.500	0.875	0.875	LUPW	FKM	0.187	16921 H5L89
12.500	15.000	0.688	10.048	LUPW	NBR	0.145	19986 H1L5
12.500	16.625	0.750	1.125	LUP-EL	NBR	0.563	20441 H1L5
12.688	16.500	0.678	1.133	LPDW ¹	NBR	0.219	17812 H1L5
12.688	16.500	0.688	1.345	LPDW ¹	NBR	0.219	12139 H1L5
13.000	14.500	0.750	0.750	LUPW	NBR	0.125	16678 H1L5
13.000	14.500	0.688	0.688	LUPW	NBR	0.188	16846 H1L5
13.000	14.500	0.688	0.688	LUPW	FKM	0.188	16846 H5L16
13.000	15.000	1.000	1.266	LUPW	NBR	0.300	20427 H1L5
13.000	17.688	1.000	3.817	LUP-EL ²	NBR	0.750	20599 H1L5
13.125	16.375	0.750	1.650	LUP-EL	NBR	0.625	20461 H1L5
13.250	14.750	0.688	0.688	LUPW	NBR	0.045	16579 H1L5
13.500	15.000	0.875	0.875	LUPW	NBR	0.187	19060 H1L5
13.500	15.750	1.000	2.145	LPDW-EL	NBR	0.500	17430 H1L5
13.750	15.750	0.813	0.813	LUPW	NBR	0.075	17887 H1L5
13.750	15.750	0.813	0.813	LUPW	FKM	0.075	17887 H5L16
13.750	17.500	1.000	2.838	LPDW-EL	NBR	0.750	18238 H1L5
13.875	18.000	0.781	1.650	LPDW ¹	NBR	0.320	15290 H1L5
14.000	15.500	0.750	0.750	LUPW ¹	NBR	0.171	15679 H1L5
14.000	16.000	0.750	0.750	RUPW	NBR	0.060	21007 H1L5
14.000	16.250	1.000	1.000	RUPW	NBR	0.062	20452 H1L5
14.250	15.750	0.750	0.750	LUPW	NBR	0.046	17920 H1L5
14.500	16.000	0.688	0.688	LUPW	FKM	0.045	16580 H5L16
14.750	16.250	0.688	0.688	LUPW	NBR	0.048	16581 H1L5
14.750	16.500	0.688	0.688	LUPW	NBR	0.188	16947 H1L5
14.750	16.500	0.688	0.688	LUPW	FKM	0.188	16947 H5L16
15.000	16.500	0.688	0.688	LUPW	NBR	0.048	16582 H1L5
15.000	17.250	0.750	0.750	LUPW ²	NBR	0.156	20479 H1L5
15.000	21.000	0.750	2.440	LUP-EL	NBR	0.950	20470 H1L5
15.352	18.108	1.000	1.000	LUPW	NBR	0.188	19296 H1L5
15.750	17.250	0.688	0.688	LUPW	NBR	0.075	17908 H1L5
15.750	17.250	0.688	0.688	LUPW	FKM	0.075	17908 H5L16
15.750	18.500	0.750	2.131	LPDW	NBR	0.500	17832 H1L5
15.750	18.625	0.875	0.875	LUPW	NBR	0.125	16789 H1L5
15.750	18.625	0.875	0.875	LUPW	FKM	0.125	16789 H5L16
15.813	18.000	0.875	0.875	LPDW	NBR	0.063	10498 H1L5
16.000	18.125	0.875	0.875	LUPW	NBR	0.187	16810 H1L5
16.000	18.125	0.875	0.875	LUPW	FKM	0.187	16810 H5L16
16.000	19.000	1.000	1.870	LUPWEL	NBR	0.455	16891 H1L5
16.000	19.000	1.500	1.870	LUPW-EL	FKM	0.455	16891 H5MX5489
16.000	20.500	1.000	1.000	LPDW	NBR	0.250	12248 H1L5
16.750	19.250	1.125	1.125	RUPW	NBR	0.005	18137 H1L5
16.750	20.188	0.750	2.123	LUP-EL	NBR	0.750	20499 H1L5
16.750	20.188	0.750	3.059	LUP-EL	NBR	0.750	20589 H1L5
17.000	18.500	0.875	0.875	LUPW	NBR	0.125	17919 H1L5
17.000	19.000	0.813	0.813	LUPW	NBR	0.187	16873 H1L5
17.000	19.000	0.813	0.813	LUPW	FKM	0.187	16873 H5L16
17.000	19.000	0.813	0.813	LUPW	NBR	0.250	17040 H1L5
17.000	19.000	0.813	0.813	LUPW	FKM	0.250	17040 H5L16
17.000	19.500	0.875	0.875	LUPW	NBR	0.187	17791 H1L5
17.000	21.500	1.000	2.239	LPDW	NBR	0.562	17436 H1L5

*EL = Extended Lip. Additional housing width required for seal lip to fully operate, includes 10% allowance

¹ Spring Retainer

² Special

See **Section 4** for seal type description.

03/03/06



B

Shaft Dia.	Bore Dia.	OD Press Fit Width	*Installed Seal Width	Seal Type	Material	Max. +/- Eccentricity	Parker Part Number
18.000	20.000	0.875	0.875	LUPW	NBR	0.187	16876 H1L5
18.000	20.000	0.875	0.875	LUPW	FKM	0.187	16876 H5L16
18.000	22.500	1.000	2.090	LPDW ¹	NBR	0.375	15091 H1L5
18.250	21.250	2.000	2.063	RPDEL ²	NBR	0.005	17268 H1L5
18.500	20.000	0.750	0.750	LUPW	NBR	0.187	19796 H1L5
18.500	20.000	0.750	0.750	LUPW	FKM	0.187	19796 H5L16
18.500	20.500	0.875	0.875	LUPW	XNBR	0.188	16981 H1L20
18.500	20.500	0.875	0.875	LUPW	NBR	0.188	16981 H1L5
18.500	20.500	0.875	0.875	LUPW	FKM	0.188	16981 H5L16
18.500	23.000	1.000	2.338	LPDW ¹	NBR	0.653	18041 H1L5
18.850	22.150	0.750	0.750	LUPEL	NBR	0.315	20660 H1L5
19.000	21.000	0.750	0.750	LUPW	NBR	0.187	16835 H1L5
19.000	21.000	0.750	0.750	LUPW	FKM	0.187	16835 H5L16
19.250	21.250	0.750	0.750	RUPW	NBR	0.005	17703 H1L5
19.500	21.500	0.875	0.875	LUPW	NBR	0.045	16380 H1L5
19.500	21.500	0.875	0.875	LUPW	NBR	0.045	16380 H1L70
20.000	23.188	0.750	2.338	LUP-EL	NBR	0.750	20560 H1L5
20.875	22.875	.812	.812	RUPW	NBR	0.005	17384 H1L5
21.000	23.000	0.750	0.750	RUPW	NBR	0.051	20421 H1L5
22.250	26.250	1.000	1.925	LPDW	NBR	0.375	19757 H1L5
22.500	24.500	0.875	0.875	LUPW	NBR	0.048	16585 H1L5
22.750	28.500	1.250	2.404	LPDW ¹	NBR	0.607	18000 H1L5
23.000	25.375	0.875	0.875	LUPW	NBR	0.187	16874 H1L5
23.000	25.375	0.875	0.875	LUPW	FKM	0.187	16874 H5L16
23.250	23.750	1.000	1.000	RUPW	NBR	0.005	16689 H1L5
23.250	23.750	1.000	1.000	RUPW	NBR	0.005	16689-S H1L5
23.500	26.375	1.000	1.000	LUPW	NBR	0.188	16811 H1L5
24.500	31.125	0.750	5.466	LUP-EL ²	FKM	0.750	20584 H5MX5489
25.000	27.000	1.000	1.000	RUPW	NBR	0.005	17138 H1L5
25.000	27.375	0.875	0.875	LUPW	NBR	0.187	16836 H1L5
25.000	27.375	0.875	0.875	LUPW	FKM	0.188	16836 H5L16
25.000	27.500	0.875	1.870	LUPW-EL	NBR	0.437	16890 H1L5
25.000	27.500	0.875	0.875	LPDW ¹	NBR	0.190	13353 H1L5
25.740	28.250	1.250	1.250	RUPW	NBR	0.125	19313 H1L5
25.742	28.250	1.250	1.250	RUPW	H1L3	0.094	17042 H1L3
25.742	28.250	1.250	1.250	RUPW	NBR	0.094	17042 H1L5
25.750	31.000	0.750	2.132	LUP-EL	NBR	0.750	20448 H1L5
25.750	31.000	0.750	2.132	LUP-EL	FKM	0.750	20448 H5L16
25.875	28.875	1.000	1.000	RUPW	NBR	0.188	19357 H1L5
26.000	28.000	1.000	1.000	RUPW	NBR	0.005	18101 H1L5
26.625	28.625	1.000	1.000	RUPW	NBR	0.005	17974 H1L5
28.000	30.500	1.000	1.000	LPDW	NBR	0.187	13352 H1L5
28.370	32.375	0.500	1.045	RUPW	NBR	0.005	17242 H1L5
29.000	31.000	1.000	1.000	RUPW	NBR	0.094	16340 H1L5
29.000	31.000	1.000	1.000	RUPW	FKM	0.094	16340 H5L16
29.000	31.375	1.000	1.000	RUPW	NBR	0.094	16493 H1L5
31.625	33.625	1.000	1.000	RUPW	NBR	0.094	16339 H1L5
33.500	36.000	0.875	0.875	LUPW ¹	NBR	0.060	15720 H1L5
33.870	35.870	1.400	1.400	RUPW	NBR	0.156	19263 H1L5
34.875	37.375	1.000	1.000	RUPW	NBR	0.005	17633 H1L5
38.250	40.250	1.000	1.000	RUPW	NBR	0.005	19237 H1L5
39.625	41.562	1.000	1.000	RUPW	NBR	0.005	18258 H1L5
43.870	46.875	1.250	1.250	RUPW	NBR	0.005	17128 H1L5
43.875	46.375	1.250	1.250	RUPW	NBR	0.005	17127 H1L5

*EL = Extended Lip. Additional housing width required for seal lip to fully operate, includes 10% allowance

¹ Spring Retainer

² Special

See Section 4 for seal type description.

03/03/06



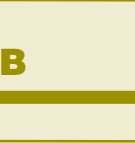

Gland Dimensions — FC and FH Profiles

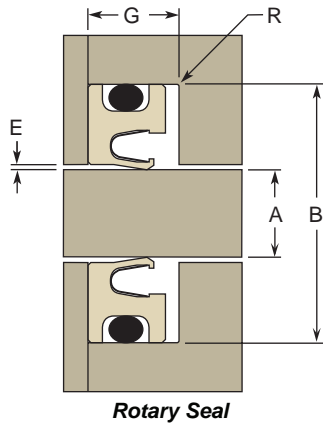

FC part numbers are available only in 125 (1/8") cross-section and higher.

FH part numbers are available in extended heel option only.

Dash #	A Shaft Diameter	B Groove Diameter	Part Number
--------	------------------	-------------------	-------------

R = 0.015" max. radius
 E = 0.002" max.
 G for Extended heel groove = 0.149/0.159" (140 callout)

	+0.001/ -0.001	+0.001/ -0.000	
-006	0.125	0.250	xxxxFHx06200125140xxx
-007	0.156	0.281	xxxxFHx06200156140xxx
-008	0.187	0.312	xxxxFHx06200187140xxx
-009	0.218	0.343	xxxxFHx06200218140xxx
-010	0.250	0.375	xxxxFHx06200250140xxx
-011	0.312	0.437	xxxxFHx06200312140xxx
-012	0.375	0.500	xxxxFHx06200375140xxx
-013	0.437	0.562	xxxxFHx06200437140xxx
-014	0.500	0.625	xxxxFHx06200500140xxx
-015	0.562	0.687	xxxxFHx06200562140xxx
-016	0.625	0.750	xxxxFHx06200625140xxx
-017	0.687	0.812	xxxxFHx06200687140xxx
-018	0.750	0.875	xxxxFHx06200750140xxx
-019	0.812	0.937	xxxxFHx06200812140xxx
-020	0.875	1.000	xxxxFHx06200875140xxx
-021	0.937	1.062	xxxxFHx06200937140xxx
-022	1.000	1.125	xxxxFHx06201000140xxx
-023	1.062	1.187	xxxxFHx06201062140xxx
-024	1.125	1.250	xxxxFHx06201125140xxx
-025	1.187	1.312	xxxxFHx06201187140xxx

Dash #	A Shaft Diameter	B Groove Diameter	Part Number
-026	1.250	1.375	xxxxFHx06201250140xxx
-027	1.312	1.437	xxxxFHx06201312140xxx
-028	1.375	1.500	xxxxFHx06201375140xxx
-029	1.500	1.625	xxxxFHx06201500140xxx
-030	1.625	1.750	xxxxFHx06201625140xxx
-031	1.750	1.875	xxxxFHx06201750140xxx
-032	1.875	2.000	xxxxFHx06201875140xxx
-033	2.000	2.125	xxxxFHx06202000140xxx
-034	2.125	2.250	xxxxFHx06202125140xxx
-035	2.250	2.375	xxxxFHx06202250140xxx
-036	2.375	2.500	xxxxFHx06202375140xxx
-037	2.500	2.625	xxxxFHx06202500140xxx
-038	2.625	2.750	xxxxFHx06202625140xxx
-039	2.750	2.875	xxxxFHx06202750140xxx
-040	2.875	3.000	xxxxFHx06202875140xxx
-041	3.000	3.125	xxxxFHx06203000140xxx
-042	3.250	3.375	xxxxFHx06203250140xxx
-043	3.500	3.625	xxxxFHx06203500140xxx
-044	3.750	3.875	xxxxFHx06203750140xxx
-045	4.000	4.125	xxxxFHx06204000140xxx

R = 0.015" max. radius
 E = 0.002" max.
 G for Extended heel groove = 0.183/0.193" (165 callout)

	+0.001/ -0.002	+0.002/ -0.000	
-106	0.187	0.375	xxxxFHx09300187165xxx
-107	0.219	0.406	xxxxFHx09300219165xxx
-108	0.250	0.437	xxxxFHx09300250165xxx
-109	0.312	0.500	xxxxFHx09300312165xxx
-110	0.375	0.562	xxxxFHx09300375165xxx
-111	0.437	0.625	xxxxFHx09300437165xxx
-112	0.500	0.687	xxxxFHx09300500165xxx
-113	0.562	0.750	xxxxFHx09300562165xxx
-114	0.625	0.812	xxxxFHx09300625165xxx
-115	0.687	0.875	xxxxFHx09300687165xxx
-116	0.750	0.937	xxxxFHx09300750165xxx
-117	0.812	1.000	xxxxFHx09300812165xxx
-118	0.875	1.062	xxxxFHx09300875165xxx
-119	0.937	1.125	xxxxFHx09300937165xxx
-120	1.000	1.187	xxxxFHx09301000165xxx
-121	1.062	1.250	xxxxFHx09301062165xxx
-122	1.125	1.312	xxxxFHx09301125165xxx
-123	1.187	1.375	xxxxFHx09301187165xxx
-124	1.250	1.437	xxxxFHx09301250165xxx
-125	1.312	1.500	xxxxFHx09301312165xxx

See Section 4 for seal type description.

03/03/06



B

Dash #	A Shaft Diameter	B Groove Diameter	Part Number
--------	------------------	-------------------	-------------

R = 0.015" max. radius
 E = 0.002" max.
 G for Extended heel groove = 0.183/0.193" (165 callout)

	+0.00/ -0.02	+0.02/ -0.00	
-126	1.375	1.562	xxxxFHx09301375165xxx
-127	1.437	1.625	xxxxFHx09301437165xxx
-128	1.500	1.687	xxxxFHx09301500165xxx
-129	1.562	1.750	xxxxFHx09301562165xxx
-130	1.625	1.812	xxxxFHx09301625165xxx
-131	1.687	1.875	xxxxFHx09301687165xxx
-132	1.750	1.937	xxxxFHx09301750165xxx
-133	1.812	2.000	xxxxFHx09301812165xxx
-134	1.875	2.062	xxxxFHx09301875165xxx
-135	1.937	2.125	xxxxFHx09301937165xxx
-136	2.000	2.187	xxxxFHx09302000165xxx
-137	2.062	2.250	xxxxFHx09302062165xxx
-138	2.125	2.312	xxxxFHx09302125165xxx
-139	2.187	2.375	xxxxFHx09302187165xxx
-140	2.250	2.437	xxxxFHx09302250165xxx
-141	2.312	2.500	xxxxFHx09302312165xxx
-142	2.375	2.562	xxxxFHx09302375165xxx
-143	2.437	2.625	xxxxFHx09302437165xxx
-144	2.500	2.687	xxxxFHx09302500165xxx
-145	2.562	2.750	xxxxFHx09302562165xxx
-146	2.625	2.812	xxxxFHx09302625165xxx
-147	2.687	2.875	xxxxFHx09302687165xxx
-148	2.750	2.937	xxxxFHx09302750165xxx
-149	2.812	3.000	xxxxFHx09302812165xxx
-150	2.875	3.062	xxxxFHx09302875165xxx
-151	3.000	3.187	xxxxFHx09303000165xxx
-152	3.250	3.437	xxxxFHx09303250165xxx
-153	3.500	3.687	xxxxFHx09303500165xxx
-154	3.750	3.937	xxxxFHx09303750165xxx
-155	4.000	4.187	xxxxFHx09304000165xxx
-156	4.250	4.437	xxxxFHx09304250165xxx
-157	4.500	4.687	xxxxFHx09304500165xxx
-158	4.750	4.937	xxxxFHx09304750165xxx
-159	5.000	5.187	xxxxFHx09305000165xxx
-160	5.250	5.437	xxxxFHx09305250165xxx
-161	5.500	5.687	xxxxFHx09305500165xxx
-162	5.750	5.928	xxxxFHx09305750165xxx
-163	6.000	6.187	xxxxFHx09306000165xxx

R = 0.015" max. radius
 E = 0.002" max.
 G for Standard heel groove = 0.188/0.198" (160 callout)
 G for Extended heel groove = 0.235/0.245" (220 callout)

	+0.00/ -0.02	+0.02/ -0.00	
-202	0.250	0.500	xxxxFCx12500250160xxx
-203	0.312	0.562	xxxxFCx12500312160xxx
-204	0.375	0.625	xxxxFCx12500375160xxx
-205	0.437	0.687	xxxxFCx12500437160xxx

Dash #	A Shaft Diameter	B Groove Diameter	Part Number
-206	0.500	0.750	xxxxFCx12500500160xxx
-207	0.562	0.812	xxxxFCx12500562160xxx
-208	0.625	0.875	xxxxFCx12500625160xxx
-209	0.687	0.937	xxxxFCx12500687160xxx
-210	0.750	1.000	xxxxFCx12500750160xxx
-211	0.812	1.062	xxxxFCx12500812160xxx
-212	0.875	1.125	xxxxFCx12500875160xxx
-213	0.937	1.187	xxxxFCx12500937160xxx
-214	1.000	1.250	xxxxFCx12501000160xxx
-215	1.062	1.312	xxxxFCx12501062160xxx
-216	1.125	1.375	xxxxFCx12501125160xxx
-217	1.187	1.437	xxxxFCx12501187160xxx
-218	1.250	1.500	xxxxFCx12501250160xxx
-219	1.312	1.562	xxxxFCx12501312160xxx
-220	1.375	1.625	xxxxFCx12501375160xxx
-221	1.437	1.687	xxxxFCx12501437160xxx
-222	1.500	1.750	xxxxFCx12501500160xxx
-223	1.625	1.875	xxxxFCx12501625160xxx
-224	1.750	2.000	xxxxFCx12501750160xxx
-225	1.875	2.125	xxxxFCx12501875160xxx
-226	2.000	2.250	xxxxFCx12502000160xxx
-227	2.125	2.375	xxxxFCx12502125160xxx
-228	2.250	2.500	xxxxFCx12502250160xxx
-229	2.375	2.625	xxxxFCx12502375160xxx
-230	2.500	2.750	xxxxFCx12502500160xxx
-231	2.625	2.875	xxxxFCx12502625160xxx
-232	2.750	3.000	xxxxFCx12502750160xxx
-233	2.875	3.125	xxxxFCx12502875160xxx
-234	3.000	3.250	xxxxFCx12503000160xxx
-235	3.125	3.375	xxxxFCx12503125160xxx
-236	3.250	3.500	xxxxFCx12503250160xxx
-237	3.375	3.625	xxxxFCx12503375160xxx
-238	3.500	3.750	xxxxFCx12503500160xxx
-239	3.625	3.875	xxxxFCx12503625160xxx
-240	3.750	4.000	xxxxFCx12503750160xxx
-241	3.875	4.125	xxxxFCx12503875160xxx
-242	4.000	4.250	xxxxFCx12504000160xxx
-243	4.125	4.375	xxxxFCx12504125160xxx
-244	4.250	4.500	xxxxFCx12504250160xxx
-245	4.375	4.625	xxxxFCx12504375160xxx
-246	4.500	4.750	xxxxFCx12504500160xxx
-247	4.625	4.875	xxxxFCx12504625160xxx
-248	4.750	5.000	xxxxFCx12504750160xxx
-249	4.875	5.125	xxxxFCx12504875160xxx
-250	5.000	5.250	xxxxFCx12505000160xxx
-251	5.125	5.375	xxxxFCx12505125160xxx
-252	5.250	5.500	xxxxFCx12505250160xxx
-253	5.375	5.625	xxxxFCx12505375160xxx
-254	5.500	5.750	xxxxFCx12505500160xxx
-255	5.625	5.875	xxxxFCx12505625160xxx
-256	5.750	6.000	xxxxFCx12505750160xxx
-257	5.875	6.125	xxxxFCx12505875160xxx

See Section 4 for seal type description.

03/03/06



B

Dash #	A Shaft Diameter	B Groove Diameter	Part Number
--------	------------------	-------------------	-------------

R = 0.015" max. radius
 E = 0.002" max.
 G for Standard heel groove = 0.188/0.198" (160 callout)
 G for Extended heel groove = 0.235/0.245" (220 callout)

	+0.000/ -0.002	+0.002/ -0.000	
-258	6.000	6.250	xxxxFCx12506000160xxx
-259	6.250	6.500	xxxxFCx12506250160xxx
-260	6.500	6.750	xxxxFCx12506500160xxx
-261	6.750	7.000	xxxxFCx12506750160xxx
-262	7.000	7.250	xxxxFCx12507000160xxx
-263	7.250	7.500	xxxxFCx12507250160xxx
-264	7.500	7.750	xxxxFCx12507500160xxx
-265	7.750	8.000	xxxxFCx12507750160xxx
-266	8.000	8.250	xxxxFCx12508000160xxx
-267	8.250	8.500	xxxxFCx12508250160xxx
-268	8.500	8.750	xxxxFCx12508500160xxx
-269	8.750	9.000	xxxxFCx12508750160xxx
-270	9.000	9.250	xxxxFCx12509000160xxx
-271	9.250	9.500	xxxxFCx12509250160xxx
-272	9.500	9.750	xxxxFCx12509500160xxx
-273	9.750	10.000	xxxxFCx12509750160xxx
-274	10.000	10.250	xxxxFCx12510000160xxx
-275	10.500	10.750	xxxxFCx12510500160xxx
-276	11.000	11.250	xxxxFCx12511000160xxx
-277	11.500	11.750	xxxxFCx12511500160xxx
-278	12.000	12.250	xxxxFCx12512000160xxx
-279	12.500	12.750	xxxxFCx12512500160xxx
-280	13.000	13.250	xxxxFCx12513000160xxx
-281	13.500	13.750	xxxxFCx12513500160xxx

R = 0.015" max. radius
 E = 0.003" max.
 G for Standard heel groove = 0.281/0.291" (260 callout)
 G for Extended heel groove = 0.334/0.344" (310 callout)

	+0.000/ -0.002	+0.002/ -0.000	
-310	0.500	0.875	xxxxFCx18700500260xxx
-311	0.562	0.937	xxxxFCx18700562260xxx
-312	0.625	1.000	xxxxFCx18700625260xxx
-313	0.687	1.062	xxxxFCx18700687260xxx
-314	0.750	1.125	xxxxFCx18700750260xxx
-315	0.812	1.187	xxxxFCx18700812260xxx
-316	0.875	1.250	xxxxFCx18700875260xxx
-317	0.937	1.312	xxxxFCx18700937260xxx
-318	1.000	1.375	xxxxFCx18701000260xxx
-319	1.062	1.437	xxxxFCx18701062260xxx
-320	1.125	1.500	xxxxFCx18701125260xxx
-321	1.187	1.562	xxxxFCx18701187260xxx
-322	1.250	1.625	xxxxFCx18701250260xxx
-323	1.312	1.687	xxxxFCx18701312260xxx
-324	1.375	1.750	xxxxFCx18701375260xxx
-325	1.500	1.875	xxxxFCx18701500260xxx
-326	1.625	2.000	xxxxFCx18701625260xxx
-327	1.750	2.125	xxxxFCx18701750260xxx

Dash #	A Shaft Diameter	B Groove Diameter	Part Number
-328	1.875	2.250	xxxxFCx18701875260xxx
-329	2.000	2.375	xxxxFCx18702000260xxx
-330	2.125	2.500	xxxxFCx18702125260xxx
-331	2.250	2.625	xxxxFCx18702250260xxx
-332	2.375	2.750	xxxxFCx18702375260xxx
-333	2.500	2.875	xxxxFCx18702500260xxx
-334	2.625	3.000	xxxxFCx18702625260xxx
-335	2.750	3.125	xxxxFCx18702750260xxx
-336	2.875	3.250	xxxxFCx18702875260xxx
-337	3.000	3.375	xxxxFCx18703000260xxx
-338	3.125	3.500	xxxxFCx18703125260xxx
-339	3.250	3.625	xxxxFCx18703250260xxx
-340	3.375	3.750	xxxxFCx18703375260xxx
-341	3.500	3.875	xxxxFCx18703500260xxx
-342	3.625	4.000	xxxxFCx18703625260xxx
-343	3.750	4.125	xxxxFCx18703750260xxx
-344	3.875	4.250	xxxxFCx18703875260xxx
-345	4.000	4.375	xxxxFCx18704000260xxx
-346	4.125	4.500	xxxxFCx18704125260xxx
-347	4.250	4.625	xxxxFCx18704250260xxx
-348	4.375	4.750	xxxxFCx18704375260xxx
-349	4.500	4.875	xxxxFCx18704500260xxx
-350	4.625	5.000	xxxxFCx18704625260xxx
-351	4.750	5.125	xxxxFCx18704750260xxx
-352	4.875	5.250	xxxxFCx18704875260xxx
-353	5.000	5.375	xxxxFCx18705000260xxx
-354	5.125	5.500	xxxxFCx18705125260xxx
-355	5.250	5.625	xxxxFCx18705250260xxx
-356	5.375	5.750	xxxxFCx18705375260xxx
-357	5.500	5.875	xxxxFCx18705500260xxx
-358	5.625	6.000	xxxxFCx18705625260xxx
-359	5.750	6.125	xxxxFCx18705750260xxx
-360	5.875	6.250	xxxxFCx18705875260xxx
-361	6.000	6.375	xxxxFCx18706000260xxx
-362	6.250	6.625	xxxxFCx18706250260xxx
-363	6.500	6.875	xxxxFCx18706500260xxx
-364	6.750	7.125	xxxxFCx18706750260xxx
-365	7.000	7.375	xxxxFCx18707000260xxx
-366	7.250	7.625	xxxxFCx18707250260xxx
-367	7.500	7.875	xxxxFCx18707500260xxx
-368	7.750	8.125	xxxxFCx18707750260xxx
-369	8.000	8.375	xxxxFCx18708000260xxx
-370	8.250	8.625	xxxxFCx18708250260xxx
-371	8.500	8.875	xxxxFCx18708500260xxx
-372	8.750	9.125	xxxxFCx18708750260xxx
-373	9.000	9.375	xxxxFCx18709000260xxx
-374	9.250	9.625	xxxxFCx18709250260xxx
-375	9.500	9.875	xxxxFCx18709500260xxx
-376	9.750	10.125	xxxxFCx18709750260xxx
-377	10.000	10.375	xxxxFCx18710000260xxx
-378	10.500	10.875	xxxxFCx18710500260xxx
-379	11.000	11.375	xxxxFCx18711000260xxx

See Section 4 for seal type description.

03/03/06



B

Dash #	A Shaft Diameter	B Groove Diameter	Part Number
--------	------------------	-------------------	-------------

R = 0.015" max. radius
 E = 0.003" max.
 G for Standard heel groove = 0.281/0.291" (260 callout)
 G for Extended heel groove = 0.334/0.344" (310 callout)

	+ .000/ - .002	+ .002/ - .000	
-380	11.500	11.875	xxxxFCx18711500260xxx
-381	12.000	12.375	xxxxFCx18712000260xxx
-382	13.000	13.375	xxxxFCx18713000260xxx
-383	14.000	14.375	xxxxFCx18714000260xxx
-384	15.000	15.375	xxxxFCx18715000260xxx
-385	16.000	16.375	xxxxFCx18716000260xxx
-386	17.000	17.375	xxxxFCx18717000260xxx
-387	18.000	18.375	xxxxFCx18718000260xxx
-388	19.000	19.375	xxxxFCx18719000260xxx
-389	20.000	20.375	xxxxFCx18720000260xxx
-390	21.000	21.375	xxxxFCx18721000260xxx
-391	22.000	22.375	xxxxFCx18722000260xxx
-392	23.000	23.375	xxxxFCx18723000260xxx
-393	24.000	24.375	xxxxFCx18724000260xxx
-394	25.000	25.375	xxxxFCx18725000260xxx
-395	26.000	26.375	xxxxFCx18726000260xxx

R = 0.015" max. radius
 E = 0.003" max.
 G for Standard heel groove = 0.375/0.385" (355 callout)
 G for Extended heel groove = 0.475/0.485" (450 callout)

	+ .000/ - .003	+ .003/ - .000	
-401	1.500	2.000	xxxxFCx25001500355xxx
-402	1.625	2.125	xxxxFCx25001625355xxx
-403	1.750	2.250	xxxxFCx25001750355xxx
-404	1.875	2.375	xxxxFCx25001875355xxx
-405	2.000	2.500	xxxxFCx25002000355xxx
-406	2.125	2.625	xxxxFCx25002125355xxx
-407	2.250	2.750	xxxxFCx25002250355xxx
-408	2.375	2.875	xxxxFCx25002375355xxx
-409	2.500	3.000	xxxxFCx25002500355xxx
-410	2.625	3.125	xxxxFCx25002625355xxx
-411	2.750	3.250	xxxxFCx25002750355xxx
-412	2.875	3.375	xxxxFCx25002875355xxx
-413	3.000	3.500	xxxxFCx25003000355xxx
-414	3.125	3.625	xxxxFCx25003125355xxx
-415	3.250	3.750	xxxxFCx25003250355xxx
-416	3.375	3.875	xxxxFCx25003375355xxx
-417	3.500	4.000	xxxxFCx25003500355xxx
-418	3.625	4.125	xxxxFCx25003625355xxx
-419	3.750	4.250	xxxxFCx25003750355xxx
-420	3.875	4.375	xxxxFCx25003875355xxx
-421	4.000	4.500	xxxxFCx25004000355xxx
-422	4.125	4.625	xxxxFCx25004125355xxx
-423	4.250	4.750	xxxxFCx25004250355xxx
-424	4.375	4.875	xxxxFCx25004375355xxx
-425	4.500	5.000	xxxxFCx25004500355xxx
-426	4.625	5.125	xxxxFCx25004625355xxx

Dash #	A Shaft Diameter	B Groove Diameter	Part Number
-427	4.750	5.250	xxxxFCx25004750355xxx
-428	4.875	5.375	xxxxFCx25004875355xxx
-429	5.000	5.500	xxxxFCx25005000355xxx
-430	5.125	5.625	xxxxFCx25005125355xxx
-431	5.250	5.750	xxxxFCx25005250355xxx
-432	5.375	5.875	xxxxFCx25005375355xxx
-433	5.500	6.000	xxxxFCx25005500355xxx
-434	5.625	6.125	xxxxFCx25005625355xxx
-435	5.750	6.250	xxxxFCx25005750355xxx
-436	5.875	6.375	xxxxFCx25005875355xxx
-437	6.000	6.500	xxxxFCx25006000355xxx
-438	6.250	6.750	xxxxFCx25006250355xxx
-439	6.500	7.000	xxxxFCx25006500355xxx
-440	6.750	7.250	xxxxFCx25006750355xxx
-441	7.000	7.500	xxxxFCx25007000355xxx
-442	7.250	7.750	xxxxFCx25007250355xxx
-443	7.500	8.000	xxxxFCx25007500355xxx
-444	7.750	8.250	xxxxFCx25007750355xxx
-445	8.000	8.500	xxxxFCx25008000355xxx
-446	8.500	9.000	xxxxFCx25008500355xxx
-447	9.000	9.500	xxxxFCx25009000355xxx
-448	9.500	10.000	xxxxFCx25009500355xxx
-449	10.000	10.500	xxxxFCx25010000355xxx
-450	10.500	11.000	xxxxFCx25010500355xxx
-451	11.000	11.500	xxxxFCx25011000355xxx
-452	11.500	12.000	xxxxFCx25011500355xxx
-453	12.000	12.500	xxxxFCx25012000355xxx
-454	12.500	13.000	xxxxFCx25012500355xxx
-455	13.000	13.500	xxxxFCx25013000355xxx
-456	13.500	14.000	xxxxFCx25013500355xxx
-457	14.000	14.500	xxxxFCx25014000355xxx
-458	14.500	15.000	xxxxFCx25014500355xxx
-459	15.000	15.500	xxxxFCx25015000355xxx
-460	15.500	16.000	xxxxFCx25015500355xxx
-461	16.000	16.500	xxxxFCx25016000355xxx
-462	16.500	17.000	xxxxFCx25016500355xxx
-463	17.000	17.500	xxxxFCx25017000355xxx
-464	17.500	18.000	xxxxFCx25017500355xxx
-465	18.000	18.500	xxxxFCx25018000355xxx
-466	18.500	19.000	xxxxFCx25018500355xxx
-467	19.000	19.500	xxxxFCx25019000355xxx
-468	19.500	20.000	xxxxFCx25019500355xxx
-469	20.000	20.500	xxxxFCx25020000355xxx
-470	21.000	21.500	xxxxFCx25021000355xxx
-471	22.000	22.500	xxxxFCx25022000355xxx
-472	23.000	23.500	xxxxFCx25023000355xxx
-473	24.000	24.500	xxxxFCx25024000355xxx
-474	25.000	25.500	xxxxFCx25025000355xxx
-475	26.000	26.500	xxxxFCx25026000355xxx

See Section 4 for seal type description.

03/03/06



Gland Dimensions — FF Profiles, Flanged

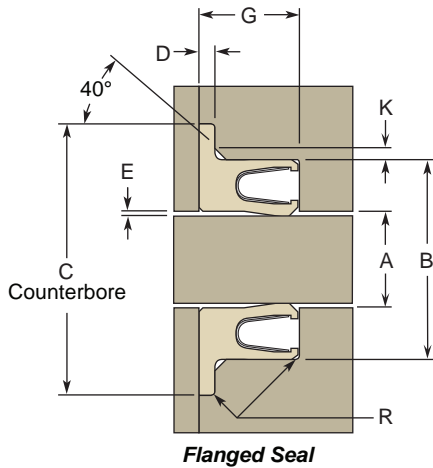

Dash #	A Shaft Dia.	B Groove Dia.	C Flange C-Bore Dia. Min.	Part Number
--------	--------------	---------------	---------------------------	-------------

R = 0.015" max. radius
 E = 0.002" max. K = 0.017" Ref.
 G for Standard heel groove = 0.094/0.104" (083 callout)
 D Gland Counterbore depth for seal flange = 0.011/0.013"

	+0.00/ -0.02	+0.02/ -0.00		
-006	0.125	0.250	0.400	xxxxFFx06200125083xxx
-007	0.156	0.281	0.431	xxxxFFx06200156083xxx
-008	0.187	0.312	0.462	xxxxFFx06200187083xxx
-009	0.218	0.343	0.493	xxxxFFx06200218083xxx
-010	0.250	0.375	0.525	xxxxFFx06200250083xxx
-011	0.312	0.437	0.587	xxxxFFx06200312083xxx
-012	0.375	0.500	0.650	xxxxFFx06200375083xxx
-013	0.437	0.562	0.712	xxxxFFx06200437083xxx
-014	0.500	0.625	0.775	xxxxFFx06200500083xxx
-015	0.562	0.687	0.837	xxxxFFx06200562083xxx
-016	0.625	0.750	0.900	xxxxFFx06200625083xxx
-017	0.687	0.812	0.962	xxxxFFx06200687083xxx
-018	0.750	0.875	1.025	xxxxFFx06200750083xxx
-019	0.812	0.937	1.087	xxxxFFx06200812083xxx
-020	0.875	1.000	1.150	xxxxFFx06200875083xxx
-021	0.937	1.062	1.212	xxxxFFx06200937083xxx
-022	1.000	1.125	1.275	xxxxFFx06201000083xxx
-023	1.062	1.187	1.337	xxxxFFx06201062083xxx
-024	1.125	1.250	1.400	xxxxFFx06201125083xxx
-025	1.187	1.312	1.462	xxxxFFx06201187083xxx
-026	1.250	1.375	1.525	xxxxFFx06201250083xxx
-027	1.312	1.437	1.587	xxxxFFx06201312083xxx
-028	1.375	1.500	1.650	xxxxFFx06201375083xxx
-029	1.500	1.625	1.775	xxxxFFx06201500083xxx
-030	1.625	1.750	1.900	xxxxFFx06201625083xxx
-031	1.750	1.875	2.025	xxxxFFx06201750083xxx
-032	1.875	2.000	2.150	xxxxFFx06201875083xxx
-033	2.000	2.125	2.275	xxxxFFx06202000083xxx

See Section 4 for seal type description.

Dash #	A Shaft Dia.	B Groove Dia.	C Flange C-Bore Dia. Min.	Part Number
-034	2.125	2.250	2.400	xxxxFFx06202125083xxx
-035	2.250	2.375	2.525	xxxxFFx06202250083xxx
-036	2.375	2.500	2.650	xxxxFFx06202375083xxx
-037	2.500	2.625	2.775	xxxxFFx06202500083xxx
-038	2.625	2.750	2.900	xxxxFFx06202625083xxx
-039	2.750	2.875	3.025	xxxxFFx06202750083xxx
-040	2.875	3.000	3.150	xxxxFFx06202875083xxx
-041	3.000	3.125	3.275	xxxxFFx06203000083xxx
-042	3.250	3.375	3.525	xxxxFFx06203250083xxx
-043	3.500	3.625	3.775	xxxxFFx06203500083xxx
-044	3.750	3.875	4.025	xxxxFFx06203750083xxx
-045	4.000	4.125	4.275	xxxxFFx06204000083xxx

R = 0.015" max. radius
 E = 0.002" max. K = 0.028" Ref.
 G for Standard heel groove = 0.141/0.151" (130 callout)
 D Gland Counterbore depth for seal flange = 0.017/0.020"

	+0.00/ -0.02	+0.02/ -0.00		
-106	0.187	0.375	0.530	xxxxFFx09300187130xxx
-107	0.219	0.406	0.561	xxxxFFx09300219130xxx
-108	0.250	0.437	0.592	xxxxFFx09300250130xxx
-109	0.312	0.500	0.655	xxxxFFx09300312130xxx
-110	0.375	0.562	0.717	xxxxFFx09300375130xxx
-111	0.437	0.625	0.780	xxxxFFx09300437130xxx
-112	0.500	0.687	0.842	xxxxFFx09300500130xxx
-113	0.562	0.750	0.905	xxxxFFx09300562130xxx
-114	0.625	0.812	0.967	xxxxFFx09300625130xxx
-115	0.687	0.875	1.030	xxxxFFx09300687130xxx
-116	0.750	0.937	1.092	xxxxFFx09300750130xxx
-117	0.812	1.000	1.155	xxxxFFx09300812130xxx
-118	0.875	1.062	1.217	xxxxFFx09300875130xxx
-119	0.937	1.125	1.280	xxxxFFx09300937130xxx
-120	1.000	1.187	1.342	xxxxFFx09301000130xxx
-121	1.062	1.250	1.405	xxxxFFx09301062130xxx
-122	1.125	1.312	1.467	xxxxFFx09301125130xxx
-123	1.187	1.375	1.530	xxxxFFx09301187130xxx
-124	1.250	1.437	1.592	xxxxFFx09301250130xxx
-125	1.312	1.500	1.655	xxxxFFx09301312130xxx
-126	1.375	1.562	1.717	xxxxFFx09301375130xxx
-127	1.437	1.625	1.780	xxxxFFx09301437130xxx
-128	1.500	1.687	1.842	xxxxFFx09301500130xxx
-129	1.562	1.750	1.905	xxxxFFx09301562130xxx
-130	1.625	1.812	1.967	xxxxFFx09301625130xxx
-131	1.687	1.875	2.030	xxxxFFx09301687130xxx
-132	1.750	1.937	2.092	xxxxFFx09301750130xxx
-133	1.812	2.000	2.155	xxxxFFx09301812130xxx
-134	1.875	2.062	2.217	xxxxFFx09301875130xxx
-135	1.937	2.125	2.280	xxxxFFx09301937130xxx
-136	2.000	2.187	2.342	xxxxFFx09302000130xxx
-137	2.062	2.250	2.405	xxxxFFx09302062130xxx

03/03/06

B

Dash #	A Shaft Dia.	B Groove Dia.	C Flange C-Bore Dia. Min.	Part Number
--------	--------------	---------------	---------------------------	-------------

R = 0.015" max. radius
 E = 0.002" max. K = 0.028" Ref.
 G for Standard heel groove = 0.141/0.151" (130 callout)
 D Gland Counterbore depth for seal flange = 0.017/0.020"

	+0.00/-0.002	+0.002/-0.000		
-138	2.125	2.312	2.467	xxxxFFx09302125130xxx
-139	2.187	2.375	2.530	xxxxFFx09302187130xxx
-140	2.250	2.437	2.592	xxxxFFx09302250130xxx
-141	2.312	2.500	2.655	xxxxFFx09302312130xxx
-142	2.375	2.562	2.717	xxxxFFx09302375130xxx
-143	2.437	2.625	2.780	xxxxFFx09302437130xxx
-144	2.500	2.687	2.842	xxxxFFx09302500130xxx
-145	2.562	2.750	2.905	xxxxFFx09302562130xxx
-146	2.625	2.812	2.967	xxxxFFx09302625130xxx
-147	2.687	2.875	3.030	xxxxFFx09302687130xxx
-148	2.750	2.937	3.092	xxxxFFx09302750130xxx
-149	2.812	3.000	3.155	xxxxFFx09302812130xxx
-150	2.875	3.062	3.217	xxxxFFx09302875130xxx
-151	3.000	3.187	3.342	xxxxFFx09303000130xxx
-152	3.250	3.437	3.592	xxxxFFx09303250130xxx
-153	3.500	3.687	3.842	xxxxFFx09303500130xxx
-154	3.750	3.937	4.092	xxxxFFx09303750130xxx
-155	4.000	4.187	4.342	xxxxFFx09304000130xxx
-156	4.250	4.437	4.592	xxxxFFx09304250130xxx
-157	4.500	4.687	4.842	xxxxFFx09304500130xxx
-158	4.750	4.937	5.092	xxxxFFx09304750130xxx
-159	5.000	5.187	5.342	xxxxFFx09305000130xxx
-160	5.250	5.437	5.592	xxxxFFx09305250130xxx
-161	5.500	5.687	5.842	xxxxFFx09305500130xxx
-162	5.750	5.928	6.083	xxxxFFx09305750130xxx
-163	6.000	6.187	6.342	xxxxFFx09306000130xxx

R = 0.015" max. radius
 E = 0.002" max. K = 0.040" Ref.
 G for Standard heel groove = 0.188/0.198" (160 callout)
 D Gland Counterbore depth for seal flange = 0.024/0.027"

	+0.00/-0.002	+0.002/-0.000		
-202	0.250	0.500	0.687	xxxxFFx12500250160xxx
-203	0.312	0.562	0.749	xxxxFFx12500312160xxx
-204	0.375	0.625	0.812	xxxxFFx12500375160xxx
-205	0.437	0.687	0.874	xxxxFFx12500437160xxx
-206	0.500	0.750	0.937	xxxxFFx12500500160xxx
-207	0.562	0.812	0.999	xxxxFFx12500562160xxx
-208	0.625	0.875	1.062	xxxxFFx12500625160xxx
-209	0.687	0.937	1.124	xxxxFFx12500687160xxx
-210	0.750	1.000	1.187	xxxxFFx12500750160xxx
-211	0.812	1.062	1.249	xxxxFFx12500812160xxx
-212	0.875	1.125	1.312	xxxxFFx12500875160xxx
-213	0.937	1.187	1.374	xxxxFFx12500937160xxx
-214	1.000	1.250	1.437	xxxxFFx12501000160xxx
-215	1.062	1.312	1.499	xxxxFFx12501062160xxx
-216	1.125	1.375	1.562	xxxxFFx12501125160xxx
-217	1.187	1.437	1.624	xxxxFFx12501187160xxx

Dash #	A Shaft Dia.	B Groove Dia.	C Flange C-Bore Dia. Min.	Part Number
-218	1.250	1.500	1.687	xxxxFFx12501250160xxx
-219	1.312	1.562	1.749	xxxxFFx12501312160xxx
-220	1.375	1.625	1.812	xxxxFFx12501375160xxx
-221	1.437	1.687	1.874	xxxxFFx12501437160xxx
-222	1.500	1.750	1.937	xxxxFFx12501500160xxx
-223	1.625	1.875	2.062	xxxxFFx12501625160xxx
-224	1.750	2.000	2.187	xxxxFFx12501750160xxx
-225	1.875	2.125	2.312	xxxxFFx12501875160xxx
-226	2.000	2.250	2.437	xxxxFFx12502000160xxx
-227	2.125	2.375	2.562	xxxxFFx12502125160xxx
-228	2.250	2.500	2.687	xxxxFFx12502250160xxx
-229	2.375	2.625	2.812	xxxxFFx12502375160xxx
-230	2.500	2.750	2.937	xxxxFFx12502500160xxx
-231	2.625	2.875	3.062	xxxxFFx12502625160xxx
-232	2.750	3.000	3.187	xxxxFFx12502750160xxx
-233	2.875	3.125	3.312	xxxxFFx12502875160xxx
-234	3.000	3.250	3.437	xxxxFFx12503000160xxx
-235	3.125	3.375	3.562	xxxxFFx12503125160xxx
-236	3.250	3.500	3.687	xxxxFFx12503250160xxx
-237	3.375	3.625	3.812	xxxxFFx12503375160xxx
-238	3.500	3.750	3.937	xxxxFFx12503500160xxx
-239	3.625	3.875	4.062	xxxxFFx12503625160xxx
-240	3.750	4.000	4.187	xxxxFFx12503750160xxx
-241	3.875	4.125	4.312	xxxxFFx12503875160xxx
-242	4.000	4.250	4.437	xxxxFFx12504000160xxx
-243	4.125	4.375	4.562	xxxxFFx12504125160xxx
-244	4.250	4.500	4.687	xxxxFFx12504250160xxx
-245	4.375	4.625	4.812	xxxxFFx12504375160xxx
-246	4.500	4.750	4.937	xxxxFFx12504500160xxx
-247	4.625	4.875	5.062	xxxxFFx12504625160xxx
-248	4.750	5.000	5.187	xxxxFFx12504750160xxx
-249	4.875	5.125	5.312	xxxxFFx12504875160xxx
-250	5.000	5.250	5.437	xxxxFFx12505000160xxx
-251	5.125	5.375	5.562	xxxxFFx12505125160xxx
-252	5.250	5.500	5.687	xxxxFFx12505250160xxx
-253	5.375	5.625	5.812	xxxxFFx12505375160xxx
-254	5.500	5.750	5.937	xxxxFFx12505500160xxx
-255	5.625	5.875	6.062	xxxxFFx12505625160xxx
-256	5.750	6.000	6.187	xxxxFFx12505750160xxx
-257	5.875	6.125	6.312	xxxxFFx12505875160xxx
-258	6.000	6.250	6.437	xxxxFFx12506000160xxx
-259	6.250	6.500	6.687	xxxxFFx12506250160xxx
-260	6.500	6.750	6.937	xxxxFFx12506500160xxx
-261	6.750	7.000	7.187	xxxxFFx12506750160xxx
-262	7.000	7.250	7.437	xxxxFFx12507000160xxx
-263	7.250	7.500	7.687	xxxxFFx12507250160xxx
-264	7.500	7.750	7.937	xxxxFFx12507500160xxx
-265	7.750	8.000	8.187	xxxxFFx12507750160xxx
-266	8.000	8.250	8.437	xxxxFFx12508000160xxx
-267	8.250	8.500	8.687	xxxxFFx12508250160xxx

See Section 4 for seal type description.

03/03/06



B

Dash #	A Shaft Dia.	B Groove Dia.	C Flange C-Bore Dia. Min.	Part Number
--------	--------------	---------------	---------------------------	-------------

R = 0.015" max. radius
 E = 0.002" max. K = 0.040" Ref.
 G for Standard heel groove = 0.188/0.198" (160 callout)
 D Gland Counterbore depth for seal flange = 0.024/0.027"

	+0.00/ -.002	+0.002/ -.000		
-268	8.500	8.750	8.937	xxxxFFx12508500160xxx
-269	8.750	9.000	9.187	xxxxFFx12508750160xxx
-270	9.000	9.250	9.437	xxxxFFx12509000160xxx
-271	9.250	9.500	9.687	xxxxFFx12509250160xxx
-272	9.500	9.750	9.937	xxxxFFx12509500160xxx
-273	9.750	10.000	10.187	xxxxFFx12509750160xxx
-274	10.000	10.250	10.437	xxxxFFx12510000160xxx
-275	10.500	10.750	10.937	xxxxFFx12510500160xxx
-276	11.000	11.250	11.437	xxxxFFx12511000160xxx
-277	11.500	11.750	11.937	xxxxFFx12511500160xxx
-278	12.000	12.250	12.437	xxxxFFx12512000160xxx
-279	12.500	12.750	12.937	xxxxFFx12512500160xxx
-280	13.000	13.250	13.437	xxxxFFx12513000160xxx
-281	13.500	13.750	13.937	xxxxFFx12513500160xxx

R = 0.015" max. radius
 E = 0.003" max. K = 0.057" Ref.
 G for Standard heel groove = 0.281/0.291" (260 callout)
 D Gland Counterbore depth for seal flange = 0.028/0.032"

	+0.00/ -.002	+0.002/ -.000		
-310	0.500	0.875	1.166	xxxxFFx18700500260xxx
-311	0.562	0.937	1.228	xxxxFFx18700562260xxx
-312	0.625	1.000	1.291	xxxxFFx18700625260xxx
-313	0.687	1.062	1.353	xxxxFFx18700687260xxx
-314	0.750	1.125	1.416	xxxxFFx18700750260xxx
-315	0.812	1.187	1.478	xxxxFFx18700812260xxx
-316	0.875	1.250	1.541	xxxxFFx18700875260xxx
-317	0.937	1.312	1.603	xxxxFFx18700937260xxx
-318	1.000	1.375	1.666	xxxxFFx18701000260xxx
-319	1.062	1.437	1.728	xxxxFFx18701062260xxx
-320	1.125	1.500	1.791	xxxxFFx18701125260xxx
-321	1.187	1.562	1.853	xxxxFFx18701187260xxx
-322	1.250	1.625	1.916	xxxxFFx18701250260xxx
-323	1.312	1.687	1.978	xxxxFFx18701312260xxx
-324	1.375	1.750	2.041	xxxxFFx18701375260xxx
-325	1.500	1.875	2.166	xxxxFFx18701500260xxx
-326	1.625	2.000	2.291	xxxxFFx18701625260xxx
-327	1.750	2.125	2.416	xxxxFFx18701750260xxx
-328	1.875	2.250	2.541	xxxxFFx18701875260xxx
-329	2.000	2.375	2.666	xxxxFFx18702000260xxx
-330	2.125	2.500	2.791	xxxxFFx18702125260xxx
-331	2.250	2.625	2.916	xxxxFFx18702250260xxx
-332	2.375	2.750	3.041	xxxxFFx18702375260xxx
-333	2.500	2.875	3.166	xxxxFFx18702500260xxx

Dash #	A Shaft Dia.	B Groove Dia.	C Flange C-Bore Dia. Min.	Part Number
-334	2.625	3.000	3.291	xxxxFFx18702625260xxx
-335	2.750	3.125	3.416	xxxxFFx18702750260xxx
-336	2.875	3.250	3.541	xxxxFFx18702875260xxx
-337	3.000	3.375	3.666	xxxxFFx18703000260xxx
-338	3.125	3.500	3.791	xxxxFFx18703125260xxx
-339	3.250	3.625	3.916	xxxxFFx18703250260xxx
-340	3.375	3.750	4.041	xxxxFFx18703375260xxx
-341	3.500	3.875	4.166	xxxxFFx18703500260xxx
-342	3.625	4.000	4.291	xxxxFFx18703625260xxx
-343	3.750	4.125	4.416	xxxxFFx18703750260xxx
-344	3.875	4.250	4.541	xxxxFFx18703875260xxx
-345	4.000	4.375	4.666	xxxxFFx18704000260xxx
-346	4.125	4.500	4.791	xxxxFFx18704125260xxx
-347	4.250	4.625	4.916	xxxxFFx18704250260xxx
-348	4.375	4.750	5.041	xxxxFFx18704375260xxx
-349	4.500	4.875	5.166	xxxxFFx18704500260xxx
-350	4.625	5.000	5.291	xxxxFFx18704625260xxx
-351	4.750	5.125	5.416	xxxxFFx18704750260xxx
-352	4.875	5.250	5.541	xxxxFFx18704875260xxx
-353	5.000	5.375	5.666	xxxxFFx18705000260xxx
-354	5.125	5.500	5.791	xxxxFFx18705125260xxx
-355	5.250	5.625	5.916	xxxxFFx18705250260xxx
-356	5.375	5.750	6.041	xxxxFFx18705375260xxx
-357	5.500	5.875	6.166	xxxxFFx18705500260xxx
-358	5.625	6.000	6.291	xxxxFFx18705625260xxx
-359	5.750	6.125	6.416	xxxxFFx18705750260xxx
-360	5.875	6.250	6.541	xxxxFFx18705875260xxx
-361	6.000	6.375	6.666	xxxxFFx18706000260xxx
-362	6.250	6.625	6.916	xxxxFFx18706250260xxx
-363	6.500	6.875	7.166	xxxxFFx18706500260xxx
-364	6.750	7.125	7.416	xxxxFFx18706750260xxx
-365	7.000	7.375	7.666	xxxxFFx18707000260xxx
-366	7.250	7.625	7.916	xxxxFFx18707250260xxx
-367	7.500	7.875	8.166	xxxxFFx18707500260xxx
-368	7.750	8.125	8.416	xxxxFFx18707750260xxx
-369	8.000	8.375	8.666	xxxxFFx18708000260xxx
-370	8.250	8.625	8.916	xxxxFFx18708250260xxx
-371	8.500	8.875	9.166	xxxxFFx18708500260xxx
-372	8.750	9.125	9.416	xxxxFFx18708750260xxx
-373	9.000	9.375	9.666	xxxxFFx18709000260xxx
-374	9.250	9.625	9.916	xxxxFFx18709250260xxx
-375	9.500	9.875	10.166	xxxxFFx18709500260xxx
-376	9.750	10.125	10.416	xxxxFFx18709750260xxx
-377	10.000	10.375	10.666	xxxxFFx18710000260xxx
-378	10.500	10.875	11.166	xxxxFFx18710500260xxx
-379	11.000	11.375	11.666	xxxxFFx18711000260xxx
-380	11.500	11.875	12.166	xxxxFFx18711500260xxx
-381	12.000	12.375	12.666	xxxxFFx18712000260xxx

See Section 4 for seal type description.

03/03/06



FlexiSeal® Inch

B

Dash #	A Shaft Dia.	B Groove Dia.	C Flange C-Bore Dia. Min.	Part Number
--------	--------------	---------------	---------------------------	-------------

R = 0.015" max. radius
 E = 0.003" max. K = 0.057" Ref.
 G for Standard heel groove = 0.281/0.291" (260 callout)
 D Gland Counterbore depth for seal flange = 0.028/0.032"

	+0.00/-0.02	+0.02/-0.00		
-382	13.000	13.375	13.666	xxxxFFx18713000260xxx
-383	14.000	14.375	14.666	xxxxFFx18714000260xxx
-384	15.000	15.375	15.666	xxxxFFx18715000260xxx
-385	16.000	16.375	16.666	xxxxFFx18716000260xxx
-386	17.000	17.375	17.666	xxxxFFx18717000260xxx
-387	18.000	18.375	18.666	xxxxFFx18718000260xxx
-388	19.000	19.375	19.666	xxxxFFx18719000260xxx
-389	20.000	20.375	20.666	xxxxFFx18720000260xxx
-390	21.000	21.375	21.666	xxxxFFx18721000260xxx
-391	22.000	22.375	22.666	xxxxFFx18722000260xxx
-392	23.000	23.375	23.666	xxxxFFx18723000260xxx
-393	24.000	24.375	24.666	xxxxFFx18724000260xxx
-394	25.000	25.375	25.666	xxxxFFx18725000260xxx
-395	26.000	26.375	26.666	xxxxFFx18726000260xxx

R = 0.015" max. radius
 E = 0.003" max. K = 0.069" Ref.
 G for Standard heel groove = 0.375/0.385" (355 callout)
 D Gland Counterbore depth for seal flange = 0.041/0.045"

	+0.00/-0.02	+0.02/-0.00		
-401	1.500	2.000	2.322	xxxxFFx25001500355xxx
-402	1.625	2.125	2.447	xxxxFFx25001625355xxx
-403	1.750	2.250	2.572	xxxxFFx25001750355xxx
-404	1.875	2.375	2.697	xxxxFFx25001875355xxx
-405	2.000	2.500	2.822	xxxxFFx25002000355xxx
-406	2.125	2.625	2.947	xxxxFFx25002125355xxx
-407	2.250	2.750	3.072	xxxxFFx25002250355xxx
-408	2.375	2.875	3.197	xxxxFFx25002375355xxx
-409	2.500	3.000	3.322	xxxxFFx25002500355xxx
-410	2.625	3.125	3.447	xxxxFFx25002625355xxx
-411	2.750	3.250	3.572	xxxxFFx25002750355xxx
-412	2.875	3.375	3.697	xxxxFFx25002875355xxx
-413	3.000	3.500	3.822	xxxxFFx25003000355xxx
-414	3.125	3.625	3.947	xxxxFFx25003125355xxx
-415	3.250	3.750	4.072	xxxxFFx25003250355xxx
-416	3.375	3.875	4.197	xxxxFFx25003375355xxx
-417	3.500	4.000	4.322	xxxxFFx25003500355xxx
-418	3.625	4.125	4.447	xxxxFFx25003625355xxx
-419	3.750	4.250	4.572	xxxxFFx25003750355xxx
-420	3.875	4.375	4.697	xxxxFFx25003875355xxx
-421	4.000	4.500	4.822	xxxxFFx25004000355xxx
-422	4.125	4.625	4.947	xxxxFFx25004125355xxx
-423	4.250	4.750	5.072	xxxxFFx25004250355xxx
-424	4.375	4.875	5.197	xxxxFFx25004375355xxx
-425	4.500	5.000	5.322	xxxxFFx25004500355xxx
-426	4.625	5.125	5.447	xxxxFFx25004625355xxx

Dash #	A Shaft Dia.	B Groove Dia.	C Flange C-Bore Dia. Min.	Part Number
-427	4.750	5.250	5.572	xxxxFFx25004750355xxx
-428	4.875	5.375	5.697	xxxxFFx25004875355xxx
-429	5.000	5.500	5.822	xxxxFFx25005000355xxx
-430	5.125	5.625	5.947	xxxxFFx25005125355xxx
-431	5.250	5.750	6.072	xxxxFFx25005250355xxx
-432	5.375	5.875	6.197	xxxxFFx25005375355xxx
-433	5.500	6.000	6.322	xxxxFFx25005500355xxx
-434	5.625	6.125	6.447	xxxxFFx25005625355xxx
-435	5.750	6.250	6.572	xxxxFFx25005750355xxx
-436	5.875	6.375	6.697	xxxxFFx25005875355xxx
-437	6.000	6.500	6.822	xxxxFFx25006000355xxx
-438	6.250	6.750	7.072	xxxxFFx25006250355xxx
-439	6.500	7.000	7.322	xxxxFFx25006500355xxx
-440	6.750	7.250	7.572	xxxxFFx25006750355xxx
-441	7.000	7.500	7.822	xxxxFFx25007000355xxx
-442	7.250	7.750	8.072	xxxxFFx25007250355xxx
-443	7.500	8.000	8.322	xxxxFFx25007500355xxx
-444	7.750	8.250	8.572	xxxxFFx25007750355xxx
-445	8.000	8.500	8.822	xxxxFFx25008000355xxx
-446	8.500	9.000	9.322	xxxxFFx25008500355xxx
-447	9.000	9.500	9.822	xxxxFFx25009000355xxx
-448	9.500	10.000	10.322	xxxxFFx25009500355xxx
-449	10.000	10.500	10.822	xxxxFFx25010000355xxx
-450	10.500	11.000	11.322	xxxxFFx25010500355xxx
-451	11.000	11.500	11.822	xxxxFFx25011000355xxx
-452	11.500	12.000	12.322	xxxxFFx25011500355xxx
-453	12.000	12.500	12.822	xxxxFFx25012000355xxx
-454	12.500	13.000	13.322	xxxxFFx25012500355xxx
-455	13.000	13.500	13.822	xxxxFFx25013000355xxx
-456	13.500	14.000	14.322	xxxxFFx25013500355xxx
-457	14.000	14.500	14.822	xxxxFFx25014000355xxx
-458	14.500	15.000	15.322	xxxxFFx25014500355xxx
-459	15.000	15.500	15.822	xxxxFFx25015000355xxx
-460	15.500	16.000	16.322	xxxxFFx25015500355xxx
-461	16.000	16.500	16.822	xxxxFFx25016000355xxx
-462	16.500	17.000	17.322	xxxxFFx25016500355xxx
-463	17.000	17.500	17.822	xxxxFFx25017000355xxx
-464	17.500	18.000	18.322	xxxxFFx25017500355xxx
-465	18.000	18.500	18.822	xxxxFFx25018000355xxx
-466	18.500	19.000	19.322	xxxxFFx25018500355xxx
-467	19.000	19.500	19.822	xxxxFFx25019000355xxx
-468	19.500	20.000	20.322	xxxxFFx25019500355xxx
-469	20.000	20.500	20.822	xxxxFFx25020000355xxx
-470	21.000	21.500	21.822	xxxxFFx25021000355xxx
-471	22.000	22.500	22.822	xxxxFFx25022000355xxx
-472	23.000	23.500	23.822	xxxxFFx25023000355xxx
-473	24.000	24.500	24.822	xxxxFFx25024000355xxx
-474	25.000	25.500	25.822	xxxxFFx25025000355xxx
-475	26.000	26.500	26.822	xxxxFFx25026000355xxx

See Section 4 for seal type description.

03/03/06



Rotary Lip Seal Metric Sizes

Catalog EPS 5350/USA

5 to 12

Shaft Dia.	Bore Dia.	Seal Width	Parker Part Number	Seal Type	Material
5	15	6	5-15-6MSCN	SC	NBR
5	15	6	5-15-6MSCV	SC	FKM
5	15	6	5-15-6MTCN	TC	NBR
5	15	6	5-15-6MVCN	VC	NBR
5	16	7	5-16-7MSCN	SC	NBR
5	16	7	5-16-7MSCV	SC	FKM
5	16	7	5-16-7MTCN	TC	NBR
5	16	7	5-16-7MVCN	VC	NBR
5	17	7	5-17-7MSCN	SC	NBR
5	17	7	5-17-7MSCV	SC	FKM
5	17	7	5-17-7MTCN	TC	NBR
5	17	7	5-17-7MVCN	VC	NBR
6	16	5	6-16-5MSCN	SC	NBR
6	16	5	6-16-5MSCV	SC	FKM
6	16	5	6-16-5MTCN	TC	NBR
6	16	5	6-16-5MVCN	VC	NBR
6	18	7	6-18-7MSCN	SC	NBR
6	18	7	6-18-7MSCV	SC	FKM
6	18	7	6-18-7MTCN	TC	NBR
6	18	7	6-18-7MVCN	VC	NBR
7	16	7	7-16-7MSCN	SC	NBR
7	16	7	7-16-7MSCV	SC	FKM
7	16	7	7-16-7MTCN	TC	NBR
7	16	7	7-16-7MVCN	VC	NBR
7	19	7	7-19-7MSCN	SC	NBR
7	19	7	7-19-7MSCV	SC	FKM
7	19	7	7-19-7MTCN	TC	NBR
7	19	7	7-19-7MVCN	VC	NBR
7	22	6	7-22-6MSCN	SC	NBR
7	22	6	7-22-6MSCV	SC	FKM
7	22	6	7-22-6MTCN	TC	NBR
7	22	6	7-22-6MVCN	VC	NBR
8	15	5	8-15-5MSCN	SC	NBR
8	15	5	8-15-5MSCV	SC	FKM
8	15	5	8-15-5MTCN	TC	NBR
8	15	5	8-15-5MVCN	VC	NBR
8	16	7	8-16-7MSCN	SC	NBR
8	16	7	8-16-7MSCV	SC	FKM
8	16	7	8-16-7MTCN	TC	NBR
8	16	7	8-16-7MVCN	VC	NBR
8	18	5	8-18-5MSCN	SC	NBR
8	18	5	8-18-5MSCV	SC	FKM
8	18	5	8-18-5MTCN	TC	NBR
8	18	5	8-18-5MVCN	VC	NBR
8	19	6	M 7016 H3L8	SS	CR
8	20	5	8-20-5MSCN	SC	NBR
8	20	5	8-20-5MSCV	SC	FKM
8	20	5	8-20-5MTCN	TC	NBR
8	20	5	8-20-5MVCN	VC	NBR
8	22	7	8-22-7MSCN	SC	NBR
8	22	7	8-22-7MSCV	SC	FKM
8	22	7	8-22-7MTCN	TC	NBR
8	22	7	8-22-7MVCN	VC	NBR
8	30	6	8-30-6MSCN	SC	NBR
8	30	6	8-30-6MSCV	SC	FKM
8	30	6	8-30-6MTCN	TC	NBR
8	30	6	8-30-6MVCN	VC	NBR
9	19	5	9-19-5MSCN	SC	NBR
9	19	5	9-19-5MSCV	SC	FKM
9	19	5	9-19-5MTCN	TC	NBR

Shaft Dia.	Bore Dia.	Seal Width	Parker Part Number	Seal Type	Material
9	19	5	9-19-5MVCN	VC	NBR
9	20	7	9-20-7MSCN	SC	NBR
9	20	7	9-20-7MSCV	SC	FKM
9	20	7	9-20-7MTCN	TC	NBR
9	20	7	9-20-7MVCN	VC	NBR
9	22	7	9-22-7MSCN	SC	NBR
9	22	7	9-22-7MSCV	SC	FKM
9	22	7	9-22-7MTCN	TC	NBR
9	22	7	9-22-7MVCN	VC	NBR
9	24	7	9-24-7MSCN	SC	NBR
9	24	7	9-24-7MSCV	SC	FKM
9	24	7	9-24-7MTCN	TC	NBR
9	24	7	9-24-7MVCN	VC	NBR
10	17	5	10-17-5MSCN	SC	NBR
10	17	5	10-17-5MSCV	SC	FKM
10	17	5	10-17-5MTCN	TC	NBR
10	17	5	10-17-5MVCN	VC	NBR
10	18	7	10-18-7MSCN	SC	NBR
10	18	7	10-18-7MSCV	SC	FKM
10	18	7	10-18-7MTCN	TC	NBR
10	18	7	10-18-7MVCN	VC	NBR
10	19	5	M 6362 H1L7	SS	NBR
10	19	7	10-19-7MSCN	SC	NBR
10	19	7	10-19-7MSCV	SC	FKM
10	19	7	10-19-7MTCN	TC	NBR
10	19	7	10-19-7MVCN	VC	NBR
10	22	7	M 16513 H1L7	P	NBR
10	22	7	10-22-7MSCN	SC	NBR
10	22	7	10-22-7MSCV	SC	FKM
10	22	7	10-22-7MTCN	TC	NBR
10	22	7	10-22-7MVCN	VC	NBR
10	23	7	10-23-7MSCN	SC	NBR
10	23	7	10-23-7MSCV	SC	FKM
10	23	7	10-23-7MTCN	TC	NBR
10	23	7	10-23-7MVCN	VC	NBR
10	24	6	10-24-6MSCN	SC	NBR
10	24	6	10-24-6MSCV	SC	FKM
10	24	6	10-24-6MTCN	TC	NBR
10	24	6	10-24-6MVCN	VC	NBR
10	25	5	10-25-5MSCN	SC	NBR
10	25	5	10-25-5MSCV	SC	FKM
10	25	5	10-25-5MTCN	TC	NBR
10	25	5	10-25-5MVCN	VC	NBR
10	26	7	10-26-7MSCN	SC	NBR
10	26	7	10-26-7MSCV	SC	FKM
10	26	7	10-26-7MTCN	TC	NBR
10	26	7	10-26-7MVCN	VC	NBR
10	30	8	M 12276 H1L5	LPD	NBR
11	19	6	M 9117 H3L8	SS	CR
12	19	5	12-19-5MSCN	SC	NBR
12	19	5	12-19-5MSCV	SC	FKM
12	19	5	12-19-5MTCN	TC	NBR
12	19	5	12-19-5MVCN	VC	NBR
12	20	4	12-20-4MSCN	SC	NBR
12	20	4	12-20-4MSCV	SC	FKM
12	20	4	12-20-4MTCN	TC	NBR
12	20	4	12-20-4MVCN	VC	NBR
12	21	4	12-21-4MSCN	SC	NBR
12	21	4	12-21-4MSCV	SC	FKM
12	21	4	12-21-4MTCN	TC	NBR



See Section 4 for seal type description. For FlexiSeal Listings see Page C-22.

03/03/06



Rotary Lip Seal Metric Sizes

C

Shaft Dia.	Bore Dia.	Seal Width	Parker Part Number	Seal Type	Material
12	21	4	12-21-4MVCN	VC	NBR
12	22	7	12-22-7MSCN	SC	NBR
12	22	7	12-22-7MSCV	SC	FKM
12	22	7	12-22-7MTCN	TC	NBR
12	22	7	12-22-7MVCN	VC	NBR
12	24	7	M 14725 H1L7	P	NBR
12	24	7	12-24-7MSCN	SC	NBR
12	24	7	12-24-7MSCV	SC	FKM
12	24	7	12-24-7MTCN	TC	NBR
12	24	7	12-24-7MVCN	VC	NBR
12	25	7	12-25-7MSCN	SC	NBR
12	25	7	12-25-7MSCV	SC	FKM
12	25	7	12-25-7MTCN	TC	NBR
12	25	7	12-25-7MVCN	VC	NBR
12	26	7	12-26-7MSCN	SC	NBR
12	26	7	12-26-7MSCV	SC	FKM
12	26	7	12-26-7MTCN	TC	NBR
12	26	7	12-26-7MVCN	VC	NBR
12	28	7	12-28-7MSCN	SC	NBR
12	28	7	12-28-7MSCV	SC	FKM
12	28	7	12-28-7MTCN	TC	NBR
12	28	7	12-28-7MVCN	VC	NBR
12	30	7	12-30-7MSCN	SC	NBR
12	30	7	12-30-7MSCV	SC	FKM
12	30	7	12-30-7MTCN	TC	NBR
12	30	7	12-30-7MVCN	VC	NBR
13	19	4	M 11124 H1L5	SS	NBR
13	22	4	13-22-4MSCN	SC	NBR
13	22	4	13-22-4MSCV	SC	FKM
13	22	4	13-22-4MTCN	TC	NBR
13	22	4	13-22-4MVCN	VC	NBR
13	23	5	M 5899 H1L7	SS	NBR
13	26	7	13-26-7MSCN	SC	NBR
13	26	7	13-26-7MSCV	SC	FKM
13	26	7	13-26-7MTCN	TC	NBR
13	26	7	13-26-7MVCN	VC	NBR
13	27	5	M 5845 H1L7	SS	NBR
13	35	10	M 8855 H1L7	SS	NBR
14	20	4	14-20-4MSCN	SC	NBR
14	20	4	14-20-4MSCV	SC	FKM
14	20	4	14-20-4MTCN	TC	NBR
14	20	4	14-20-4MVCN	VC	NBR
14	22	5	14-22-5MSCN	SC	NBR
14	22	5	14-22-5MSCV	SC	FKM
14	22	5	14-22-5MTCN	TC	NBR
14	22	5	14-22-5MVCN	VC	NBR
14	24	7	14-24-7MSCN	SC	NBR
14	24	7	14-24-7MSCV	SC	FKM
14	24	7	14-24-7MTCN	TC	NBR
14	24	7	14-24-7MVCN	VC	NBR
14	25	5	14-25-5MSCN	SC	NBR
14	25	5	14-25-5MSCV	SC	FKM
14	25	5	14-25-5MTCN	TC	NBR
14	25	5	14-25-5MVCN	VC	NBR
14	25	7	14-25-7MSCN	SC	NBR
14	25	7	14-25-7MSCV	SC	FKM
14	25	7	14-25-7MTCN	TC	NBR
14	25	7	14-25-7MVCN	VC	NBR
14	26	7	14-26-7MSCN	SC	NBR
14	26	7	14-26-7MSCV	SC	FKM
14	26	7	14-26-7MTCN	TC	NBR
14	26	7	14-26-7MVCN	VC	NBR
14	28	7	14-28-7MSCN	SC	NBR
14	28	7	14-28-7MSCV	SC	FKM
14	28	7	14-28-7MTCN	TC	NBR
14	28	7	14-28-7MVCN	VC	NBR

Shaft Dia.	Bore Dia.	Seal Width	Parker Part Number	Seal Type	Material
14	30	7	14-30-7MSCN	SC	NBR
14	30	7	14-30-7MSCV	SC	FKM
14	30	7	14-30-7MTCN	TC	NBR
14	30	7	14-30-7MVCN	VC	NBR
14	32	7	14-32-7MSCN	SC	NBR
14	32	7	14-32-7MSCV	SC	FKM
14	32	7	14-32-7MTCN	TC	NBR
14	32	7	14-32-7MVCN	VC	NBR
14	35	7	14-35-7MSCN	SC	NBR
14	35	7	14-35-7MSCV	SC	FKM
14	35	7	14-35-7MTCN	TC	NBR
14	35	7	14-35-7MVCN	VC	NBR
15	22	5	15-22-5MSCN	SC	NBR
15	22	5	15-22-5MSCV	SC	FKM
15	22	5	15-22-5MTCN	TC	NBR
15	22	5	15-22-5MVCN	VC	NBR
15	23	7	15-23-7MSCN	SC	NBR
15	23	7	15-23-7MSCV	SC	FKM
15	23	7	15-23-7MTCN	TC	NBR
15	23	7	15-23-7MVCN	VC	NBR
15	24	5	15-24-5MSCN	SC	NBR
15	24	5	15-24-5MSCV	SC	FKM
15	24	5	15-24-5MTCN	TC	NBR
15	24	5	15-24-5MVCN	VC	NBR
15	25	5	15-25-5MSCN	SC	NBR
15	25	5	15-25-5MSCV	SC	FKM
15	25	5	15-25-5MTCN	TC	NBR
15	25	5	15-25-5MVCN	VC	NBR
15	25	7	15-25-7MSCN	SC	NBR
15	25	7	15-25-7MSCV	SC	FKM
15	25	7	15-25-7MTCN	TC	NBR
15	25	7	15-25-7MVCN	VC	NBR
15	26	7	15-26-7MSCN	SC	NBR
15	26	7	15-26-7MSCV	SC	FKM
15	26	7	15-26-7MTCN	TC	NBR
15	26	7	15-26-7MVCN	VC	NBR
15	27	7	15-27-7MSCN	SC	NBR
15	27	7	15-27-7MSCV	SC	FKM
15	27	7	15-27-7MTCN	TC	NBR
15	27	7	15-27-7MVCN	VC	NBR
15	27	9	M 15476 H1L7	P	NBR
15	28	7	15-28-7MSCN	SC	NBR
15	28	7	15-28-7MSCV	SC	FKM
15	28	7	15-28-7MTCN	TC	NBR
15	28	7	15-28-7MVCN	VC	NBR
15	30	7	15-30-7MSCN	SC	NBR
15	30	7	15-30-7MSCV	SC	FKM
15	30	7	15-30-7MTCN	TC	NBR
15	30	7	15-30-7MVCN	VC	NBR
15	32	7	15-32-7MSCN	SC	NBR
15	32	7	15-32-7MSCV	SC	FKM
15	32	7	15-32-7MTCN	TC	NBR
15	32	7	15-32-7MVCN	VC	NBR
15	35	7	15-35-7MSCN	SC	NBR
15	35	7	15-35-7MSCV	SC	FKM
15	35	7	15-35-7MTCN	TC	NBR
15	35	7	15-35-7MVCN	VC	NBR
15	35	8	M 14981 H1L5	LPD	NBR
15	40	10	15-40-10MSCN	SC	NBR
15	40	10	15-40-10MSCV	SC	FKM
15	40	10	15-40-10MTCN	TC	NBR
15	40	10	15-40-10MVCN	VC	NBR
15	42	10	15-42-10MSCN	SC	NBR
15	42	10	15-42-10MSCV	SC	FKM
15	42	10	15-42-10MTCN	TC	NBR
15	42	10	15-42-10MVCN	VC	NBR

See Section 4 for seal type description. For FlexiSeal Listings see Page C-22.

03/03/06



Rotary Lip Seal Metric Sizes

Shaft Dia.	Bore Dia.	Seal Width	Parker Part Number	Seal Type	Material
16	24	5	16-24-5MSCN	SC	NBR
16	24	5	16-24-5MSCV	SC	FKM
16	24	5	16-24-5MTCN	TC	NBR
16	24	5	16-24-5MVCN	VC	NBR
16	25	6	16-25-6MSCN	SC	NBR
16	25	6	16-25-6MSCV	SC	FKM
16	25	6	16-25-6MTCN	TC	NBR
16	25	6	16-25-6MVCN	VC	NBR
16	26	6	16-26-6MSCN	SC	NBR
16	26	6	16-26-6MSCV	SC	FKM
16	26	6	16-26-6MTCN	TC	NBR
16	26	6	16-26-6MVCN	VC	NBR
16	27	6	16-27-6MSCN	SC	NBR
16	27	6	16-27-6MSCV	SC	FKM
16	27	6	M 5139 H1L7	SS	NBR
16	27	6	16-27-6MTCN	TC	NBR
16	27	6	16-27-6MVCN	VC	NBR
16	28	7	M 14724 H1L7	P	NBR
16	28	7	16-28-7MSCN	SC	NBR
16	28	7	16-28-7MSCV	SC	FKM
16	28	7	16-28-7MTCN	TC	NBR
16	28	7	16-28-7MVCN	VC	NBR
16	29	7	16-29-7MSCN	SC	NBR
16	29	7	16-29-7MSCV	SC	FKM
16	29	7	16-29-7MTCN	TC	NBR
16	29	7	16-29-7MVCN	VC	NBR
16	30	7	16-30-7MSCN	SC	NBR
16	30	7	16-30-7MSCV	SC	FKM
16	30	7	16-30-7MTCN	TC	NBR
16	30	7	16-30-7MVCN	VC	NBR
16	30	10	M 9756 H1L5	LUP	NBR
16	32	7	16-32-7MSCN	SC	NBR
16	32	7	16-32-7MSCV	SC	FKM
16	32	7	16-32-7MTCN	TC	NBR
16	32	7	16-32-7MVCN	VC	NBR
16	35	7	16-35-7MSCN	SC	NBR
16	35	7	16-35-7MSCV	SC	FKM
16	35	7	16-35-7MTCN	TC	NBR
16	35	7	16-35-7MVCN	VC	NBR
16	35	8	M 5506 H1L7	SS	NBR
16	35	9	M 12876 H1L5	LUP	NBR
16	35	11	M 4880 H1L5	LUP	NBR
16	38	11	M 9152 H1L5	LUP	NBR
16	40	1	16-40-1MSCN	SC	NBR
16	40	1	16-40-1MSCV	SC	FKM
16	40	1	16-40-1MTCN	TC	NBR
16	40	1	16-40-1MVCN	VC	NBR
17	25	4	17-25-4MSCN	SC	NBR
17	25	4	17-25-4MSCV	SC	FKM
17	25	4	17-25-4MTCN	TC	NBR
17	25	4	17-25-4MVCN	VC	NBR
17	27	3	M 17777 H3L8	SS	CR
17	27	7	17-27-7MSCN	SC	NBR
17	27	7	17-27-7MSCV	SC	FKM
17	27	7	17-27-7MTCN	TC	NBR
17	27	7	17-27-7MVCN	VC	NBR
17	28	6	17-28-6MSCN	SC	NBR
17	28	6	17-28-6MSCV	SC	FKM
17	28	6	17-28-6MTCN	TC	NBR
17	28	6	17-28-6MVCN	VC	NBR
17	29	5	17-29-5MSCN	SC	NBR
17	29	5	17-29-5MSCV	SC	FKM
17	29	5	17-29-5MTCN	TC	NBR
17	29	5	17-29-5MVCN	VC	NBR
17	30	7	17-30-7MSCN	SC	NBR
17	30	7	17-30-7MSCV	SC	FKM

Shaft Dia.	Bore Dia.	Seal Width	Parker Part Number	Seal Type	Material
17	30	7	17-30-7MTCN	TC	NBR
17	30	7	17-30-7MVCN	VC	NBR
17	32	7	17-32-7MSCN	SC	NBR
17	32	7	17-32-7MSCV	SC	FKM
17	32	7	17-32-7MTCN	TC	NBR
17	32	7	17-32-7MVCN	VC	NBR
17	33	7	17-33-7MSCN	SC	NBR
17	33	7	17-33-7MSCV	SC	FKM
17	33	7	17-33-7MTCN	TC	NBR
17	33	7	17-33-7MVCN	VC	NBR
17	34	4	17-34-4MSCN	SC	NBR
17	34	4	17-34-4MSCV	SC	FKM
17	34	4	17-34-4MTCN	TC	NBR
17	34	4	17-34-4MVCN	VC	NBR
17	35	7	17-35-7MSCN	SC	NBR
17	35	7	17-35-7MSCV	SC	FKM
17	35	7	17-35-7MTCN	TC	NBR
17	35	7	17-35-7MVCN	VC	NBR
17	35	8	M 5831 H1L5	LUP	NBR
17	37	7	17-37-7MSCN	SC	NBR
17	37	7	17-37-7MSCV	SC	FKM
17	37	7	17-37-7MTCN	TC	NBR
17	37	7	17-37-7MVCN	VC	NBR
17	40	5	17-40-5MSCN	SC	NBR
17	40	5	17-40-5MSCV	SC	FKM
17	40	5	17-40-5MTCN	TC	NBR
17	40	5	17-40-5MVCN	VC	NBR
17	40	6	M 10336 H1L5	LUP	NBR
17	40	8	M 9305 H1L5	LUP	NBR
17	47	7	17-47-7MSCN	SC	NBR
17	47	7	17-47-7MSCV	SC	FKM
17	47	7	17-47-7MTCN	TC	NBR
17	47	7	17-47-7MVCN	VC	NBR
18	28	6	18-28-6MSCN	SC	NBR
18	28	6	18-28-6MSCV	SC	FKM
18	28	6	18-28-6MTCN	TC	NBR
18	28	6	18-28-6MVCN	VC	NBR
18	30	5	18-30-5MSCN	SC	NBR
18	30	5	18-30-5MSCV	SC	FKM
18	30	5	18-30-5MTCN	TC	NBR
18	30	5	18-30-5MVCN	VC	NBR
18	32	7	18-32-7MSCN	SC	NBR
18	32	7	18-32-7MSCV	SC	FKM
18	32	7	18-32-7MTCN	TC	NBR
18	32	7	18-32-7MVCN	VC	NBR
18	35	7	18-35-7MSCN	SC	NBR
18	35	7	18-35-7MSCV	SC	FKM
18	35	7	18-35-7MTCN	TC	NBR
18	35	7	18-35-7MVCN	VC	NBR
18	35	8	M 10904 H1L5	LUP	NBR
18	38	7	18-38-7MSCN	SC	NBR
18	38	7	18-38-7MSCV	SC	FKM
18	38	7	18-38-7MTCN	TC	NBR
18	38	7	18-38-7MVCN	VC	NBR
18	40	7	18-40-7MSCN	SC	NBR
18	40	7	18-40-7MSCV	SC	FKM
18	40	7	18-40-7MTCN	TC	NBR
18	40	7	18-40-7MVCN	VC	NBR
18	47	10	18-47-10MSCN	SC	NBR
18	47	10	18-47-10MSCV	SC	FKM
18	47	10	18-47-10MTCN	TC	NBR
18	47	10	18-47-10MVCN	VC	NBR
19	24	7	19-24-7MSCN	SC	NBR
19	24	7	19-24-7MSCV	SC	FKM
19	24	7	19-24-7MTCN	TC	NBR
19	24	7	19-24-7MVCN	VC	NBR



See Section 4 for seal type description. For FlexiSeal Listings see Page C-22.

03/03/06



Rotary Lip Seal Metric Sizes

C

Shaft Dia.	Bore Dia.	Seal Width	Parker Part Number	Seal Type	Material
19	27	4	19-27-4MSCN	SC	NBR
19	27	4	19-27-4MSCV	SC	FKM
19	27	4	19-27-4MTCN	TC	NBR
19	27	4	19-27-4MVCN	VC	NBR
19	30	5	19-30-5MSCN	SC	NBR
19	30	5	19-30-5MSCV	SC	FKM
19	30	5	19-30-5MTCN	TC	NBR
19	30	5	19-30-5MVCN	VC	NBR
19	32	7	19-32-7MSCN	SC	NBR
19	32	7	19-32-7MSCV	SC	FKM
19	32	7	19-32-7MTCN	TC	NBR
19	32	7	19-32-7MVCN	VC	NBR
19	35	7	19-35-7MSCN	SC	NBR
19	35	7	19-35-7MSCV	SC	FKM
19	35	7	19-35-7MTCN	TC	NBR
19	35	7	19-35-7MVCN	VC	NBR
19	35	8	M 9377 H1L5	LUP	NBR
19	35	8	M 9956 H1L5	RUP	NBR
19	35	10	M 8463 H1L5	LPD	NBR
19	37	10	19-37-10MSCN	SC	NBR
19	37	10	19-37-10MSCV	SC	FKM
19	37	10	19-37-10MTCN	TC	NBR
19	37	10	19-37-10MVCN	VC	NBR
19	38	8	M 13068 H1L5	LUP	NBR
19	38	9	M 6932 H1L5	LA	NBR
19	38	9	M 12564 H1L5	LDS	NBR
19	38	9	M 6418 H1L7	SS	NBR
19	40	11	M 6440 H1L7	SS	NBR
19	47	7	19-47-7MSCN	SC	NBR
19	47	7	19-47-7MSCV	SC	FKM
19	47	7	19-47-7MTCN	TC	NBR
19	47	7	19-47-7MVCN	VC	NBR
20	28	6	20-28-6MSCN	SC	NBR
20	28	6	20-28-6MSCV	SC	FKM
20	28	6	20-28-6MTCN	TC	NBR
20	28	6	20-28-6MVCN	VC	NBR
20	30	5	20-30-5MSCN	SC	NBR
20	30	5	20-30-5MSCV	SC	FKM
20	30	5	20-30-5MTCN	TC	NBR
20	30	5	20-30-5MVCN	VC	NBR
20	32	6	20-32-6MSCN	SC	NBR
20	32	6	20-32-6MSCV	SC	FKM
20	32	6	20-32-6MTCN	TC	NBR
20	32	6	20-32-6MVCN	VC	NBR
20	32	9	M 14779 H1L5	LPD	NBR
20	35	7	20-35-7MSCN	SC	NBR
20	35	7	20-35-7MSCV	SC	FKM
20	35	7	20-35-7MTCN	TC	NBR
20	35	7	20-35-7MVCN	VC	NBR
20	35	8	M 11924 H1L5	LPD	NBR
20	35	10	M 18798 H1L5	LUP	NBR
20	36	7	20-36-7MSCN	SC	NBR
20	36	7	20-36-7MSCV	SC	FKM
20	36	7	20-36-7MTCN	TC	NBR
20	36	7	20-36-7MVCN	VC	NBR
20	37	7	20-37-7MSCN	SC	NBR
20	37	7	20-37-7MSCV	SC	FKM
20	37	7	20-37-7MTCN	TC	NBR
20	37	7	20-37-7MVCN	VC	NBR
20	38	5	20-38-5MSCN	SC	NBR
20	38	5	20-38-5MSCV	SC	FKM
20	38	5	20-38-5MTCN	TC	NBR
20	38	5	20-38-5MVCN	VC	NBR
20	40	7	20-40-7MSCN	SC	NBR
20	40	7	20-40-7MSCV	SC	FKM
20	40	7	20-40-7MTCN	TC	NBR

Shaft Dia.	Bore Dia.	Seal Width	Parker Part Number	Seal Type	Material
20	40	7	20-40-7MVCN	VC	NBR
20	42	7	20-42-7MSCN	SC	NBR
20	42	7	20-42-7MSCV	SC	FKM
20	42	7	20-42-7MTCN	TC	NBR
20	42	7	20-42-7MVCN	VC	NBR
20	45	7	20-45-7MSCN	SC	NBR
20	45	7	20-45-7MSCV	SC	FKM
20	45	7	20-45-7MTCN	TC	NBR
20	45	7	20-45-7MVCN	VC	NBR
20	47	7	20-47-7MSCN	SC	NBR
20	47	7	20-47-7MSCV	SC	FKM
20	47	7	20-47-7MTCN	TC	NBR
20	47	7	20-47-7MVCN	VC	NBR
20	47	13	M 11903 H1L5	LUP	NBR
20	52	7	20-52-7MSCN	SC	NBR
20	52	7	20-52-7MSCV	SC	FKM
20	52	7	20-52-7MTCN	TC	NBR
20	52	7	20-52-7MVCN	VC	NBR
21	35	8	M 9743 H1L5	LPD	NBR
21	38	10	M 7348 H1L5	LPD	NBR
22	30	7	22-30-7MSCN	SC	NBR
22	30	7	22-30-7MSCV	SC	FKM
22	30	7	22-30-7MTCN	TC	NBR
22	30	7	22-30-7MVCN	VC	NBR
22	32	7	22-32-7MSCN	SC	NBR
22	32	7	22-32-7MSCV	SC	FKM
22	32	7	22-32-7MTCN	TC	NBR
22	32	7	22-32-7MVCN	VC	NBR
22	35	6	M 5660 H1L5	LUP	NBR
22	35	7	22-35-7MSCN	SC	NBR
22	35	7	22-35-7MSCV	SC	FKM
22	35	7	22-35-7MTCN	TC	NBR
22	35	7	22-35-7MVCN	VC	NBR
22	35	8	M 4187 H1L5	RUP	NBR
22	36	7	22-36-7MSCN	SC	NBR
22	36	7	22-36-7MSCV	SC	FKM
22	36	7	22-36-7MTCN	TC	NBR
22	36	7	22-36-7MVCN	VC	NBR
22	38	7	22-38-7MSCN	SC	NBR
22	38	7	22-38-7MSCV	SC	FKM
22	38	7	22-38-7MTCN	TC	NBR
22	38	7	22-38-7MVCN	VC	NBR
22	38	9	M 16463 H1L5	LDS	NBR
22	38	9	M 8464 H1L5	LUP	NBR
22	38	9	M 5780 H1L7	SS	NBR
22	40	7	22-40-7MSCN	SC	NBR
22	40	7	22-40-7MSCV	SC	FKM
22	40	7	22-40-7MTCN	TC	NBR
22	40	7	22-40-7MVCN	VC	NBR
22	40	8	M 6628 H1L7	SS	NBR
22	42	7	22-42-7MSCN	SC	NBR
22	42	7	22-42-7MSCV	SC	FKM
22	42	7	22-42-7MTCN	TC	NBR
22	42	7	22-42-7MVCN	VC	NBR
22	47	7	22-47-7MSCN	SC	NBR
22	47	7	22-47-7MSCV	SC	FKM
22	47	7	22-47-7MTCN	TC	NBR
22	47	7	22-47-7MVCN	VC	NBR
23	34	8	23-34-8MSCN	SC	NBR
23	34	8	23-34-8MSCV	SC	FKM
23	34	8	23-34-8MTCN	TC	NBR
23	34	8	23-34-8MVCN	VC	NBR
23	35	8	M 9415 H1L5	LPD	NBR
23	35	8	M 6133 H1L7	SS	NBR
23	35	9	M 6988 H1L5	LPD	NBR
23	35	10	M 9421 H1L5	LPD	NBR

See Section 4 for seal type description. For FlexiSeal Listings see Page C-22.

03/03/06



Rotary Lip Seal Metric Sizes

Shaft Dia.	Bore Dia.	Seal Width	Parker Part Number	Seal Type	Material
23	36	7	23-36-7MSCN	SC	NBR
23	36	7	23-36-7MSCV	SC	FKM
23	36	7	23-36-7MTCN	TC	NBR
23	36	7	23-36-7MVCN	VC	NBR
23	40	7	23-40-7MSCN	SC	NBR
23	40	7	23-40-7MSCV	SC	FKM
23	40	7	23-40-7MTCN	TC	NBR
23	40	7	23-40-7MVCN	VC	NBR
23	47	7	23-47-7MSCN	SC	NBR
23	47	7	23-47-7MSCV	SC	FKM
23	47	7	23-47-7MTCN	TC	NBR
23	47	7	23-47-7MVCN	VC	NBR
24	34	7	24-34-7MSCN	SC	NBR
24	34	7	24-34-7MSCV	SC	FKM
24	34	7	24-34-7MTCN	TC	NBR
24	34	7	24-34-7MVCN	VC	NBR
24	35	6	24-35-6MSCN	SC	NBR
24	35	6	24-35-6MSCV	SC	FKM
24	35	6	24-35-6MTCN	TC	NBR
24	35	6	24-35-6MVCN	VC	NBR
24	36	7	24-36-7MSCN	SC	NBR
24	36	7	24-36-7MSCV	SC	FKM
24	36	7	24-36-7MTCN	TC	NBR
24	36	7	24-36-7MVCN	VC	NBR
24	37	7	24-37-7MSCN	SC	NBR
24	37	7	24-37-7MSCV	SC	FKM
24	37	7	24-37-7MTCN	TC	NBR
24	37	7	24-37-7MVCN	VC	NBR
24	38	8	24-38-8MSCN	SC	NBR
24	38	8	24-38-8MSCV	SC	FKM
24	38	8	24-38-8MTCN	TC	NBR
24	38	8	24-38-8MVCN	VC	NBR
24	38	9	M 10229 H1L5	LUP	NBR
24	40	7	24-40-7MSCN	SC	NBR
24	40	7	24-40-7MSCV	SC	FKM
24	40	7	24-40-7MTCN	TC	NBR
24	40	7	24-40-7MVCN	VC	NBR
24	42	8	24-42-8MSCN	SC	NBR
24	42	8	24-42-8MSCV	SC	FKM
24	42	8	24-42-8MTCN	TC	NBR
24	42	8	24-42-8MVCN	VC	NBR
24	45	7	24-45-7MSCN	SC	NBR
24	45	7	24-45-7MSCV	SC	FKM
24	45	7	24-45-7MTCN	TC	NBR
24	45	7	24-45-7MVCN	VC	NBR
24	52	7	24-52-7MSCN	SC	NBR
24	52	7	24-52-7MSCV	SC	FKM
24	52	7	24-52-7MTCN	TC	NBR
24	52	7	24-52-7MVCN	VC	NBR
25	35	5	25-35-5MSCN	SC	NBR
25	35	5	25-35-5MSCV	SC	FKM
25	35	5	25-35-5MTCN	TC	NBR
25	35	5	25-35-5MVCN	VC	NBR
25	36	7	25-36-7MSCN	SC	NBR
25	36	7	25-36-7MSCV	SC	FKM
25	36	7	25-36-7MTCN	TC	NBR
25	36	7	25-36-7MVCN	VC	NBR
25	37	6	25-37-6MSCN	SC	NBR
25	37	6	25-37-6MSCV	SC	FKM
25	37	6	25-37-6MTCN	TC	NBR
25	37	6	25-37-6MVCN	VC	NBR
25	38	5	25-38-5MSCN	SC	NBR
25	38	5	25-38-5MSCV	SC	FKM
25	38	5	25-38-5MTCN	TC	NBR
25	38	5	25-38-5MVCN	VC	NBR
25	38	7	M 14001 H1L7	P	NBR

Shaft Dia.	Bore Dia.	Seal Width	Parker Part Number	Seal Type	Material
25	38	8	M 7116 H1L5	LUP	NBR
25	38	8	M 9744 H1L5	LUP	NBR
25	38	8	M 9859 H1L5	LUP	NBR
25	38	8	M 15490 H1L5	LUP	NBR
25	38	8	M 4149 H1L5	RPD	NBR
25	38	9	M 5853 H1L5	LA	NBR
25	38	9	M 14058 H1L5	LUP	NBR
25	38	9	M 11316 H1L7	SS	NBR
25	38	10	M 6084 H1L5	LUP	NBR
25	40	7	25-40-7MSCN	SC	NBR
25	40	7	25-40-7MSCV	SC	FKM
25	40	7	25-40-7MTCN	TC	NBR
25	40	7	25-40-7MVCN	VC	NBR
25	40	10	M 14251 H1L5	LPD	NBR
25	42	6	25-42-6MSCN	SC	NBR
25	42	6	25-42-6MSCV	SC	FKM
25	42	6	25-42-6MTCN	TC	NBR
25	42	6	25-42-6MVCN	VC	NBR
25	42	10	M 17238 H1L5	LUP	NBR
25	43	10	25-43-10MSCN	SC	NBR
25	43	10	25-43-10MSCV	SC	FKM
25	43	10	25-43-10MTCN	TC	NBR
25	43	10	25-43-10MVCN	VC	NBR
25	44	7	25-44-7MSCN	SC	NBR
25	44	7	25-44-7MSCV	SC	FKM
25	44	7	25-44-7MTCN	TC	NBR
25	44	7	25-44-7MVCN	VC	NBR
25	45	7	25-45-7MSCN	SC	NBR
25	45	7	25-45-7MSCV	SC	FKM
25	45	7	25-45-7MTCN	TC	NBR
25	45	7	25-45-7MVCN	VC	NBR
25	46	7	25-46-7MSCN	SC	NBR
25	46	7	25-46-7MSCV	SC	FKM
25	46	7	25-46-7MTCN	TC	NBR
25	46	7	25-46-7MVCN	VC	NBR
25	47	7	25-47-7MSCN	SC	NBR
25	47	7	25-47-7MSCV	SC	FKM
25	47	7	25-47-7MTCN	TC	NBR
25	47	7	25-47-7MVCN	VC	NBR
25	47	7	25-47-7MVCN	VC	NBR
25	47	7	25-47-7MVCN	VC	NBR
25	47	10	M 9257 H1L5	LUP	NBR
25	48	7	25-48-7MSCN	SC	NBR
25	48	7	25-48-7MSCV	SC	FKM
25	48	7	25-48-7MTCN	TC	NBR
25	48	7	25-48-7MVCN	VC	NBR
25	50	10	25-50-10MSCN	SC	NBR
25	50	10	25-50-10MSCV	SC	FKM
25	50	10	25-50-10MTCN	TC	NBR
25	50	10	25-50-10MVCN	VC	NBR
25	52	6	M 10335 H1L5	LUP	NBR
25	52	7	25-52-7MSCN	SC	NBR
25	52	7	25-52-7MSCV	SC	FKM
25	52	7	25-52-7MTCN	TC	NBR
25	52	7	25-52-7MVCN	VC	NBR
25	52	9	M 60019 H1L5	LDS	NBR
25	52	10	M 11425 H1L5	LPD	NBR
26	35	5	M 6726 H1L5	LA	NBR
26	36	7	26-36-7MSCN	SC	NBR
26	36	7	26-36-7MSCV	SC	FKM
26	36	7	26-36-7MTCN	TC	NBR
26	36	7	26-36-7MVCN	VC	NBR
26	37	7	26-37-7MSCN	SC	NBR



See Section 4 for seal type description. For FlexiSeal Listings see Page C-22.

03/03/06



Rotary Lip Seal Metric Sizes

C

Shaft Dia.	Bore Dia.	Seal Width	Parker Part Number	Seal Type	Material
26	37	7	26-37-7MSCV	SC	FKM
26	37	7	26-37-7MTCN	TC	NBR
26	37	7	26-37-7MVCN	VC	NBR
26	38	5	26-38-5MSCN	SC	NBR
26	38	5	26-38-5MSCV	SC	FKM
26	38	5	26-38-5MTCN	TC	NBR
26	38	5	26-38-5MVCN	VC	NBR
26	38	6	M 10751 H1L5	LUP	NBR
26	38	6	M 16676 H1L7	P	NBR
26	38	6	M 10615 H1L7	SS	NBR
26	38	10	M 17694 H1L5	LDS	NBR
26	40	7	26-40-7MSCN	SC	NBR
26	40	7	26-40-7MSCV	SC	FKM
26	40	7	26-40-7MTCN	TC	NBR
26	40	7	26-40-7MVCN	VC	NBR
26	42	7	26-42-7MSCN	SC	NBR
26	42	7	26-42-7MSCV	SC	FKM
26	42	7	26-42-7MTCN	TC	NBR
26	42	7	26-42-7MVCN	VC	NBR
26	47	7	26-47-7MSCN	SC	NBR
26	47	7	26-47-7MSCV	SC	FKM
26	47	7	26-47-7MTCN	TC	NBR
26	47	7	26-47-7MVCN	VC	NBR
26	48	7	26-48-7MSCN	SC	NBR
26	48	7	26-48-7MSCV	SC	FKM
26	48	7	26-48-7MTCN	TC	NBR
26	48	7	26-48-7MVCN	VC	NBR
26	50	10	26-50-10MSCN	SC	NBR
26	50	10	26-50-10MSCV	SC	FKM
26	50	10	26-50-10MTCN	TC	NBR
26	50	10	26-50-10MVCN	VC	NBR
26	62	9	26-62-9MSCN	SC	NBR
26	62	9	26-62-9MSCV	SC	FKM
26	62	9	26-62-9MTCN	TC	NBR
26	62	9	26-62-9MVCN	VC	NBR
26	72	10	26-72-10MSCN	SC	NBR
26	72	10	26-72-10MSCV	SC	FKM
26	72	10	26-72-10MTCN	TC	NBR
26	72	10	26-72-10MVCN	VC	NBR
27	37	7	27-37-7MSCN	SC	NBR
27	37	7	27-37-7MSCV	SC	FKM
27	37	7	27-37-7MTCN	TC	NBR
27	37	7	27-37-7MVCN	VC	NBR
27	40	8	27-40-8MSCN	SC	NBR
27	40	8	27-40-8MSCV	SC	FKM
27	40	8	27-40-8MTCN	TC	NBR
27	40	8	27-40-8MVCN	VC	NBR
27	42	7	27-42-7MSCN	SC	NBR
27	42	7	27-42-7MSCV	SC	FKM
27	42	7	27-42-7MTCN	TC	NBR
27	42	7	27-42-7MVCN	VC	NBR
27	43	8	27-43-8MSCN	SC	NBR
27	43	8	27-43-8MSCV	SC	FKM
27	43	8	27-43-8MTCN	TC	NBR
27	43	8	27-43-8MVCN	VC	NBR
27	45	9	27-45-9MSCN	SC	NBR
27	45	9	27-45-9MSCV	SC	FKM
27	45	9	27-45-9MTCN	TC	NBR
27	45	9	27-45-9MVCN	VC	NBR
27	54	11	M 13243 H1L5	LDS	NBR
27	54	13	M 10433 H1L5	LPD	NBR
28	35	5	28-35-5MSCN	SC	NBR
28	35	5	28-35-5MSCV	SC	FKM
28	35	5	28-35-5MTCN	TC	NBR
28	35	5	28-35-5MVCN	VC	NBR
28	37	5	28-37-5MSCN	SC	NBR

Shaft Dia.	Bore Dia.	Seal Width	Parker Part Number	Seal Type	Material
28	37	5	28-37-5MSCV	SC	FKM
28	37	5	28-37-5MTCN	TC	NBR
28	37	5	28-37-5MVCN	VC	NBR
28	38	7	28-38-7MSCN	SC	NBR
28	38	7	28-38-7MSCV	SC	FKM
28	38	7	28-38-7MTCN	TC	NBR
28	38	7	28-38-7MVCN	VC	NBR
28	40	7	28-40-7MSCN	SC	NBR
28	40	7	28-40-7MSCV	SC	FKM
28	40	7	28-40-7MTCN	TC	NBR
28	40	7	28-40-7MVCN	VC	NBR
28	41	7	28-41-7MSCN	SC	NBR
28	41	7	28-41-7MSCV	SC	FKM
28	41	7	28-41-7MTCN	TC	NBR
28	41	7	28-41-7MVCN	VC	NBR
28	42	7	28-42-7MSCN	SC	NBR
28	42	7	28-42-7MSCV	SC	FKM
28	42	7	28-42-7MTCN	TC	NBR
28	42	7	28-42-7MVCN	VC	NBR
28	43	7	28-43-7MSCN	SC	NBR
28	43	7	28-43-7MSCV	SC	FKM
28	43	7	28-43-7MTCN	TC	NBR
28	43	7	28-43-7MVCN	VC	NBR
28	45	7	28-45-7MSCN	SC	NBR
28	45	7	28-45-7MSCV	SC	FKM
28	45	7	28-45-7MTCN	TC	NBR
28	45	7	28-45-7MVCN	VC	NBR
28	48	7	28-48-7MSCN	SC	NBR
28	48	7	28-48-7MSCV	SC	FKM
28	48	7	28-48-7MTCN	TC	NBR
28	48	7	28-48-7MVCN	VC	NBR
28	50	8	28-50-8MSCN	SC	NBR
28	50	8	28-50-8MSCV	SC	FKM
28	50	8	28-50-8MTCN	TC	NBR
28	50	8	28-50-8MVCN	VC	NBR
28	52	7	28-52-7MSCN	SC	NBR
28	52	7	28-52-7MSCV	SC	FKM
28	52	7	28-52-7MTCN	TC	NBR
28	52	7	28-52-7MVCN	VC	NBR
28	60	10	28-60-10MSCN	SC	NBR
28	60	10	28-60-10MSCV	SC	FKM
28	60	10	28-60-10MTCN	TC	NBR
28	60	10	28-60-10MVCN	VC	NBR
28	62	10	28-62-10MSCN	SC	NBR
28	62	10	28-62-10MSCV	SC	FKM
28	62	10	28-62-10MTCN	TC	NBR
28	62	10	28-62-10MVCN	VC	NBR
29	35	6	M 12313 ALLL7	P	NBR
29	35	6	M 13187 H3L8	P	CR
29	35	6	M 16195 H1L7	P	NBR
29	46	10	29-46-10MSCN	SC	NBR
29	46	10	29-46-10MSCV	SC	FKM
29	46	10	29-46-10MTCN	TC	NBR
29	46	10	29-46-10MVCN	VC	NBR
29	47	13	M 9714 H1L5	LUP	NBR
29	50	10	29-50-10MSCN	SC	NBR
29	50	10	29-50-10MSCV	SC	FKM
29	50	10	29-50-10MTCN	TC	NBR
29	50	10	29-50-10MVCN	VC	NBR
29	52	9	M 9306 H1L5	LPD	NBR
29	52	11	M 15452 H1L5	LPD	NBR
29	72	13	M 9065 H1L5	LUP	NBR
30	40	7	30-40-7MSCN	SC	NBR
30	40	7	30-40-7MSCV	SC	FKM
30	40	7	30-40-7MTCN	TC	NBR
30	40	7	30-40-7MVCN	VC	NBR

See Section 4 for seal type description. For FlexiSeal Listings see Page C-22.

03/03/06



Rotary Lip Seal Metric Sizes

Shaft Dia.	Bore Dia.	Seal Width	Parker Part Number	Seal Type	Material
30	41	7	30-41-7MSCN	SC	NBR
30	41	7	30-41-7MSCV	SC	FKM
30	41	7	30-41-7MTCN	TC	NBR
30	41	7	30-41-7MVCN	VC	NBR
30	42	7	30-42-7MSCN	SC	NBR
30	42	7	30-42-7MSCV	SC	FKM
30	42	7	M 30056 H1L5	SS	NBR
30	42	7	M 30056 H5L89	SS	FKM
30	42	7	30-42-7MTCN	TC	NBR
30	42	7	30-42-7MVCN	VC	NBR
30	42	9	M 15194 H1L7	P	NBR
30	44	7	30-44-7MSCN	SC	NBR
30	44	7	30-44-7MSCV	SC	FKM
30	44	7	30-44-7MTCN	TC	NBR
30	44	7	30-44-7MVCN	VC	NBR
30	45	7	30-45-7MSCN	SC	NBR
30	45	7	30-45-7MSCV	SC	FKM
30	45	7	30-45-7MTCN	TC	NBR
30	45	7	30-45-7MVCN	VC	NBR
30	45	10	M 17236 H1L5	LUP	NBR
30	46	7	30-46-7MSCN	SC	NBR
30	46	7	30-46-7MSCV	SC	FKM
30	46	7	30-46-7MTCN	TC	NBR
30	46	7	30-46-7MVCN	VC	NBR
30	46	8	M 9730 H1L5	LUP	NBR
30	47	7	30-47-7MSCN	SC	NBR
30	47	7	30-47-7MSCV	SC	FKM
30	47	7	30-47-7MTCN	TC	NBR
30	47	7	30-47-7MVCN	VC	NBR
30	47	10	M 15129 H1L5	LPD	NBR
30	48	7	30-48-7MSCN	SC	NBR
30	48	7	30-48-7MSCV	SC	FKM
30	48	7	30-48-7MTCN	TC	NBR
30	48	7	30-48-7MVCN	VC	NBR
30	50	8	30-50-8MSCN	SC	NBR
30	50	8	30-50-8MSCV	SC	FKM
30	50	8	30-50-8MTCN	TC	NBR
30	50	8	30-50-8MVCN	VC	NBR
30	50	10	M 15314 H1L5	RPD	NBR
30	52	7	M 30058 H1L5	LUP	NBR
30	52	7	30-52-7MSCN	SC	NBR
30	52	7	30-52-7MSCV	SC	FKM
30	52	7	30-52-7MTCN	TC	NBR
30	52	7	30-52-7MVCN	VC	NBR
30	52	10	M 15508 H1L5	LUP	NBR
30	54	9	M 16465 H1L5	LDS	NBR
30	55	7	30-55-7MSCN	SC	NBR
30	55	7	30-55-7MSCV	SC	FKM
30	55	7	30-55-7MTCN	TC	NBR
30	55	7	30-55-7MVCN	VC	NBR
30	56	10	30-56-10MSCN	SC	NBR
30	56	10	30-56-10MSCV	SC	FKM
30	56	10	30-56-10MTCN	TC	NBR
30	56	10	30-56-10MVCN	VC	NBR
30	58	10	30-58-10MSCN	SC	NBR
30	58	10	30-58-10MSCV	SC	FKM
30	58	10	30-58-10MTCN	TC	NBR
30	58	10	30-58-10MVCN	VC	NBR
30	60	6	M 7212 H1L5	LUP	NBR
30	60	10	30-60-10MSCN	SC	NBR
30	60	10	30-60-10MSCV	SC	FKM
30	60	10	30-60-10MTCN	TC	NBR
30	60	10	30-60-10MVCN	VC	NBR
30	62	6	M 5204 H1L5	LUP	NBR
30	62	6	M 6474 H1L7	SS	NBR
30	62	7	30-62-7MSCN	SC	NBR

Shaft Dia.	Bore Dia.	Seal Width	Parker Part Number	Seal Type	Material
30	62	7	30-62-7MSCV	SC	FKM
30	62	7	30-62-7MTCN	TC	NBR
30	62	7	30-62-7MVCN	VC	NBR
30	62	9	M 13286 H1L5	LDS	NBR
30	62	12	M 7011 H1L5	LUP	NBR
30	65	10	30-65-10MSCN	SC	NBR
30	65	10	30-65-10MSCV	SC	FKM
30	65	10	30-65-10MTCN	TC	NBR
30	65	10	30-65-10MVCN	VC	NBR
30	72	8	30-72-8MSCN	SC	NBR
30	72	8	30-72-8MSCV	SC	FKM
30	72	8	30-72-8MTCN	TC	NBR
30	72	8	30-72-8MVCN	VC	NBR
30	72	9	M 16677 H1L5	SS	NBR
30	72	9	M 16677 H1L7	SS	NBR
30	75	10	30-75-10MSCN	SC	NBR
30	75	10	30-75-10MSCV	SC	FKM
30	75	10	30-75-10MTCN	TC	NBR
30	75	10	30-75-10MVCN	VC	NBR
31	49	7	31-49-7MSCN	SC	NBR
31	49	7	31-49-7MSCV	SC	FKM
31	49	7	31-49-7MTCN	TC	NBR
31	49	7	31-49-7MVCN	VC	NBR
31	52	6	31-52-6MSCN	SC	NBR
31	52	6	31-52-6MSCV	SC	FKM
31	52	6	31-52-6MTCN	TC	NBR
31	52	6	31-52-6MVCN	VC	NBR
32	40	7	32-40-7MSCN	SC	NBR
32	40	7	32-40-7MSCV	SC	FKM
32	40	7	32-40-7MTCN	TC	NBR
32	40	7	32-40-7MVCN	VC	NBR
32	42	7	32-42-7MSCN	SC	NBR
32	42	7	32-42-7MSCV	SC	FKM
32	42	7	32-42-7MTCN	TC	NBR
32	42	7	32-42-7MVCN	VC	NBR
32	43	7	32-43-7MSCN	SC	NBR
32	43	7	32-43-7MSCV	SC	FKM
32	43	7	32-43-7MTCN	TC	NBR
32	43	7	32-43-7MVCN	VC	NBR
32	44	7	32-44-7MSCN	SC	NBR
32	44	7	32-44-7MSCV	SC	FKM
32	44	7	32-44-7MTCN	TC	NBR
32	44	7	32-44-7MVCN	VC	NBR
32	44	9	M 15859 H1L7	P	NBR
32	45	6	32-45-6MSCN	SC	NBR
32	45	6	32-45-6MSCV	SC	FKM
32	45	6	32-45-6MTCN	TC	NBR
32	45	6	32-45-6MVCN	VC	NBR
32	45	8	M 30059 H1L5	SS	NBR
32	46	7	32-46-7MSCN	SC	NBR
32	46	7	32-46-7MSCV	SC	FKM
32	46	7	32-46-7MTCN	TC	NBR
32	46	7	32-46-7MVCN	VC	NBR
32	47	7	32-47-7MSCN	SC	NBR
32	47	7	32-47-7MSCV	SC	FKM
32	47	7	32-47-7MTCN	TC	NBR
32	47	7	32-47-7MVCN	VC	NBR
32	48	7	32-48-7MSCN	SC	NBR
32	48	7	32-48-7MSCV	SC	FKM
32	48	7	32-48-7MTCN	TC	NBR
32	48	7	32-48-7MVCN	VC	NBR
32	48	9	M 13300 H1L7	P	NBR
32	50	7	32-50-7MSCN	SC	NBR
32	50	7	32-50-7MSCV	SC	FKM
32	50	7	32-50-7MTCN	TC	NBR
32	50	7	32-50-7MVCN	VC	NBR



See Section 4 for seal type description. For FlexiSeal Listings see Page C-22.

03/03/06



Rotary Lip Seal Metric Sizes

Shaft Dia.	Bore Dia.	Seal Width	Parker Part Number	Seal Type	Material
35	55	8	35-55-8MVCN	VC	NBR
35	55	8	35-55-8MVCN	VC	NBR
35	56	10	M 11751 H1L5	LPD	NBR
35	56	10	35-56-10MSCN	SC	NBR
35	56	10	35-56-10MSCV	SC	FKM
35	56	10	35-56-10MTCN	TC	NBR
35	56	10	35-56-10MVCN	VC	NBR
35	57	6	M 11053 H1L5	LPD	NBR
35	58	10	35-58-10MSCN	SC	NBR
35	58	10	35-58-10MSCV	SC	FKM
35	58	10	35-58-10MTCN	TC	NBR
35	58	10	35-58-10MVCN	VC	NBR
35	60	10	35-60-10MSCN	SC	NBR
35	60	10	35-60-10MSCV	SC	FKM
35	60	10	35-60-10MTCN	TC	NBR
35	60	10	35-60-10MVCN	VC	NBR
35	62	6	35-62-6MSCN	SC	NBR
35	62	6	35-62-6MSCV	SC	FKM
35	62	6	35-62-6MTCN	TC	NBR
35	62	6	35-62-6MVCN	VC	NBR
35	62	7	35-62-7MSCN	SC	NBR
35	62	7	35-62-7MSCV	SC	FKM
35	62	7	35-62-7MTCN	TC	NBR
35	62	7	35-62-7MVCN	VC	NBR
35	62	8	M 9733 H1L5	LPD	NBR
35	62	11	M 10524 H1L5	LPD	NBR
35	70	10	35-70-10MSCN	SC	NBR
35	70	10	35-70-10MSCV	SC	FKM
35	70	10	35-70-10MTCN	TC	NBR
35	70	10	35-70-10MVCN	VC	NBR
35	72	6	M 17653 H1L5	LUP	NBR
35	72	7	35-72-7MSCN	SC	NBR
35	72	7	35-72-7MSCV	SC	FKM
35	72	7	35-72-7MTCN	TC	NBR
35	72	7	35-72-7MVCN	VC	NBR
35	72	9	M 13287 H1L5	LDS	NBR
35	80	8	M 12020 H1L5	LUP	NBR
35	80	8	35-80-8MSCN	SC	NBR
35	80	8	35-80-8MSCV	SC	FKM
35	80	8	35-80-8MTCN	TC	NBR
35	80	8	35-80-8MVCN	VC	NBR
36	47	7	36-47-7MSCN	SC	NBR
36	47	7	36-47-7MSCV	SC	FKM
36	47	7	36-47-7MTCN	TC	NBR
36	47	7	36-47-7MVCN	VC	NBR
36	49	7	36-49-7MSCN	SC	NBR
36	49	7	36-49-7MSCV	SC	FKM
36	49	7	36-49-7MTCN	TC	NBR
36	49	7	36-49-7MVCN	VC	NBR
36	50	7	36-50-7MSCN	SC	NBR
36	50	7	36-50-7MSCV	SC	FKM
36	50	7	36-50-7MTCN	TC	NBR
36	50	7	36-50-7MVCN	VC	NBR
36	52	7	36-52-7MSCN	SC	NBR
36	52	7	36-52-7MSCV	SC	FKM
36	52	7	36-52-7MTCN	TC	NBR
36	52	7	36-52-7MVCN	VC	NBR
36	54	7	36-54-7MSCN	SC	NBR
36	54	7	36-54-7MSCV	SC	FKM
36	54	7	36-54-7MTCN	TC	NBR
36	54	7	36-54-7MVCN	VC	NBR
36	58	8	36-58-8MSCN	SC	NBR
36	58	8	36-58-8MSCV	SC	FKM
36	58	8	36-58-8MTCN	TC	NBR
36	58	8	36-58-8MVCN	VC	NBR
36	62	7	36-62-7MSCN	SC	NBR

Shaft Dia.	Bore Dia.	Seal Width	Parker Part Number	Seal Type	Material
36	62	7	36-62-7MSCV	SC	FKM
36	62	7	36-62-7MTCN	TC	NBR
36	62	7	36-62-7MVCN	VC	NBR
36	68	10	36-68-10MSCN	SC	NBR
36	68	10	36-68-10MSCV	SC	FKM
36	68	10	36-68-10MTCN	TC	NBR
36	68	10	36-68-10MVCN	VC	NBR
37	53	7	37-53-7MSCN	SC	NBR
37	53	7	37-53-7MSCV	SC	FKM
37	53	7	37-53-7MTCN	TC	NBR
37	53	7	37-53-7MVCN	VC	NBR
37	54	9	M 7047 H1L5	LA	NBR
37	54	11	M 7216 H1L5	LUP	NBR
37	54	11	M 12894 H1L7	SS	NBR
37	62	13	M 7346 H1L5	LPD	NBR
37	64	13	37-64-13MSCN	SC	NBR
37	64	13	37-64-13MSCV	SC	FKM
37	64	13	37-64-13MTCN	TC	NBR
37	64	13	37-64-13MVCN	VC	NBR
37	73	9	M 11809 H1L5	LUP	NBR
37	80	6	M 60012 H1L5	LDS	NBR
38	45	7	M 19894 H1L5	SS	NBR
38	50	7	38-50-7MSCN	SC	NBR
38	50	7	38-50-7MSCV	SC	FKM
38	50	7	38-50-7MTCN	TC	NBR
38	50	7	38-50-7MVCN	VC	NBR
38	52	7	38-52-7MSCN	SC	NBR
38	52	7	38-52-7MSCV	SC	FKM
38	52	7	38-52-7MTCN	TC	NBR
38	52	7	38-52-7MVCN	VC	NBR
38	54	10	38-54-10MSCN	SC	NBR
38	54	10	38-54-10MSCV	SC	FKM
38	54	10	38-54-10MTCN	TC	NBR
38	54	10	38-54-10MVCN	VC	NBR
38	54	11	M 6679 H1L5	LUP	NBR
38	55	7	38-55-7MSCN	SC	NBR
38	55	7	38-55-7MSCV	SC	FKM
38	55	7	38-55-7MTCN	TC	NBR
38	55	7	38-55-7MVCN	VC	NBR
38	56	10	38-56-10MSCN	SC	NBR
38	56	10	38-56-10MSCV	SC	FKM
38	56	10	38-56-10MTCN	TC	NBR
38	56	10	38-56-10MVCN	VC	NBR
38	58	8	38-58-8MSCN	SC	NBR
38	58	8	38-58-8MSCV	SC	FKM
38	58	8	38-58-8MTCN	TC	NBR
38	58	8	38-58-8MVCN	VC	NBR
38	60	10	38-60-10MSCN	SC	NBR
38	60	10	38-60-10MSCV	SC	FKM
38	60	10	38-60-10MTCN	TC	NBR
38	60	10	38-60-10MVCN	VC	NBR
38	62	7	38-62-7MSCN	SC	NBR
38	62	7	38-62-7MSCV	SC	FKM
38	62	7	38-62-7MTCN	TC	NBR
38	62	7	38-62-7MVCN	VC	NBR
38	65	10	38-65-10MSCN	SC	NBR
38	65	10	38-65-10MSCV	SC	FKM
38	65	10	38-65-10MTCN	TC	NBR
38	65	10	38-65-10MVCN	VC	NBR
38	70	11	M 5696 H1L5	LUP	NBR
38	72	8	38-72-8MSCN	SC	NBR
38	72	8	38-72-8MSCV	SC	FKM
38	72	8	38-72-8MTCN	TC	NBR
38	72	8	38-72-8MVCN	VC	NBR
38	72	13	M 11603 H1L5	LA	NBR
38	72	13	M 6062 H1L5 PTF	LPD	N/P



See Section 4 for seal type description. For FlexiSeal Listings see Page C-22.

03/03/06



Rotary Lip Seal Metric Sizes

C

Shaft Dia.	Bore Dia.	Seal Width	Parker Part Number	Seal Type	Material
38	74	11	38-74-11MSCN	SC	NBR
38	74	11	38-74-11MSCV	SC	FKM
38	74	11	38-74-11MTCN	TC	NBR
38	74	11	38-74-11MVCN	VC	NBR
40	52	7	40-52-7MSCN	SC	NBR
40	52	7	40-52-7MSCV	SC	FKM
40	52	7	40-52-7MTCN	TC	NBR
40	52	7	40-52-7MVCN	VC	NBR
40	54	7	40-54-7MSCN	SC	NBR
40	54	7	40-54-7MSCV	SC	FKM
40	54	7	40-54-7MTCN	TC	NBR
40	54	7	40-54-7MVCN	VC	NBR
40	55	6	M 19811 H1L5	LUP	NBR
40	55	7	40-55-7MSCN	SC	NBR
40	55	7	40-55-7MSCV	SC	FKM
40	55	7	40-55-7MTCN	TC	NBR
40	55	7	40-55-7MVCN	VC	NBR
40	56	8	40-56-8MSCN	SC	NBR
40	56	8	40-56-8MSCV	SC	FKM
40	56	8	40-56-8MTCN	TC	NBR
40	56	8	40-56-8MVCN	VC	NBR
40	56	9	M 14709 H1L7	P	NBR
40	56	10	M 14577 H1L5	LPD	NBR
40	58	8	40-58-8MSCN	SC	NBR
40	58	8	40-58-8MSCV	SC	FKM
40	58	8	40-58-8MTCN	TC	NBR
40	58	8	40-58-8MVCN	VC	NBR
40	60	7	40-60-7MSCN	SC	NBR
40	60	7	40-60-7MSCV	SC	FKM
40	60	7	40-60-7MTCN	TC	NBR
40	60	7	40-60-7MVCN	VC	NBR
40	62	5	40-62-5MSCN	SC	NBR
40	62	5	40-62-5MSCV	SC	FKM
40	62	5	40-62-5MTCN	TC	NBR
40	62	5	40-62-5MVCN	VC	NBR
40	62	8	M 30038 H1L5	LUP	NBR
40	62	11	M 11514 H1L5	LPD	NBR
40	62	11	M 3691 H1L5	RPD	NBR
40	64	10	40-64-10MSCN	SC	NBR
40	64	10	40-64-10MSCV	SC	FKM
40	64	10	40-64-10MTCN	TC	NBR
40	64	10	40-64-10MVCN	VC	NBR
40	65	7	40-65-7MSCN	SC	NBR
40	65	7	40-65-7MSCV	SC	FKM
40	65	7	40-65-7MTCN	TC	NBR
40	65	7	40-65-7MVCN	VC	NBR
40	68	6	40-68-6MSCN	SC	NBR
40	68	6	40-68-6MSCV	SC	FKM
40	68	6	40-68-6MTCN	TC	NBR
40	68	6	40-68-6MVCN	VC	NBR
40	68	8	M 19858 H1L5	LUP	NBR
40	68	11	M 18329 H1L5	LUP	NBR
40	70	12	40-70-12MSCN	SC	NBR
40	70	12	40-70-12MSCV	SC	FKM
40	70	12	40-70-12MTCN	TC	NBR
40	70	12	40-70-12MVCN	VC	NBR
40	72	7	40-72-7MSCN	SC	NBR
40	72	7	40-72-7MSCV	SC	FKM
40	72	7	40-72-7MTCN	TC	NBR
40	72	7	40-72-7MVCN	VC	NBR
40	75	8	40-75-8MSCN	SC	NBR
40	75	8	40-75-8MSCV	SC	FKM
40	75	8	40-75-8MTCN	TC	NBR
40	75	8	40-75-8MVCN	VC	NBR
40	76	8	40-76-8MSCN	SC	NBR
40	76	8	40-76-8MSCV	SC	FKM

Shaft Dia.	Bore Dia.	Seal Width	Parker Part Number	Seal Type	Material
40	76	8	40-76-8MTCN	TC	NBR
40	76	8	40-76-8MVCN	VC	NBR
40	80	7	40-80-7MSCN	SC	NBR
40	80	7	40-80-7MSCV	SC	FKM
40	80	7	40-80-7MTCN	TC	NBR
40	80	7	40-80-7MVCN	VC	NBR
40	80	9	M 13285 H1L5	LDS	NBR
40	85	10	40-85-10MSCN	SC	NBR
40	85	10	40-85-10MSCV	SC	FKM
40	85	10	40-85-10MTCN	TC	NBR
40	85	10	40-85-10MVCN	VC	NBR
40	90	9	M 10190 H1L5	LPD	NBR
41	51	8	M 12318 ALLL7	P	NBR
41	62	10	M 12007 H1L5	LPD	NBR
41	62	10	M 12007 H5L16	LPD	FKM
41	62	10	M 7365 H1L5	LUP	NBR
41	62	13	M 13517 H1L5	LDS	NBR
41	69	9	M 19218 H1L5	LDS	NBR
41	73	13	M 9849 H1L5	LUP	NBR
42	52	7	42-52-7MSCN	SC	NBR
42	52	7	42-52-7MSCV	SC	FKM
42	52	7	42-52-7MTCN	TC	NBR
42	52	7	42-52-7MVCN	VC	NBR
42	55	7	42-55-7MSCN	SC	NBR
42	55	7	42-55-7MSCV	SC	FKM
42	55	7	42-55-7MTCN	TC	NBR
42	55	7	42-55-7MVCN	VC	NBR
42	56	7	42-56-7MSCN	SC	NBR
42	56	7	42-56-7MSCV	SC	FKM
42	56	7	42-56-7MTCN	TC	NBR
42	56	7	42-56-7MVCN	VC	NBR
42	58	8	42-58-8MSCN	SC	NBR
42	58	8	42-58-8MSCV	SC	FKM
42	58	8	42-58-8MTCN	TC	NBR
42	58	8	42-58-8MVCN	VC	NBR
42	60	7	42-60-7MSCN	SC	NBR
42	60	7	42-60-7MSCV	SC	FKM
42	60	7	42-60-7MTCN	TC	NBR
42	60	7	42-60-7MVCN	VC	NBR
42	62	7	42-62-7MSCN	SC	NBR
42	62	7	42-62-7MSCV	SC	FKM
42	62	7	42-62-7MTCN	TC	NBR
42	62	7	42-62-7MVCN	VC	NBR
42	64	8	42-64-8MSCN	SC	NBR
42	64	8	42-64-8MSCV	SC	FKM
42	64	8	42-64-8MTCN	TC	NBR
42	64	8	42-64-8MVCN	VC	NBR
42	65	9	42-65-9MSCN	SC	NBR
42	65	9	42-65-9MSCV	SC	FKM
42	65	9	42-65-9MTCN	TC	NBR
42	65	9	42-65-9MVCN	VC	NBR
42	70	10	42-70-10MSCN	SC	NBR
42	70	10	42-70-10MSCV	SC	FKM
42	70	10	42-70-10MTCN	TC	NBR
42	70	10	42-70-10MVCN	VC	NBR
42	72	8	42-72-8MSCN	SC	NBR
42	72	8	42-72-8MSCV	SC	FKM
42	72	8	42-72-8MTCN	TC	NBR
42	72	8	42-72-8MVCN	VC	NBR
42	75	10	42-75-10MSCN	SC	NBR
42	75	10	42-75-10MSCV	SC	FKM
42	75	10	42-75-10MTCN	TC	NBR
42	75	10	42-75-10MVCN	VC	NBR
42	76	12	42-76-12MSCN	SC	NBR
42	76	12	42-76-12MSCV	SC	FKM
42	76	12	42-76-12MTCN	TC	NBR

See Section 4 for seal type description. For FlexiSeal Listings see Page C-22.

03/03/06



Rotary Lip Seal Metric Sizes

Shaft Dia.	Bore Dia.	Seal Width	Parker Part Number	Seal Type	Material
42	76	12	42-76-12MVCN	VC	NBR
42	78	10	42-78-10MSCN	SC	NBR
42	78	10	42-78-10MSCV	SC	FKM
42	78	10	42-78-10MTCN	TC	NBR
42	78	10	42-78-10MVCN	VC	NBR
43	54	7	43-54-7MSCN	SC	NBR
43	54	7	43-54-7MSCV	SC	FKM
43	54	7	43-54-7MTCN	TC	NBR
43	54	7	43-54-7MVCN	VC	NBR
43	62	8	43-62-8MSCN	SC	NBR
43	62	8	43-62-8MSCV	SC	FKM
43	62	8	43-62-8MTCN	TC	NBR
43	62	8	43-62-8MVCN	VC	NBR
43	62	9	M 5690 H1L5	LPD	NBR
44	60	4	44-60-4MSCN	SC	NBR
44	60	4	44-60-4MSCV	SC	FKM
44	60	4	44-60-4MTCN	TC	NBR
44	60	4	44-60-4MVCN	VC	NBR
44	62	8	44-62-8MSCN	SC	NBR
44	62	8	44-62-8MSCV	SC	FKM
44	62	8	44-62-8MTCN	TC	NBR
44	62	8	44-62-8MVCN	VC	NBR
44	70	12	44-70-12MSCN	SC	NBR
44	70	12	44-70-12MSCV	SC	FKM
44	70	12	44-70-12MTCN	TC	NBR
44	70	12	44-70-12MVCN	VC	NBR
44	73	9	M 18036 H1L5	LUP	NBR
44	73	11	M 16371 H1L5	LUP	NBR
44	73	13	M 9947 H1L5	LUP	NBR
44	81	13	M 8461 H1L5	LUP	NBR
44	92	13	M 10112 H1L5	LPD	NBR
45	54	5	M 8854 H1L7	SS	NBR
45	54	8	M 12319 ALLL7	P	NBR
45	55	6	45-55-6MSCN	SC	NBR
45	55	6	45-55-6MSCV	SC	FKM
45	55	6	45-55-6MTCN	TC	NBR
45	55	6	45-55-6MVCN	VC	NBR
45	57	9	45-57-9MSCN	SC	NBR
45	57	9	45-57-9MSCV	SC	FKM
45	57	9	45-57-9MTCN	TC	NBR
45	57	9	45-57-9MVCN	VC	NBR
45	59	7	45-59-7MSCN	SC	NBR
45	59	7	45-59-7MSCV	SC	FKM
45	59	7	45-59-7MTCN	TC	NBR
45	59	7	45-59-7MVCN	VC	NBR
45	60	7	M 15339 H1L5	LPD	NBR
45	60	7	45-60-7MSCN	SC	NBR
45	60	7	45-60-7MSCV	SC	FKM
45	60	7	45-60-7MTCN	TC	NBR
45	60	7	45-60-7MVCN	VC	NBR
45	62	7	45-62-7MSCN	SC	NBR
45	62	7	45-62-7MSCV	SC	FKM
45	62	7	45-62-7MTCN	TC	NBR
45	62	7	45-62-7MVCN	VC	NBR
45	62	9	M 18419 H5L89	LDS	FKM
45	62	9	M 9799 H1L5	LPD	NBR
45	65	8	45-65-8MSCN	SC	NBR
45	65	8	45-65-8MSCV	SC	FKM
45	65	8	45-65-8MTCN	TC	NBR
45	65	8	45-65-8MVCN	VC	NBR
45	65	11	M 11812 H1L5	LPDW	NBR
45	68	10	45-68-10MSCN	SC	NBR
45	68	10	45-68-10MSCV	SC	FKM
45	68	10	45-68-10MTCN	TC	NBR
45	68	10	45-68-10MVCN	VC	NBR
45	70	10	45-70-10MSCN	SC	NBR

Shaft Dia.	Bore Dia.	Seal Width	Parker Part Number	Seal Type	Material
45	70	10	45-70-10MSCV	SC	FKM
45	70	10	45-70-10MTCN	TC	NBR
45	70	10	45-70-10MVCN	VC	NBR
45	70	13	M 5633 H1L5	RPD	NBR
45	72	8	45-72-8MSCV	SC	NBR
45	72	8	45-72-8MSCV	SC	FKM
45	72	8	45-72-8MTCN	TC	NBR
45	72	8	45-72-8MVCN	VC	NBR
45	72	10	M 13066 H1L5	LPD	NBR
45	73	17	M 18189 H1L5	LDS	NBR
45	75	6	M 60018 H1L5	LDS	NBR
45	75	10	45-75-10MSCN	SC	NBR
45	75	10	45-75-10MSCV	SC	FKM
45	75	10	45-75-10MTCN	TC	NBR
45	75	10	45-75-10MVCN	VC	NBR
45	78	11	M 0045 9302	SPLIT	NBR
45	80	10	45-80-10MSCN	SC	NBR
45	80	10	45-80-10MSCV	SC	FKM
45	80	10	45-80-10MTCN	TC	NBR
45	80	10	45-80-10MVCN	VC	NBR
45	85	10	45-85-10MSCN	SC	NBR
45	85	10	45-85-10MSCV	SC	FKM
45	85	10	45-85-10MTCN	TC	NBR
45	85	10	45-85-10MVCN	VC	NBR
45	90	10	45-90-10MSCN	SC	NBR
45	90	10	45-90-10MSCV	SC	FKM
45	90	10	45-90-10MTCN	TC	NBR
45	90	10	45-90-10MVCN	VC	NBR
45	100	13	M 9393 H1L5	LUP	NBR
46	62	6	M 10317 H1L5	LUP	NBR
46	73	13	M 13922 H1L5	LDS	NBR
47	73	12	M 8510 H1L5	LUP	NBR
48	60	9	48-60-9MSCV	SC	NBR
48	60	9	48-60-9MSCV	SC	FKM
48	60	9	48-60-9MTCN	TC	NBR
48	60	9	48-60-9MVCN	VC	NBR
48	62	7	48-62-7MSCN	SC	NBR
48	62	7	48-62-7MSCV	SC	FKM
48	62	7	48-62-7MTCN	TC	NBR
48	62	7	48-62-7MVCN	VC	NBR
48	62	8	M 16514 H1L5 PT	LUP	N/P
48	65	9	48-65-9MSCN	SC	NBR
48	65	9	48-65-9MSCV	SC	FKM
48	65	9	48-65-9MTCN	TC	NBR
48	65	9	48-65-9MVCN	VC	NBR
48	68	10	48-68-10MSCN	SC	NBR
48	68	10	48-68-10MSCV	SC	FKM
48	68	10	48-68-10MTCN	TC	NBR
48	68	10	48-68-10MVCN	VC	NBR
48	70	9	48-70-9MSCV	SC	NBR
48	70	9	48-70-9MSCV	SC	FKM
48	70	9	48-70-9MTCN	TC	NBR
48	70	9	48-70-9MVCN	VC	NBR
48	72	8	48-72-8MSCV	SC	NBR
48	72	8	48-72-8MSCV	SC	FKM
48	72	8	48-72-8MTCN	TC	NBR
48	72	8	48-72-8MVCN	VC	NBR
48	73	8	M 12407 H1L5	LPD	NBR
48	73	11	M 6727 H1L5	LA	NBR
48	73	13	M 6936 H1L5	LUP	NBR
48	73	16	M 17670 H1L5	LDS	NBR
48	74	10	48-74-10MSCN	SC	NBR
48	74	10	48-74-10MSCV	SC	FKM
48	74	10	48-74-10MTCN	TC	NBR
48	74	10	48-74-10MVCN	VC	NBR
48	75	10	48-75-10MSCN	SC	NBR



See Section 4 for seal type description. For FlexiSeal Listings see Page C-22.

03/03/06



Rotary Lip Seal Metric Sizes

C

Shaft Dia.	Bore Dia.	Seal Width	Parker Part Number	Seal Type	Material
48	75	10	48-75-10MSCV	SC	FKM
48	75	10	48-75-10MTCN	TC	NBR
48	75	10	48-75-10MVCN	VC	NBR
48	80	10	48-80-10MSCN	SC	NBR
48	80	10	48-80-10MSCV	SC	FKM
48	80	10	48-80-10MTCN	TC	NBR
48	80	10	48-80-10MVCN	VC	NBR
48	81	11	M 9302 H1L5	RPD	NBR
48	82	11	48-82-11MSCN	SC	NBR
48	82	11	48-82-11MSCV	SC	FKM
48	82	11	48-82-11MTCN	TC	NBR
48	82	11	48-82-11MVCN	VC	NBR
48	90	9	M 10189 H1L5	LPD	NBR
48	90	13	48-90-13MSCN	SC	NBR
48	90	13	48-90-13MSCV	SC	FKM
48	90	13	48-90-13MTCN	TC	NBR
48	90	13	48-90-13MVCN	VC	NBR
49	73	11	M 8874 H1L5	LUP	NBR
49	73	13	M 5828 H1L5	RUP	NBR
49	76	11	M 11535 H1L5	LPD	NBR
49	81	13	M 10949 H1L5	LPD	NBR
49	81	13	M 9396 H1L5	LPD	NBR
49	90	6	M 60010 H1L5	LDS	NBR
50	32	5	50-32-5MSCN	SC	NBR
50	32	5	50-32-5MSCV	SC	FKM
50	32	5	50-32-5MTCN	TC	NBR
50	32	5	50-32-5MVCN	VC	NBR
50	58	4	50-58-4MSCN	SC	NBR
50	58	4	50-58-4MSCV	SC	FKM
50	58	4	50-58-4MTCN	TC	NBR
50	58	4	50-58-4MVCN	VC	NBR
50	60	8	50-60-8MSCN	SC	NBR
50	60	8	50-60-8MSCV	SC	FKM
50	60	8	50-60-8MTCN	TC	NBR
50	60	8	50-60-8MVCN	VC	NBR
50	62	7	50-62-7MSCN	SC	NBR
50	62	7	50-62-7MSCV	SC	FKM
50	62	7	50-62-7MTCN	TC	NBR
50	62	7	50-62-7MVCN	VC	NBR
50	62	8	M 19895 H1L5	SS	NBR
50	63	8	50-63-8MSCN	SC	NBR
50	63	8	50-63-8MSCV	SC	FKM
50	63	8	50-63-8MTCN	TC	NBR
50	63	8	50-63-8MVCN	VC	NBR
50	65	8	M 15296 H1L5	LPD	NBR
50	65	8	50-65-8MSCN	SC	NBR
50	65	8	50-65-8MSCV	SC	FKM
50	65	8	M 0050 14043	SPLIT	NBR
50	65	8	50-65-8MTCN	TC	NBR
50	65	8	50-65-8MVCN	VC	NBR
50	65	10	50-65-10MSCN	SC	NBR
50	65	10	50-65-10MSCV	SC	FKM
50	65	10	50-65-10MTCN	TC	NBR
50	65	10	50-65-10MVCN	VC	NBR
50	68	8	50-68-8MSCN	SC	NBR
50	68	8	50-68-8MSCV	SC	FKM
50	68	8	50-68-8MTCN	TC	NBR
50	68	8	50-68-8MVCN	VC	NBR
50	70	8	50-70-8MSCN	SC	NBR
50	70	8	50-70-8MSCV	SC	FKM
50	70	8	50-70-8MTCN	TC	NBR
50	70	8	50-70-8MVCN	VC	NBR
50	70	10	M 15191 H1L2160	RPD	EPDM
50	70	10	M 15191 H1L5	RPD	NBR
50	72	8	50-72-8MSCN	SC	NBR
50	72	8	50-72-8MSCV	SC	FKM

Shaft Dia.	Bore Dia.	Seal Width	Parker Part Number	Seal Type	Material
50	72	8	50-72-8MTCN	TC	NBR
50	72	8	50-72-8MVCN	VC	NBR
50	72	10	M 10738 H1L5	LPD	NBR
50	73	13	M 8864 H1L5	LPD	NBR
50	75	8	50-75-8MSCN	SC	NBR
50	75	8	50-75-8MSCV	SC	FKM
50	75	8	50-75-8MTCN	TC	NBR
50	75	8	50-75-8MVCN	VC	NBR
50	80	8	50-80-8MSCN	SC	NBR
50	80	8	50-80-8MSCV	SC	FKM
50	80	8	50-80-8MTCN	TC	NBR
50	80	8	50-80-8MVCN	VC	NBR
50	80	13	M 10015 H1L5	LUP	NBR
50	81	12	M 3898 H1L5	LPD	NBR
50	89	13	M 8816 H1L5	LPD	NBR
50	90	10	50-90-10MSCN	SC	NBR
50	90	10	50-90-10MSCV	SC	FKM
50	90	10	50-90-10MTCN	TC	NBR
50	90	10	50-90-10MVCN	VC	NBR
50	90	13	M 12526 H1L5	LPD	NBR
50	110	8	M 12279 H1L5	LPD	NBR
51	65	4	M 11225 H1L7	SS	NBR
51	69	11	M 15558 H1L5	LUP	NBR
51	73	11	M 9653 H1L5	LPD	NBR
51	73	11	M 4162 H1L5	RUP	NBR
51	79	13	M 17604 H1L5	LDS	NBR
51	81	11	M 11240 H1L5	LPD	NBR
51	85	13	M 5144 H1L5	LUP	NBR
52	62	10	52-62-10MSCN	SC	NBR
52	62	10	52-62-10MSCV	SC	FKM
52	62	10	52-62-10MTCN	TC	NBR
52	62	10	52-62-10MVCN	VC	NBR
52	63	10	52-63-10MSCN	SC	NBR
52	63	10	52-63-10MSCV	SC	FKM
52	63	10	52-63-10MTCN	TC	NBR
52	63	10	52-63-10MVCN	VC	NBR
52	65	9	52-65-9MSCN	SC	NBR
52	65	9	52-65-9MSCV	SC	FKM
52	65	9	52-65-9MTCN	TC	NBR
52	65	9	52-65-9MVCN	VC	NBR
52	68	8	52-68-8MSCN	SC	NBR
52	68	8	52-68-8MSCV	SC	FKM
52	68	8	52-68-8MTCN	TC	NBR
52	68	8	52-68-8MVCN	VC	NBR
52	70	8	52-70-8MSCN	SC	NBR
52	70	8	52-70-8MSCV	SC	FKM
52	70	8	52-70-8MTCN	TC	NBR
52	70	8	52-70-8MVCN	VC	NBR
52	72	8	52-72-8MSCN	SC	NBR
52	72	8	52-72-8MSCV	SC	FKM
52	72	8	52-72-8MTCN	TC	NBR
52	72	8	52-72-8MVCN	VC	NBR
52	78	10	52-78-10MSCN	SC	NBR
52	78	10	52-78-10MSCV	SC	FKM
52	78	10	52-78-10MTCN	TC	NBR
52	78	10	52-78-10MVCN	VC	NBR
52	85	13	M 9933 H1L7	SS	NBR
54	68	10	54-68-10MSCN	SC	NBR
54	68	10	54-68-10MSCV	SC	FKM
54	68	10	54-68-10MTCN	TC	NBR
54	68	10	54-68-10MVCN	VC	NBR
54	72	10	54-72-10MSCN	SC	NBR
54	72	10	54-72-10MSCV	SC	FKM
54	72	10	54-72-10MTCN	TC	NBR
54	72	10	54-72-10MVCN	VC	NBR
54	72	11	M 4587 H1L5	LUP	NBR

See Section 4 for seal type description. For FlexiSeal Listings see Page C-22.

03/03/06



Rotary Lip Seal Metric Sizes

Shaft Dia.	Bore Dia.	Seal Width	Parker Part Number	Seal Type	Material
54	73	9	M 10259 H1L5	LUP	NBR
54	73	9	M 7131 H1L5	RUP	NBR
54	73	11	M 6113 H1L5	LPD	NBR
54	80	10	54-80-10MSCN	SC	NBR
54	80	10	54-80-10MSCV	SC	FKM
54	80	10	54-80-10MTCN	TC	NBR
54	80	10	54-80-10MVCN	VC	NBR
54	81	10	54-81-10MSCN	SC	NBR
54	81	10	54-81-10MSCV	SC	FKM
54	81	10	54-81-10MTCN	TC	NBR
54	81	10	54-81-10MVCN	VC	NBR
54	81	11	M 17178 H1L5	LDS	NBR
54	81	13	M 6956 H1L5	RPD	NBR
54	82	10	54-82-10MSCN	SC	NBR
54	82	10	54-82-10MSCV	SC	FKM
54	82	10	54-82-10MTCN	TC	NBR
54	82	10	54-82-10MVCN	VC	NBR
54	85	10	54-85-10MSCN	SC	NBR
54	85	10	54-85-10MSCV	SC	FKM
54	85	10	54-85-10MTCN	TC	NBR
54	85	10	54-85-10MVCN	VC	NBR
54	89	11	M 11981 H1L5	LPD	NBR
54	90	11	M 6941 H1L5	LA	NBR
55	62	7	55-62-7MSCN	SC	NBR
55	62	7	55-62-7MSCV	SC	FKM
55	62	7	55-62-7MTCN	TC	NBR
55	62	7	55-62-7MVCN	VC	NBR
55	65	8	55-65-8MSCN	SC	NBR
55	65	8	55-65-8MSCV	SC	FKM
55	65	8	55-65-8MTCN	TC	NBR
55	65	8	55-65-8MVCN	VC	NBR
55	68	8	55-68-8MSCN	SC	NBR
55	68	8	55-68-8MSCV	SC	FKM
55	68	8	55-68-8MTCN	TC	NBR
55	68	8	55-68-8MVCN	VC	NBR
55	70	8	M 14043 H1L2160	LPD	EPDM
55	70	8	M 14043 H1L5	LPD	NBR
55	70	8	55-70-8MSCN	SC	NBR
55	70	8	55-70-8MSCV	SC	FKM
55	70	8	55-70-8MTCN	TC	NBR
55	70	8	55-70-8MVCN	VC	NBR
55	72	8	55-72-8MSCN	SC	NBR
55	72	8	55-72-8MSCV	SC	FKM
55	72	8	55-72-8MTCN	TC	NBR
55	72	8	55-72-8MVCN	VC	NBR
55	72	9	M 5792 H1L5	LA	NBR
55	75	8	55-75-8MSCN	SC	NBR
55	75	8	55-75-8MSCV	SC	FKM
55	75	8	55-75-8MTCN	TC	NBR
55	75	8	55-75-8MVCN	VC	NBR
55	78	10	55-78-10MSCN	SC	NBR
55	78	10	55-78-10MSCV	SC	FKM
55	78	10	55-78-10MTCN	TC	NBR
55	78	10	55-78-10MVCN	VC	NBR
55	80	8	55-80-8MSCN	SC	NBR
55	80	8	55-80-8MSCV	SC	FKM
55	80	8	55-80-8MTCN	TC	NBR
55	80	8	55-80-8MVCN	VC	NBR
55	85	8	55-85-8MSCN	SC	NBR
55	85	8	55-85-8MSCV	SC	FKM
55	85	8	55-85-8MTCN	TC	NBR
55	85	8	55-85-8MVCN	VC	NBR
55	90	10	55-90-10MSCN	SC	NBR
55	90	10	55-90-10MSCV	SC	FKM
55	90	10	55-90-10MTCN	TC	NBR
55	90	10	55-90-10MVCN	VC	NBR

Shaft Dia.	Bore Dia.	Seal Width	Parker Part Number	Seal Type	Material
55	100	9	M 13284 H1L5	LDS	NBR
55	100	10	55-100-10MSCN	SC	NBR
55	100	10	55-100-10MSCV	SC	FKM
55	100	10	55-100-10MTCN	TC	NBR
55	100	10	55-100-10MVCN	VC	NBR
56	67	7	56-67-7MSCN	SC	NBR
56	67	7	56-67-7MSCV	SC	FKM
56	67	7	56-67-7MTCN	TC	NBR
56	67	7	56-67-7MVCN	VC	NBR
56	72	8	56-72-8MSCN	SC	NBR
56	72	8	56-72-8MSCV	SC	FKM
56	72	8	56-72-8MTCN	TC	NBR
56	72	8	56-72-8MVCN	VC	NBR
56	73	9	M 14970 H1L5	LPD	NBR
56	75	8	56-75-8MSCN	SC	NBR
56	75	8	56-75-8MSCV	SC	FKM
56	75	8	56-75-8MTCN	TC	NBR
56	75	8	56-75-8MVCN	VC	NBR
56	80	8	56-80-8MSCN	SC	NBR
56	80	8	56-80-8MSCV	SC	FKM
56	80	8	56-80-8MTCN	TC	NBR
56	80	8	56-80-8MVCN	VC	NBR
56	81	12	M 11055 H1L5	LUP	NBR
56	85	8	56-85-8MSCN	SC	NBR
56	85	8	56-85-8MSCV	SC	FKM
56	85	8	56-85-8MTCN	TC	NBR
56	85	8	56-85-8MVCN	VC	NBR
56	85	12	M 11696 H1L5	LPD	NBR
56	89	13	M 16469 H1L5	LDS	NBR
56	100	10	56-100-10MSCN	SC	NBR
56	100	10	56-100-10MSCV	SC	FKM
56	100	10	56-100-10MTCN	TC	NBR
56	100	10	56-100-10MVCN	VC	NBR
56	100	13	M 60014 H1L5	LDS	NBR
57	72	9	57-72-9MSCN	SC	NBR
57	72	9	57-72-9MSCV	SC	FKM
57	72	9	57-72-9MTCN	TC	NBR
57	72	9	57-72-9MVCN	VC	NBR
57	80	12	57-80-12MSCN	SC	NBR
57	80	12	57-80-12MSCV	SC	FKM
57	80	12	57-80-12MTCN	TC	NBR
57	80	12	57-80-12MVCN	VC	NBR
57	81	11	M 10513 H1L5	LUP	NBR
57	85	13	M 10982 H1L5	LPD	NBR
57	89	10	M 15889 H1L5	LUP	NBR
57	89	13	M 8991 H1L5	LPD	NBR
57	90	9	M 4049 H1L5	LUP	NBR
57	90	9	M 17514 H1L5	LUPW	NBR
57	805	10	57-805-10MSCN	SC	NBR
57	805	10	57-805-10MSCV	SC	FKM
57	805	10	57-805-10MTCN	TC	NBR
57	805	10	57-805-10MVCN	VC	NBR
58	72	8	58-72-8MSCN	SC	NBR
58	72	8	58-72-8MSCV	SC	FKM
58	72	8	58-72-8MTCN	TC	NBR
58	72	8	58-72-8MVCN	VC	NBR
58	80	8	58-80-8MSCN	SC	NBR
58	80	8	58-80-8MSCV	SC	FKM
58	80	8	58-80-8MTCN	TC	NBR
58	80	8	58-80-8MVCN	VC	NBR
60	74	10	60-74-10MSCN	SC	NBR
60	74	10	60-74-10MSCV	SC	FKM
60	74	10	60-74-10MTCN	TC	NBR
60	74	10	60-74-10MVCN	VC	NBR
60	75	8	60-75-8MSCN	SC	NBR
60	75	8	60-75-8MSCV	SC	FKM



See Section 4 for seal type description. For FlexiSeal Listings see Page C-22.

03/03/06



Rotary Lip Seal Metric Sizes

60 to 65

C

Shaft Dia.	Bore Dia.	Seal Width	Parker Part Number	Seal Type	Material
60	75	8	60-75-8MTCN	TC	NBR
60	75	8	60-75-8MVCN	VC	NBR
60	75	12	60-75-12MSCN	SC	NBR
60	75	12	60-75-12MSCV	SC	FKM
60	75	12	60-75-12MTCN	TC	NBR
60	75	12	60-75-12MVCN	VC	NBR
60	78	9	60-78-9MSCN	SC	NBR
60	78	9	60-78-9MSCV	SC	FKM
60	78	9	60-78-9MTCN	TC	NBR
60	78	9	60-78-9MVCN	VC	NBR
60	78	10	M 18038 H1L5	LUP	NBR
60	80	7	60-80-7MSCN	SC	NBR
60	80	7	60-80-7MSCV	SC	FKM
60	80	7	60-80-7MTCN	TC	NBR
60	80	7	60-80-7MVCN	VC	NBR
60	80	10	M 14643 H1L5	LPD	NBR
60	80	10	M 14643 H5L16	LPD	FKM
60	80	11	M 13857 H1L7	P	NBR
60	80	13	M 4690 H1L5	LPD	NBR
60	82	9	60-82-9MSCN	SC	NBR
60	82	9	60-82-9MSCV	SC	FKM
60	82	9	60-82-9MTCN	TC	NBR
60	82	9	60-82-9MVCN	VC	NBR
60	84	10	60-84-10MSCN	SC	NBR
60	84	10	60-84-10MSCV	SC	FKM
60	84	10	60-84-10MTCN	TC	NBR
60	84	10	60-84-10MVCN	VC	NBR
60	85	8	60-85-8MSCN	SC	NBR
60	85	8	60-85-8MSCV	SC	FKM
60	85	8	60-85-8MTCN	TC	NBR
60	85	8	60-85-8MVCN	VC	NBR
60	85	12	M 6071 H1L5	LUP	NBR
60	85	12	M 11453 H1L5	LUP	NBR
60	86	10	60-86-10MSCN	SC	NBR
60	86	10	60-86-10MSCV	SC	FKM
60	86	10	60-86-10MTCN	TC	NBR
60	86	10	60-86-10MVCN	VC	NBR
60	89	13	M 9319 H1L5	LPD	NBR
60	89	16	M 13315 H1L5	LDS	NBR
60	90	8	60-90-8MSCN	SC	NBR
60	90	8	60-90-8MSCV	SC	FKM
60	90	8	60-90-8MTCN	TC	NBR
60	90	8	60-90-8MVCN	VC	NBR
60	90	9	M 15457 H1L5	LPD	NBR
60	92	11	M 16536 H1L5	LUP	NBR
60	95	10	60-95-10MSCN	SC	NBR
60	95	10	60-95-10MSCV	SC	FKM
60	95	10	60-95-10MTCN	TC	NBR
60	95	10	60-95-10MVCN	VC	NBR
60	100	10	60-100-10MSCN	SC	NBR
60	100	10	60-100-10MSCV	SC	FKM
60	100	10	60-100-10MTCN	TC	NBR
60	100	10	60-100-10MVCN	VC	NBR
60	110	13	M 15440 H1L7	SS	NBR
60	130	9	M 13283 H1L5	LDS	NBR
61	73	8	M 5638 H1L7	SS	NBR
61	80	10	M 10385 H1L5	LPD	NBR
61	85	13	M 9144 H1L5	LPD	NBR
61	85	13	M 19069 H1L5	RPD	NBR
62	80	10	62-80-10MSCN	SC	NBR
62	80	10	62-80-10MSCV	SC	FKM
62	80	10	62-80-10MTCN	TC	NBR
62	80	10	62-80-10MVCN	VC	NBR
62	80	12	62-80-12MSCN	SC	NBR
62	80	12	62-80-12MSCV	SC	FKM
62	80	12	62-80-12MTCN	TC	NBR

Shaft Dia.	Bore Dia.	Seal Width	Parker Part Number	Seal Type	Material
62	80	12	62-80-12MVCN	VC	NBR
62	85	10	62-85-10MSCN	SC	NBR
62	85	10	62-85-10MSCV	SC	FKM
62	85	10	62-85-10MTCN	TC	NBR
62	85	10	62-85-10MVCN	VC	NBR
62	89	13	M 11143 H1L5	LUP	NBR
62	90	10	62-90-10MSCN	SC	NBR
62	90	10	62-90-10MSCV	SC	FKM
62	90	10	62-90-10MTCN	TC	NBR
62	90	10	62-90-10MVCN	VC	NBR
62	90	11	M 9374 HL15	LPD	NBR
62	90	13	M 6432 HL15	LA	NBR
62	92	13	M 10014 H1L5	LUP	NBR
62	110	13	62-110-13MSCN	SC	NBR
62	110	13	62-110-13MSCV	SC	FKM
62	110	13	62-110-13MTCN	TC	NBR
62	110	13	62-110-13MVCN	VC	NBR
63	80	9	63-80-9MSCN	SC	NBR
63	80	9	63-80-9MSCV	SC	FKM
63	80	9	63-80-9MTCN	TC	NBR
63	80	9	63-80-9MVCN	VC	NBR
63	88	12	63-88-12MSCN	SC	NBR
63	88	12	63-88-12MSCV	SC	FKM
63	88	12	63-88-12MTCN	TC	NBR
63	88	12	63-88-12MVCN	VC	NBR
63	89	13	M 14620 H1L5	LDS	NBR
63	89	13	M 11814 HL15	LPDW	NBR
63	90	10	63-90-10MSCN	SC	NBR
63	90	10	63-90-10MSCV	SC	FKM
63	90	10	63-90-10MTCN	TC	NBR
63	90	10	63-90-10MVCN	VC	NBR
63	90	15	M 19510 H1L5	RUP	NBR
64	81	10	M 10184 H1L5	LUP	NBR
64	85	6	M 10345 H1L5	LPD	NBR
64	89	13	M 16203 H1L5	H	NBR
64	89	13	M 7030 H1L5	LA	NBR
64	89	13	M 10121 H1L5	LUP	NBR
64	89	19	M 12036 H1L7	P	NBR
64	90	9	M 11167 H1L5	LPD	NBR
64	90	13	M 8865 H1L5	LPD	NBR
64	90	13	M 8865 H5L89	LPD	FKM
64	90	13	M 10953 H1L5	LUP	NBR
64	92	3	M 9863 H1L5	LPD	NBR
64	100	14	M 14048 H1L5	LPDW	NBR
64	110	14	M 14053 H1L5	LPDW	NBR
64	120	12	M 14052 H1L5	LPDW	NBR
65	77	9	M 16245 H1L7	P	NBR
65	80	8	65-80-8MSCN	SC	NBR
65	80	8	65-80-8MSCV	SC	FKM
65	80	8	65-80-8MTCN	TC	NBR
65	80	8	65-80-8MVCN	VC	NBR
65	85	10	M 17760 H1L20	LUP	XNBR
65	85	10	M 17760 H1L5	LUP	NBR
65	85	10	65-85-10MSCN	SC	NBR
65	85	10	65-85-10MSCV	SC	FKM
65	85	10	65-85-10MTCN	TC	NBR
65	85	10	65-85-10MVCN	VC	NBR
65	85	10	65-85-10MVCN	VC	NBR
65	88	12	65-88-12MSCN	SC	NBR
65	88	12	65-88-12MSCV	SC	FKM
65	88	12	65-88-12MTCN	TC	NBR
65	88	12	65-88-12MVCN	VC	NBR
65	89	9	M 9188 H1L5	LPD	NBR

See Section 4 for seal type description. For FlexiSeal Listings see Page C-22.

03/03/06



Rotary Lip Seal Metric Sizes

Shaft Dia.	Bore Dia.	Seal Width	Parker Part Number	Seal Type	Material
65	89	11	M 10208 H1L5	LUP	NBR
65	90	9	M 14610 H1L5	LPD	NBR
65	90	10	M 15308 H1L5	RPD	NBR
65	90	10	65-90-10MSCV	SC	FKM
65	90	10	65-90-10MSCN	SC	NBR
65	90	10	65-90-10MSCV	SC	FKM
65	90	10	65-90-10MTCN	TC	NBR
65	90	10	65-90-10MVCN	VC	NBR
65	92	13	M 6869 H1L5	LUP	NBR
65	95	10	65-95-10MSCN	SC	NBR
65	95	10	65-95-10MSCV	SC	FKM
65	95	10	65-95-10MTCN	TC	NBR
65	95	10	65-95-10MVCN	VC	NBR
65	100	9	M 11801 H1L5	LDS	NBR
65	100	9	M 11801 H5L89	LDS	FKM
65	100	10	65-100-10MSCN	SC	NBR
65	100	10	65-100-10MSCV	SC	FKM
65	100	10	65-100-10MTCN	TC	NBR
65	100	10	65-100-10MVCN	VC	NBR
65	110	13	65-110-13MSCN	SC	NBR
65	110	13	65-110-13MSCV	SC	FKM
65	110	13	65-110-13MTCN	TC	NBR
65	110	13	65-110-13MVCN	VC	NBR
65	115	12	65-115-12MSCN	SC	NBR
65	115	12	65-115-12MSCV	SC	FKM
65	115	12	65-115-12MTCN	TC	NBR
65	115	12	65-115-12MVCN	VC	NBR
65	140	13	M 13281 H1L5	LDS	NBR
67	85	9	M 9452 H1L5	LPD	NBR
67	89	10	M 11017 H1L5	LUP	NBR
67	89	11	M 9055 H1L5	RUP	NBR
67	89	13	M 13858 H1L5	LDS	NBR
67	89	13	M 10910 H1L5	LPD	NBR
67	92	11	M 10050 H1L5	LUP	NBR
67	92	11	M 3681 H1L5	RPD	NBR
67	92	13	M 12141 H1L5	LPDW	NBR
67	92	13	M 7110 H1L5	LUP	NBR
68	85	10	68-85-10MSCN	SC	NBR
68	85	10	68-85-10MSCV	SC	FKM
68	85	10	68-85-10MTCN	TC	NBR
68	85	10	68-85-10MVCN	VC	NBR
68	90	10	68-90-10MSCN	SC	NBR
68	90	10	68-90-10MSCV	SC	FKM
68	90	10	68-90-10MTCN	TC	NBR
68	90	10	68-90-10MVCN	VC	NBR
68	100	12	68-100-12MSCN	SC	NBR
68	100	12	68-100-12MSCV	SC	FKM
68	100	12	68-100-12MTCN	TC	NBR
68	100	12	68-100-12MVCN	VC	NBR
70	80	10	70-80-10MSCN	SC	NBR
70	80	10	70-80-10MSCV	SC	FKM
70	80	10	70-80-10MTCN	TC	NBR
70	80	10	70-80-10MVCN	VC	NBR
70	85	8	M 7362 H1L5	RPD	NBR
70	85	8	70-85-8MSCN	SC	NBR
70	85	8	70-85-8MSCV	SC	FKM
70	85	8	70-85-8MTCN	TC	NBR
70	85	8	70-85-8MVCN	VC	NBR
70	87	10	70-87-10MSCN	SC	NBR
70	87	10	70-87-10MSCV	SC	FKM
70	87	10	70-87-10MTCN	TC	NBR
70	87	10	70-87-10MVCN	VC	NBR
70	88	12	70-88-12MSCN	SC	NBR
70	88	12	70-88-12MSCV	SC	FKM
70	88	12	70-88-12MTCN	TC	NBR
70	88	12	70-88-12MVCN	VC	NBR

Shaft Dia.	Bore Dia.	Seal Width	Parker Part Number	Seal Type	Material
70	89	9	M 14042 H1L5	LPD	NBR
70	89	10	M 11985 H1L7	P	NBR
70	89	11	M 10364 H1L5	LPD	NBR
70	89	13	M 14781 H1L5	LDS	NBR
70	89	13	M 11894 H1L5	LPD	NBR
70	89	14	M 10635 H1L5	LDS	NBR
70	90	10	M 15297 H1L5	LPD	NBR
70	90	10	M 15297 H5L16	LPD	FKM
70	90	10	M 15318 H1L5	RPD	NBR
70	90	10	M 15318 H5L16	RPD	FKM
70	90	10	M 19577 H1L5	RUP	NBR
70	90	10	70-90-10MSCN	SC	NBR
70	90	10	70-90-10MSCV	SC	FKM
70	90	10	70-90-10MTCN	TC	NBR
70	90	10	70-90-10MVCN	VC	NBR
70	90	11	M 8470 H1L5	LUP	NBR
70	90	11	M 8470 H5L16	LUP	FKM
70	90	11	M 14097 H1L7	P	NBR
70	92	10	70-92-10MSCN	SC	NBR
70	92	10	70-92-10MSCV	SC	FKM
70	92	10	70-92-10MTCN	TC	NBR
70	92	10	70-92-10MVCN	VC	NBR
70	92	11	M 12494 H1L5	LPD	NBR
70	95	10	70-95-10MSCN	SC	NBR
70	95	10	70-95-10MSCV	SC	FKM
70	95	10	70-95-10MTCN	TC	NBR
70	95	10	70-95-10MVCN	VC	NBR
70	100	10	70-100-10MSCN	SC	NBR
70	100	10	70-100-10MSCV	SC	FKM
70	100	10	70-100-10MTCN	TC	NBR
70	100	10	70-100-10MVCN	VC	NBR
70	100	12	M 14694 H1L5	LPD	NBR
70	100	13	70-100-13MSCN	SC	NBR
70	100	13	70-100-13MSCV	SC	FKM
70	100	13	70-100-13MTCN	TC	NBR
70	100	13	70-100-13MVCN	VC	NBR
70	110	8	70-110-8MSCN	SC	NBR
70	110	8	70-110-8MSCV	SC	FKM
70	110	8	70-110-8MTCN	TC	NBR
70	110	8	70-110-8MVCN	VC	NBR
70	112	13	70-112-13MSCN	SC	NBR
70	112	13	70-112-13MSCV	SC	FKM
70	112	13	70-112-13MTCN	TC	NBR
70	112	13	70-112-13MVCN	VC	NBR
70	127	13	M 60020 H1L5	LDS	NBR
72	91	9.5	M 0072 8472	SPLIT	NBR
72	95	10	M 15325 H5L89	RPD	FKM
72	96	9	72-96-9MSCN	SC	NBR
72	96	9	72-96-9MSCV	SC	FKM
72	96	9	72-96-9MTCN	TC	NBR
72	96	9	72-96-9MVCN	VC	NBR
72	100	10	72-100-10MSCN	SC	NBR
72	100	10	72-100-10MSCV	SC	FKM
72	100	10	72-100-10MTCN	TC	NBR
72	100	10	72-100-10MVCN	VC	NBR
72	100	12	M 9386 H1L5	RPD	NBR
72	100	13	M 12553 H1L5	LPD	NBR
72	105	13	72-105-13MSCN	SC	NBR
72	105	13	72-105-13MSCV	SC	FKM
72	105	13	72-105-13MTCN	TC	NBR
72	105	13	72-105-13MVCN	VC	NBR
73	89	8	M 3631 H1L5	LPD	NBR
73	89	9	M 10209 H1L5	LPD	NBR
73	92	9	M 10065 H1L5	LUP	NBR
73	92	11	M 10165 H1L5	LPD	NBR
73	110	13	M 5956 H1L5	LA	NBR



See Section 4 for seal type description. For FlexiSeal Listings see Page C-22.

03/03/06



Rotary Lip Seal Metric Sizes

Shaft Dia.	Bore Dia.	Seal Width	Parker Part Number	Seal Type	Material
73	120	13	M 3992 H1L5	LPD	NBR
75	90	10	75-90-10MSCN	SC	NBR
75	90	10	75-90-10MSCV	SC	FKM
75	90	10	75-90-10MTCN	TC	NBR
75	90	10	75-90-10MVCN	VC	NBR
75	92	9	M 9672 H1L5	LPD	NBR
75	92	9	M 5684 H1L5	RPD	NBR
75	93	9.5	M 0075 8472	SPLIT	NBR
75	95	10	M 20650 H5L16PT	LUP	F/P
75	95	10	M 30171 H1L5	LUP	NBR
75	95	10	75-95-10MSCN	SC	NBR
75	95	10	75-95-10MSCV	SC	FKM
75	95	10	75-95-10MTCN	TC	NBR
75	95	10	75-95-10MVCN	VC	NBR
75	100	7	M 0075 15329	SPLIT	NBR
75	100	10	M 15089 H1L5	LPD	NBR
75	100	10	75-100-10MSCN	SC	NBR
75	100	10	75-100-10MSCV	SC	FKM
75	100	10	75-100-10MTCN	TC	NBR
75	100	10	75-100-10MVCN	VC	NBR
75	100	12	75-100-12MSCN	SC	NBR
75	100	12	75-100-12MSCV	SC	FKM
75	100	12	75-100-12MTCN	TC	NBR
75	100	12	75-100-12MVCN	VC	NBR
75	100	13	M 4183 H1L5	LPD	NBR
75	100	13	M 15174 H1L5	LPD	NBR
75	102	13	M 0075 11083 V	SPLIT	FKM
75	105	12	75-105-12MSCN	SC	NBR
75	105	12	75-105-12MSCV	SC	FKM
75	105	12	75-105-12MTCN	TC	NBR
75	105	12	75-105-12MVCN	VC	NBR
75	106	13	M 19484 H1L5	LDS	NBR
75	106	13	M 19484 H5L89	LDS	FKM
75	110	13	75-110-13MSCN	SC	NBR
75	110	13	75-110-13MSCV	SC	FKM
75	110	13	75-110-13MTCN	TC	NBR
75	110	13	75-110-13MVCN	VC	NBR
75	115	9	M 11716 H1L5	LDS	NBR
75	115	9	M 11292 H1L5	LPD	NBR
75	115	10	75-115-10MSCN	SC	NBR
75	115	10	75-115-10MSCV	SC	FKM
75	115	10	75-115-10MTCN	TC	NBR
75	115	10	75-115-10MVCN	VC	NBR
75	160	9	M 15479 H1L5	LPD	NBR
76	100	9	M 14511 H1L5	LUP	NBR
76	102	13	76-102-13MSCN	SC	NBR
76	102	13	76-102-13MSCV	SC	FKM
76	102	13	76-102-13MTCN	TC	NBR
76	102	13	76-102-13MVCN	VC	NBR
76	105	13	M 9368 H1L5	LPD	NBR
76	108	13	M 11830 H1L5	LUP	NBR
76	108	13	M 4314 H1L5	RUP	NBR
76	127	13	M 9004 H1L5	LPD	NBR
76	130	16	M 14055 H1L5	LUPW	NBR
76	140	16	M 14056 H1L5	LUPW	NBR
77	108	16	M 6073 H1L5	LUP	NBR
78	97	9	M 8472 H1L5	RUP	NBR
78	100	10	78-100-10MSCN	SC	NBR
78	100	10	78-100-10MSCV	SC	FKM
78	100	10	78-100-10MTCN	TC	NBR
78	100	10	78-100-10MVCN	VC	NBR
78	108	13	M 10960 H1L5	LPD	NBR
79	108	9	M 11606 H1L7	SS	NBR
79	125	16	M 5766 H1L5	LPD	NBR
79	125	16	M 5766 H5L16	LPD	FKM
80	95	8	80-95-8MSCN	SC	NBR

Shaft Dia.	Bore Dia.	Seal Width	Parker Part Number	Seal Type	Material
80	95	8	80-95-8MSCV	SC	FKM
80	95	8	80-95-8MTCN	TC	NBR
80	95	8	80-95-8MVCN	VC	NBR
80	100	8	80-100-8MSCN	SC	NBR
80	100	8	80-100-8MSCV	SC	FKM
80	100	8	80-100-8MTCN	TC	NBR
80	100	8	80-100-8MVCN	VC	NBR
80	100	10	M 14644 H1L5	LPD	NBR
80	100	13	M 16432 H1L5	LUP	NBR
80	105	10	80-105-10MSCN	SC	NBR
80	105	10	80-105-10MSCV	SC	FKM
80	105	10	80-105-10MTCN	TC	NBR
80	105	10	80-105-10MVCN	VC	NBR
80	108	12	M 4801 H1L5	DS	NBR
80	108	13	M 3706 H1L5	RPD	NBR
80	108	16	M 9092 H1L5	LPD	NBR
80	110	10	80-110-10MSCN	SC	NBR
80	110	10	80-110-10MSCV	SC	FKM
80	110	10	80-110-10MTCN	TC	NBR
80	110	10	80-110-10MVCN	VC	NBR
80	115	13	80-115-13MSCN	SC	NBR
80	115	13	80-115-13MSCV	SC	FKM
80	115	13	80-115-13MTCN	TC	NBR
80	115	13	80-115-13MVCN	VC	NBR
80	120	12	80-120-12MTCN	TC	HNBR
80	124	29	M 19813 H1L5	OLSS	NBR
80	127	12	M 9523 H1L5	LPD	NBR
81	108	13	M 7227 H1L5	LPD	NBR
81	108	13	M 7036 H1L5	RUP	NBR
81	127	13	M 9542 H1L5	LPD	NBR
82	105	12	82-105-12MSCN	SC	NBR
82	105	12	82-105-12MSCV	SC	FKM
82	105	12	82-105-12MTCN	TC	NBR
82	105	12	82-105-12MVCN	VC	NBR
83	108	11	M 7190 H1L5	LUP	NBR
83	108	13	M 11764 H1L5	H	NBR
83	108	13	M 8918 H1L5	RUP	NBR
83	108	16	M 11497 H1L5	LPD	NBR
83	127	12	M 8945 H1L5	LUP	NBR
83	1008	16	M 13241 H1L5	LDS	NBR
84	108	16	M 12253 H1L5	LPD	NBR
84	110	16	84-110-16MSCN	SC	NBR
84	110	16	84-110-16MSCV	SC	FKM
84	110	16	84-110-16MTCN	TC	NBR
84	110	16	84-110-16MVCN	VC	NBR
84	127	13	M 14237 H1L5	LPD	NBR
85	105	12	85-105-12MSCN	SC	NBR
85	105	12	85-105-12MSCV	SC	FKM
85	105	12	85-105-12MTCN	TC	NBR
85	105	12	85-105-12MVCN	VC	NBR
85	105	13	M 16431 H1L5	LUP	NBR
85	110	10	85-110-10MSCN	SC	NBR
85	110	10	85-110-10MSCV	SC	FKM
85	110	10	85-110-10MTCN	TC	NBR
85	110	10	85-110-10MVCN	VC	NBR
85	110	12	M 15321 H1L5	RPD	NBR
85	120	12	M 16094 H1L5	RUP	NBR
85	120	12	85-120-12MSCN	SC	NBR
85	120	12	85-120-12MSCV	SC	FKM
85	120	12	85-120-12MTCN	TC	NBR
85	120	12	85-120-12MVCN	VC	NBR
85	125	12	85-125-12MSCN	SC	NBR
85	125	12	85-125-12MSCV	SC	FKM
85	125	12	85-125-12MTCN	TC	NBR
85	125	12	85-125-12MVCN	VC	NBR
85	130	12	85-130-12MSCN	SC	NBR

See Section 4 for seal type description. For FlexiSeal Listings see Page C-22.

03/03/06



Rotary Lip Seal Metric Sizes

Shaft Dia.	Bore Dia.	Seal Width	Parker Part Number	Seal Type	Material
85	130	12	85-130-12MSCV	SC	FKM
85	130	12	85-130-12MTCN	TC	NBR
85	130	12	85-130-12MVCN	VC	NBR
85	130	13	M 11785 H1L5	LDS	NBR
85	140	12	85-140-12MSCN	SC	NBR
85	140	12	85-140-12MSCV	SC	FKM
85	140	12	85-140-12MTCN	TC	NBR
85	140	12	85-140-12MVCN	VC	NBR
86	108	13	M 16473 H1L5	LDS	NBR
86	108	16	M 16541 H1L5	LUP	NBR
86	127	12	M 4463 H1L5	LUP	NBR
86	130	11	M 15383 H1L5	LPD	NBR
87	127	13	M 9512 H1L5	LUP	NBR
88	110	12	M 17279 H1L5	LUP	NBR
89	108	11	M 9728 H1L5	RUP	NBR
89	120	9	M 17402 H1L5	LDS	NBR
89	127	12	M 9410 H1L5	LUP	NBR
89	127	14	M 9457 H1L5	LPDW	NBR
89	127	14	M 15810 H5L16	LUP	FKM
89	127	15	M 17779 H1L5	LDS	NBR
89	150	16	M 14054 H1L5	LPDW	NBR
90	105	10	90-105-10MSCN	SC	NBR
90	105	10	90-105-10MSCV	SC	FKM
90	105	10	90-105-10MTCN	TC	NBR
90	105	10	90-105-10MVCN	VC	NBR
90	110	8	90-110-8MSCN	SC	NBR
90	110	8	90-110-8MSCV	SC	FKM
90	110	8	90-110-8MTCN	TC	NBR
90	110	8	90-110-8MVCN	VC	NBR
90	110	12	M 15396 H1L5	RPD	NBR
90	110	12	M 15396 H5L16	RPD	FKM
90	110	13	M 19819 H1L5	LUP	NBR
90	115	12	90-115-12MSCN	SC	NBR
90	115	12	90-115-12MSCV	SC	FKM
90	115	12	90-115-12MTCN	TC	NBR
90	115	12	90-115-12MVCN	VC	NBR
90	118	12	90-118-12MSCN	SC	NBR
90	118	12	90-118-12MSCV	SC	FKM
90	118	12	90-118-12MTCN	TC	NBR
90	118	12	90-118-12MVCN	VC	NBR
90	120	12	M 13160 H1L5	LPD	NBR
90	120	12	90-120-12MSCN	SC	NBR
90	120	12	90-120-12MSCV	SC	FKM
90	120	12	90-120-12MTCN	TC	NBR
90	120	12	90-120-12MVCN	VC	NBR
90	125	13	90-125-13MSCN	SC	NBR
90	125	13	90-125-13MSCV	SC	FKM
90	125	13	90-125-13MTCN	TC	NBR
90	125	13	90-125-13MVCN	VC	NBR
92	127	12	M 9587 H1L5	LPD	NBR
93	120	4	M 12182 H1L7	SS	NBR
94	116	11	M 4086 H1L5	LUP	NBR
95	110	10	M 19493 H1L5	LUP	NBR
95	110	10	M 19493 H5L89	LUP	FKM
95	115	10	M 19492 H1L5	LUP	NBR
95	115	12	M 15120 H1L5	LPD	NBR
95	115	12	95-115-12MSCN	SC	NBR
95	115	12	95-115-12MSCV	SC	FKM
95	115	12	95-115-12MTCN	TC	NBR
95	115	12	95-115-12MVCN	VC	NBR
95	120	11	M 0095 9788	SPLIT	NBR
95	120	12	M 15320 H1L5	RPD	NBR
95	120	12	95-120-12MSCN	SC	NBR
95	120	12	95-120-12MSCV	SC	FKM
95	120	12	95-120-12MTCN	TC	NBR
95	120	12	95-120-12MVCN	VC	NBR

Shaft Dia.	Bore Dia.	Seal Width	Parker Part Number	Seal Type	Material
95	125	12	M 30020 H1L5	LUP	NBR
95	125	12	95-125-12MSCN	SC	NBR
95	125	12	95-125-12MSCV	SC	FKM
95	125	12	95-125-12MTCN	TC	NBR
95	125	12	95-125-12MVCN	VC	NBR
95	127	12	M 18024 H1L5	LPD	NBR
95	127	12	M 10057 H1L5	LUP	NBR
95	127	13	M 10859 H1L5	LPD	NBR
95	130	12	95-130-12MSCN	SC	NBR
95	130	12	95-130-12MSCV	SC	FKM
95	130	12	95-130-12MTCN	TC	NBR
95	130	12	95-130-12MVCN	VC	NBR
95	135	13	95-135-13MSCN	SC	NBR
95	135	13	95-135-13MSCV	SC	FKM
95	135	13	95-135-13MTCN	TC	NBR
95	135	13	95-135-13MVCN	VC	NBR
95	145	13	95-145-13MSCN	SC	NBR
95	145	13	95-145-13MSCV	SC	FKM
95	145	13	95-145-13MTCN	TC	NBR
95	145	13	95-145-13MVCN	VC	NBR
97	127	12	M 7014 H1L5	LA	NBR
98	127	12	M 6218 H1L5	LUP	NBR
100	112	9	M 15518 H1L7	P	NBR
100	120	12	100-120-12MSCN	SC	NBR
100	120	12	100-120-12MSCV	SC	FKM
100	120	12	100-120-12MTCN	TC	NBR
100	120	12	100-120-12MVCN	VC	NBR
100	125	12	100-125-12MSCN	SC	NBR
100	125	12	100-125-12MSCV	SC	FKM
100	125	12	100-125-12MTCN	TC	NBR
100	125	12	100-125-12MVCN	VC	NBR
100	127	9	M 5910 H1L5	LPD	NBR
100	127	9	M 5910 H1L5	LPD	NBR
100	127	12	M 9402 H1L5	LUP	NBR
100	127	12	M 9864 H1L5	RUP	NBR
100	127	13	M 11239 H1L5	LPDW	NBR
100	127	13	M 9510 H1L5	LUP	NBR
100	127	13	M 19230 H1L5	LUP	NBR
100	130	13	100-130-13MSCN	SC	NBR
100	130	13	100-130-13MSCV	SC	FKM
100	130	13	100-130-13MTCN	TC	NBR
100	130	13	100-130-13MVCN	VC	NBR
100	132	12	M 0100 30182	SPLIT	NBR
100	140	13	100-140-13MSCN	SC	NBR
100	140	13	100-140-13MSCV	SC	FKM
100	140	13	100-140-13MTCN	TC	NBR
100	140	13	100-140-13MVCN	VC	NBR
100	150	13	M 11791 H1L5	LDS	NBR
100	150	13	M 60009 H1L5	LDS	NBR
101	141	13	M 0101 15323	SPLIT	NBR
102	127	11	M 9788 H1L5	RPD	NBR
102	127	12	M 6146 H1L5	LUP	NBR
102	127	12	M 9866 H1L5	LUP	NBR
102	127	13	M 11336 H1L7	H	NBR
102	127	13	M 15141 H1L5	LDS	NBR
102	127	13	M 7199 H1L5	LUP	NBR
102	127	13	M 9342 H1L7	SS	NBR
102	146	14	M 9151 H1L5	LPD	NBR
102	160	14	M 14259 H1L5	LPDW	NBR
105	120	12	M 15123 H1L7	P	NBR
105	127	11	M 17228 H1L5	LUP	NBR
105	127	19	M 12686 H1L7	P	NBR
105	130	12	M 19945 H1L5 PT	LUP	N/P
105	130	15	M 20707 H5L89	LUP	FKM
105	145	13	M 0105 15323	SPLIT	NBR
105	146	14	M 11120 H1L5	LPD	NBR



See Section 4 for seal type description. For FlexiSeal Listings see Page C-22.

03/03/06



Rotary Lip Seal Metric Sizes

Shaft Dia.	Bore Dia.	Seal Width	Parker Part Number	Seal Type	Material
106	127	12	M 6263 H1L5	LA	NBR
107	162	16	M 11517 H1L5	LPD	NBR
108	127	11	M 10490 H1L5	LUP	NBR
108	127	14	M 10042 H1L5	RPD	NBR
108	146	14	M 8809 H1L5	LPD	NBR
108	150	14	M 11758 H1L5	LUP	NBR
110	130	13	M 16433 H5L16	LUP	FKM
110	135	12	M 15716 H1L7	P	NBR
110	136.98	12.7	M 0110 11084	SPLIT	NBR
110	140	13	M 13153 H1L5	RPD	NBR
110	146	16	M 7192 H1L5	LPD	NBR
110	150	13	M 15323 H1L5	RUP	NBR
110	150	16	M 30028 H1L5	LUP	NBR
110	180	13	M 13282 H1L5	LDS	NBR
111	146	14	M 10470 H1L5	LPD	NBR
113	146	13	M 8825 H1L5	LUP	NBR
114	146	13	M 5295 H1L5	RPD	NBR
114	146	14	M 11709 H1L5	LUP	NBR
114	162	14	M 5991 H1L5	LUP	NBR
115	140	12	M 16926 H1L5	LPD	NBR
115	146	13	M 7191 H1L5	LPD	NBR
115	146	13	M 9425 H1L7	SS	NBR
115	146	16	M 7145 H1L5	LPD	NBR
116	146	14	M 15070 H1L5	LPDW	NBR
116	146	14	M 16816 H1L5	LUP	NBR
117	146	14	M 5594 H1L5	LUP	NBR
119	146	13	M 12861 H1L5	LPD	NBR
119	146	13	M 3696 H1L5	RPD	NBR
119	146	14	M 8900 H1L5	LPD	NBR
120	135	12	M 15225 H5L16	P	FKM
120	139	9.5	M 0120 3768	SPLIT	NBR
120	140	13	M 15175 H1L5	RUP	NBR
120	140	13	M 15175 H5L16	RUP	FKM
120	150	15	M 15324 H1L5	RPD	NBR
120	150	16	M 19754 H1L5	LUP	NBR
120	160	12	M 15209 H1L5	LUP	NBR
120	160	15	M 0120 15312	SPLIT	NBR
121	146	13	M 9820 H1L5	LUP	NBR
121	146	13	M 16222 H1L5	LUPW	NBR
121	146	14	M 9963 H1L5	LPD	NBR
121	165	16	M 8812 H1L5	LUP	NBR
121	165	20	M 12766 H1L5	LPDW	NBR
124	146	9	M 17424 H1L5	RUP	NBR
124	165	13	M 4924 H1L5	RPD	NBR
125	150	12	M 19662 H1L5	LUP	NBR
125	150	12	M 19662 H1L5 TM	LUP	NBR
125	150	12	M 16992 H1L5	LUPW	NBR
125	150	12.7	M 0125 12188	SPLIT	NBR
125	150	15	M 30075 H1L5	LUP	NBR
125	158	14.3	M 0125 6260	SPLIT	NBR
125	160	15	M 15310 H1L5	RPD	NBR
127	146	9	M 17164 H1L5	LUP	NBR
127	146	11	M 9333 H1L5	LUP	NBR
127	148	9	M 7127 H1L7	SS	NBR
127	165	14	M 9044 H1L5	LUP	NBR
127	165	16	M 6671 H1L5	LUP	NBR
129	162	14	M 5148 H1L5	LPD	NBR
129	162	14	M 6260 H1L5	RPD	NBR
130	150	9.5	M 0130 3768	SPLIT	NBR
130	160	12	M 19814 H1L5	LUP	NBR
130	160	12	M 19814 H1L5 PT	LUP	N/P
130	160	12	M 19814 H5L89	LUP	FKM
130	160	12	M 30156 H5L16	RUP	FKM
130	160	12	M 0130 9957 V	SPLIT	FKM
130	160	12.7	M 0130 12116	SPLIT	NBR
130	160	15	M 15033 H1L5	LPD	NBR

Shaft Dia.	Bore Dia.	Seal Width	Parker Part Number	Seal Type	Material
130	162	14	M 4212 H1L5	RPD	NBR
130	162	15.8	M 0130 3708	SPLIT	NBR
130	162	16	M 10151 H1L5	LUP	NBR
130	162	16	M 6585 H1L5	RPD	NBR
130	170	15	M 15312 H1L5	RUP	NBR
132	160	12	M 18746 H1L5	RUP	NBR
132	165	13	M 7336 H1L5	LPD	NBR
133	163	12	M 9957 H1L5	RPD	NBR
133	163	12	M 9957 H5L16	RPD	FKM
133	165	16	M 7112 H1L5	LUP	NBR
133	165	16	M 3708 H1L5	RUP	NBR
133	184	16	M 18501 HL15	LUP	NBR
134	162	16	M 4484 H1L5	RPD	NBR
134	162	16	M 4484 H1L5 PTF	RPD	N/P
134	165	14	M 14634 H1L5	LPD	NBR
134	178	13	M 14133 H1L5	LUP	NBR
135	170	12	NTC81155	TC	NBR
135	170	15	M 30192 H1L5	LUP	NBR
136	205	13	M 13164 H1L5	LPD	NBR
137	162	13	M 12188 H1L5	RPD	NBR
137	165	13	M 10598 H1L5	LUP	NBR
137	165	13	M 6530 H1L5	RPD	NBR
138	165	9	M 12260 H1L7	SS	NBR
138	170	12.7	M 0138 10231	SPLIT	NBR
140	159	9.5	M 0140 3768	SPLIT	NBR
140	165	13	M 5926 H1L5	LUP	NBR
140	170	13	M 15201 H1L7	SS	NBR
140	170	16	M 19755 H1L5	LDS	NBR
140	170	16	M 19755 H1L70	LDS	NBR
140	170	16	M 19755 H5L89	LDS	FKM
140	178	16	M 12446 H1L5	LPD	NBR
140	178	19	M 13052 H1L5	LDS	NBR
140	180	15	M 15313 H1L5	RPD	NBR
140	180	16	M 30029 H1L5	LUP	NBR
141	165	16	M 17400 H1L5	SDS	NBR
143	162	9	M 3768 H1L5	RPD	NBR
143	181	19	M 10786 H1L5	RPD	NBR
146	178	13	M 14915 H1L5	LPD	NBR
146	178	14	M 10303 H1L5	LUP	NBR
146	178	15	M 9165 H1L5	LUP	NBR
146	178	16	M 4286 H1L5	RPD	NBR
146	184	16	M 7007 HL15	LA	NBR
150	175	12.7	M 0150 12737	SPLIT	NBR
150	178	14.3	RM 0150 4337	SPLIT	NBR
150	178	16	M 12021 H1L5	LPD	NBR
150	180	15	M 18745 H1L5	RUP	NBR
150	181	16	M 14968 H1L5	RPD	NBR
150	181	16	M 14968 H1L5 PT	RPD	N/P
151	178	14	M 10258 H1L5	LPD	NBR
151	178	14	M 10263 H1L5	LPDW	NBR
152	178	11	M 16079 H1L5	LDS	NBR
152	178	11	M 17861 H1L5	LUPW	NBR
152	181	16	M 12196 H1L5	LUP	NBR
153	178	11	M 3714 H1L5	RPD	NBR
153	178	13	M 17956 H1L5	LUPW	NBR
153	178	16	M 15803 H1L5	STLDS	NBR
153	181	14	M 4337 H1L5	RPD	NBR
153	184	12	M 8940 H1L5	LPD	NBR
154	181	13	M 7141 H1L5	LUP	NBR
156	181	13	M 10311 H1L5	LUP	NBR
156	181	13	M 12737 H1L5	RPD	NBR
156	181	16	M 10381 H1L5	LPD	NBR
157	184	13	M 13475 H1L5	RPD	NBR
159	184	11	M 10439 H1L5	LUP	NBR
159	184	11	M 9795 H1L5	RUP	NBR
159	197	19	M 8949 H1L5	LUP	NBR

See Section 4 for seal type description. For FlexiSeal Listings see Page C-22.

03/03/06



Rotary Lip Seal Metric Sizes

Shaft Dia.	Bore Dia.	Seal Width	Parker Part Number	Seal Type	Material
159	203	19	M 15750 H1L5	LDS	NBR
160	188	15.8	M 0160 5350	SPLIT	NBR
160	190	15	M 18671 H1L20	LUP	XNBR
160	190	15	M 18671 H1L5	LUP	NBR
160	191	16	M 0160 4254	SPLIT	NBR
160	192	15.8	M 0160 14037	SPLIT	NBR
160	195	12.7	M 0160 14697	SPLIT	NBR
162	194	16	M 0162 6700	SPLIT	NBR
162	197	13	M 16828 H1L5	LUPW	NBR
162	200	16	M 6916 H1L5	LPD	NBR
162	200	19	M 9435 H1L5	RUP	NBR
164	177	11	M 12147 H1L7	P	NBR
164	190	14	M 30145 H1L5	LUP	NBR
164	197	13	M 11334 H1L5	LUP	NBR
165	185	12	M 18724 ALLL5	SS	NBR
165	190	15	M 30222 H1L5	LUP	NBR
165	193	15.8	M 0165 5350	SPLIT	NBR
165	197	16	M 10715 H1L5	LPD	NBR
165	197	16	M 10715 H5L16PT	LPD	F/P
165	197	16	M 14037 H1L5	RPD	NBR
165	198	16	M 10715 H1L20	LUP	XNBR
165	200	13	M 14697 H1L5	RPD	NBR
165	203	19	M 16762 H1L5	LDS	NBR
165	203	19	M 8950 H1L5	LUP	NBR
168	200	16	M 6700 H1L5	RPD	NBR
168	203	19	M 9972 H1L5	LUP	NBR
170	194	11.1	M 0170 4385	SPLIT	NBR
170	200	15	M 19767 H5L16	LUP	FKM
170	200	15	M 19767 H1L5	STLUP	NBR
170	208	15.8	M 0170 16413	SPLIT	NBR
171	197	13	M 10041 H1L5	LPD	NBR
171	197	19	M 16215 H1L5	LUPW	NBR
171	203	16	M 9048 H1L5	LUP	NBR
172	200	4	M 12106 H1L7	SS	NBR
172	200	16	M 5350 H1L5	RPD	NBR
175	200	15	M 80175 H1L5	MIST	NBR
175	203	16	M 10383 H1L5	LUP	NBR
175	206	16	M 0175 4254	SPLIT	NBR
175	213	16	M 9931 H1L5	LUP	NBR
178	203	12	M 3892 H1L5	LUP	NBR
178	203	13	M 13240 H1L5	LDS	NBR
178	203	16	M 6862 H1L5	LPD	NBR
178	203	19	M 10063 H1L5	LPD	NBR
178	216	16	M 9304 H1L5	LUP	NBR
178	216	19	M 11577 H1L5	LUP	NBR
180	205.4	11.1	M 0180 4385	SPLIT	NBR
180	205.4	15.8	M 0180 4218	SPLIT	NBR
180	210	15	M 18440 H1L5	LUP	NBR
180	210	15	M 18440 H5L89	LUP	FKM
180	210	15	M 0180 18744	SPLIT	NBR
180	215	15.8	M 0180 13659	SPLIT	NBR
180	220	15	M 15173 H1L5	RPD	NBR
181	203	14	M 12325 H1L5	LPD	NBR
181	216	16	M 10379 H1L5	LUP	NBR
181	216	16	M 12997 H1L5	RPD	NBR
181	219	16	M 16413 H1L5	RUP	NBR
181	219	19	M 12481 H1L5	LUP	NBR
183	230	16	M 9093 H1L5	RUP	NBR
184	216	16	M 10027 H1L5	LUP	NBR
184	216	16	M 5420 H1L5	RUP	NBR
184	219	16	M 13659 H1L5	RUP	NBR
185	200	12	M 15126 H1L5	P	NBR
185	210	15.8	M 0185 12522	SPLIT	NBR
185	215	15	M 0185 18744	SPLIT	NBR
187	219	19	M 11266 H1L5	RUP	NBR
190	215	16	M 9962 H1L5	LPD	NBR

Shaft Dia.	Bore Dia.	Seal Width	Parker Part Number	Seal Type	Material
190	220	15	M 18744 H1L5	RUP	NBR
190	222	16	M 0190 4558	SPLIT	NBR
190	230	13	M 9973 H1L5	LUP	NBR
190	230	16	M 30092 H1L5	LUP	NBR
190	230	16	M 80065 H1L5	MIST	NBR
190	235	16	M 15745 H1L5	LUP	NBR
191	216	13	M 11693 H1L5	LPD	NBR
191	216	15	M 13455 ALLL7	P	NBR
191	216	16	M 15367 H1L5	LPD	NBR
191	216	16	M 12522 H1L5	RUP	NBR
191	257	36	M 13810 H1L5	LDS	NBR
194	219	13	M 5291 H1L5	LUP	NBR
195	220	11.1	M 0195 3774	SPLIT	NBR
196	217	9	M 30158 H1L5	LUP	NBR
196	234	19	M 0196 10787	SPLIT	NBR
196	234	19	M 0196 10787 V	SPLIT	FKM
197	235	16	M 15527 H1L5	LDS	NBR
197	235	16	M 10688 H1L5	LPD	NBR
197	235	16	M 17444 H1L5	LUPW	NBR
197	235	19	M 8952 H1L5	LUP	NBR
197	238	16	M 15460 H1L5	LPDW	NBR
200	225	11.1	M 0200 3774	SPLIT	NBR
200	225	15	M 80164 H1L5	MIST	NBR
200	226	15	M 19036 H1L5	LUP	NBR
200	230	15	M 18528 H1L5	LUP	NBR
200	230	15	M 30093 H1L5	LUP	NBR
200	238	16	M 9886 H1L5	LUP	NBR
200	238	19	M 10021 H1L5	LUP	NBR
200	238	19	M 10021 H5L16	LUP	FKM
200	238	19	M 10787 H1L5	RUP	NBR
200	238	19	M 0200 14282	SPLIT	NBR
200	240	16	M 18950 H1L5	LUP	NBR
200	240	16	M 18950 H5L16	LUP	FKM
203	235	16	M 16865 H1L5	LDS	NBR
203	235	16	M 11035 H1L5	LUP	NBR
203	254	16	M 16311 H1L5	LUP	NBR
203	254	17	M 14198 H1L5	LUP	NBR
203	254	23	M 15076 H1L5	LDS	NBR
205	230	11	M 0205 3774	SPLIT	NBR
205	243	19	M 14282 H1L5	RPD	NBR
206	238	16	M 10656 H1L5	LUP	NBR
208	250	16	M 30146 H1L5	LUP	NBR
210	235	11	M 3774 H1L5	RUP	NBR
210	235	16	M 16220 H1L5	LUP	NBR
210	240	15	0210 18676 V	SPLIT	FKM
213	251	17	M 6718 H1L5	LUP	NBR
214	254	16	M 16551 H1L5	LUP	NBR
216	248	15.8	RM 0216 9857	SPLIT	NBR
216	254	16	M 10371 H1L5	LUP	NBR
216	254	16	M 4118 H1L5	RUP	NBR
216	254	19	M 15382 H1L5	LDS	NBR
216	254	19	M 6633 H1L5	RUP	NBR
216	270	25	M 15024 H1L5	LDS	NBR
219	254	13	M 16988 H1L5	LUP	NBR
219	270	19	M 12441 H1L5	LPD	NBR
220	250	15	M 18676 H5L16	RUP	FKM
220	250	15	M 30165 H1L5	RUP	NBR
220	250	15	M 17208 H1L5	STLUP	NBR
220	260	16	M 80133 H1L5	MIST	NBR
222	254	16	M 9557 H1L5	LUP	NBR
222	254	16	M 9857 H1L5	RUP	NBR
222	273	19	M 13789 H1L5	LUP	NBR
225	257	16	M 10333 H1L5	LUP	NBR
229	254	11	M 5280 H1L5	RPD	NBR
229	254	12	M 5386 H1L5	LUP	NBR
229	254	19	M 11552 H1L5	LUP	NBR



See Section 4 for seal type description. For FlexiSeal Listings see Page C-22.

03/03/06



Rotary Lip Seal Metric Sizes

230 to 527

C

Shaft Dia.	Bore Dia.	Seal Width	Parker Part Number	Seal Type	Material
230	260	15	M 30097 H5L16	LUP	FKM
230	262	15.8	M 0230 9823	SPLIT	NBR
235	273	17	M 14370 H1L5	LUP	NBR
240	275	15	M 30161 H1L5	LUP	NBR
241	267	11	M 3775 H1L5	RUP	NBR
241	273	16	M 16560 H1L5	LUP	NBR
241	273	16	M 9823 H1L5	RUP	NBR
241	292	19	M 9568 H1L5	RUP	NBR
241	292	21	M 17855 H1L5	LUPW	NBR
241	292	25	M 8824 H1L5	LUP	NBR
242	292	25	M 17382 H1L5	LPDW	NBR
248	273	13	M 5604 H1L5	RUP	NBR
248	279	16	M 12465 H5L16	LPD	FKM
250	290	16	M 30055 H1L5	LUP	NBR
251	293	19	M 0251 12323	SPLIT	NBR
253	294	19	M 0253 12323	SPLIT	NBR
254	292	16	M 12529 H1L5	LUP	NBR
254	305	21	M 16365 H1L5	LUP	NBR
254	305	21	M 16563 H1L5	LUPW	NBR
254	305	25	M 3794 H1L5	RPD	NBR
259	284	13	M 10954 H1L5	RUP	NBR
260	298	16	M 0260 3689 V	SPLIT	NBR
260	311	19	M 9742 H1L5	RUP	NBR
260	311	25	M 4873 H1L5	LUP	NBR
260	311	25	M 0260 9094	SPLIT	NBR
262	300	15.8	M 0262 3689	SPLIT	NBR
264	295	16	M 15713 H1L5	RPD	NBR
265	297	15.8	M 0265 4384	SPLIT	NBR
265	316	25	M 0265 9094	SPLIT	NBR
267	292	13	M 18723 H1L5	LUP	NBR
267	305	16	M 3689 H1L5	RUP	NBR
267	324	32	M 9347 H1L5	LPDW	NBR
270	295	16	M 20525 H1L5	H	NBR
270	310	16	M 80165 H1L5	MIST	NBR
270	310	20	M 30221 H5L16	LUP	FKM
273	305	16	M 4384 H1L5	RUP	NBR
273	311	14	M 16569 H1L5	LUP	NBR
273	324	14	M 16570 H1L5	LUP	NBR
273	324	25	M 18217 H1L5	LUP	NBR
273	324	25	M 9094 H1L5	RUP	NBR
275	310	16	M 80167 H1L5	MIST	NBR
275	310	16	M 80174 H1L5	MIST	NBR
275	315	18	M 80178 H1L5	MIST	NBR
279	311	17	M 11335 H1L5	LPD	NBR
279	330	16	M 7180 H1L5	LUP	NBR
279	330	16	M 7180 H5L16	LUP	FKM
280	305	16	M 11746 H1L5	LUP	NBR
280	311	16	M 18828 H1L5	LDS	NBR
280	320	20	M 18679 H1L5	LUP	NBR
280	320	20	M 18679 H5L16	LUP	FKM
285	336	22.2	M 0285 3723	SPLIT	NBR
286	324	16	M 10697 H1L5	LUP	NBR
289	330	19	M 12680 H1L5	LDS	NBR
292	324	16	M 9574 H1L5	LUP	NBR
292	324	16	M 5422 H1L5	RUP	NBR
292	330	18	M 9019 H1L5	LUP	NBR
292	343	22	M 3723 H1L5	RPD	NBR
292	343	25	M 10509 H1L5	LUP	NBR
297	332	19	M 10530 H1L5	RUP	NBR
300	338	19	M 0300 8433	SPLIT	NBR
305	343	15	M 16401 H1L7	P	NBR
305	343	17	M 17136 H1L5	LUP	NBR
305	343	19	M 16082 H1L5	LDS	NBR
305	343	19	M 8433 H1L5	RUP	NBR
305	346	19	M 14267 H1L5	LPD	NBR
310	354	20	M 30108 H1L5	LUP	NBR

Shaft Dia.	Bore Dia.	Seal Width	Parker Part Number	Seal Type	Material
311	362	29	M 15355 H1L5	LDS	NBR
315	365	20	M 18559 H1L5	LUP	NBR
317	355	13	M 30167 H1L5	LUP	NBR
318	343	13	M 11527 H1L5	LUP	NBR
320	360	18	M 80176 H1L5	MIST	NBR
320	364	19	M 80134 H1L5	MIST	NBR
322	419	26	M 12139 H1L5	LPDW	NBR
324	362	19	M 5641 H1L5	LPD	NBR
330	374	20	M 80179 H1L5	MIST	NBR
330	381	25	M 10093 H1L5	LUP	NBR
337	378	17	M 14872 H1L5	STLPD	NBR
340	380	20	M 30112 H1L5	LUP	NBR
343	381	19	M 5994 H1L5	RUP	NBR
343	381	19	M 15056 H1L5	STLUP	NBR
345	389	20	M 80177 H1L5	MIST	NBR
350	400	25	M 10660 H1L5	STLPD	NBR
356	413	25	M 6493 H1L5	LPD	NBR
360	400	17	M 80108 H1L5	MIST	NBR
362	400	19	M 17920 H1L5	LUPW	NBR
362	400	19	M 7058 H1L5	RUP	NBR
362	413	16	M 11750 H1L5	LUP	NBR
362	413	25	M 9447 H1L5	RUP	NBR
369	413	16	M 4253 H1L5	RPD	NBR
370	415	20	80144 STH1L5	STMIST	NBR
373	411	16	M 9419 H1L5	RPD	NBR
375	413	17	M 16581 H1L5	LUPW	NBR
375	419	25	M 9066 H1L5	STLUP	NBR
380	420	18	M 80109 H1L5	MIST	NBR
381	419	17	M 11025 H1L5	RUP	NBR
381	419	25	M 80013 H1L5	MIST	NBR
381	432	19	M 6334 H1L5	LUP	NBR
390	434	19	M 80132 H1L5	MIST	NBR
393	444	23	M 30159 H1L5	LUP	NBR
400	432	16	M 9376 H1L5	STLPD	NBR
400	438	14	M 17908 H1L5	LUPW	NBR
400	444	25.4	M 0400 9700	SPLIT	NBR
406	457	22	M 6854 H1L5	LUP	NBR
407	457	25	M 9981 H1L5	RUP	NBR
419	451	19	M 12138 H1L5	LUP	NBR
419	451	19	M 12138 H5L16	LUP	FKM
419	457	19	M 12507 H1L5	STLPD	NBR
426	457	19	M 19089 H1L5	RUP	NBR
438	489	25	M 9450 H1L5	RPD	NBR
440	470	20	M 19876 H5L16	LUP	FKM
440	480	20	M 30128 H1L5	LUP	NBR
440	500	25	M 80142 H1L5	STMIST	NBR
448	492	19	M 6811 H1L5	RUP	NBR
450	500	22	M 30198 H1L5	LUP	NBR
450	510	25	80143 STH1L5	STMIST	NBR
457	508	19	M 6661 H1L5	RPD	NBR
457	508	25	M 10425 H1L5	LPD	NBR
464	515	20.6	M 0464 6795	SPLIT	NBR
470	520	20	M 19641 H1L5	LUP	NBR
470	520	20	M 30001 H1L20	LUP	XNBR
470	521	19	M 3413 H1L5	RPD	NBR
470	521	22	M 16981 H1L5	LUPW	NBR
470	521	22	M 80028 H1L5	MIST	NBR
476	527	21	M 6795 H1L5	RPD	NBR
483	521	19	M 6855 H1L5	STLPD	NBR
489	540	25	M 14371 H1L5	RPD	NBR
490	540	22	80129 H1L5	MIST	NBR
495	546	22	M 16380 H1L5	LUPW	NBR
502	546	25	M 9446 H1L5	RUP	NBR
508	546	19	M 11409 H1L5	LPD	NBR
508	559	25	M 9150 H1L5	LUP	NBR
527	578	22	M 3630 H1L5	RPD	NBR

See Section 4 for seal type description. For FlexiSeal Listings see Page C-22.

03/03/06



Rotary Lip Seal Metric Sizes

Shaft Dia.	Bore Dia.	Seal Width	Parker Part Number	Seal Type	Material
527	578	25	M 80037 H1L5	MIST	NBR
540	590	23	M 80180 H1L5	MIST	NBR
546	597	16	M 3649 H1L5	RPD	NBR
549	600	22	M 6990 H1L5	LPD	NBR
554	605	20.6	M 0554 7085	SPLIT	NBR
559	597	8	M 80089 H1L5	MIST	NBR
559	597	19	M 14532 H1L5	LUP	NBR
560	610	22	M 30006 H1L5	LUP	NBR
560	610	22	M 80064 H1L5	MIST	NBR
565	616	21	M 7085 H1L5	RUP	NBR
584	635	22	M 8942 H1L5	LPD	NBR
584	635	22	M 8942 H1L5	LPD	NBR
584	635	25	M 11105 H1L5	STLPD	NBR
584	645	25	M 6822 H1L5	STLUP	NBR
591	654	25	M 15467 H1L5	RUP	NBR
597	648	25	M 13320 H1L5	STLPD	NBR
605	655	20	M 19640 H1L5	LUP	NBR
635	686	22	M 12572 H1L5	LPD	NBR
635	686	23	M 12594 H1L5	STLPD	NBR
661	689	13	M 11806 H1L5	RUP	NBR
661	721	19	M 18104 H1L5	RPD	NBR
673	711	19	M 15661 H1L5	STLUP	NBR

Shaft Dia.	Bore Dia.	Seal Width	Parker Part Number	Seal Type	Material
710	760	25	M 19794 H1L5	LUP	NBR
711	775	25	M 6841 H1L5	STLPD	NBR
724	775	22	M 16369 H1L5	STLUP	NBR
750	800	22	M 15958 H1L5	STLUP	NBR
762	813	22	M 12255 H1L5	STLPD	NBR
800	860	30	M 19795 H1L5	LUP	NBR
803	8524	25	M 16339 H1L5	RUPW	NBR
830	900	30	M 19733 H1L5	LUP	NBR
838	902	25	M 10131 H1L5	LUP	NBR
850	901	22	M 9845 H1L5	RPD	NBR
864	928	25	M 30200 H1L5	LUP	NBR
877	927	25	M 10274 H1L5	RPD	NBR
940	997	22	M 9456 H1L5	STLPD	NBR
960	1009	25.4	M 0960 8979	SPLIT	NBR
988	1051	3	M 15075 H1L5	RUP	NBR
1010	1059	25	M 8979 H1L5	RUP	NBR
1030	1094	19	M 1030 20583 V	SPLIT	FKM
1054	1105	22	M 16244 H1L5	STLUP	NBR
1068	1132	19	M 20583 H5L16	RUP	FKM
1380	1440	25	M 19846 H1L5	LDS	NBR

C

See Section 4 for seal type description. For FlexiSeal Listings see Page C-22.

03/03/06



Gland Dimensions — Metric FC & FH Profiles

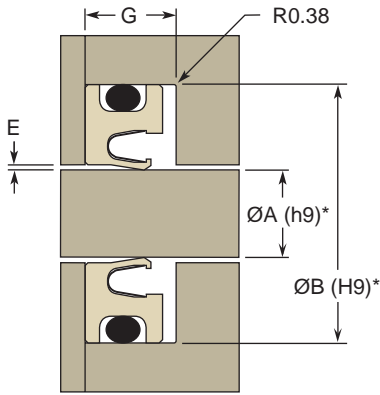

Rotary Seal

Cross-Section Callout	Gland Cross-Section	Std. Heel Height Callout	Ext. Heel Height Callout**	Std. Heel Groove Width (G) +0.25/-0.00 mm	Ext. Heel Groove Width (G) +0.25/-0.00 mm
0200	2.00 mm	021	036	2.39 mm	3.78 mm
0250	2.50 mm	033	042	3.58 mm	4.65 mm
0400	4.00 mm	043	056	4.78 mm	5.97 mm
0500	5.00 mm	066	079	7.14 mm	8.48 mm
0700	7.00 mm	090	114	9.53 mm	12.07 mm

Part Number	Shaft Ø (A) in mm	Groove Ø (B) in mm	Groove Width (G) in mm
FCS-V Profile			
M301FCS040006504043EVM	65.04 + .00/-0.07	73.04 + .07/-0.00	4.78 + 0.25/-0.00
FHC-C Profile			
M602FHC020000900036SCL	9.00 + .00/-0.04	13.00 + .04/-0.00	3.78 + 0.25/-0.00

Gland Dimensions — Metric FF Profiles, Flanged

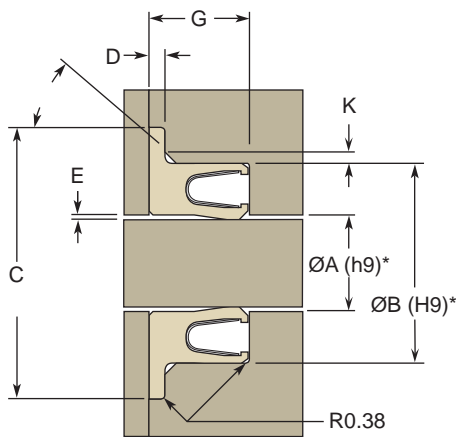

Cross-Section Callout	Gland Cross-Section	Heel Height Callout	Heel Groove Width (G) +0.25/-0.00 mm	Counter-Bore Depth (D)	Counter-Bore Min. Diameter (C)	Chamfer Size (K)
0200	2.00 mm	021	2.39 mm	0.28/0.33 mm	ØA + 7.81 mm	0.43 mm
0250	2.50 mm	033	3.58 mm	0.43/0.51 mm	ØA + 8.94 mm	0.71 mm
0400	4.00 mm	043	4.78 mm	0.61/0.69 mm	ØA + 12.75 mm	1.02 mm
0500	5.00 mm	066	7.14 mm	0.71/0.81 mm	ØA + 17.39 mm	1.45 mm
0700	7.00 mm	090	9.53 mm	1.04/1.14 mm	ØA + 22.18 mm	1.75 mm

Part Number	Shaft Ø (A) in mm	Groove Ø (B) in mm	Counter-Bore Ø (C) in mm	Counter-Bore Depth (D) in mm	Groove Width (G) in mm
FFC-V Profile					
M100FFC070012500090SVL	125.00 +.00/-0.10	139.00 +.10/-0.00	147.18 Min.	1.04/1.14	9.53 +0.25/-0.00
FFS-C Profile					
M301FFS020001100021HCH	11.00 +.00/-0.04	15.00 +.04/-0.00	18.81 Min.	0.28/0.33	2.39 +0.25/-0.00

See Section 4 for seal type description.

03/03/06

Solid to Split Seal Calculator - Inch

0.500 to 3.750

Catalog EPS 5350/USA

For directions on using this chart, see Page 5-30

Shaft Diameter Min. – Max.	Mold No.	Add to Shaft Diameter for Seal OD	Seal Width
0.500 – 0.563	7158	0.500	0.250
0.625 – 0.688	9237	0.500	0.250
0.625 – 0.688	9956	0.625	0.313
0.750 – 0.813	4187	0.500	0.312
0.938 – 1.001	16621	0.625	0.313
0.938 – 1.001	16893	0.750	0.375
1.000 – 1.063	6946	0.750	0.313
1.063 – 1.126	5692	0.750	0.250
1.125 – 1.188	4423	0.750	0.375
1.125 – 1.188	9659	0.812	0.375
1.125 – 1.188	17648	1.000	0.500
1.063 – 1.188	4287	0.750	0.438
1.250 – 1.375	3815	0.750	0.375
1.312 – 1.437	4186	0.688	0.437
1.313 – 1.438	4281	0.812	0.500
1.365 – 1.490	4459	0.760	0.375
1.375 – 1.500	6848	1.125	0.375
1.375 – 1.500	4399	1.000	0.438
1.500 – 1.625	9628	0.625	0.312
1.519 – 1.644	19578	0.825	0.393
1.562 – 1.687	6112	0.813	0.438
1.563 – 1.688	6047	1.005	0.688
1.625 – 1.750	17457	1.438	0.500
1.625 – 1.750	18156	0.625	0.375
1.688 – 1.813	3697	1.062	0.438
1.688 – 1.813	3716	0.750	0.438
1.688 – 1.813	5465	1.251	0.500
1.688 – 1.813	5828	0.937	0.500
1.710 – 1.835	5215	1.415	0.469
1.750 – 1.875	4504	1.319	0.469
1.750 – 1.875	17074	1.319	0.469
1.750 – 1.875	4162	0.875	0.437
1.750 – 1.875	6942	1.125	0.500
1.750 – 1.875	9818	0.716	0.375
1.750 – 1.875	13524	0.502	0.250
1.750 – 1.875	16227	0.563	0.250
1.809 – 1.934	17091	0.766	0.375
1.812 – 1.937	4274	0.938	0.469
1.813 – 1.938	9697	0.625	0.250
1.875 – 2.000	3625	1.000	0.438
1.875 – 2.000	7081	0.813	0.375
1.875 – 2.000	7131	0.750	0.375
1.875 – 2.000	18759	1.000	0.500
2.000 – 2.125	3930	1.250	0.500
2.000 – 2.125	4868	1.000	0.375
2.000 – 2.125	6207	1.184	0.500
2.000 – 2.125	19359	1.375	0.500
2.062 – 2.187	3838	0.938	0.438
2.062 – 2.187	6048	0.813	0.500
2.063 – 2.188	5865	1.125	0.375
2.063 – 2.188	6532	0.812	0.375
2.125 – 2.250	8486	1.000	0.438
2.125 – 2.250	17087	1.375	0.470
2.125 – 2.250	17628	0.750	0.500
2.230 – 2.355	19510	1.063	0.591
2.250 – 2.375	9074	1.000	0.438
2.250 – 2.375	5474	2.250	0.469
2.250 – 2.375	9648	0.816	0.375

Shaft Diameter Min. – Max.	Mold No.	Add to Shaft Diameter for Seal OD	Seal Width
2.250 – 2.375	16905	0.688	0.375
2.270 – 2.395	18522	0.788	0.512
2.313 – 2.438	6060	0.876	0.375
2.313 – 2.438	16098	1.125	0.438
2.370 – 2.495	4903	0.998	0.437
2.375 – 2.500	3707	0.750	0.375
2.375 – 2.500	4374	0.625	0.313
2.375 – 2.500	9055	0.875	0.437
2.375 – 2.500	17413	1.250	0.438
2.375 – 2.500	17932	1.043	0.500
2.438 – 2.563	3911	1.062	0.500
2.438 – 2.563	19585	0.692	0.500
2.500 – 2.625	8863	1.000	0.437
2.501 – 2.626	19577	0.786	0.393
2.563 – 2.688	5871	1.312	0.438
2.563 – 2.688	10230	1.000	0.500
2.624 – 2.749	19509	0.984	0.591
2.625 – 2.750	4107	1.128	0.500
2.625 – 2.750	16390	1.000	0.375
2.625 – 2.750	17472	0.793	0.483
2.625 – 2.750	18235	0.625	0.313
2.688 – 2.813	5464	0.813	0.500
2.625 – 2.875	4314	1.250	0.500
2.625 – 2.875	9370	1.000	0.500
2.688 – 2.938	8472	0.125	0.375
2.781 – 3.031	315	0.751	0.438
2.813 – 3.063	7036	1.062	0.500
2.875 – 3.125	8985	2.005	0.469
2.875 – 3.125	4054	1.125	0.500
2.875 – 3.125	12400	0.875	0.500
2.906 – 3.156	8918	0.969	0.500
2.938 – 3.188	8967	0.562	0.438
2.938 – 3.188	4225	0.937	0.438
2.971 – 3.221	16094	1.378	0.472
3.000 – 3.250	9272	1.250	0.625
3.063 – 3.313	4275	1.562	0.469
3.063 – 3.313	9215	0.750	0.375
3.125 – 3.375	9724	1.000	0.500
3.125 – 3.375	9728	0.750	0.438
3.125 – 3.375	10148	1.125	0.562
3.188 – 3.438	9001	1.312	0.625
3.188 – 3.438	10866	1.187	0.500
3.250 – 3.500	8966	1.365	0.469
3.250 – 3.500	7341	1.000	0.500
3.250 – 3.500	9763	1.375	0.469
3.250 – 3.500	14939	1.250	0.250
3.375 – 3.625	3693	1.250	0.625
3.500 – 3.750	3922	1.125	0.500
3.500 – 3.750	6765	1.000	0.500
3.500 – 3.750	7074	1.000	0.437
3.500 – 3.750	19334	1.125	0.563
3.563 – 3.813	9864	1.062	0.469
3.625 – 3.875	4417	0.750	0.438
3.625 – 3.875	9699	0.813	0.313
3.625 – 3.875	16819	0.875	0.500
3.688 – 3.938	5912	1.062	0.375
3.750 – 4.000	5823	1.500	0.500
3.750 – 4.000	10175	1.000	0.500



Above listed solid seals can be split to various sizes. For directions on how to use this chart, see Page 5-30.

03/03/06



Solid to Split Seal Calculator - Inch 3.830 to 6.587

For directions on using this chart, see Page 5-30

Shaft Diameter Min. - Max.	Mold No.	Add to Shaft Diameter for Seal OD	Seal Width
3.830 - 4.080	19576	1.228	0.590
3.875 - 4.125	9472	1.500	0.750
3.875 - 4.125	17022	0.875	0.500
3.938 - 4.188	12376	1.062	0.625
3.955 - 4.205	15323	1.576	0.512
4.000 - 4.250	15219	1.500	0.625
4.000 - 4.250	18449	1.000	0.694
4.081 - 4.331	14484	0.787	0.472
4.125 - 4.375	3588	1.000	0.438
4.188 - 4.438	8473	0.812	0.375
4.188 - 4.438	18703	1.437	0.484
4.223 - 4.473	19575	1.218	0.590
4.250 - 4.500	5260	1.751	0.625
4.250 - 4.500	5868	1.000	0.438
4.250 - 4.500	6955	1.750	0.563
4.250 - 4.500	6382	1.250	0.500
4.250 - 4.500	9468	1.250	0.625
4.313 - 4.563	17141	1.562	0.625
4.349 - 4.599	15175	0.788	0.512
4.375 - 4.625	7165	1.500	0.750
4.375 - 4.625	8860	1.250	0.625
4.375 - 4.625	16707	1.500	0.500
4.375 - 4.625	17162	0.750	0.375
4.484 - 4.734	9236	1.250	0.563
4.500 - 4.750	4769	1.000	0.563
4.500 - 4.750	4924	1.625	0.500
4.500 - 4.750	6682	1.125	0.563
4.500 - 4.750	5322	1.125	0.563
4.500 - 4.750	18284	0.750	0.375
4.547 - 4.797	15310	1.377	0.591
4.562 - 4.812	12642	1.063	0.625
4.563 - 4.813	5143	1.312	0.562
4.563 - 4.813	5651	1.312	0.438
4.594 - 4.844	17424	0.781	0.375
4.616 - 4.866	19574	1.218	0.590
4.500 - 4.875	4037	1.500	0.563
4.500 - 4.875	9737	1.000	0.500
4.500 - 4.875	16029	1.125	0.625
4.500 - 4.875	17632	1.125	0.563
4.563 - 4.938	6260	1.312	0.563
4.563 - 4.938	12544	1.562	0.625
4.563 - 4.938	12563	1.812	0.875
4.563 - 4.938	13245	1.500	0.500
4.563 - 4.938	16497	1.062	0.500
4.618 - 4.993	15312	1.575	0.591
4.625 - 5.000	4212	1.250	0.563
4.625 - 5.000	6585	1.250	0.625
4.625 - 5.000	12621	1.813	0.625
4.625 - 5.000	13340	1.750	0.625
4.625 - 5.000	10788	1.000	0.500
4.688 - 5.063	11735	2.500	0.500
4.688 - 5.063	16086	2.812	0.500
4.688 - 5.063	18746	1.111	0.472
4.743 - 5.118	9957	1.181	0.472
4.750 - 5.125	3727	1.000	0.438
4.750 - 5.125	4484	1.125	0.625
4.750 - 5.125	3708	1.250	0.625
4.813 - 5.188	5085	1.000	0.438
4.813 - 5.188	5356	1.062	0.500
4.875 - 5.250	5649	1.375	0.563
4.875 - 5.250	6530	1.125	0.500
4.875 - 5.250	11487	1.500	0.750
4.875 - 5.250	12188	1.000	0.500
4.875 - 5.250	3918	1.250	0.625

Shaft Diameter Min. - Max.	Mold No.	Add to Shaft Diameter for Seal OD	Seal Width
5.000 - 5.375	5758	1.250	0.625
5.000 - 5.375	10231	1.250	0.500
5.000 - 5.375	10746	1.125	0.500
5.012 - 5.387	15313	1.575	0.591
5.063 - 5.438	12116	1.187	0.500
5.125 - 5.500	9002	2.063	0.625
5.125 - 5.500	3768	0.750	0.375
5.125 - 5.500	10786	1.500	0.750
5.125 - 5.500	14174	1.875	0.250
5.125 - 5.500	11070	1.250	0.625
5.125 - 5.500	12256	1.000	0.500
5.250 - 5.625	4286	1.250	0.625
5.313 - 5.688	3944	1.000	0.438
5.313 - 5.688	6163	2.059	0.875
5.375 - 5.750	14255	1.563	0.750
5.375 - 5.750	6617	1.000	0.500
5.375 - 5.750	9155	1.000	0.438
5.403 - 5.778	14968	1.222	0.625
5.406 - 5.781	15172	1.574	0.591
5.406 - 5.781	18745	1.181	0.591
5.438 - 5.813	6702	1.562	0.563
5.438 - 5.813	18182	1.250	0.625
5.500 - 5.875	3714	1.000	0.438
5.500 - 5.875	4337	1.125	0.563
5.500 - 5.875	4711	1.500	0.625
5.563 - 5.938	13145	4.000	1.000
5.625 - 6.000	7179	1.250	0.625
5.625 - 6.000	9455	1.563	0.563
5.625 - 6.000	12503	2.000	0.500
5.625 - 6.000	12737	1.000	0.500
5.625 - 6.000	9824	1.500	0.750
5.625 - 6.000	15951	1.500	0.625
5.625 - 6.000	17271	1.625	0.625
5.688 - 6.063	4241	1.312	0.625
5.688 - 6.063	9103	1.500	0.750
5.688 - 6.063	13475	1.062	0.500
5.750 - 6.125	8901	1.500	0.750
5.750 - 6.125	9795	1.000	0.437
5.750 - 6.125	17740	1.202	0.734
5.750 - 6.125	18277	1.250	0.469
5.813 - 6.188	16353	1.062	0.500
5.875 - 6.250	4345	1.000	0.500
5.875 - 6.250	4548	1.250	0.625
5.875 - 6.250	9435	1.500	0.750
6.000 - 6.375	3863	1.000	0.438
6.000 - 6.375	14037	1.250	0.625
6.000 - 6.375	14697	1.375	0.500
6.125 - 6.500	4472	1.500	0.750
6.125 - 6.500	5679	1.500	0.688
6.125 - 6.500	6700	1.250	0.625
6.125 - 6.500	10747	1.000	0.625
6.125 - 6.500	11974	1.000	0.500
6.250 - 6.625	5350	1.125	0.625
6.250 - 6.625	11426	2.000	1.000
6.250 - 6.625	18498	1.875	1.000
6.299 - 6.674	19123	1.181	0.591
6.375 - 6.750	10461	1.750	0.750
6.375 - 6.750	9209	1.500	0.750
6.500 - 6.875	13523	4.000	1.000
6.500 - 6.875	15453	1.509	0.625
6.500 - 6.875	3991	1.375	0.625
6.563 - 6.938	4254	1.250	0.625
6.563 - 6.938	10476	1.500	0.500
6.587 - 6.962	15173	1.574	0.591

Above listed solid seals can be split to various sizes. For directions on how to use this chart, see **Page 5-30**. 03/03/06



For directions on using this chart, see Page 5-30

Shaft Diameter Min. – Max.	Mold No.	Add to Shaft Diameter for Seal OD	Seal Width
6.625 – 7.000	9658	2.000	0.625
6.625 – 7.000	12997	1.375	0.625
6.625 – 7.000	13121	1.500	0.750
6.625 – 7.000	16413	1.500	0.625
6.688 – 7.063	9093	1.875	0.625
6.750 – 7.125	4005	1.625	0.625
6.750 – 7.125	4385	1.000	0.438
6.750 – 7.125	5420	1.250	0.625
6.750 – 7.125	13659	1.375	0.625
6.813 – 7.188	9713	1.312	0.750
6.875 – 7.250	4218	1.000	0.625
6.875 – 7.250	11266	1.250	0.750
6.875 – 7.250	11342	1.000	0.438
6.928 – 7.303	19573	1.611	0.786
6.980 – 7.355	18744	1.182	0.591
7.000 – 7.375	12522	1.000	0.625
7.020 – 7.395	12257	0.980	0.438
7.125 – 7.500	8432	1.250	0.625
7.125 – 7.500	15465	1.500	0.750
7.156 – 7.531	13756	1.563	0.750
7.188 – 7.563	9420	1.500	0.750
7.250 – 7.625	3862	1.000	0.438
7.250 – 7.625	5089	1.500	1.000
7.250 – 7.625	18236	1.000	0.625
7.335 – 7.710	19572	1.614	0.787
7.375 – 7.750	10787	1.500	0.750
7.500 – 7.875	4558	1.250	0.625
7.500 – 7.875	8847	1.500	0.625
7.500 – 7.875	10497	1.000	0.438
7.563 – 7.938	14282	1.500	0.750
7.563 – 7.938	18802	0.819	0.344
7.625 – 8.000	17619	1.625	0.750
7.625 – 8.000	18075	1.250	0.625
7.688 – 8.063	10689	2.000	1.000
7.688 – 8.063	15335	1.000	0.500
7.750 – 8.125	12448	1.438	0.750
7.750 – 8.125	3581	1.500	0.625
7.750 – 8.125	3774	1.000	0.438
7.750 – 8.125	6511	1.250	0.625
7.768 – 8.143	30213	1.181	0.591
8.000 – 8.375	4905	1.000	0.438
8.000 – 8.375	19209	1.000	0.625
8.000 – 8.375	4118	1.500	0.625
8.000 – 8.375	6633	1.500	0.750
8.000 – 8.375	13552	1.250	0.688
8.063 – 8.438	15719	1.375	0.625
8.063 – 8.438	16351	1.375	0.625
8.161 – 8.536	18676	1.183	0.591
8.188 – 8.563	9372	1.250	0.750
8.188 – 8.563	12577	1.250	0.750
8.250 – 8.625	9857	1.250	0.625
8.344 – 8.719	13755	1.562	0.750
8.438 – 8.813	15735	1.500	0.375
8.500 – 8.875	5280	1.000	0.438
8.500 – 8.875	10276	2.000	1.000
8.500 – 8.875	12590	4.000	1.000
8.500 – 8.875	3577	1.250	0.625
8.500 – 8.875	3604	1.500	0.625
8.625 – 9.000	7236	2.000	1.000
8.662 – 9.037	19124	1.182	0.591
8.688 – 9.063	9123	0.750	0.375
8.688 – 9.063	14747	1.750	0.750
8.750 – 9.125	7087	2.000	0.750
9.000 – 9.375	3775	1.000	0.438

Shaft Diameter Min. – Max.	Mold No.	Add to Shaft Diameter for Seal OD	Seal Width
9.000 – 9.375	9568	2.000	0.750
9.000 – 9.375	9727	1.500	0.750
9.000 – 9.375	9823	1.250	0.625
9.188 – 9.563	10634	1.500	0.750
9.250 – 9.625	3924	2.000	1.000
9.250 – 9.625	5604	1.000	0.500
9.343 – 9.718	30214	1.181	0.591
9.250 – 9.812	3794	2.000	1.000
9.250 – 9.812	3704	1.000	0.594
9.313 – 9.875	12323	1.625	0.750
9.375 – 9.937	11205	4.000	1.000
9.438 – 10.000	15734	1.500	0.375
9.438 – 10.000	10954	1.000	0.500
9.438 – 10.000	15341	2.184	0.719
9.438 – 10.000	16364	1.250	0.500
9.500 – 10.062	3375	1.250	0.375
9.500 – 10.062	6512	1.000	0.750
9.500 – 10.062	9742	2.000	0.750
9.625 – 10.187	15407	1.875	1.000
9.674 – 10.236	15713	1.181	0.630
9.688 – 10.250	20753	1.562	0.750
9.704 – 10.266	19571	1.611	0.865
9.750 – 10.312	3689	1.500	0.625
9.750 – 10.312	6663	2.000	0.625
9.810 – 10.372	14111	2.378	1.250
9.938 – 10.500	15055	2.000	0.750
10.000 – 10.562	4384	1.250	0.625
10.000 – 10.562	9094	2.000	1.000
10.000 – 10.562	18843	2.125	1.000
10.188 – 10.750	11346	1.250	0.625
10.188 – 10.750	16601	1.750	0.563
10.250 – 10.812	3942	1.500	0.625
10.250 – 10.812	10349	1.500	0.750
10.438 – 11.000	11276	1.000	0.500
10.438 – 11.000	13848	1.000	0.625
10.500 – 11.062	3553	2.000	0.813
10.500 – 11.062	4673	1.250	0.625
10.500 – 11.062	5969	1.500	0.625
10.500 – 11.062	9934	2.000	0.938
10.667 – 11.229	30215	1.575	0.591
10.750 – 11.312	3723	2.000	0.875
10.750 – 11.312	12064	1.625	1.000
10.750 – 11.312	5422	1.250	0.625
10.813 – 11.375	9312	2.125	1.250
10.875 – 11.437	10224	1.500	1.000
10.938 – 11.500	14270	1.250	0.625
10.938 – 11.500	10530	1.375	0.750
11.000 – 11.562	9599	2.000	1.000
11.188 – 11.750	16404	2.000	0.625
11.250 – 11.812	8433	1.500	0.750
11.438 – 12.000	16026	1.000	0.563
11.438 – 12.000	9424	1.500	0.625
11.500 – 12.062	3676	1.500	0.750
11.750 – 12.312	3818	2.000	0.875
11.750 – 12.312	4198	1.250	0.625
11.750 – 12.312	6390	2.000	0.750
11.875 – 12.437	19389	1.875	1.000
12.000 – 12.562	5881	2.000	1.000
12.125 – 12.687	13851	3.813	1.031
12.188 – 12.750	17717	0.875	0.563
12.250 – 12.812	9459	1.500	0.750
12.250 – 12.812	12301	1.500	0.750
12.312 – 12.874	20752	1.626	0.750
12.500 – 13.062	10890	2.000	0.750



Above listed solid seals can be split to various sizes. For directions on how to use this chart, see **Page 5-30**.

03/03/06



Solid to Split Seal Calculator - Inch 12.500 to 64.625

For directions on using this chart, see Page 5-30

Shaft Diameter Min. – Max.	Mold No.	Add to Shaft Diameter for Seal OD	Seal Width
12.500 – 13.062	6660	1.500	0.625
12.750 – 13.312	11034	4.000	1.000
12.750 – 13.312	5994	1.500	0.750
12.938 – 13.500	11587	1.500	1.000
13.188 – 13.750	16183	1.500	0.500
13.250 – 13.812	9521	2.000	1.000
13.250 – 13.812	9856	1.500	0.625
13.500 – 14.062	7058	1.500	0.750
13.500 – 14.062	9447	2.000	1.000
13.688 – 14.250	15464	1.500	0.625
13.750 – 14.312	4253	1.750	0.625
13.817 – 14.379	30216	1.575	0.787
13.875 – 14.437	13204	1.500	0.750
13.938 – 14.500	9419	1.500	0.625
13.875 – 14.750	11025	1.500	0.688
13.875 – 14.750	19554	1.750	0.625
14.125 – 15.000	12631	1.500	0.750
14.210 – 15.085	11950	3.540	0.875
14.375 – 15.250	10531	1.375	0.531
14.375 – 15.250	6662	2.000	0.875
14.479 – 15.354	17464	1.370	0.531
14.500 – 15.375	3736	1.875	0.875
14.875 – 15.750	10876	4.000	1.000
14.875 – 15.750	9981	2.000	1.000
15.125 – 16.000	9700	1.750	1.000
15.125 – 16.000	13563	2.000	0.828
15.125 – 16.000	15576	2.000	1.500
15.375 – 16.250	3587	2.500	0.875
15.375 – 16.250	3587 – S	2.500	0.875
15.410 – 16.285	30211	1.575	0.787
15.625 – 16.500	19089	1.250	0.750
15.875 – 16.750	13674	2.000	0.813
15.875 – 16.750	3919	2.000	0.875
16.000 – 16.875	20680	1.125	0.500
16.125 – 17.000	9450	2.000	1.000
16.125 – 17.000	6286	1.500	0.625
16.504 – 17.379	6811	1.746	0.750
16.625 – 17.500	9624	2.000	0.813
16.875 – 17.750	6661	2.000	0.750
17.125 – 18.000	7157	3.000	1.500
17.125 – 18.000	9554	1.500	0.750
17.125 – 18.000	15466	2.000	0.813
17.125 – 18.000	40020	1.875	0.938
17.375 – 18.250	3413	2.000	0.750
17.375 – 18.250	15513	1.500	0.750
17.375 – 18.250	20750	1.000	0.500
17.625 – 18.500	6795	2.000	0.813
18.125 – 19.000	14371	2.000	1.000
18.375 – 19.250	3805	2.000	1.000
18.625 – 19.500	9577	2.250	1.000
18.625 – 19.500	9446	1.750	1.000
18.813 – 19.688	3791	1.750	0.625
18.250 – 20.000	9785	2.125	1.000
18.750 – 20.500	3630	2.000	0.875
19.000 – 20.750	6659	2.000	0.625
19.250 – 21.000	17327	3.000	1.750

Shaft Diameter Min. – Max.	Mold No.	Add to Shaft Diameter for Seal OD	Seal Width
19.500 – 21.250	3649	2.000	0.625
19.500 – 21.250	16354	3.000	1.000
19.750 – 21.500	6714	1.500	0.625
20.000 – 21.750	10312	1.750	0.813
20.250 – 22.000	14946	2.250	1.000
20.250 – 22.000	3839	2.000	1.000
20.250 – 22.000	7085	2.000	0.813
20.250 – 22.000	7086	1.500	0.625
20.441 – 22.191	30217	1.968	0.787
20.500 – 22.250	3985	1.760	0.750
21.250 – 23.000	6847	2.000	0.813
21.250 – 23.000	15467	2.500	1.000
21.500 – 23.250	15095	2.000	0.813
22.250 – 24.000	9340	2.500	1.000
22.250 – 24.000	16960	1.813	0.844
22.750 – 24.500	11897	2.000	0.625
23.250 – 25.000	18486	1.500	0.750
24.000 – 25.750	18104	2.375	0.766
24.000 – 25.750	11806	1.125	0.500
24.000 – 25.750	16507	2.000	1.000
24.127 – 25.877	13699	2.123	0.766
24.250 – 26.000	13807	2.500	1.000
24.250 – 26.000	18245	2.500	1.125
24.250 – 26.000	18246	1.162	0.500
26.375 – 28.125	16420	1.125	0.500
27.000 – 28.750	19245	2.375	1.000
27.750 – 29.500	17390	2.000	0.875
27.000 – 29.625	9375	2.500	1.000
27.375 – 30.000	11300	2.000	0.813
27.375 – 30.000	16377	1.125	0.500
27.375 – 30.000	16510	2.000	0.813
29.375 – 32.000	15370	2.500	1.250
29.756 – 32.381	18286	1.496	0.748
29.875 – 32.500	18722	1.125	0.563
30.131 – 32.756	18121	1.496	0.748
30.469 – 33.094	9845	2.000	0.875
31.375 – 34.000	17443	2.500	1.250
31.500 – 34.125	10274	2.000	1.000
33.500 – 36.125	4593	2.000	0.875
34.500 – 37.125	16700	2.000	1.000
34.875 – 37.500	17011	2.000	1.000
35.375 – 38.000	18433	1.625	0.750
35.875 – 38.500	15075	2.500	0.125
36.125 – 38.750	18565	1.938	1.000
36.750 – 39.375	8979	1.938	1.000
37.551 – 40.176	30162	1.968	0.984
40.125 – 42.750	13643	1.500	0.750
44.375 – 47.000	13644	1.500	0.750
45.125 – 47.750	10018	1.875	0.813
45.375 – 48.000	18450	2.000	0.813
48.000 – 52.625	11019	1.875	0.813
52.375 – 57.000	10492	3.000	1.500
54.500 – 59.125	11432	3.000	0.750
59.500 – 64.625	19704	3.000	0.750

D

Above listed solid seals can be split to various sizes. For directions on how to use this chart, see **Page 5-30**.

03/03/06



Solid to Split Seal Calculator - Metric

Catalog EPS 5350/USA

16 to 447

For directions on using this chart, see Page 5-30

Shaft Diameter Min. – Max.	Mold No.	Add to Shaft Diameter for Seal OD	Seal Width
16 – 17	M 9956 H1L5	16	8
19 – 20	M 4187 H1L5	13	8
22 – 23	M 4149 H1L5	13	8
27 – 28	M 15314 H1L5	20	10
34 – 37	M 3691 H1L5	22	11
39 – 42	M 5633 H1L5	25	13
42 – 45	M 9302 H1L5	33	11
43 – 46	M 5828 H1L5	24	13
44 – 47	M 15191 H1L5	20	10
45 – 48	M 4162 H1L5	22	11
48 – 51	M 7131 H1L5	19	9
48 – 51	M 6956 H1L5	27	13
55 – 58	M 19069 H1L5	24	13
57 – 60	M 19510 H1L5	27	15
59 – 62	M 15308 H1L5	25	10
61 – 64	M 9055 H1L5	22	11
61 – 64	M 3681 H1L5	25	11
64 – 67	M 7362 H1L5	15	8
64 – 67	M 15318 H1L5	20	10
64 – 67	M 19577 H1L5	20	10
66 – 69	M 15325 H5L89	23	10
66 – 69	M 9386 H1L5	28	12
69 – 72	M 5684 H1L5	17	9
70 – 73	M 4314 H1L5	32	13
68 – 75	M 8472 H1L5	19	9
70 – 77	M 3706 H1L5	28	13
71 – 78	M 7036 H1L5	27	13
73 – 80	M 8918 H1L5	25	13
75 – 82	M 15321 H1L5	25	12
75 – 82	M 16094 H1L5	35	12
79 – 86	M 9728 H1L5	19	11
80 – 87	M 15396 H1L5	20	12
85 – 92	M 15320 H1L5	25	12
90 – 97	M 9864 H1L5	27	12
92 – 99	M 9788 H1L5	25	11
98 – 105	M 10042 H1L5	19	14
100 – 107	M 13153 H1L5	30	13
100 – 107	M 15323 H1L5	40	13
104 – 111	M 5295 H1L5	32	13
109 – 116	M 3696 H1L5	27	13
110 – 117	M 15175 H1L5	20	13
110 – 117	M 15324 H1L5	30	15
114 – 121	M 17424 H1L5	22	9
114 – 121	M 4924 H1L5	41	13
115 – 122	M 15310 H1L5	35	15
116 – 126	M 6260 H1L5	33	14
117 – 127	M 4212 H1L5	32	14
117 – 127	M 6585 H1L5	32	16
117 – 127	M 15312 H1L5	40	15
119 – 129	M 18746 H1L5	28	12
120 – 130	M 9957 H1L5	30	12
120 – 130	M 3708 H1L5	32	16
121 – 131	M 4484 H1L5	28	16
124 – 134	M 12188 H1L5	25	13
124 – 134	M 6530 H1L5	28	13
127 – 137	M 15313 H1L5	40	15
130 – 140	M 3768 H1L5	19	9
130 – 140	M 10786 H1L5	38	19

Shaft Diameter Min. – Max.	Mold No.	Add to Shaft Diameter for Seal OD	Seal Width
133 – 143	M 4286 H1L5	32	16
137 – 147	M 18745 H1L5	30	15
137 – 147	M 14968 H1L5	31	16
140 – 150	M 3714 H1L5	25	11
140 – 150	M 4337 H1L5	28	14
143 – 153	M 12737 H1L5	25	13
144 – 154	M 13475 H1L5	27	13
146 – 156	M 9795 H1L5	25	11
149 – 159	M 9435 H1L5	38	19
152 – 162	M 14037 H1L5	32	16
152 – 162	M 14697 H1L5	35	13
155 – 165	M 6700 H1L5	32	16
159 – 169	M 5350 H1L5	28	16
167 – 177	M 15173 H1L5	40	15
168 – 178	M 12997 H1L5	35	16
168 – 178	M 16413 H1L5	38	16
170 – 180	M 9093 H1L5	47	16
171 – 181	M 5420 H1L5	32	16
171 – 181	M 13659 H1L5	35	16
174 – 184	M 11266 H1L5	32	19
177 – 187	M 18744 H1L5	30	15
178 – 188	M 12522 H1L5	25	16
187 – 197	M 10787 H1L5	38	19
192 – 202	M 14282 H1L5	38	19
197 – 207	M 3774 H1L5	25	11
203 – 213	M 4118 H1L5	38	16
203 – 213	M 6633 H1L5	38	19
207 – 217	M 18676 H5L16	30	15
209 – 219	M 9857 H1L5	32	16
216 – 226	M 5280 H1L5	25	11
228 – 238	M 3775 H1L5	26	11
228 – 238	M 9823 H1L5	32	16
228 – 238	M 9568 H1L5	51	19
235 – 245	M 5604 H1L5	25	13
241 – 251	M 3794 H1L5	51	25
240 – 254	M 10954 H1L5	25	13
241 – 255	M 9742 H1L5	51	19
245 – 259	M 15713 H1L5	31	16
248 – 262	M 3689 H1L5	38	16
254 – 268	M 4384 H1L5	32	16
254 – 268	M 9094 H1L5	51	25
273 – 287	M 5422 H1L5	32	16
273 – 287	M 3723 H1L5	51	22
278 – 292	M 10530 H1L5	35	19
286 – 300	M 8433 H1L5	38	19
324 – 338	M 5994 H1L5	38	19
343 – 357	M 7058 H1L5	38	19
343 – 357	M 9447 H1L5	51	25
350 – 364	M 4253 H1L5	44	16
354 – 368	M 9419 H1L5	38	16
362 – 376	M 11025 H1L5	38	17
378 – 401	M 9981 H1L5	50	25
397 – 420	M 19089 H1L5	31	19
409 – 432	M 9450 H1L5	51	25
419 – 442	M 6811 H1L5	44	19
428 – 451	M 6661 H1L5	51	19
441 – 464	M 3413 H1L5	51	19
447 – 470	M 6795 H1L5	51	21



Above listed solid seals can be split to various sizes. For directions on how to use this chart, see Page 5-30.

03/03/06



Solid to Split Seal Calculator - Metric 460 to 1000

For directions on using this chart, see Page 5-30

Shaft Diameter Min. – Max.	Mold No.	Add to Shaft Diameter for Seal OD	Seal Width
460 – 483	M 14371 H1L5	51	25
473 – 496	M 9446 H1L5	44	25
476 – 521	M 3630 H1L5	51	22
495 – 540	M 3649 H1L5	51	16
514 – 559	M 7085 H1L5	51	21
540 – 585	M 15467 H1L5	63	25

Shaft Diameter Min. – Max.	Mold No.	Add to Shaft Diameter for Seal OD	Seal Width
610 – 655	M 11806 H1L5	28	13
610 – 655	M 18104 H1L5	60	19
774 – 840	M 9845 H1L5	51	22
801 – 867	M 10274 H1L5	50	25
912 – 978	M 15075 H1L5	63	3
934 – 1000	M 8979 H1L5	49	25



Above listed solid seals can be split to various sizes. For directions on how to use this chart, see **Page 5-30**.

03/03/06



Sleeve & V-Seal Sizes

Catalog EPS 5350/USA

Dimensions — Quick Sleeve — Inch/Fractional

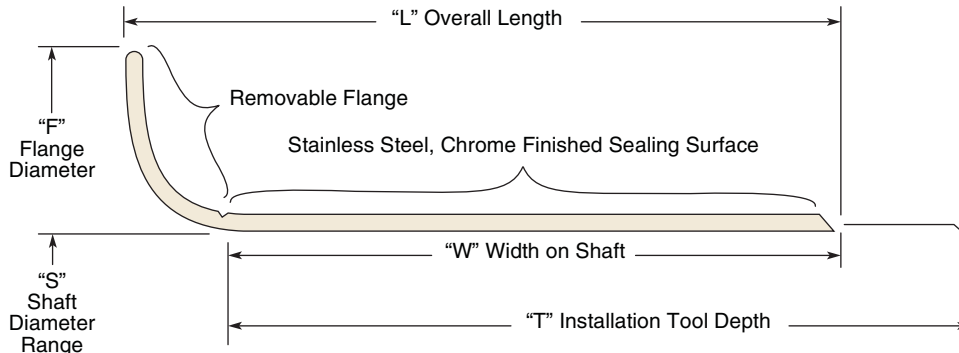

S		W	L	T	Sleeve Part Number
Min. Shaft Dia.	Max. Shaft Dia.	Width	Length	Installation Tool Depth	
0.622	0.630	0.315	0.437	2.032	99058
0.621	0.627	0.312	0.406	2.032	99062
0.746	0.752	0.312	0.437	2.032	99076
0.783	0.789	0.312	0.437	2.032	99078
0.871	0.877	0.312	0.437	2.032	99087
0.980	0.986	0.312	0.437	2.032	99098
0.995	1.002	0.312	0.437	2.032	99100
0.995	1.002	0.312	0.437	2.032	99101
1.123	1.127	0.312	0.438	0.688	99112
1.123	1.127	0.375	0.500	0.688	99116
1.245	1.253	0.312	0.437	0.875	99125
1.254	1.263	0.312	0.437	0.875	99128
1.368	1.374	0.500	0.625	1.000	99138
1.372	1.378	0.500	0.063	1.000	99139
1.432	1.438	0.563	0.688	1.016	99143
1.435	1.441	0.375	0.500	1.016	99144
1.496	1.503	0.562	0.688	1.016	99149
1.497	1.503	0.375	0.500	1.016	99150
1.519	1.526	0.438	0.563	1.016	99152
1.549	1.555	0.438	0.563	1.016	99155
1.559	1.565	0.563	0.688	1.016	99156
1.572	1.578	0.512	0.630	1.023	99157
1.622	1.628	0.562	0.688	0.812	99162
1.684	1.690	0.563	0.688	0.875	99168
1.647	1.653	0.563	0.689	0.827	99169
1.735	1.742	0.375	0.500	1.032	99170
1.745	1.753	0.375	0.500	1.032	99172
1.745	1.753	0.875	1.000	1.032	99173

S		W	L	T	Sleeve Part Number
Min. Shaft Dia.	Max. Shaft Dia.	Width	Length	Installation Tool Depth	
1.745	1.753	0.562	0.688	1.032	99174
1.745	1.753	0.750	0.875	1.032	99175
1.759	1.767	0.562	0.688	1.032	99176
1.767	1.775	0.550	0.669	1.032	99177
1.807	1.815	0.562	0.688	1.250	99181
1.869	1.878	0.562	0.688	1.250	99187
1.887	1.893	0.550	0.668	0.984	99189
1.909	1.915	0.375	0.500	1.000	99192
1.932	1.940	0.562	0.688	1.250	99193
1.965	1.971	0.550	0.668	0.984	99196
1.996	2.003	0.562	0.688	2.060	99199
1.996	2.003	0.875	1.000	2.060	99200
2.057	2.063	0.813	0.938	1.375	99205
2.122	2.128	0.500	0.750	1.280	99210
2.122	2.130	0.780	0.937	1.375	99212
2.185	2.192	0.781	0.938	1.312	99218
2.198	2.205	0.500	0.625	1.312	99220
2.248	2.255	0.780	0.937	1.375	99225
2.249	2.255	0.303	0.438	1.312	99227
2.359	2.365	0.787	0.905	1.375	99235
2.372	2.378	0.780	0.937	1.375	99237
2.372	2.378	0.594	0.750	1.375	99238
2.374	2.380	0.526	0.683	1.375	99240
2.359	2.365	0.370	0.450	1.375	99241
2.435	2.441	0.500	0.625	1.425	99242
2.434	2.440	0.781	0.938	1.393	99243
2.433	2.441	0.500	0.625	1.425	99244
2.497	2.506	0.500	0.656	1.393	99248

03/03/06



Sleeve & V-Seal Sizes

S		W	L	T	Sleeve Part Number
Min. Shaft Dia.	Max. Shaft Dia.	Width	Length	Installation Tool Depth	
2.487	2.506	0.780	0.937	1.393	99249
2.497	2.506	0.780	0.937	1.375	99250
2.509	2.516	0.780	0.906	1.375	99251
2.497	2.506	0.555	0.650	0.890	99253
2.554	2.562	0.787	0.905	1.375	99254
2.559	2.566	0.781	0.938	1.375	99256
2.595	2.601	0.781	0.938	1.250	99259
2.618	2.624	0.781	0.938	1.375	99261
2.623	2.631	0.780	0.937	1.500	99262
2.620	2.627	0.780	0.906	1.500	99264
2.750	2.756	0.406	0.563	1.250	99272
2.743	2.751	0.780	0.937	1.375	99274
2.748	2.756	0.780	0.937	1.375	99275
2.750	2.759	0.787	0.945	1.375	99276
2.837	2.844	0.500	0.656	1.250	99282
2.826	2.836	0.748	0.868	1.339	99284
2.871	2.879	0.780	0.937	1.375	99287
2.935	2.943	0.780	0.938	1.500	99293
2.949	2.956	0.866	1.024	1.312	99294
2.987	2.996	0.812	1.000	1.250	99299
2.998	3.006	0.812	1.000	1.281	99300
2.998	3.006	0.625	0.812	1.063	99303
3.123	3.132	0.550	0.709	2.031	99307
3.119	3.126	0.688	0.813	2.000	99311
3.119	3.126	0.812	1.000	2.000	99312
3.141	3.150	0.750	0.886	1.375	99313
3.145	3.153	0.827	0.945	1.375	99315
3.145	3.153	0.433	0.591	1.375	99317
3.246	3.253	0.812	1.000	1.375	99322
3.248	3.256	0.595	0.720	1.500	99324
3.248	3.256	0.812	1.000	1.500	99325
3.337	3.347	0.669	0.827	1.378	99332
3.337	3.347	0.827	0.894	1.378	99333
3.371	3.379	0.812	1.000	1.500	99337
3.495	3.503	0.625	0.812	1.348	99346
3.498	3.506	0.312	0.500	1.348	99347

S		W	L	T	Sleeve Part Number
Min. Shaft Dia.	Max. Shaft Dia.	Width	Length	Installation Tool Depth	
3.499	3.507	0.625	0.812	1.348	99349
3.498	3.506	0.812	1.000	1.347	99350
3.540	3.546	0.710	0.906	1.812	99351
3.540	3.546	0.526	0.667	1.750	99353
3.540	3.546	0.906	1.102	1.750	99354
3.560	3.566	0.812	1.000	1.750	99356
3.618	3.624	0.812	1.000	1.750	99360
3.622	3.629	0.812	1.000	1.750	99362
3.622	3.629	0.500	0.625	1.750	99363
3.739	3.746	0.469	0.594	1.750	99364
3.748	3.756	0.344	0.500	1.750	99367
3.736	3.743	0.827	0.945	1.750	99369
3.748	3.756	0.688	0.875	1.875	99372
3.739	3.746	0.344	0.500	1.750	99374
3.745	3.752	0.563	0.688	1.750	99376
3.873	3.879	0.812	1.000	1.875	99387
3.935	3.941	0.812	1.000	2.050	99393
3.995	4.006	0.600	0.725	2.125	99395
3.995	4.006	0.812	1.000	2.125	99399
3.995	4.006	0.650	0.775	2.125	99400
3.995	4.006	0.500	0.625	2.125	99401
4.248	4.256	0.812	1.000	1.438	99424
4.370	4.378	0.812	1.000	1.650	99437
4.496	4.504	0.813	1.000	1.250	99450
4.523	4.531	0.813	0.938	1.250	99452
4.916	4.925	1.024	1.260	1.438	99492
4.998	5.006	0.688	0.875	1.438	99498
4.998	5.006	0.813	1.000	1.438	99499
5.246	5.254	0.812	1.000	1.250	99525
5.498	5.506	0.812	1.000	1.250	99549
5.498	5.506	0.518	0.705	1.250	99550
5.508	5.516	0.807	1.000	1.250	99552
5.995	6.004	1.000	1.250	1.750	99599
5.995	6.004	0.500	0.750	1.750	99601
6.495	6.505	1.000	1.250	1.375	99650
6.994	7.005	1.000	1.250	1.688	99700

E



Dimensions — Quick Sleeve — Metric

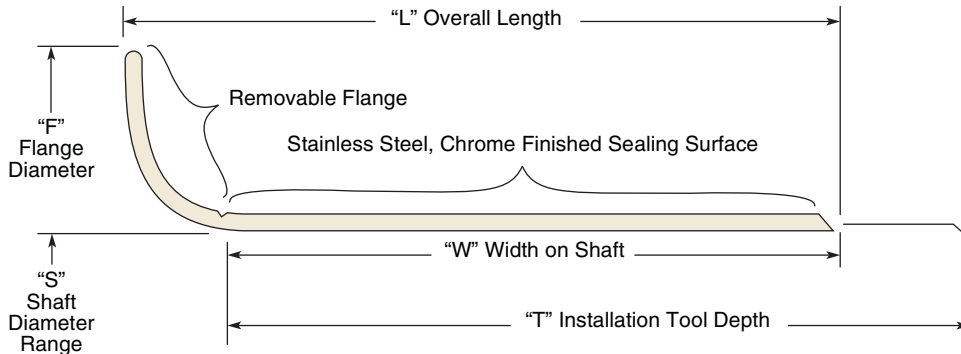

S		W	L	T	Sleeve Part Number
Min. Shaft Dia.	Max. Shaft Dia.	Width	Length	Installation Tool Depth	
15.80	16.00	8.0	11.1	51.6	99058
15.77	15.93	7.9	10.3	51.6	99062
18.95	19.10	7.9	11.1	51.6	99076
19.89	20.04	7.9	11.1	51.6	99078
22.12	22.28	7.9	11.1	51.6	99087
24.89	25.04	7.9	11.1	51.6	99098
25.27	25.45	7.9	11.1	51.6	99100
25.27	25.45	7.9	11.1	51.6	99101
28.52	28.63	7.9	11.1	17.5	99112
28.52	28.63	9.5	12.7	17.5	99116
31.62	31.83	7.9	11.1	22.2	99125
31.85	32.08	7.9	11.1	22.2	99128
34.75	34.90	12.7	15.9	25.4	99138
34.85	35.00	12.7	1.6	25.4	99139
36.37	36.53	14.3	17.5	25.8	99143
36.45	36.60	9.5	12.7	25.8	99144
38.00	38.18	14.3	17.5	25.8	99149
38.02	38.18	9.5	12.7	25.8	99150
38.58	38.76	11.1	14.3	25.8	99152
39.34	39.50	11.1	14.3	25.8	99155
39.60	39.75	14.3	17.5	25.8	99156
39.93	40.08	13.0	16.0	26.0	99157
41.20	41.35	14.3	17.5	20.6	99162
42.77	42.93	14.3	17.5	22.2	99168
41.83	41.99	14.3	17.5	21.0	99169
44.07	44.25	9.5	12.7	26.2	99170
44.32	44.53	9.5	12.7	26.2	99172
44.32	44.53	22.2	25.4	26.2	99173
44.32	44.53	14.3	17.5	26.2	99174
44.32	44.53	19.1	22.2	26.2	99175
44.68	44.88	14.3	17.5	26.2	99176
44.88	45.09	14.0	17.0	26.2	99177

S		W	L	T	Sleeve Part Number
Min. Shaft Dia.	Max. Shaft Dia.	Width	Length	Installation Tool Depth	
45.90	46.10	14.3	17.5	31.8	99181
47.47	47.70	14.3	17.5	31.8	99187
47.93	48.08	14.0	17.0	25.0	99189
48.49	48.64	9.5	12.7	25.4	99192
49.07	49.28	14.3	17.5	31.8	99193
49.91	50.06	14.0	17.0	25.0	99196
50.70	50.88	14.3	17.5	52.3	99199
50.70	50.88	22.23	25.40	52.32	99200
52.25	52.40	20.65	23.83	34.93	99205
53.90	54.05	12.70	19.05	32.51	99210
53.90	54.10	19.81	23.80	34.93	99212
55.50	55.68	19.8	23.8	33.3	99218
55.83	56.01	12.7	15.9	33.3	99220
57.10	57.28	19.8	23.8	34.9	99225
57.12	57.28	7.7	11.1	33.3	99227
59.92	60.07	20.0	23.0	34.9	99235
60.25	60.40	19.8	23.8	34.9	99237
60.25	60.40	15.1	19.1	34.9	99238
60.30	60.45	13.4	17.3	34.9	99240
59.92	60.07	9.4	11.4	34.9	99241
61.85	62.00	12.7	15.9	36.2	99242
61.82	61.98	19.8	23.8	35.4	99243
61.80	62.00	12.7	15.9	36.2	99244
63.42	63.65	12.7	16.7	35.4	99248
63.17	63.65	19.8	23.8	35.4	99249
63.42	63.65	19.81	23.80	34.93	99250
63.73	63.91	19.81	23.01	34.93	99251
63.42	63.65	14.10	16.51	22.61	99253
64.87	65.07	20.0	23.0	34.9	99254
65.00	65.18	19.8	23.8	34.9	99256
65.91	66.07	19.8	23.8	31.8	99259
66.50	66.65	19.8	23.8	34.9	99261



03/03/06



Sleeve & V-Seal Sizes

S		W	L	T	Sleeve Part Number
Min. Shaft Dia.	Max. Shaft Dia.	Width	Length	Installation Tool Depth	
66.62	66.83	19.81	23.80	38.10	99262
66.55	66.73	19.8	23.0	38.1	99264
69.85	70.00	10.3	14.3	31.8	99272
69.67	69.88	19.8	23.8	34.9	99274
69.80	70.00	19.8	23.8	34.9	99275
69.85	70.08	20.0	24.0	34.9	99276
72.06	72.24	12.7	16.7	31.8	99282
71.78	72.03	19.0	22.0	34.0	99284
72.92	73.13	19.8	23.8	34.9	99287
74.55	74.75	19.8	23.8	38.1	99293
74.90	75.08	22.0	26.0	33.3	99294
75.87	76.10	20.6	25.4	31.8	99299
76.15	76.35	20.6	25.4	32.5	99300
76.15	76.35	15.9	20.6	27.0	99303
79.32	79.55	14.0	18.0	51.6	99307
79.22	79.40	17.5	20.7	50.8	99311
79.22	79.40	20.6	25.4	50.8	99312
79.78	80.01	19.1	22.5	34.9	99313
79.88	80.09	21.0	24.0	34.9	99315
79.88	80.09	11.0	15.0	34.9	99317
82.45	82.63	20.6	25.4	34.9	99322
82.50	82.70	15.1	18.3	38.1	99324
82.50	82.70	20.6	25.4	38.1	99325
84.76	85.01	17.0	21.0	35.0	99332
84.76	85.01	21.0	22.7	35.0	99333
85.62	85.83	20.6	25.4	38.1	99337
88.77	88.98	15.9	20.6	34.2	99346
88.85	89.05	7.9	12.7	34.2	99348
88.87	89.08	15.9	20.6	34.2	99349
88.85	89.05	20.6	25.4	34.2	99350
89.92	90.07	18.0	23.0	46.0	99351
89.92	90.07	13.4	16.9	44.5	99353

S		W	L	T	Sleeve Part Number
Min. Shaft Dia.	Max. Shaft Dia.	Width	Length	Installation Tool Depth	
89.92	90.07	23.0	28.0	44.5	99354
90.42	90.58	20.6	25.4	44.5	99356
91.90	92.05	20.6	25.4	44.5	99360
92.00	92.18	20.6	25.4	44.5	99362
92.00	92.18	12.7	15.9	44.5	99363
94.97	95.15	11.9	15.1	44.5	99364
95.20	95.40	8.7	12.7	44.5	99367
94.89	95.07	21.0	24.0	44.5	99369
95.20	95.40	17.5	22.2	47.6	99372
94.97	95.15	8.7	12.7	44.5	99374
95.12	95.30	14.3	17.5	44.5	99376
98.37	98.53	20.6	25.4	47.6	99387
99.95	100.10	20.6	25.4	52.1	99393
101.47	101.75	15.2	18.4	54.0	99395
101.47	101.75	20.6	25.4	54.0	99399
101.47	101.75	16.5	19.7	54.0	99400
101.47	101.75	12.7	15.9	54.0	99401
107.90	108.10	20.6	25.4	36.5	99424
111.00	111.20	20.6	25.4	41.9	99437
114.20	114.40	20.7	25.4	31.8	99450
114.88	115.09	20.7	23.8	31.8	99452
124.87	125.10	26.0	32.0	36.5	99492
126.95	127.15	17.5	22.2	36.5	99498
126.95	127.15	20.7	25.4	36.5	99499
133.25	133.45	20.6	25.4	31.8	99525
139.65	139.85	20.6	25.4	31.8	99549
139.65	139.85	13.2	17.9	31.8	99550
139.90	140.11	20.5	25.4	31.8	99552
152.27	152.50	25.4	31.8	44.5	99599
152.27	152.50	12.7	19.1	44.5	99601
164.97	165.23	25.4	31.8	34.9	99650
177.65	177.93	25.4	31.8	42.9	99700

E



Dimensions — Wear Sleeve

All dimensions are in inch

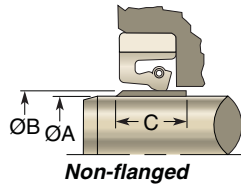

Non-flanged

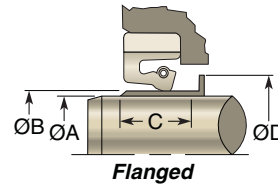

Flanged

Flanged	A	B	D	C	Material	Coating	Sleeve Part Number
	ID	OD	Flange OD	Sleeve Length			
NO	0.562	0.688		0.625	Plain Carbon Steel	Phosphate	WS1203
YES	0.625	0.750	0.937	0.562	Plain Carbon Steel	Phosphate	WS1182
NO	0.625	0.750		0.625	Plain Carbon Steel	Phosphate	WS1205
YES	0.747	0.872	0.937	0.625	Plain Carbon Steel	Phosphate	WS724
NO	0.750	0.875		0.500	Plain Carbon Steel	Phosphate	WS3
NO	0.781	0.875		0.555	Plain Carbon Steel	Phosphate	WS535
YES	0.789	0.911	1.109	0.500	Plain Carbon Steel	Phosphate	WS1183
NO	0.875	1.000		0.625	Plain Carbon Steel	Phosphate	WS723
YES	0.875	1.000	1.187	0.625	Plain Carbon Steel	Phosphate	WS725
YES	0.937	1.062	1.250	0.562	Plain Carbon Steel	Phosphate	WS1186
NO	0.938	1.062		0.625	Plain Carbon Steel	Phosphate	WS1448
NO	0.968	1.047		0.315	316 Stainless Steel	None	WS45
NO	0.984	1.125		0.938	Plain Carbon Steel	Phosphate	WS1920
NO	1.000	1.125		0.500	Plain Carbon Steel	Phosphate	WS5
YES	1.062	1.187	1.375	0.635	Plain Carbon Steel	Phosphate	WS726
NO	1.120	1.245		0.500	Plain Carbon Steel	Phosphate	WS695
NO	1.120	1.245		0.500	Plain Carbon Steel	Phosphate	WS696
NO	1.125	1.181		0.369	Cold Rolled Steel	None	WS52
NO	1.125	1.250		0.500	Plain Carbon Steel	Phosphate	WS6
NO	1.125	1.250		0.750	Plain Carbon Steel	Phosphate	WS7
YES	1.125	1.250	1.437	0.750	Plain Carbon Steel	Phosphate	WS746
YES	1.234	1.375	1.622	0.438	Plain Carbon Steel	Phosphate	WS706
NO	1.245	1.370		0.360	Plain Carbon Steel	Phosphate	WS691
YES	1.250	1.375	1.500	0.625	Plain Carbon Steel	Phosphate	WS700
NO	1.250	1.375		0.750	Plain Carbon Steel	Phosphate	WS1266
YES	1.250	1.375	1.558	0.750	304 Stainless Steel	None	WS2123
YES	1.250	1.375	1.562	0.755	Plain Carbon Steel	Phosphate	WS727
YES	1.292	2.047	2.430	0.300	Stainless Steel 304/316	None	WS25
NO	1.370	1.437		0.512	316 Stainless Steel	None	WS43
NO	1.375	1.485		0.294	Cold Rolled Steel	None	WS53
NO	1.375	1.500		0.500	Plain Carbon Steel	Phosphate	WS9
NO	1.375	1.500		0.750	Plain Carbon Steel	Phosphate	WS1204
NO	1.500	1.625		0.500	Plain Carbon Steel	Phosphate	WS10
NO	1.500	1.625		0.625	Plain Carbon Steel	Phosphate	WS1367
NO	1.500	1.625		0.750	Plain Carbon Steel	Phosphate	WS11
YES	1.500	1.625	1.812	0.750	Plain Carbon Steel	Phosphate	WS745
NO	1.562	1.687		0.625	Plain Carbon Steel	Phosphate	WS968
YES	1.562	1.687	1.875	0.750	Plain Carbon Steel	Phosphate	WS728



03/03/06

Sleeve & V-Seal Sizes

All dimensions are in inch

Flanged	A	B	D	C	Material	Coating	Sleeve Part Number
	ID	OD	Flange OD	Sleeve Length			
YES	1.563	1.688		0.750	Plain Carbon Steel	Phosphate	WS1906
YES	1.568	1.675	1.875	0.750	Plain Carbon Steel	Phosphate	WS1102
NO	1.609	1.750		0.250	Plain Carbon Steel	Phosphate	WS668
YES	1.619	1.744	2.375	0.687	Plain Carbon Steel	Phosphate	WS852
YES	1.625	1.685	2.000	0.625	Plain Carbon Steel	Phosphate	WS1169
NO	1.625	1.750		0.500	Plain Carbon Steel	Phosphate	WS8
NO	1.687	1.813		0.625	Plain Carbon Steel	Phosphate	WS1976
YES	1.812	1.937	2.312	0.625	Plain Carbon Steel	Phosphate	WS866
NO	1.903	1.930		0.625	Plain Carbon Steel	Phosphate	WS2244
YES	1.937	2.062	2.250	0.625	Plain Carbon Steel	Phosphate	WS729
NO	1.940	2.165		0.590	Plain Carbon Steel	Phosphate	WS67
NO	2.000	2.125		0.625	Plain Carbon Steel	Phosphate	WS969
NO	2.000	2.125		0.625	Plain Carbon Steel	Phosphate	WS2954
YES	2.000	2.125	2.312	0.687	Plain Carbon Steel	Phosphate	WS730
YES	2.000	2.125	2.308	0.687	304 Stainless Steel	None	WS2122
NO	2.000	2.125		1.000	316 Stainless Steel	None	WS1020
NO	2.000	2.165		0.590	Plain Carbon Steel	Phosphate	WS68
YES	2.062	2.188	2.375	0.750	Plain Carbon Steel	Phosphate	WS731
NO	2.125	2.250		0.656	316 Stainless Steel	None	WS2839
YES	2.125	2.250	2.375	0.750	Plain Carbon Steel	Phosphate	WS29
YES	2.125	2.250	2.625	0.765	Plain Carbon Steel	Phosphate	WS1123
NO	2.125	2.250		1.688	410 Or 416 Stainless Steel	None	WS1594
YES	2.216	2.338	2.531	0.750	Plain Carbon Steel	Phosphate	WS1579
YES	2.219	2.344	2.531	0.750	Plain Carbon Steel	Phosphate	WS917
YES	2.219	2.343	2.531	0.740	Plain Carbon Steel	Phosphate	WS2000
NO	2.230	2.350		0.500	316 Stainless Steel	None	WS2798
NO	2.250	2.375		0.563	Plain Carbon Steel	Phosphate	WS2489
NO	2.250	2.375		0.625	Plain Carbon Steel	Phosphate	WS2955
YES	2.312	2.437	2.625	0.750	Plain Carbon Steel	Phosphate	WS732
NO	2.312	2.438		0.750	304 Stainless Steel	Chrome	WS1826
NO	2.369	2.494		0.500	Stainless Steel 304/316	None	WS892
NO	2.369	2.494		1.125	Stainless Steel 304/316	None	WS902
YES	2.438	2.563	2.750	0.719	Plain Carbon Steel	Phosphate	WS2239
YES	2.451	2.563	2.688	0.375	Plain Carbon Steel	None	WS1884
NO	2.494	2.619		0.500	Stainless Steel 304/316	None	WS894
NO	2.494	2.619		1.125	Stainless Steel 304/316	None	WS901
NO	2.500	2.625		0.625	Plain Carbon Steel	Phosphate	WS810
NO	2.500	2.625		1.000	316 Stainless Steel	None	WS1021
NO	2.625	2.750		0.625	Plain Carbon Steel	Phosphate	WS811
NO	2.625	2.750		0.688	Plain Carbon Steel	Phosphate	WS2703
YES	2.625	2.750	2.937	0.750	Plain Carbon Steel	Phosphate	WS733
NO	2.625	2.750		0.750	Plain Carbon Steel	Phosphate	WS737
YES	2.625	2.750	2.937	0.750	304 Stainless Steel	None	WS1676
YES	2.625	2.750	2.933	0.750	304 Stainless Steel	None	WS2124
NO	2.625	2.750		1.500	Plain Carbon Steel	Phosphate	WS2494
NO	2.672	2.792		0.550	Plain Carbon Steel	Phosphate	WS936

03/03/06



All dimensions are in inch

Flanged	A	B	D	C	Material	Coating	Sleeve Part Number
	ID	OD	Flange OD	Sleeve Length			
NO	2.734	2.875		0.875	Plain Carbon Steel	Phosphate	WS677
NO	2.744	2.869		0.500	Stainless Steel 304/316	None	WS893
NO	2.744	2.869		0.625	Plain Carbon Steel	Phosphate	WS831
NO	2.744	2.869		1.125	Stainless Steel 304/316	None	WS903
NO	2.750	2.812		0.827	316 Stainless Steel	None	WS44
NO	2.750	2.875		0.688	Plain Carbon Steel	Phosphate	WS2702
NO	2.781	2.906		0.500	Plain Carbon Steel	Phosphate	WS1515
YES	2.812	2.937	3.156	1.000	Plain Carbon Steel	Phosphate	WS1206
NO	2.875	2.971		0.491	Plain Carbon Steel	Phosphate	WS926
NO	2.875	3.000		0.625	Plain Carbon Steel	Phosphate	WS12
YES	2.951	3.078	3.453	0.750	Plain Carbon Steel	Phosphate	WS1450
YES	2.953	3.078	3.453	0.750	Plain Carbon Steel	Phosphate	WS1017
YES	2.953	3.078	3.453	0.750	Plain Carbon Steel	Phosphate	WS1431
NO	2.994	3.119		0.625	Plain Carbon Steel	Phosphate	WS828
NO	3.000	3.125		1.000	316 Stainless Steel	None	WS1022
NO	3.000	3.125		1.500	Stainless Steel 304/316	None	WS31
NO	3.022	3.150		0.625	Plain Carbon Steel	Phosphate	WS1977
NO	3.063	3.375		0.750	Cold Rolled Steel	None	WS5904
NO	3.125	3.218		0.484	Plain Carbon Steel	Phosphate	WS928
NO	3.125	3.250		0.625	Plain Carbon Steel	Phosphate	WS23
NO	3.125	3.250		0.750	Plain Carbon Steel	Phosphate	WS778
YES	3.203	3.250	3.375	0.500	Plain Carbon Steel	None	WS1885
NO	3.234	3.375		1.250	Cold Rolled Steel	Armaloydiamond	WS65
NO	3.250	3.346		0.484	Plain Carbon Steel	Phosphate	WS924
NO	3.250	3.375		0.625	Plain Carbon Steel	Phosphate	WS1827
YES	3.250	3.375	3.562	0.750	Plain Carbon Steel	Phosphate	WS736
NO	3.296	3.625		0.437	Plain Carbon Steel	Phosphate	WS631
YES	3.312	3.437	3.625	0.812	Plain Carbon Steel	Phosphate	WS734
NO	3.346	3.500		1.187	Plain Carbon Steel	Phosphate	WS1815
NO	3.359	3.500		1.250	Cold Rolled Steel	Armaloydiamond	WS64
NO	3.375	3.500		0.625	Stainless Steel 304/316	None	WS22
NO	3.375	3.500		0.625	Plain Carbon Steel	Phosphate	WS1983
NO	3.375	3.500		0.625	Plain Carbon Steel	Phosphate	WS1984
NO	3.375	3.500		0.875	Plain Carbon Steel	Phosphate	WS1466
NO	3.384	3.500		0.750	Plain Carbon Steel	Phosphate	WS2064
NO	3.437	3.617		0.718	304 Stainless Steel	None	WS2076
NO	3.437	3.619		0.718	Plain Carbon Steel	Phosphate	WS944
YES	3.497	3.625	4.000	0.750	Plain Carbon Steel	Phosphate	WS1456
NO	3.500	3.625		0.425	Plain Carbon Steel	Phosphate	WS604
NO	3.500	3.625		0.671	Plain Carbon Steel	Phosphate	WS945
YES	3.500	3.625	4.000	0.750	Plain Carbon Steel	Phosphate	WS1575
NO	3.500	3.625		1.000	316 Stainless Steel	None	WS1023
NO	3.520	3.645		0.375	Plain Carbon Steel	Phosphate	WS1833
YES	3.562	3.688	4.000	0.765	Plain Carbon Steel	Phosphate	WS1122
NO	3.581	3.750		1.181	Plain Carbon Steel	Phosphate	WS73
NO	3.619	3.744		0.625	Plain Carbon Steel	Phosphate	WS830

E

03/03/06



Sleeve & V-Seal Sizes

All dimensions are in inch

Flanged	A	B	D	C	Material	Coating	Sleeve Part Number
	ID	OD	Flange OD	Sleeve Length			
NO	3.625	3.719		0.473	Plain Carbon Steel	Phosphate	WS932
YES	3.625	3.750	4.250	0.625	Plain Carbon Steel	Phosphate	WS910
YES	3.625	3.750	4.250	0.875	Plain Carbon Steel	Phosphate	WS627
YES	3.625	3.750	4.250	0.875	Plain Carbon Steel	Phosphate	WS2931
YES	3.625	3.750	4.250	0.875	Plain Carbon Steel	Phosphate	WS3355
YES	3.625	3.875	3.937	0.875	Plain Carbon Steel	Phosphate	WS735
NO	3.734	3.796		0.984	316 Stainless Steel	None	WS42
YES	3.813	4.938	4.947	0.620	Plain Carbon Steel	None	WS1666
NO	3.859	4.000		1.000	Cold Rolled Steel	Armaloydiamond	WS58
NO	3.859	4.000		1.188	Plain Carbon Steel	Phosphate	WS2157
NO	3.859	4.000		1.188	Plain Carbon Steel	Phosphate	WS1866
NO	3.859	4.000		1.188	Plain Carbon Steel	Phosphate	WS2062
YES	3.875	4.000	4.062	0.500	Plain Carbon Steel	Phosphate	WS1180
NO	3.875	4.063		0.810	Plain Carbon Steel	Phosphate	WS591
NO	3.884	4.000		0.750	Plain Carbon Steel	Phosphate	WS2066
YES	3.922	4.000	4.438	0.562	Plain Carbon Steel	Phosphate	WS713
NO	3.931	4.181		1.500	Plain Carbon Steel	Phosphate	WS912
NO	3.931	4.306		1.500	Plain Carbon Steel	Phosphate	WS913
NO	3.934	4.054		0.813	Plain Carbon Steel	Phosphate	WS2499
NO	3.937	4.032		0.812	Plain Carbon Steel	Phosphate	WS877
NO	3.937	4.500		0.563		None	WS5621
NO	3.974	4.125		1.575	Plain Carbon Steel	Phosphate	WS74
NO	3.993	4.118		0.687	Plain Carbon Steel	Phosphate	WS841
NO	4.000	4.125		0.540	Plain Carbon Steel	Phosphate	WS839
NO	4.000	4.125		0.750	Plain Carbon Steel	Phosphate	WS776
NO	4.000	4.125		0.750	Plain Carbon Steel	Phosphate	WS878
NO	4.000	4.125		1.625	Plain Carbon Steel	Phosphate	WS1834
YES	4.000	4.125	4.625	1.625	Plain Carbon Steel	Phosphate	WS1835
NO	4.000	4.125		1.625	Plain Carbon Steel	Phosphate	WS1836
NO	4.125	4.250		0.625	Plain Carbon Steel	Phosphate	WS1997
NO	4.187	4.375		1.250	Plain Carbon Steel	Phosphate	WS1653
NO	4.244	4.369		0.750	Plain Carbon Steel	Phosphate	WS829
YES	4.245	4.363	5.745	1.125	Plain Carbon Steel	Phosphate	WS1807
NO	4.250	4.375		0.447	Plain Carbon Steel	Phosphate	WS840
YES	4.250	4.375	4.562	0.740	Plain Carbon Steel	Phosphate	WS916
NO	4.368	4.500		1.575	Plain Carbon Steel	Phosphate	WS75
NO	4.370	4.500		1.181	Plain Carbon Steel	Phosphate	WS1747
NO	4.370	4.500		1.181	Plain Carbon Steel	Phosphate	WS2063
NO	4.375	4.500		0.515	Plain Carbon Steel	Phosphate	WS738
YES	4.375	4.500	5.000	0.865	Plain Carbon Steel	Phosphate	WS1858
YES	4.375	4.500	5.000	0.865	Plain Carbon Steel	Phosphate	WS2930
YES	4.375	4.500	4.825	0.875	Plain Carbon Steel	Phosphate	WS601
NO	4.385	4.500		0.750	Plain Carbon Steel	Phosphate	WS2065
NO	4.437	4.557		1.500	Stainless Steel 304/316	None	WS63
NO	4.438	4.563		1.375	Plain Carbon Steel	Phosphate	WS2569
NO	4.493	4.618		0.875	Plain Carbon Steel	Phosphate	WS842

03/03/06



All dimensions are in inch

Flanged	A	B	D	C	Material	Coating	Sleeve Part Number
	ID	OD	Flange OD	Sleeve Length			
NO	4.500	4.625		0.823	Plain Carbon Steel	Phosphate	WS14
NO	4.500	4.625		1.625	Stainless Steel 304/316	None	WS26
NO	4.500	4.625		2.000	Plain Carbon Steel	Phosphate	WS2357
NO	4.500	4.656		0.823	Plain Carbon Steel	Phosphate	WS632
NO	4.563	4.688		0.750	Plain Carbon Steel	Phosphate	WS1998
NO	4.594	4.750		0.750	Plain Carbon Steel	Phosphate	WS569
NO	4.625	4.747		0.710	Plain Carbon Steel	Phosphate	WS2120
NO	4.625	4.750		0.550	Plain Carbon Steel	Phosphate	WS848
NO	4.646	4.750		0.625	Plain Carbon Steel	Phosphate	WS961
NO	4.671	4.828		1.750	Plain Carbon Steel	Phosphate	WS667
NO	4.679	4.815		1.565	Plain Carbon Steel	Phosphate	WS692
NO	4.743	4.875		0.438	Plain Carbon Steel	Phosphate	WS2190
NO	4.750	4.875		0.750	Plain Carbon Steel	Phosphate	WS775
NO	4.750	4.875		0.750	Plain Carbon Steel	Phosphate	WS809
YES	4.750	4.875	5.062	0.812	Plain Carbon Steel	Phosphate	WS2230
YES	4.750	4.875	5.062	0.812	Plain Carbon Steel	Phosphate	WS2230
NO	4.766	4.953		0.556	Plain Carbon Steel	Phosphate	WS615
NO	4.813	4.968		0.484	Plain Carbon Steel	Phosphate	WS653
NO	4.862	5.012		0.985	Plain Carbon Steel	Phosphate	WS858
NO	4.875	5.000		0.500	Plain Carbon Steel	Phosphate	WS875
NO	4.875	5.000		0.500	Plain Carbon Steel	Phosphate	WS1495
NO	4.875	5.000		0.750	Plain Carbon Steel	Phosphate	WS2060
NO	4.937	5.057		1.500	Stainless Steel 304/316	None	WS62
NO	5.000	5.125		0.750	Plain Carbon Steel	Phosphate	WS2073
NO	5.000	5.125		0.750	Plain Carbon Steel	Phosphate	WS2074
NO	5.000	5.125		0.812	Plain Carbon Steel	Phosphate	WS1088
NO	5.000	5.125		0.812	Plain Carbon Steel	Phosphate	WS1673
NO	5.000	5.125		1.250	Plain Carbon Steel	Phosphate	WS1654
NO	5.000	5.125		1.750	Plain Carbon Steel	Chrome	WS2583
YES	5.000	5.125	5.625	1.750	Plain Carbon Steel	Chrome	WS2627
NO	5.069	5.188		1.250	Plain Carbon Steel	Phosphate	WS1574
NO	5.073	5.188		0.750	Plain Carbon Steel	Phosphate	WS2067
NO	5.078	5.188		1.575	Plain Carbon Steel	Phosphate	WS76
NO	5.079	5.199		1.181	Plain Carbon Steel	Phosphate	WS2161
YES	5.125	5.250	5.750	0.813	Plain Carbon Steel	Phosphate	WS2929
YES	5.125	5.250	5.750	0.813	Plain Carbon Steel	Phosphate	WS1484
NO	5.243	5.363		0.625	Plain Carbon Steel	None	WS914
NO	5.250	5.375		1.750	Plain Carbon Steel	Chrome	WS2578
NO	5.250	5.375		1.750	Plain Carbon Steel	Chrome	WS2582
YES	5.250	5.375	5.875	1.750	Plain Carbon Steel	Chrome	WS2623
NO	5.250	5.378		0.750	Plain Carbon Steel	Phosphate	WS1171
YES	5.500	5.625	6.000	0.625	Plain Carbon Steel	Phosphate	WS867
NO	5.500	5.625		0.750	Plain Carbon Steel	Phosphate	WS1412
YES	5.500	5.625	6.000	0.875	Plain Carbon Steel	Phosphate	WS2223
NO	5.500	5.625		1.750	Plain Carbon Steel	Chrome	WS2577
YES	5.500	5.625	6.125	1.750	Plain Carbon Steel	Chrome	WS2622



03/03/06



Sleeve & V-Seal Sizes

All dimensions are in inch

Flanged	A	B	D	C	Material	Coating	Sleeve Part Number
	ID	OD	Flange OD	Sleeve Length			
NO	5.625	5.750		0.980	Plain Carbon Steel	Phosphate	WS609
YES	5.734	5.875	6.377	0.750	Plain Carbon Steel	Phosphate	WS676
NO	5.750	5.875		0.740	Plain Carbon Steel	Phosphate	WS675
YES	5.866	5.984	7.087	0.630	Plain Carbon Steel	Phosphate	WS81
NO	5.866	5.991		1.181	Plain Carbon Steel	Phosphate	WS2380
NO	5.866	5.991		1.181	Plain Carbon Steel	Phosphate	WS2412
NO	5.875	6.000		0.875	Plain Carbon Steel	Phosphate	WS15
NO	5.875	6.000		1.875	Plain Carbon Steel	Phosphate	WS2149
NO	5.875	6.000		2.000	Stainless Steel 304/316	None	WS30
NO	5.937	6.062		0.750	Plain Carbon Steel	Phosphate	WS1164
NO	5.992	6.012		0.750	Plain Carbon Steel	Phosphate	WS2500
NO	5.993	6.118		0.750	Plain Carbon Steel	Phosphate	WS856
NO	6.000	6.125		0.750	Plain Carbon Steel	Phosphate	WS777
NO	6.000	6.125		0.750	Plain Carbon Steel	Phosphate	WS1411
NO	6.000	6.125		1.750	Plain Carbon Steel	Chrome	WS2581
YES	6.000	6.125	6.625	1.750	Plain Carbon Steel	Chrome	WS2626
YES	6.109	6.250	7.250	1.948	316 Stainless Steel	Phosphate	WS739
NO	6.125	6.239		1.000	Plain Carbon Steel	Phosphate	WS1433
NO	6.125	6.250		1.000	Cold Rolled Steel	None	WS39
YES	6.125	6.250	6.432	1.000	Plain Carbon Steel	Phosphate	WS999
NO	6.125	6.250		1.000	Plain Carbon Steel	Phosphate	WS2041
NO	6.125	6.250		1.000	Plain Carbon Steel	Phosphate	WS2041
NO	6.250	6.375		0.938	Plain Carbon Steel	Phosphate	WS83
NO	6.250	6.375		1.750	Plain Carbon Steel	Chrome	WS2576
YES	6.250	6.375	6.875	1.750	Plain Carbon Steel	Chrome	WS2621
NO	6.366	6.491		1.500	Cold Rolled Steel	Phosphate	WS849
NO	6.375	6.500		0.875	Plain Carbon Steel	Phosphate	WS2037
NO	6.375	6.500		1.000	316 Stainless Steel	None	WS13
YES	6.375	6.500	6.682	1.000	Plain Carbon Steel	Phosphate	WS1001
YES	6.375	6.500		1.313	Plain Carbon Steel	Phosphate	WS2683
NO	6.375	6.500		1.500	Plain Carbon Steel	Phosphate	WS1446
NO	6.485	6.673		1.250	Plain Carbon Steel	Phosphate	WS18
NO	6.500	6.625		1.750	Plain Carbon Steel	Chrome	WS2580
YES	6.500	6.625	7.125	1.750	Plain Carbon Steel	Chrome	WS2625
NO	6.625	6.750		1.000	Plain Carbon Steel	Phosphate	WS2061
NO	6.631	6.751		1.500	Stainless Steel 304/316	None	WS60
NO	6.750	6.870		1.000	Plain Carbon Steel	Phosphate	WS2090
NO	6.750	6.870		1.000	Plain Carbon Steel	Phosphate	WS2091
NO	6.750	6.875		0.625	Plain Carbon Steel	Phosphate	WS1822
NO	6.750	6.875		0.625	Stainless Steel 301/304	None	WS1824
NO	6.750	6.875		1.000	Plain Carbon Steel	Phosphate	WS2087
NO	6.750	6.875		1.000	304 Stainless Steel	None	WS2092
NO	6.750	6.875		1.000	304 Stainless Steel	None	WS2093
NO	6.750	6.875		1.750	Plain Carbon Steel	Chrome	WS2575
YES	6.750	6.875	7.375	1.750	Plain Carbon Steel	Chrome	WS2620
NO	6.875	7.000		0.750	Plain Carbon Steel	Phosphate	WS1165

03/03/06



All dimensions are in inch

Flanged	A	B	D	C	Material	Coating	Sleeve Part Number
	ID	OD	Flange OD	Sleeve Length			
NO	6.875	7.000		0.750	Plain Carbon Steel	Phosphate	WS1178
YES	6.875	7.000	7.375	0.750	Plain Carbon Steel	Phosphate	WS1492
NO	6.875	7.000		0.750	304 Stainless Steel	None	WS1677
NO	6.875	7.000		0.750	Plain Carbon Steel	Phosphate	WS2125
YES	6.875	7.000	7.187	1.000	Plain Carbon Steel	Phosphate	WS2099
NO	7.000	7.062		1.500	Plain Carbon Steel	Phosphate	WS1896
NO	7.000	7.062		1.500	Plain Carbon Steel	Chrome	WS1897
NO	7.000	7.062		1.500	304 Stainless Steel	None	WS1898
NO	7.000	7.125		1.500	Plain Carbon Steel	Phosphate	WS1892
NO	7.125	7.250		0.750	Plain Carbon Steel	Phosphate	WS1548
NO	7.131	7.251		1.500	Stainless Steel 304/316	None	WS61
NO	7.240	7.360		1.000	Plain Carbon Steel	Phosphate	WS860
NO	7.250	7.375		1.000	Plain Carbon Steel	Phosphate	WS1942
NO	7.258	7.500		0.687	Plain Carbon Steel	Phosphate	WS1468
NO	7.375	7.500		0.750	Plain Carbon Steel	Phosphate	WS1181
NO	7.375	7.500		0.875	Plain Carbon Steel	Phosphate	WS1170
NO	7.375	7.500		1.000	Plain Carbon Steel	Phosphate	WS774
NO	7.375	7.500		1.000	Plain Carbon Steel	Phosphate	WS1801
YES	7.375	7.500	7.875	1.000	Plain Carbon Steel	Phosphate	WS1863
NO	7.496	7.618		0.640	Plain Carbon Steel	Phosphate	WS1098
NO	7.500	7.625		0.625	Plain Carbon Steel	Phosphate	WS1053
NO	7.500	7.625		0.750	Plain Carbon Steel	Phosphate	WS1080
NO	7.500	7.625		1.750	Plain Carbon Steel	Chrome	WS2579
YES	7.500	7.625	8.125	1.750	Plain Carbon Steel	Chrome	WS2624
NO	7.500	7.875		0.250	Plain Carbon Steel	Phosphate	WS79
NO	7.515	7.875		2.250	Plain Carbon Steel	Phosphate	WS2
YES	7.609	7.750	8.125	0.968	Plain Carbon Steel		WS883
NO	7.615	7.735		0.838	Plain Carbon Steel	Phosphate	WS882
NO	7.625	7.750		0.510	Plain Carbon Steel	Phosphate	WS1570
NO	7.625	7.750		0.625	Plain Carbon Steel	Phosphate	WS1449
NO	7.625	7.750		1.250	Plain Carbon Steel	Phosphate	WS1032
NO	7.750	7.875		0.625	Plain Carbon Steel	Phosphate	WS1823
NO	7.750	7.875		0.625	Stainless Steel 301/304	None	WS1825
NO	7.750	7.875		1.750	Plain Carbon Steel	Chrome	WS2574
YES	7.750	7.875	8.375	1.750	Plain Carbon Steel	Chrome	WS2619
NO	7.875	8.000		0.750	Plain Carbon Steel	Phosphate	WS983
NO	7.990	8.110		0.875	Plain Carbon Steel	Phosphate	WS2501
YES	7.991	8.109	8.302	1.375	Plain Carbon Steel	Phosphate	WS897
NO	8.000	8.125		0.750	Plain Carbon Steel	Phosphate	WS781
NO	8.000	8.125		1.000	Plain Carbon Steel	Phosphate	WS1236
YES	8.000	8.125	8.500	1.000	Plain Carbon Steel	Phosphate	WS1814
NO	8.125	8.250		1.000	Plain Carbon Steel	Phosphate	WS1549
YES	8.125	8.250	11.750	1.206	Plain Carbon Steel	Phosphate	WS1280
NO	8.125	8.250		1.469	Plain Carbon Steel	Phosphate	WS2127
NO	8.125	8.250		1.500	Plain Carbon Steel	Phosphate	WS1780
NO	8.125	8.250		1.500	Plain Carbon Steel	Phosphate	WS1957



03/03/06



Sleeve & V-Seal Sizes

All dimensions are in inch

Flanged	A	B	D	C	Material	Coating	Sleeve Part Number
	ID	OD	Flange OD	Sleeve Length			
NO	8.183	8.500		1.188	Plain Carbon Steel	Phosphate	WS2238
NO	8.250	8.375		0.750	Plain Carbon Steel	Phosphate	WS782
NO	8.250	8.375		1.750	Plain Carbon Steel	Phosphate	WS1954
NO	8.250	8.500		0.625	Cold Rolled Steel	Phosphate	WS40
NO	8.250	8.500		1.188	Plain Carbon Steel	Phosphate	WS1864
NO	8.250	8.500		1.188	Plain Carbon Steel	Phosphate	WS1864
NO	8.375	8.500		0.750	304 Stainless Steel	None	WS2871
NO	8.490	8.610		0.562	Plain Carbon Steel	Phosphate	WS865
NO	8.490	8.610		0.562	Plain Carbon Steel	Phosphate	WS880
NO	8.500	8.625		0.625	Plain Carbon Steel	Phosphate	WS975
NO	8.500	8.625		1.250	Plain Carbon Steel	Phosphate	WS2363
NO	8.508	8.628		1.250	Plain Carbon Steel	Phosphate	WS2530
NO	8.508	8.628		1.500	Plain Carbon Steel	Phosphate	WS2529
NO	8.644	9.094		3.500	Plain Carbon Steel	Phosphate	WS78
NO	8.656	9.094		2.250	Plain Carbon Steel	Phosphate	WS1
NO	8.750	8.875		1.000	Plain Carbon Steel	Phosphate	WS24
NO	8.750	8.875		1.750	Plain Carbon Steel	Chrome	WS2573
YES	8.750	8.875	9.375	1.750	Plain Carbon Steel	Chrome	WS2618
NO	8.774	9.750		1.937	Plain Carbon Steel	Phosphate	WS2388
NO	8.875	9.000		0.500	Plain Carbon Steel	Phosphate	WS2413
NO	8.875	9.000		0.687	Plain Carbon Steel	Phosphate	WS2936
NO	8.875	9.000		0.750	Plain Carbon Steel	Phosphate	WS783
NO	8.875	9.000		0.750	Plain Carbon Steel	Phosphate	WS1172
NO	9.000	9.125		0.438	Plain Carbon Steel	Phosphate	WS2687
NO	9.000	9.125		0.500	Plain Carbon Steel	Phosphate	WS2701
YES	9.000	9.125	9.307	1.000	Plain Carbon Steel	Phosphate	WS1185
NO	9.000	9.125		1.000	Plain Carbon Steel	Phosphate	WS1542
YES	9.000	9.125	10.000	1.000	Plain Carbon Steel	Phosphate	WS1777
NO	9.125	9.250		0.625	Plain Carbon Steel	Phosphate	WS34
NO	9.125	9.250		0.750	Plain Carbon Steel	Phosphate	WS784
NO	9.125	9.250		1.500	304 Stainless Steel	Phosphate	WS50
NO	9.125	9.313		2.250	Plain Carbon Steel	Phosphate	WS17
YES	9.241	9.361	9.750	0.875	Plain Carbon Steel	Phosphate	WS1018
YES	9.250	9.375	9.750	0.875	Plain Carbon Steel	Phosphate	WS1494
NO	9.250	9.375		1.125	Plain Carbon Steel	Phosphate	WS2369
NO	9.375	9.500		0.688	Plain Carbon Steel	Phosphate	WS1273
YES	9.375	9.500	9.682	0.750	Plain Carbon Steel	Phosphate	WS1223
YES	9.375	9.500	9.682	0.750	Plain Carbon Steel	Phosphate	WS1486
NO	9.375	9.500		0.750	Plain Carbon Steel	Phosphate	WS1939
NO	9.375	9.500		1.000	Plain Carbon Steel	Phosphate	WS1177
NO	9.375	9.500		1.625	Cold Rolled Steel	None	WS41
NO	9.375	9.500		1.625	Plain Carbon Steel	Phosphate	WS1429
NO	9.375	9.500		1.625	Plain Carbon Steel	Phosphate	WS1429
NO	9.447	9.567		1.250	Plain Carbon Steel	Phosphate	WS2532
NO	9.447	9.567		1.500	Plain Carbon Steel	Phosphate	WS2531
NO	9.500	9.625		1.000	Plain Carbon Steel	Phosphate	WS2416

03/03/06



All dimensions are in inch

Flanged	A	B	D	C	Material	Coating	Sleeve Part Number
	ID	OD	Flange OD	Sleeve Length			
NO	9.615	9.735		1.000	Plain Carbon Steel	Phosphate	WS861
NO	9.625	10.000		0.813	Plain Carbon Steel	Phosphate	WS2439
NO	9.750	9.875		0.750	Plain Carbon Steel	Phosphate	WS785
NO	9.750	9.875		1.000	Plain Carbon Steel	Phosphate	WS2236
YES	9.750	9.875	10.875	1.000	Plain Carbon Steel	Phosphate	WS2237
NO	9.750	9.875		2.500	Plain Carbon Steel	Phosphate	WS2086
NO	9.750	10.000		1.187	Plain Carbon Steel	Phosphate	WS2181
NO	9.875	10.000		0.750	Plain Carbon Steel	Phosphate	WS1415
NO	9.875	10.000		0.750	Plain Carbon Steel	Phosphate	WS1430
NO	9.875	10.000		0.750	Plain Carbon Steel	Phosphate	WS1534
NO	9.875	10.000		1.000	Plain Carbon Steel	Phosphate	WS1066
YES	9.875	10.000	10.500	1.000	Plain Carbon Steel	Phosphate	WS2874
NO	9.875	10.000		1.625	Plain Carbon Steel	Phosphate	WS66
NO	9.990	10.110		0.875	Plain Carbon Steel	Phosphate	WS2502
NO	10.000	10.125		2.250	Plain Carbon Steel	Chrome	WS2572
YES	10.000	10.125	10.625	2.250	Plain Carbon Steel	Chrome	WS2617
NO	10.000	10.250		2.438	Plain Carbon Steel	Phosphate	WS2042
YES	10.500	10.625	11.000	1.000	Plain Carbon Steel	Phosphate	WS1158
YES	10.500	10.625	11.000	1.000	Plain Carbon Steel	Phosphate	WS1289
YES	10.500	10.625	11.000	1.000	Plain Carbon Steel	Phosphate	WS1447
YES	10.500	10.625	11.000	1.000	304 Stainless Steel	None	WS2944
NO	10.500	10.750		2.500	Plain Carbon Steel	Phosphate	WS2275
NO	10.500	11.000		1.000	Plain Carbon Steel	Phosphate	WS2802
NO	10.500	11.500		1.000	Plain Carbon Steel	Phosphate	WS3031
NO	10.625	10.750		1.500	Plain Carbon Steel	Phosphate	WS2281
NO	10.748	10.875		2.500	Plain Carbon Steel	Phosphate	WS2291
NO	10.750	10.875		3.000	Plain Carbon Steel	Phosphate	WS2349
NO	10.875	11.000		0.750	Plain Carbon Steel	Phosphate	WS1410
NO	11.000	11.125		0.750	Plain Carbon Steel	Phosphate	WS786
NO	11.000	11.125		0.750	Plain Carbon Steel	Phosphate	WS1081
NO	11.000	11.125		2.250	Plain Carbon Steel	Chrome	WS2571
YES	11.000	11.125	11.625	2.250	Plain Carbon Steel	Chrome	WS2616
NO	11.250	11.375		2.250	Plain Carbon Steel	Chrome	WS2570
YES	11.250	11.375	11.875	2.250	Plain Carbon Steel	Chrome	WS2615
NO	11.500	11.610		2.375	Plain Carbon Steel	Phosphate	WS5905
NO	11.500	11.625		1.000	Plain Carbon Steel	Phosphate	WS2417
NO	11.603	11.720		0.533	Plain Carbon Steel	Phosphate	WS1688
NO	11.990	12.109		0.875	Plain Carbon Steel	Phosphate	WS2503
NO	12.000	12.062		2.000	Plain Carbon Steel	Phosphate	WS1899
NO	12.000	12.062		2.000	Plain Carbon Steel	Chrome	WS1900
NO	12.000	12.062		2.000	304 Stainless Steel	None	WS1901
NO	12.000	12.125		2.000	Plain Carbon Steel	Phosphate	WS1893
NO	12.062	12.375		1.500	Plain Carbon Steel	Phosphate	WS1865
NO	12.125	12.250		0.750	Plain Carbon Steel	Phosphate	WS863
NO	12.219	12.375		1.500	Plain Carbon Steel	Phosphate	WS1493
NO	12.500	12.625		0.750	Plain Carbon Steel	Phosphate	WS2133



03/03/06



Sleeve & V-Seal Sizes

All dimensions are in inch

Flanged	A	B	D	C	Material	Coating	Sleeve Part Number
	ID	OD	Flange OD	Sleeve Length			
NO	12.500	12.625		2.500	Plain Carbon Steel	Phosphate	WS2290
NO	12.500	12.625		2.750	Plain Carbon Steel	Phosphate	WS2348
NO	12.875	13.000		0.938	Plain Carbon Steel	Phosphate	WS1491
NO	12.891	13.000		0.938	Plain Carbon Steel	Phosphate	WS3113
NO	13.000	13.125		0.750	Plain Carbon Steel	Phosphate	WS981
NO	13.125	13.250		0.750	Plain Carbon Steel	Phosphate	WS1950
NO	13.125	13.250		0.750	Plain Carbon Steel	Phosphate	WS2160
NO	13.391	13.516		2.000	Plain Carbon Steel	Phosphate	WS1772
YES	13.500	13.625	14.000	1.000	Plain Carbon Steel	Phosphate	WS1457
NO	13.750	14.000		1.378	Cold Rolled Steel	Armaloydiamond	WS46
NO	13.875	14.000		0.750	Plain Carbon Steel	Phosphate	WS2214
NO	13.875	14.000		1.000	Plain Carbon Steel	Phosphate	WS2340
NO	13.990	14.109		1.000	Plain Carbon Steel	Phosphate	WS2504
NO	14.000	14.125		0.750	Plain Carbon Steel	Phosphate	WS982
NO	14.000	14.125		1.000	Plain Carbon Steel	Phosphate	WS2338
NO	14.025	14.150		0.750	Plain Carbon Steel	Phosphate	WS2215
NO	14.156	14.281		0.750	Plain Carbon Steel	Phosphate	WS2235
NO	14.425	14.550		0.625	Plain Carbon Steel	Phosphate	WS838
NO	14.875	15.000		0.500	Plain Carbon Steel	Phosphate	WS2959
NO	14.875	15.000		0.625	Plain Carbon Steel	Phosphate	WS2280
NO	14.875	15.000		0.750	Plain Carbon Steel	Phosphate	WS20
NO	14.875	15.000		1.125	Plain Carbon Steel	Phosphate	WS2344
NO	15.741	15.891		1.125	Plain Carbon Steel	Phosphate	WS72
NO	15.990	16.110		1.125	Plain Carbon Steel	Phosphate	WS2505
NO	16.062	16.250		1.325	1008-1030 Steel	None	WS37
NO	16.387	16.500		1.000	Plain Carbon Steel	Phosphate	WS2129
NO	16.500	16.625		1.000	Plain Carbon Steel	Phosphate	WS2418
NO	16.625	16.750		1.000	316 Stainless Steel	None	WS2812
NO	17.875	18.000		1.250	Plain Carbon Steel	Phosphate	WS2828
NO	17.990	18.110		1.250	Plain Carbon Steel	Phosphate	WS2506
NO	17.990	18.110		3.000	Plain Carbon Steel	Chrome	WS2797
NO	18.000	18.120		0.750	Plain Carbon Steel	Phosphate	WS2345
NO	18.875	19.000		1.000	Plain Carbon Steel	Phosphate	WS2341
NO	19.000	19.125		1.000	Plain Carbon Steel	Phosphate	WS2339
NO	20.000	20.125		0.750	Plain Carbon Steel	Phosphate	WS2724
NO	20.990	21.109		1.250	Plain Carbon Steel	Phosphate	WS2507
NO	20.990	21.124		3.000	Plain Carbon Steel	Chrome	WS2669
NO	22.047	22.172		0.874	Plain Carbon Steel	Phosphate	WS19
NO	22.047	22.172		0.874	Plain Carbon Steel	Phosphate	WS19
NO	22.875	23.000		1.250	Plain Carbon Steel	Phosphate	WS2397
NO	23.375	23.500		1.000	Plain Carbon Steel	Phosphate	WS21
NO	23.425	23.625		0.984	1008-1030 Steel	None	WS38
NO	23.990	24.110		1.250	Plain Carbon Steel	Phosphate	WS2508
NO	23.990	24.124		3.000	Plain Carbon Steel	Chrome	WS2668
NO	25.990	26.109		1.500	Plain Carbon Steel	Phosphate	WS2509
NO	25.990	26.124		3.000	Plain Carbon Steel	Chrome	WS2666

03/03/06



All dimensions are in inch

Flanged	A	B	D	C	Material	Coating	Sleeve Part Number
	ID	OD	Flange OD	Sleeve Length			
NO	25.990	26.125		3.000	Plain Carbon Steel	Chrome	WS2561
NO	26.053	26.178		1.062	Plain Carbon Steel	Chrome	WS2550
NO	26.421	26.546		1.062	Plain Carbon Steel	Chrome	WS2551
NO	26.875	27.000		1.000	Plain Carbon Steel	Phosphate	WS2387
NO	29.998	30.132		3.000	Plain Carbon Steel	Chrome	WS2667
NO	30.000	30.125		1.500	Plain Carbon Steel	Phosphate	WS2510
NO	30.989	31.114		0.750	Plain Carbon Steel	Phosphate	WS2386
NO	31.998	32.132		3.000	Plain Carbon Steel	Chrome	WS2670
NO	32.000	32.125		1.500	Plain Carbon Steel	Phosphate	WS2511



03/03/06



Sleeve & V-Seal Sizes

Gland Dimensions — V-Seal A Profile

All alphabetic dimensions are in inch

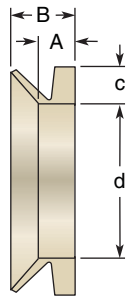

Profile Dimensions

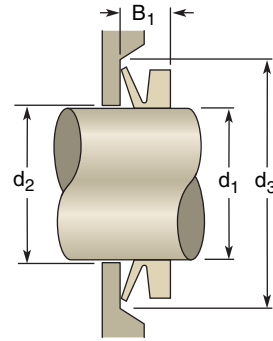

Assembly Dimensions

For Shaft Diameter d ₁	Inside Diameter d	Height c	Dim. A	Free Width B	Max. d ₂ = d ₁ +	Min. d ₃ = d ₁ +	Fitted Width B ₁	Metric Shaft Range	V-Seal Part Number
0.11 – 0.14	0.10	0.06	0.08	0.12	0.04	0.16	0.10 ± .012	2.8 – 3.6	V-3A NBR
0.14 – 0.18	0.13	0.08	0.09	0.15	0.04	0.25	0.12 ± .016	3.6 – 4.6	V-4A NBR
0.18 – 0.21	0.16	0.08	0.09	0.15	0.04	0.25	0.12 ± .016	4.6 – 5.3	V-5A NBR
0.21 – 0.26	0.20	0.08	0.09	0.15	0.04	0.25	0.12 ± .016	5.3 – 6.6	V-6A NBR
0.26 – 0.31	0.24	0.08	0.09	0.15	0.04	0.25	0.12 ± .016	6.6 – 7.9	V-7A NBR
0.31 – 0.37	0.28	0.08	0.09	0.15	0.04	0.35	0.12 ± .016	7.9 – 9.4	V-8A NBR
0.37 – 0.45	0.35	0.12	0.13	0.22	0.08	0.35	0.18 ± .02	9.4 – 11.4	V-10A NBR
0.45 – 0.49	0.41	0.12	0.13	0.22	0.08	0.35	0.18 ± .02	11.4 – 12.4	V-12A NBR
0.49 – 0.53	0.46	0.12	0.13	0.22	0.08	0.35	0.18 ± .02	12.4 – 13.5	V-13A NBR
0.53 – 0.61	0.49	0.12	0.13	0.22	0.08	0.35	0.18 ± .02	13.5 – 15.5	V-14A NBR
0.61 – 0.69	0.55	0.12	0.13	0.22	0.08	0.35	0.18 ± .02	15.5 – 17.5	V-16A NBR
0.69 – 0.75	0.63	0.12	0.13	0.22	0.08	0.35	0.18 ± .02	17.5 – 19.1	V-18A NBR
0.75 – 0.83	0.71	0.16	0.18	0.30	0.08	0.45	0.24 ± .03	19.1 – 21.1	V-20A NBR
0.83 – 0.95	0.79	0.16	0.18	0.30	0.08	0.45	0.24 ± .03	21.1 – 24.1	V-22A NBR
0.95 – 1.07	0.87	0.16	0.18	0.30	0.08	0.45	0.24 ± .03	24.1 – 27.2	V-25A NBR
1.07 – 1.14	0.98	0.16	0.18	0.30	0.08	0.45	0.24 ± .03	27.2 – 29.0	V-28A NBR
1.14 – 1.22	1.06	0.16	0.18	0.30	0.12	0.45	0.24 ± .03	29.0 – 31.0	V-30A NBR
1.22 – 1.30	1.14	0.16	0.18	0.30	0.12	0.45	0.24 ± .03	31.0 – 33.0	V-32A NBR
1.30 – 1.42	1.22	0.16	0.18	0.30	0.12	0.45	0.24 ± .03	33.0 – 36.1	V-35A NBR
1.42 – 1.50	1.34	0.16	0.18	0.30	0.12	0.60	0.24 ± .03	36.1 – 38.1	V-38A NBR
1.50 – 1.70	1.42	0.20	0.21	0.35	0.12	0.60	0.28 ± .04	38.1 – 43.2	V-40A NBR
1.70 – 1.89	1.57	0.20	0.21	0.35	0.12	0.60	0.28 ± .04	43.2 – 48.0	V-45A NBR
1.89 – 2.09	1.77	0.20	0.21	0.35	0.12	0.60	0.28 ± .04	48.0 – 53.1	V-50A NBR
2.09 – 2.29	1.93	0.20	0.21	0.35	0.12	0.60	0.28 ± .04	53.1 – 58.2	V-55A NBR
2.29 – 2.48	2.13	0.20	0.21	0.35	0.12	0.60	0.28 ± .04	58.2 – 63.0	V-60A NBR
2.48 – 2.68	2.28	0.20	0.21	0.35	0.12	0.60	0.28 ± .04	63.0 – 68.1	V-65A NBR
2.68 – 2.88	2.48	0.24	0.26	0.43	0.16	0.70	0.35 ± .05	68.1 – 73.2	V-70A NBR
2.88 – 3.07	2.64	0.24	0.26	0.43	0.16	0.70	0.35 ± .05	73.2 – 78.0	V-75A NBR
3.07 – 3.27	2.83	0.24	0.26	0.43	0.16	0.70	0.35 ± .05	78.0 – 83.1	V-80A NBR
3.27 – 3.47	2.99	0.24	0.26	0.43	0.16	0.70	0.35 ± .05	83.1 – 88.1	V-85A NBR
3.47 – 3.66	3.19	0.24	0.26	0.43	0.16	0.70	0.35 ± .05	88.1 – 93.0	V-90A NBR
3.66 – 3.86	3.35	0.24	0.26	0.43	0.16	0.70	0.35 ± .05	93.0 – 98.0	V-95A NBR
3.86 – 4.14	3.54	0.24	0.26	0.43	0.16	0.70	0.35 ± .05	98.0 – 105.2	V-100A NBR
4.14 – 4.53	3.90	0.28	0.31	0.50	0.16	0.80	0.41 ± .06	105.2 – 115.1	V-110A NBR
4.53 – 4.92	4.25	0.28	0.31	0.50	0.16	0.80	0.41 ± .06	115.1 – 125.0	V-120A NBR
4.92 – 5.32	4.61	0.28	0.31	0.50	0.16	0.80	0.41 ± .06	125.0 – 135.1	V-130A NBR

03/03/06



All alphabetic dimensions are in inch

For Shaft Diameter d_1	Inside Diameter d	Height c	Dim. A	Free Width B	Max. $d_2 = d_1 +$	Min. $d_3 = d_1 +$	Fitted Width B_1	Metric Shaft Range	V-Seal Part Number
5.32 – 5.71	4.96	0.28	0.31	0.50	0.16	0.80	0.41 ± .06	135.1 – 145.0	V-140A NBR
5.71 – 6.10	5.31	0.28	0.31	0.50	0.16	0.80	0.41 ± .06	145.0 – 154.9	V-150A NBR
6.10 – 6.50	5.67	0.32	0.35	0.57	0.20	0.95	0.47 ± .07	154.9 – 165.1	V-160A NBR
6.50 – 6.89	6.02	0.32	0.35	0.57	0.20	0.95	0.47 ± .07	165.1 – 175.0	V-170A NBR
6.89 – 7.29	6.38	0.32	0.35	0.57	0.20	0.95	0.47 ± .07	175.0 – 185.2	V-180A NBR
7.29 – 7.68	6.73	0.32	0.35	0.57	0.20	0.95	0.47 ± .07	185.2 – 195.1	V-190A NBR
7.68 – 8.27	7.09	0.32	0.35	0.57	0.20	0.95	0.47 ± .07	195.1 – 210.1	V-199A NBR
7.48 – 8.27	7.09	0.59	0.56	0.98	0.39	1.75	0.79 ± .16	190.1 – 210.1	V-200A NBR
8.27 – 9.25	7.80	0.59	0.56	0.98	0.39	1.75	0.79 ± .16	210.1 – 235.0	V-220A NBR
9.25 – 10.43	8.86	0.59	0.56	0.98	0.39	1.75	0.79 ± .16	235.0 – 264.9	V-250A NBR
10.43 – 11.42	9.72	0.59	0.56	0.98	0.39	1.75	0.79 ± .16	264.9 – 290.1	V-275A NBR
11.42 – 12.20	10.63	0.59	0.56	0.98	0.39	1.75	0.79 ± .16	290.1 – 309.9	V-300A NBR
12.20 – 13.19	11.50	0.59	0.56	0.98	0.39	1.75	0.79 ± .16	309.0 – 335.0	V-325A NBR
13.19 – 14.37	12.40	0.59	0.56	0.98	0.39	1.75	0.79 ± .16	335.0 – 365.0	V-350A NBR
14.37 – 15.35	13.27	0.59	0.56	0.98	0.39	1.75	0.79 ± .16	365.0 – 389.9	V-375A NBR
15.35 – 16.93	14.17	0.59	0.56	0.98	0.39	1.75	0.79 ± .16	389.9 – 430.0	V-400A NBR
16.93 – 18.90	15.94	0.59	0.56	0.98	0.39	1.75	0.79 ± .16	430.0 – 480.1	V-450A NBR
18.90 – 20.87	17.72	0.59	0.56	0.98	0.39	1.75	0.79 ± .16	480.1 – 530.1	V-500A NBR
20.87 – 22.83	19.49	0.59	0.56	0.98	0.39	1.75	0.79 ± .16	530.1 – 579.9	V-550A NBR
22.83 – 24.80	21.26	0.59	0.56	0.98	0.39	1.75	0.79 ± .16	579.9 – 629.9	V-600A NBR
24.80 – 26.18	23.62	0.59	0.56	0.98	0.39	1.75	0.79 ± .16	629.9 – 665.0	V-650A NBR
26.18 – 27.76	24.80	0.59	0.56	0.98	0.39	1.75	0.79 ± .16	665.0 – 705.1	V-700A NBR
27.76 – 29.33	26.38	0.59	0.56	0.98	0.39	1.75	0.79 ± .16	705.1 – 745.0	V-725A NBR
29.33 – 30.91	27.76	0.59	0.56	0.98	0.39	1.75	0.79 ± .16	745.0 – 785.1	V-750A NBR
30.91 – 32.68	29.33	0.59	0.56	0.98	0.39	1.75	0.79 ± .16	785.1 – 830.1	V-800A NBR
32.68 – 34.45	30.91	0.59	0.56	0.98	0.39	1.75	0.79 ± .16	830.1 – 875.0	V-850A NBR
34.45 – 36.22	32.48	0.59	0.56	0.98	0.39	1.75	0.79 ± .16	875.0 – 920.0	V-900A NBR
36.22 – 37.99	34.06	0.59	0.56	0.98	0.39	1.75	0.79 ± .16	920.0 – 964.9	V-950A NBR
37.99 – 39.96	35.83	0.59	0.56	0.98	0.39	1.75	0.79 ± .16	964.9 – 1015.0	V-1000A NBR
39.96 – 41.93	37.60	0.59	0.56	0.98	0.39	1.75	0.79 ± .16	1015.0 – 1065.0	V-1050A NBR
41.93 – 43.90	39.37	0.59	0.56	0.98	0.39	1.75	0.79 ± .16	1065.0 – 1115.1	V-1100A NBR
43.90 – 45.87	41.14	0.59	0.56	0.98	0.39	1.75	0.79 ± .16	1115.1 – 1165.1	V-1150A NBR
45.87 – 47.84	42.91	0.59	0.56	0.98	0.39	1.75	0.79 ± .16	1165.1 – 1215.1	V-1200A NBR
47.84 – 50.00	44.69	0.59	0.56	0.98	0.39	1.75	0.79 ± .16	1215.1 – 1270.0	V-1250A NBR
50.00 – 51.97	46.46	0.59	0.56	0.98	0.39	1.75	0.79 ± .16	1270.0 – 1320.0	V-1300A NBR
51.97 – 53.94	48.23	0.59	0.56	0.98	0.39	1.75	0.79 ± .16	1320.0 – 1370.1	V-1350A NBR
53.94 – 55.91	50.00	0.59	0.56	0.98	0.39	1.75	0.79 ± .16	1370.1 – 1420.1	V-1400A NBR
55.91 – 57.87	51.77	0.59	0.56	0.98	0.39	1.75	0.79 ± .16	1420.1 – 1469.9	V-1450A NBR
57.87 – 59.84	53.54	0.59	0.56	0.98	0.39	1.75	0.79 ± .16	1469.9 – 1519.9	V-1500A NBR
59.84 – 61.81	55.32	0.59	0.56	0.98	0.39	1.75	0.79 ± .16	1519.9 – 1570.0	V-1550A NBR
61.81 – 63.78	57.09	0.59	0.56	0.98	0.39	1.75	0.79 ± .16	1570.0 – 1620.0	V-1600A NBR
63.78 – 65.75	58.86	0.59	0.56	0.98	0.39	1.75	0.79 ± .16	1620.0 – 1670.1	V-1650A NBR
65.75 – 67.72	60.63	0.59	0.56	0.98	0.39	1.75	0.79 ± .16	1670.1 – 1720.1	V-1700A NBR
67.72 – 69.69	62.40	0.59	0.56	0.98	0.39	1.75	0.79 ± .16	1720.1 – 1770.1	V-1750A NBR
69.69 – 71.65	64.17	0.59	0.56	0.98	0.39	1.75	0.79 ± .16	1770.1 – 1819.9	V-1800A NBR
71.65 – 73.62	65.95	0.59	0.56	0.98	0.39	1.75	0.79 ± .16	1819.9 – 1869.1	V-1850A NBR
73.62 – 75.59	67.72	0.59	0.56	0.98	0.39	1.75	0.79 ± .16	1869.9 – 1920.0	V-1900A NBR
75.59 – 77.56	69.49	0.59	0.56	0.98	0.39	1.75	0.79 ± .16	1920.0 – 1970.0	V-1950A NBR
77.56 – 79.53	71.26	0.59	0.56	0.98	0.39	1.75	0.79 ± .16	1970.0 – 2020.1	V-2000A NBR



03/03/06



Sleeve & V-Seal Sizes

Gland Dimensions — V-Seal S Profile

All alphabetic dimensions are in inch

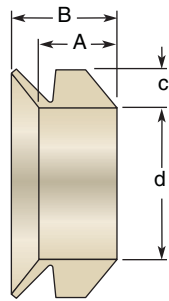

Profile Dimensions

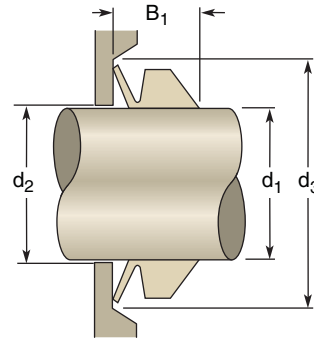

Assembly Dimensions

For Shaft Diameter d ₁	Inside Diameter d	Height c	Dim. A	Free Width B	Max. d ₂ = d ₁ +	Min. d ₃ = d ₁ +	Fitted Width B ₁	Metric Shaft Range	V-Seal Part Number
0.18 – 0.21	0.16	0.08	0.15	0.21	0.04	0.25	0.18 ± .016	4.6 – 5.3	V-5S NBR
0.21 – 0.26	0.20	0.08	0.15	0.21	0.04	0.25	0.18 ± .016	5.3 – 6.6	V-6S NBR
0.26 – 0.31	0.24	0.08	0.15	0.21	0.04	0.25	0.18 ± .016	6.6 – 7.9	V-7S NBR
0.31 – 0.37	0.28	0.08	0.15	0.21	0.04	0.25	0.18 ± .016	7.9 – 9.4	V-8S NBR
0.37 – 0.45	0.35	0.12	0.22	0.30	0.08	0.35	0.26 ± .020	9.4 – 11.4	V-10S NBR
0.45 – 0.53	0.41	0.12	0.22	0.30	0.08	0.35	0.26 ± .020	11.4 – 13.5	V-12S NBR
0.53 – 0.61	0.49	0.12	0.22	0.30	0.08	0.35	0.26 ± .020	13.5 – 17.5	V-14S NBR
0.69 – 0.77	0.63	0.12	0.22	0.30	0.08	0.35	0.26 ± .020	17.5 – 19.6	V-18S NBR
0.77 – 0.83	0.71	0.16	0.31	0.41	0.08	0.45	0.35 ± .030	19.6 – 21.1	V-20S NBR
0.83 – 0.95	0.79	0.16	0.31	0.41	0.08	0.45	0.35 ± .030	21.1 – 24.1	V-22S NBR
0.95 – 1.07	0.87	0.16	0.31	0.41	0.08	0.45	0.35 ± .030	24.1 – 27.1	V-25S NBR
1.07 – 1.14	0.98	0.16	0.31	0.41	0.12	0.45	0.35 ± .030	27.1 – 29.1	V-28S NBR
1.14 – 1.22	1.06	0.16	0.31	0.41	0.12	0.45	0.35 ± .030	29.1 – 31.1	V-30S NBR
1.22 – 1.30	1.14	0.16	0.31	0.41	0.12	0.45	0.35 ± .030	31.1 – 33.1	V-32S NBR
1.30 – 1.42	1.22	0.16	0.31	0.41	0.12	0.45	0.35 ± .030	33.1 – 36.1	V-35S NBR
1.42 – 1.50	1.34	0.16	0.31	0.41	0.12	0.45	0.35 ± .030	36.1 – 38.1	V-38S NBR
1.50 – 1.70	1.42	0.20	0.37	0.51	0.12	0.60	0.43 ± .040	38.1 – 43.2	V-40S NBR
1.70 – 1.89	1.57	0.20	0.37	0.51	0.12	0.60	0.43 ± .040	43.2 – 48.1	V-45S NBR
1.89 – 2.09	1.77	0.20	0.37	0.51	0.12	0.60	0.43 ± .040	48.1 – 53.1	V-50S NBR
2.09 – 2.29	1.93	0.20	0.37	0.51	0.12	0.60	0.43 ± .040	53.1 – 58.2	V-55S NBR
2.29 – 2.48	2.13	0.20	0.37	0.51	0.12	0.60	0.43 ± .040	58.2 – 63.1	V-60S NBR
2.48 – 2.68	2.28	0.20	0.37	0.51	0.12	0.60	0.43 ± .040	63.1 – 68.1	V-65S NBR
2.68 – 2.88	2.48	0.24	0.44	0.61	0.16	0.70	0.53 ± .050	68.1 – 73.2	V-70S NBR
2.88 – 3.07	2.64	0.24	0.44	0.61	0.16	0.70	0.53 ± .050	73.2 – 78.1	V-75S NBR
3.07 – 3.27	2.83	0.24	0.44	0.61	0.16	0.70	0.53 ± .050	78.1 – 83.1	V-80S NBR
3.27 – 3.47	2.94	0.24	0.44	0.61	0.16	0.70	0.53 ± .050	83.1 – 88.1	V-85S NBR
3.47 – 3.66	3.19	0.24	0.44	0.61	0.16	0.70	0.53 ± .050	88.1 – 93.1	V-90S NBR
3.66 – 3.86	3.35	0.24	0.44	0.61	0.16	0.70	0.53 ± .050	93.1 – 98.1	V-95S NBR
3.86 – 4.14	3.54	0.24	0.44	0.61	0.16	0.70	0.53 ± .050	98.1 – 105.2	V-100S NBR
4.14 – 4.53	3.90	0.28	0.52	0.71	0.16	0.80	0.61 ± .060	105.2 – 115.1	V-110S NBR
4.53 – 4.92	4.25	0.28	0.52	0.71	0.16	0.80	0.61 ± .060	115.1 – 125.1	V-120S NBR
4.92 – 5.32	4.61	0.28	0.52	0.71	0.16	0.80	0.61 ± .060	125.1 – 135.1	V-130S NBR
5.32 – 5.71	4.96	0.28	0.52	0.71	0.16	0.80	0.61 ± .060	135.1 – 145.1	V-140S NBR
5.71 – 6.10	5.31	0.28	0.52	0.71	0.16	0.80	0.61 ± .060	145.1 – 154.9	V-150S NBR
6.10 – 6.50	5.67	0.32	0.59	0.81	0.20	0.95	0.71 ± .070	154.9 – 165.1	V-160S NBR
6.50 – 6.89	6.02	0.32	0.59	0.81	0.20	0.95	0.71 ± .070	165.1 – 175.1	V-170S NBR
6.89 – 7.29	6.38	0.32	0.59	0.81	0.20	0.95	0.71 ± .070	175.1 – 195.1	V-180S NBR
7.68 – 8.27	7.09	0.32	0.59	0.81	0.20	0.95	0.71 ± .070	195.1 – 210.1	V-199S NBR

03/03/06



Gland Dimensions — V-Seal L Profile

All alphabetic dimensions are in inch

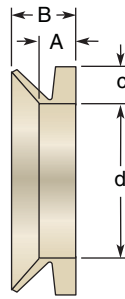

Profile Dimensions

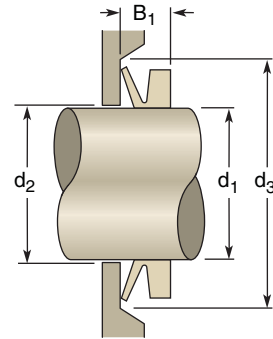

Assembly Dimensions

For Shaft Diameter d_1	Inside Diameter d	Height c	Dim. A	Free Width B	Max. $d_2 = d_1 +$	Min. $d_3 = d_1 +$	Fitted Width B_1	Metric Shaft Range	V-Seal Part Number
5.32 – 5.71	4.96	0.26	0.24	0.41	0.20	0.79	0.31 ± .06	135.1 – 145.0	V-140L NBR
5.71 – 6.10	5.31	0.26	0.24	0.41	0.20	0.79	0.31 ± .06	145.0 – 154.9	V-150L NBR
6.10 – 6.50	5.67	0.26	0.24	0.41	0.20	0.79	0.31 ± .06	154.9 – 165.1	V-160L NBR
6.50 – 6.89	6.02	0.26	0.24	0.41	0.20	0.79	0.31 ± .06	165.1 – 175.0	V-170L NBR
6.89 – 7.29	6.38	0.26	0.24	0.41	0.20	0.79	0.31 ± .06	175.0 – 185.1	V-180L NBR
7.29 – 7.68	6.73	0.26	0.24	0.41	0.20	0.79	0.31 ± .06	185.1 – 195.1	V-190L NBR
7.68 – 8.27	7.17	0.26	0.24	0.41	0.20	0.79	0.31 ± .06	195.1 – 210.1	V-200L NBR
8.27 – 9.17	7.80	0.26	0.24	0.41	0.20	0.79	0.31 ± .06	210.1 – 232.9	V-220L NBR
9.17 – 10.24	8.86	0.26	0.24	0.41	0.20	0.79	0.31 ± .06	232.9 – 260.1	V-250L NBR
10.24 – 11.22	9.72	0.26	0.24	0.41	0.20	0.79	0.31 ± .06	260.1 – 285.0	V-275L NBR
11.22 – 12.20	10.63	0.26	0.24	0.41	0.20	0.79	0.31 ± .06	285.0 – 310.0	V-300L NBR
12.20 – 13.19	11.50	0.26	0.24	0.41	0.20	0.79	0.31 ± .06	310.0 – 335.0	V-325L NBR
13.19 – 14.37	12.40	0.26	0.24	0.41	0.20	0.79	0.31 ± .06	335.0 – 365.0	V-350L NBR
14.37 – 15.15	13.27	0.26	0.24	0.41	0.20	0.79	0.31 ± .06	365.0 – 385.0	V-375L NBR
15.15 – 16.73	14.17	0.26	0.24	0.41	0.20	0.79	0.31 ± .06	385.0 – 424.9	V-400L NBR
16.73 – 18.70	15.94	0.26	0.24	0.41	0.20	0.79	0.31 ± .06	424.9 – 475.0	V-450L NBR



Gland Dimensions — V-Seal E Profile

All alphabetic dimensions are in inch

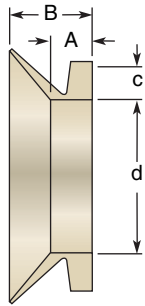

Profile Dimensions

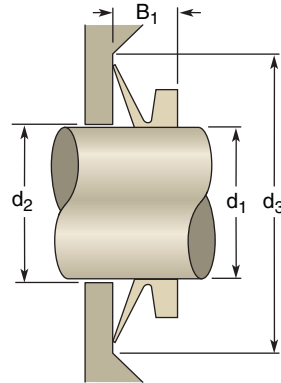

Assembly Dimensions

For Shaft Diameter d_1	Inside Diameter d	Height c	Dim. A	Free Width B	Max. $d_2 = d_1 +$	Min. $d_3 = d_1 +$	Fitted Width B_1	Metric Shaft Range	V-Seal Part Number
17.72 – 17.91	17.28	1.18	1.28	2.56	0.94	4.53	2.00 ± .50	450.1 – 454.9	V-450E NBR
17.91 – 18.11	17.48	1.18	1.28	2.56	0.94	4.53	2.00 ± .50	454.9 – 460.0	V-455E NBR
18.11 – 18.31	17.64	1.18	1.28	2.56	0.94	4.53	2.00 ± .50	460.0 – 465.1	V-460E NBR
18.31 – 18.50	17.39	1.18	1.28	2.56	0.94	4.53	2.00 ± .50	465.1 – 469.9	V-465E NBR
18.50 – 18.70	18.03	1.18	1.28	2.56	0.94	4.53	2.00 ± .50	469.9 – 475.0	V-470E NBR
18.70 – 18.90	18.23	1.18	1.28	2.56	0.94	4.53	2.00 ± .50	475.0 – 480.1	V-475E NBR
18.90 – 19.09	18.43	1.18	1.28	2.56	0.94	4.53	2.00 ± .50	480.1 – 484.9	V-480E NBR
19.09 – 19.29	18.62	1.18	1.28	2.56	0.94	4.53	2.00 ± .50	484.9 – 490.0	V-485E NBR
19.29 – 19.49	18.82	1.18	1.28	2.56	0.94	4.53	2.00 ± .50	490.0 – 495.0	V-490E NBR
19.49 – 19.69	19.02	1.18	1.28	2.56	0.94	4.53	2.00 ± .50	495.0 – 500.1	V-495E NBR
19.69 – 19.88	19.21	1.18	1.28	2.56	0.94	4.53	2.00 ± .50	500.1 – 505.0	V-500E NBR
19.88 – 20.08	19.41	1.18	1.28	2.56	0.94	4.53	2.00 ± .50	505.0 – 510.0	V-505E NBR
20.08 – 20.28	19.57	1.18	1.28	2.56	0.94	4.53	2.00 ± .50	510.0 – 515.1	V-510E NBR
20.28 – 20.47	19.76	1.18	1.28	2.56	0.94	4.53	2.00 ± .50	515.1 – 519.9	V-515E NBR
20.47 – 20.67	19.96	1.18	1.28	2.56	0.94	4.53	2.00 ± .50	519.9 – 525.0	V-520E NBR
20.67 – 20.87	20.16	1.18	1.28	2.56	0.94	4.53	2.00 ± .50	525.0 – 530.1	V-525E NBR
20.87 – 21.06	20.35	1.18	1.28	2.56	0.94	4.53	2.00 ± .50	530.1 – 534.9	V-530E NBR
21.06 – 21.26	20.51	1.18	1.28	2.56	0.94	4.53	2.00 ± .50	534.9 – 540.0	V-535E NBR
21.26 – 21.46	20.71	1.18	1.28	2.56	0.94	4.53	2.00 ± .50	540.0 – 545.1	V-540E NBR
21.46 – 21.65	20.91	1.18	1.28	2.56	0.94	4.53	2.00 ± .50	545.1 – 549.9	V-545E NBR
21.65 – 21.85	21.10	1.18	1.28	2.56	0.94	4.53	2.00 ± .50	549.9 – 555.0	V-550E NBR
21.85 – 22.05	21.30	1.18	1.28	2.56	0.94	4.53	2.00 ± .50	555.0 – 560.1	V-555E NBR
22.05 – 22.24	21.50	1.18	1.28	2.56	0.94	4.53	2.00 ± .50	560.1 – 564.9	V-560E NBR
22.24 – 22.44	21.65	1.18	1.28	2.56	0.94	4.53	2.00 ± .50	564.9 – 570.0	V-565E NBR
22.44 – 22.64	21.85	1.18	1.28	2.56	0.94	4.53	2.00 ± .50	570.0 – 575.1	V-570E NBR
22.64 – 22.84	22.05	1.18	1.28	2.56	0.94	4.53	2.00 ± .50	575.1 – 580.1	V-575E NBR
22.84 – 23.03	22.24	1.18	1.28	2.56	0.94	4.53	2.00 ± .50	580.1 – 585.0	V-580E NBR
23.03 – 23.23	22.44	1.18	1.28	2.56	0.94	4.53	2.00 ± .50	585.0 – 590.0	V-585E NBR
23.23 – 23.62	22.64	1.18	1.28	2.56	0.94	4.53	2.00 ± .50	590.0 – 599.9	V-590E NBR
23.62 – 24.02	22.91	1.18	1.28	2.56	0.94	4.53	2.00 ± .50	599.9 – 610.1	V-6WE NBR
24.02 – 24.41	23.31	1.18	1.28	2.56	0.94	4.53	2.00 ± .50	610.1 – 620.0	V-610E NBR
24.41 – 24.80	23.70	1.18	1.28	2.56	0.94	4.53	2.00 ± .50	620.0 – 629.9	V-620E NBR
24.80 – 25.20	24.09	1.18	1.28	2.56	0.94	4.53	2.00 ± .50	629.9 – 640.1	V-630E NBR
25.20 – 25.59	24.45	1.18	1.28	2.56	0.94	4.53	2.00 ± .50	640.1 – 650.0	V-640E NBR
25.59 – 25.98	24.84	1.18	1.28	2.56	0.94	4.53	2.00 ± .50	650.0 – 659.9	V-650E NBR
25.98 – 26.38	25.20	1.18	1.28	2.56	0.94	4.53	2.00 ± .50	659.9 – 670.1	V-660E NBR

03/03/06



All alphabetic dimensions are in inch

For Shaft Diameter d_1	Inside Diameter d	Height c	Dim. A	Free Width B	Max. $d_2 = d_1 +$	Min. $d_3 = d_1 +$	Fitted Width B_1	Metric Shaft Range	V-Seal Part Number
26.38 – 26.77	25.59	1.18	1.28	2.56	0.94	4.53	2.00 ± .50	670.1 – 680.0	V-670E NBR
26.77 – 27.17	25.98	1.18	1.28	2.56	0.94	4.53	2.00 ± .50	680.0 – 690.1	V-680E NBR
27.17 – 27.56	26.38	1.18	1.28	2.56	0.94	4.53	2.00 ± .50	690.1 – 700.0	V-690E NBR
27.56 – 27.95	26.77	1.18	1.28	2.56	0.94	4.53	2.00 ± .50	700.0 – 709.9	V-700E NBR
27.95 – 28.35	27.13	1.18	1.28	2.56	0.94	4.53	2.00 ± .50	709.9 – 720.1	V-710E NBR
28.35 – 28.74	27.52	1.18	1.28	2.56	0.94	4.53	2.00 ± .50	720.1 – 730.0	V-720E NBR
28.74 – 29.13	27.91	1.18	1.28	2.56	0.94	4.53	2.00 ± .50	730.0 – 739.9	V-730E NBR
29.13 – 29.53	28.27	1.18	1.28	2.56	0.94	4.53	2.00 ± .50	739.9 – 750.1	V-740E NBR
29.53 – 29.94	28.66	1.18	1.28	2.56	0.94	4.53	2.00 ± .50	750.1 – 757.9	V-750E NBR
29.94 – 30.16	28.94	1.18	1.28	2.56	0.94	4.53	2.00 ± .50	757.9 – 766.1	V-760E NBR
30.16 – 30.47	29.25	1.18	1.28	2.56	0.94	4.53	2.00 ± .50	766.1 – 773.9	V-770E NBR
30.47 – 30.83	29.57	1.18	1.28	2.56	0.94	4.53	2.00 ± .50	773.9 – 783.1	V-780E NBR
30.83 – 31.18	29.88	1.18	1.28	2.56	0.94	4.53	2.00 ± .50	783.1 – 792.0	V-790E NBR
31.18 – 31.54	30.24	1.18	1.28	2.56	0.94	4.53	2.00 ± .50	792.0 – 801.1	V-800E NBR
31.54 – 31.89	30.59	1.18	1.28	2.56	0.94	4.53	2.00 ± .50	801.1 – 810.0	V-810E NBR
31.89 – 32.32	30.95	1.18	1.28	2.56	0.94	4.53	2.00 ± .50	810.0 – 820.9	V-820E NBR
32.32 – 32.72	31.34	1.18	1.28	2.56	0.94	4.53	2.00 ± .50	820.9 – 831.1	V-830E NBR
32.72 – 33.11	31.69	1.18	1.28	2.56	0.94	4.53	2.00 ± .50	831.1 – 841.0	V-840E NBR
33.11 – 33.50	32.05	1.18	1.28	2.56	0.94	4.53	2.00 ± .50	841.0 – 850.9	V-850E NBR
33.50 – 33.90	32.44	1.18	1.28	2.56	0.94	4.53	2.00 ± .50	850.9 – 861.1	V-860E NBR
33.90 – 34.29	32.80	1.18	1.28	2.56	0.94	4.53	2.00 ± .50	861.1 – 871.0	V-870E NBR
34.29 – 34.72	33.19	1.18	1.28	2.56	0.94	4.53	2.00 ± .50	871.0 – 881.9	V-880E NBR
34.72 – 35.12	33.58	1.18	1.28	2.56	0.94	4.53	2.00 ± .50	881.9 – 892.0	V-890E NBR
35.12 – 35.91	34.29	1.18	1.28	2.56	0.94	4.53	2.00 ± .50	892.0 – 912.1	V-900E NBR
35.91 – 36.30	34.65	1.18	1.28	2.56	0.94	4.53	2.00 ± .50	912.1 – 922.0	V-920E NBR
36.30 – 36.73	35.04	1.18	1.28	2.56	0.94	4.53	2.00 ± .50	922.0 – 932.9	V-930E NBR
36.73 – 37.17	35.43	1.18	1.28	2.56	0.94	4.53	2.00 ± .50	932.9 – 944.1	V-940E NBR
37.17 – 37.60	35.87	1.18	1.28	2.56	0.94	4.53	2.00 ± .50	944.1 – 955.0	V-950E NBR
37.60 – 38.03	36.26	1.18	1.28	2.56	0.94	4.53	2.00 ± .50	955.0 – 966.0	V-960E NBR
38.03 – 38.47	36.69	1.18	1.28	2.56	0.94	4.53	2.00 ± .50	966.0 – 977.1	V-970E NBR
38.47 – 38.90	37.09	1.18	1.28	2.56	0.94	4.53	2.00 ± .50	977.1 – 988.1	V-980E NBR
38.90 – 39.33	37.52	1.18	1.28	2.56	0.94	4.53	2.00 ± .50	988.1 – 999.0	V-990E NBR
39.33 – 39.76	37.91	1.18	1.28	2.56	0.94	4.53	2.00 ± .50	999.0 – 1009.9	V-1000E NBR
39.76 – 40.35	38.31	1.18	1.28	2.56	0.94	4.53	2.00 ± .50	1009.9 – 1024.9	V-1020E NBR
40.35 – 41.14	38.98	1.18	1.28	2.56	0.94	4.53	2.00 ± .50	1024.9 – 1045.9	V-1040E NBR
41.14 – 41.93	39.69	1.18	1.28	2.56	0.94	4.53	2.00 ± .50	1045.9 – 1065.0	V-1060E NBR
41.93 – 42.72	40.43	1.18	1.28	2.56	0.94	4.53	2.00 ± .50	1065.0 – 1085.1	V-1080E NBR
42.72 – 43.50	41.14	1.18	1.28	2.56	0.94	4.53	2.00 ± .50	1085.1 – 1104.9	V-1100E NBR
43.50 – 44.29	41.93	1.18	1.28	2.56	0.94	4.53	2.00 ± .50	1104.9 – 1125.0	V-1120E NBR
44.29 – 45.08	42.68	1.18	1.28	2.56	0.94	4.53	2.00 ± .50	1125.0 – 1145.0	V-1140E NBR
45.08 – 45.87	43.43	1.18	1.28	2.56	0.94	4.53	2.00 ± .50	1145.0 – 1165.1	V-1160E NBR
45.87 – 46.65	44.13	1.18	1.28	2.56	0.94	4.53	2.00 ± .50	1165.1 – 1184.9	V-1180E NBR
46.65 – 47.44	44.84	1.18	1.28	2.56	0.94	4.53	2.00 ± .50	1184.9 – 1205.0	V-1200E NBR
47.44 – 48.23	45.55	1.18	1.28	2.56	0.94	4.53	2.00 ± .50	1205.0 – 1225.0	V-1220E NBR
48.23 – 49.02	46.30	1.18	1.28	2.56	0.94	4.53	2.00 ± .50	1225.0 – 1245.1	V-1240E NBR
49.02 – 50.00	47.05	1.18	1.28	2.56	0.94	4.53	2.00 ± .50	1245.1 – 1270.0	V-1260E NBR
50.00 – 50.98	47.95	1.18	1.28	2.56	0.94	4.53	2.00 ± .50	1270.0 – 1294.9	V-1280E NBR
50.98 – 51.77	48.82	1.18	1.28	2.56	0.94	4.53	2.00 ± .50	1294.9 – 1315.0	V-1300E NBR
51.77 – 52.76	49.57	1.18	1.28	2.56	0.94	4.53	2.00 ± .50	1315.0 – 1340.1	V-1325E NBR
52.76 – 53.74	50.43	1.18	1.28	2.56	0.94	4.53	2.00 ± .50	1340.1 – 1365.0	V-1350E NBR
53.74 – 54.72	51.38	1.18	1.28	2.56	0.94	4.53	2.00 ± .50	1365.0 – 1389.9	V-1375E NBR
54.72 – 55.71	52.28	1.18	1.28	2.56	0.94	4.53	2.00 ± .50	1389.9 – 1415.0	V-1400E NBR



03/03/06



Sleeve & V-Seal Sizes

All alphabetic dimensions are in inch

For Shaft Diameter d_1	Inside Diameter d	Height c	Dim. A	Free Width B	Max. d_2 $= d_1 +$	Min. d_3 $= d_1 +$	Fitted Width B_1	Metric Shaft Range	V-Seal Part Number
55.71 – 56.69	53.15	1.18	1.28	2.56	0.94	4.53	2.00 ± .50	1415.0 – 1439.9	V-1425E NBR
56.69 – 57.68	54.09	1.18	1.28	2.56	0.94	4.53	2.00 ± .50	1439.9 – 1465.1	V-1450E NBR
57.68 – 58.66	55.00	1.18	1.28	2.56	0.94	4.53	2.00 ± .50	1465.1 – 1490.0	V-1475E NBR
58.66 – 59.65	55.87	1.18	1.28	2.56	0.94	4.53	2.00 ± .50	1490.0 – 1515.1	V-1500E NBR
59.65 – 60.63	56.81	1.18	1.28	2.56	0.94	4.53	2.00 ± .50	1515.1 – 1540.0	V-1525E NBR
60.63 – 61.81	57.76	1.18	1.28	2.56	0.94	4.53	2.00 ± .50	1540.0 – 1570.0	V-1550E NBR
61.81 – 62.99	58.86	1.18	1.28	2.56	0.94	4.53	2.00 ± .50	1570.0 – 1599.9	V-1575E NBR
62.99 – 64.57	60.00	1.18	1.28	2.56	0.94	4.53	2.00 ± .50	1599.9 – 1640.1	V-1600E NBR
64.57 – 66.14	61.38	1.18	1.28	2.56	0.94	4.53	2.00 ± .50	1640.1 – 1680.0	V-1650E NBR
66.14 – 67.72	62.84	1.18	1.28	2.56	0.94	4.53	2.00 ± .50	1680.0 – 1720.1	V-1700E NBR
67.72 – 69.49	64.25	1.18	1.28	2.56	0.94	4.53	2.00 ± .50	1720.1 – 1765.0	V-1750E NBR
69.49 – 71.26	65.79	1.18	1.28	2.56	0.94	4.53	2.00 ± .50	1765.0 – 1810.0	V-1800E NBR
71.26 – 73.03	67.48	1.18	1.28	2.56	0.94	4.53	2.00 ± .50	1810.0 – 1855.0	V-1850E NBR
73.03 – 75.00	69.02	1.18	1.28	2.56	0.94	4.53	2.00 ± .50	1855.0 – 1905.0	V-1900E NBR
75.00 – 76.97	70.63	1.18	1.28	2.56	0.94	4.53	2.00 ± .50	1905.0 – 1955.0	V-1950E NBR
76.97 – 79.13	72.60	1.18	1.28	2.56	0.94	4.53	2.00 ± .50	1955.0 – 2009.9	V-2000E NBR

E

03/03/06



ProTech™ Sizes Inch

0.500 to 0.563

Catalog EPS 5350/USA

Shaft Dia.	Bore Dia.	Total In Bore Depth	Total Seal Width	ProTech Part Number
0.500	1.000	0.276	0.630	LWE-0500-1000-1-1
0.500	1.063	0.276	0.630	LWE-0500-1063-1-1
0.500	1.125	0.276	0.630	LWE-0500-1125-1-1
0.500	1.125	0.313	0.688	LSE-0500-1125-1-1
0.500	1.188	0.276	0.630	LWE-0500-1188-1-1
0.500	1.188	0.313	0.688	LSE-0500-1188-1-1
0.500	1.250	0.276	0.630	LWE-0500-1250-1-1
0.500	1.250	0.313	0.688	LSE-0500-1250-1-1
0.500	1.250	0.313	0.688	FSE-0500-1250-1-1
0.500	1.250	0.562	0.562	LNE-0500-1250-1-1
0.500	1.250	0.591	0.591	FNE-0500-1250-1-1
0.500	1.313	0.276	0.630	LWE-0500-1313-1-1
0.500	1.313	0.313	0.688	LSE-0500-1313-1-1
0.500	1.313	0.313	0.688	FSE-0500-1313-1-1
0.500	1.313	0.562	0.562	LNE-0500-1313-1-1
0.500	1.313	0.591	0.591	FNE-0500-1313-1-1
0.500	1.375	0.276	0.630	LWE-0500-1375-1-1
0.500	1.375	0.313	0.688	LSE-0500-1375-1-1
0.500	1.375	0.313	0.688	FSE-0500-1375-1-1
0.500	1.375	0.562	0.562	LNE-0500-1375-1-1
0.500	1.375	0.591	0.591	FNE-0500-1375-1-1
0.500	1.438	0.276	0.630	LWE-0500-1438-1-1
0.500	1.438	0.313	0.688	LSE-0500-1438-1-1
0.500	1.438	0.313	0.688	FSE-0500-1438-1-1
0.500	1.438	0.562	0.562	LNE-0500-1438-1-1
0.500	1.438	0.591	0.591	FNE-0500-1438-1-1
0.500	1.500	0.276	0.630	LWE-0500-1500-1-1
0.500	1.500	0.313	0.688	LSE-0500-1500-1-1
0.500	1.500	0.313	0.688	FSE-0500-1500-1-1
0.500	1.500	0.562	0.562	LNE-0500-1500-1-1
0.500	1.500	0.591	0.591	FNE-0500-1500-1-1
0.500	1.563	0.276	0.630	LWE-0500-1563-1-1
0.500	1.563	0.313	0.688	LSE-0500-1563-1-1
0.500	1.563	0.313	0.688	FSE-0500-1563-1-1
0.500	1.563	0.562	0.562	LNE-0500-1563-1-1
0.500	1.563	0.591	0.591	FNE-0500-1563-1-1
0.500	1.625	0.276	0.630	LWE-0500-1625-1-1
0.500	1.625	0.313	0.688	LSE-0500-1625-1-1
0.500	1.625	0.313	0.688	FSE-0500-1625-1-1
0.500	1.625	0.562	0.562	LNE-0500-1625-1-1
0.500	1.625	0.591	0.591	FNE-0500-1625-1-1
0.500	1.688	0.276	0.630	LWE-0500-1688-1-1
0.500	1.688	0.313	0.688	LSE-0500-1688-1-1
0.500	1.688	0.313	0.688	FSE-0500-1688-1-1
0.500	1.688	0.562	0.562	LNE-0500-1688-1-1
0.500	1.688	0.591	0.591	FNE-0500-1688-1-1
0.500	1.750	0.276	0.630	LWE-0500-1750-1-1
0.500	1.750	0.313	0.688	LSE-0500-1750-1-1
0.500	1.750	0.313	0.688	FSE-0500-1750-1-1
0.500	1.750	0.562	0.562	LNE-0500-1750-1-1
0.500	1.750	0.591	0.591	FNE-0500-1750-1-1
0.500	1.813	0.276	0.630	LWE-0500-1813-1-1
0.500	1.813	0.313	0.688	LSE-0500-1813-1-1
0.500	1.813	0.313	0.688	FSE-0500-1813-1-1
0.500	1.813	0.562	0.562	LNE-0500-1813-1-1
0.500	1.813	0.591	0.591	FNE-0500-1813-1-1
0.500	1.875	0.276	0.630	LWE-0500-1875-1-1
0.500	1.875	0.313	0.688	LSE-0500-1875-1-1
0.500	1.875	0.313	0.688	FSE-0500-1875-1-1
0.500	1.875	0.562	0.562	LNE-0500-1875-1-1

Shaft Dia.	Bore Dia.	Total In Bore Depth	Total Seal Width	ProTech Part Number
0.500	1.875	0.591	0.591	FNE-0500-1875-1-1
0.500	1.938	0.276	0.630	LWE-0500-1938-1-1
0.500	1.938	0.313	0.688	LSE-0500-1938-1-1
0.500	1.938	0.313	0.688	FSE-0500-1938-1-1
0.500	1.938	0.562	0.562	LNE-0500-1938-1-1
0.500	1.938	0.591	0.591	FNE-0500-1938-1-1
0.500	2.000	0.276	0.630	LWE-0500-2000-1-1
0.500	2.000	0.313	0.688	LSE-0500-2000-1-1
0.500	2.000	0.313	0.688	FSE-0500-2000-1-1
0.500	2.000	0.562	0.562	LNE-0500-2000-1-1
0.500	2.000	0.591	0.591	FNE-0500-2000-1-1
0.562	1.250	0.313	0.688	LSE-0562-1250-1-1
0.562	1.312	0.313	0.688	LSE-0562-1312-1-1
0.562	1.375	0.313	0.688	LSE-0562-1375-1-1
0.562	1.437	0.313	0.688	LSE-0562-1437-1-1
0.562	1.500	0.313	0.688	LSE-0562-1500-1-1
0.562	1.562	0.313	0.688	LSE-0562-1562-1-1
0.562	1.625	0.313	0.688	LSE-0562-1625-1-1
0.562	1.687	0.313	0.688	LSE-0562-1687-1-1
0.562	1.750	0.313	0.688	LSE-0562-1750-1-1
0.562	1.812	0.313	0.688	LSE-0562-1812-1-1
0.562	1.875	0.313	0.688	LSE-0562-1875-1-1
0.562	1.937	0.313	0.688	LSE-0562-1937-1-1
0.562	2.000	0.313	0.688	LSE-0562-2000-1-1
0.562	2.062	0.313	0.688	LSE-0562-2062-1-1
0.563	1.063	0.276	0.630	LWE-0563-1063-1-1
0.563	1.125	0.276	0.630	LWE-0563-1126-1-1
0.563	1.187	0.313	0.688	LSE-0562-1187-1-1
0.563	1.188	0.276	0.630	LWE-0563-1188-1-1
0.563	1.250	0.276	0.630	LWE-0563-1251-1-1
0.563	1.312	0.313	0.688	FSE-0563-1312-1-1
0.563	1.312	0.562	0.562	LNE-0563-1312-1-1
0.563	1.312	0.591	0.591	FNE-0563-1312-1-1
0.563	1.313	0.276	0.630	LWE-0563-1313-1-1
0.563	1.375	0.276	0.630	LWE-0563-1376-1-1
0.563	1.375	0.313	0.688	FSE-0563-1375-1-1
0.563	1.375	0.562	0.562	LNE-0563-1375-1-1
0.563	1.375	0.591	0.591	FNE-0563-1375-1-1
0.563	1.437	0.313	0.688	FSE-0563-1437-1-1
0.563	1.437	0.562	0.562	LNE-0563-1437-1-1
0.563	1.437	0.591	0.591	FNE-0563-1437-1-1
0.563	1.438	0.276	0.630	LWE-0563-1438-1-1
0.563	1.500	0.276	0.630	LWE-0563-1501-1-1
0.563	1.500	0.313	0.688	FSE-0563-1500-1-1
0.563	1.500	0.562	0.562	LNE-0563-1500-1-1
0.563	1.500	0.591	0.591	FNE-0563-1500-1-1
0.563	1.562	0.313	0.688	FSE-0563-1562-1-1
0.563	1.562	0.562	0.562	LNE-0563-1562-1-1
0.563	1.562	0.591	0.591	FNE-0563-1562-1-1
0.563	1.563	0.276	0.630	LWE-0563-1563-1-1
0.563	1.625	0.276	0.630	LWE-0563-1626-1-1
0.563	1.625	0.313	0.688	FSE-0563-1625-1-1
0.563	1.625	0.562	0.562	LNE-0563-1625-1-1
0.563	1.625	0.591	0.591	FNE-0563-1625-1-1
0.563	1.687	0.313	0.688	FSE-0563-1687-1-1
0.563	1.687	0.562	0.562	LNE-0563-1687-1-1
0.563	1.687	0.591	0.591	FNE-0563-1687-1-1
0.563	1.688	0.276	0.630	LWE-0563-1688-1-1
0.563	1.750	0.276	0.630	LWE-0563-1750-1-1
0.563	1.750	0.313	0.688	FSE-0563-1750-1-1



See Section 4 for seal part number prefix description.

03/03/06



Shaft Dia.	Bore Dia.	Total In Bore Depth	Total Seal Width	ProTech Part Number
0.563	1.750	0.562	0.562	LNE-0563-1750-1-1
0.563	1.750	0.591	0.591	FNE-0563-1750-1-1
0.563	1.812	0.313	0.688	FSE-0563-1812-1-1
0.563	1.812	0.562	0.562	LNE-0563-1812-1-1
0.563	1.812	0.591	0.591	FNE-0563-1812-1-1
0.563	1.813	0.276	0.630	LWE-0563-1813-1-1
0.563	1.875	0.276	0.630	LWE-0563-1875-1-1
0.563	1.875	0.313	0.688	FSE-0563-1875-1-1
0.563	1.875	0.562	0.562	LNE-0563-1875-1-1
0.563	1.875	0.591	0.591	FNE-0563-1875-1-1
0.563	1.937	0.313	0.688	FSE-0563-1937-1-1
0.563	1.937	0.562	0.562	LNE-0563-1937-1-1
0.563	1.937	0.591	0.591	FNE-0563-1937-1-1
0.563	1.938	0.276	0.630	LWE-0563-1938-1-1
0.563	2.000	0.276	0.630	LWE-0563-2000-1-1
0.563	2.000	0.313	0.688	FSE-0563-2000-1-1
0.563	2.000	0.562	0.562	LNE-0563-2000-1-1
0.563	2.000	0.591	0.591	FNE-0563-2000-1-1
0.563	2.062	0.313	0.688	FSE-0563-2062-1-1
0.563	2.062	0.562	0.562	LNE-0563-2062-1-1
0.563	2.062	0.591	0.591	FNE-0563-2062-1-1
0.563	2.063	0.276	0.630	LWE-0563-2063-1-1
0.625	1.125	0.276	0.551	MLE-0625-1125-B-1
0.625	1.125	0.276	0.630	LWE-0625-1125-1-1
0.625	1.188	0.276	0.551	MLE-0625-1188-B-1
0.625	1.188	0.276	0.630	LWE-0625-1188-1-1
0.625	1.250	0.276	0.551	MLE-0625-1250-B-1
0.625	1.250	0.276	0.630	LWE-0625-1250-1-1
0.625	1.250	0.313	0.688	LSE-0625-1250-1-1
0.625	1.312	0.313	0.688	LSE-0625-1312-1-1
0.625	1.313	0.276	0.551	MLE-0625-1313-B-1
0.625	1.313	0.276	0.630	LWE-0625-1313-1-1
0.625	1.375	0.276	0.551	MLE-0625-1375-B-1
0.625	1.375	0.276	0.630	LWE-0625-1375-1-1
0.625	1.375	0.313	0.688	LSE-0625-1375-1-1
0.625	1.375	0.313	0.688	FSE-0625-1375-1-1
0.625	1.375	0.562	0.562	LNE-0625-1375-1-1
0.625	1.375	0.591	0.591	FNE-0625-1375-1-1
0.625	1.438	0.276	0.551	MLE-0625-1438-B-1
0.625	1.438	0.276	0.630	LWE-0625-1438-1-1
0.625	1.438	0.313	0.688	LSE-0625-1438-1-1
0.625	1.438	0.313	0.688	FSE-0625-1438-1-1
0.625	1.438	0.562	0.562	LNE-0625-1438-1-1
0.625	1.438	0.591	0.591	FNE-0625-1438-1-1
0.625	1.500	0.276	0.551	MLE-0625-1500-B-1
0.625	1.500	0.276	0.630	LWE-0625-1500-1-1
0.625	1.500	0.313	0.688	LSE-0625-1500-1-1
0.625	1.500	0.313	0.688	FSE-0625-1500-1-1
0.625	1.500	0.562	0.562	LNE-0625-1500-1-1
0.625	1.500	0.591	0.591	FNE-0625-1500-1-1
0.625	1.562	0.313	0.688	LSE-0625-1562-1-1
0.625	1.562	0.313	0.688	FSE-0625-1562-1-1
0.625	1.562	0.562	0.562	LNE-0625-1562-1-1
0.625	1.562	0.591	0.591	FNE-0625-1562-1-1
0.625	1.563	0.276	0.551	MLE-0625-1563-B-1
0.625	1.563	0.276	0.630	LWE-0625-1563-1-1
0.625	1.625	0.276	0.551	MLE-0625-1625-B-1
0.625	1.625	0.276	0.630	LWE-0625-1625-1-1
0.625	1.625	0.313	0.688	LSE-0625-1625-1-1
0.625	1.625	0.313	0.688	FSE-0625-1625-1-1
0.625	1.625	0.562	0.562	LNE-0625-1625-1-1
0.625	1.625	0.591	0.591	FNE-0625-1625-1-1
0.625	1.688	0.276	0.551	MLE-0625-1688-B-1
0.625	1.688	0.276	0.630	LWE-0625-1688-1-1
0.625	1.688	0.313	0.688	LSE-0625-1688-1-1
0.625	1.688	0.313	0.688	FSE-0625-1688-1-1

Shaft Dia.	Bore Dia.	Total In Bore Depth	Total Seal Width	ProTech Part Number
0.625	1.688	0.562	0.562	LNE-0625-1688-1-1
0.625	1.688	0.591	0.591	FNE-0625-1688-1-1
0.625	1.750	0.276	0.551	MLE-0625-1750-B-1
0.625	1.750	0.276	0.630	LWE-0625-1750-1-1
0.625	1.750	0.313	0.688	LSE-0625-1750-1-1
0.625	1.750	0.313	0.688	FSE-0625-1750-1-1
0.625	1.750	0.562	0.562	LNE-0625-1750-1-1
0.625	1.750	0.591	0.591	FNE-0625-1750-1-1
0.625	1.813	0.276	0.551	MLE-0625-1813-B-1
0.625	1.813	0.276	0.630	LWE-0625-1813-1-1
0.625	1.813	0.313	0.688	LSE-0625-1813-1-1
0.625	1.813	0.313	0.688	FSE-0625-1813-1-1
0.625	1.813	0.562	0.562	LNE-0625-1813-1-1
0.625	1.813	0.591	0.591	FNE-0625-1813-1-1
0.625	1.813	0.591	0.591	FNE-0625-1813-1-1
0.625	1.875	0.276	0.551	MLE-0625-1875-B-1
0.625	1.875	0.276	0.630	LWE-0625-1875-1-1
0.625	1.875	0.313	0.688	LSE-0625-1875-1-1
0.625	1.875	0.313	0.688	FSE-0625-1875-1-1
0.625	1.875	0.562	0.562	LNE-0625-1875-1-1
0.625	1.875	0.591	0.591	FNE-0625-1875-1-1
0.625	1.938	0.276	0.551	MLE-0625-1938-B-1
0.625	1.938	0.276	0.630	LWE-0625-1938-1-1
0.625	1.938	0.313	0.688	LSE-0625-1938-1-1
0.625	1.938	0.313	0.688	FSE-0625-1938-1-1
0.625	1.938	0.562	0.562	LNE-0625-1938-1-1
0.625	1.938	0.591	0.591	FNE-0625-1938-1-1
0.625	2.000	0.276	0.551	MLE-0625-2000-B-1
0.625	2.000	0.276	0.630	LWE-0625-2000-1-1
0.625	2.000	0.313	0.688	LSE-0625-2000-1-1
0.625	2.000	0.313	0.688	FSE-0625-2000-1-1
0.625	2.000	0.562	0.562	LNE-0625-2000-1-1
0.625	2.000	0.591	0.591	FNE-0625-2000-1-1
0.625	2.062	0.313	0.688	LSE-0625-2062-1-1
0.625	2.062	0.313	0.688	FSE-0625-2062-1-1
0.625	2.062	0.562	0.562	LNE-0625-2062-1-1
0.625	2.062	0.591	0.591	FNE-0625-2062-1-1
0.625	2.063	0.276	0.551	MLE-0625-2063-B-1
0.625	2.063	0.276	0.630	LWE-0625-2063-1-1
0.625	2.125	0.276	0.551	MLE-0625-2125-B-1
0.625	2.125	0.276	0.630	LWE-0625-2125-1-1
0.625	2.125	0.313	0.688	LSE-0625-2125-1-1
0.625	2.125	0.313	0.688	FSE-0625-2125-1-1
0.625	2.125	0.562	0.562	LNE-0625-2125-1-1
0.625	2.125	0.591	0.591	FNE-0625-2125-1-1
0.688	1.188	0.276	0.551	MLE-0688-1188-B-1
0.688	1.188	0.276	0.630	LWE-0688-1188-1-1
0.688	1.250	0.276	0.551	MLE-0688-1250-B-1
0.688	1.250	0.276	0.630	LWE-0688-1250-1-1
0.688	1.313	0.276	0.551	MLE-0688-1313-B-1
0.688	1.313	0.276	0.630	LWE-0688-1313-1-1
0.688	1.313	0.313	0.688	LSE-0688-1313-1-1
0.688	1.375	0.276	0.551	MLE-0688-1375-B-1
0.688	1.375	0.276	0.630	LWE-0688-1375-1-1
0.688	1.375	0.313	0.688	LSE-0688-1375-1-1
0.688	1.375	0.313	0.688	FSE-0688-1375-1-1
0.688	1.438	0.276	0.551	MLE-0688-1438-B-1
0.688	1.438	0.276	0.630	LWE-0688-1438-1-1
0.688	1.438	0.313	0.688	LSE-0688-1438-1-1
0.688	1.438	0.313	0.688	FSE-0688-1438-1-1
0.688	1.438	0.562	0.562	LNE-0688-1438-1-1
0.688	1.438	0.591	0.591	FNE-0688-1438-1-1
0.688	1.500	0.276	0.551	MLE-0688-1500-B-1
0.688	1.500	0.276	0.630	LWE-0688-1500-1-1
0.688	1.500	0.313	0.688	LSE-0688-1500-1-1
0.688	1.500	0.313	0.688	FSE-0688-1500-1-1
0.688	1.500	0.562	0.562	LNE-0688-1500-1-1
0.688	1.500	0.591	0.591	FNE-0688-1500-1-1

See Section 4 for seal part number prefix description.

03/03/06



0.688 to 0.750

Shaft Dia.	Bore Dia.	Total In Bore Depth	Total Seal Width	ProTech Part Number
0.688	1.563	0.276	0.551	MLE-0688-1563-B-1
0.688	1.563	0.276	0.630	LWE-0688-1563-1-1
0.688	1.563	0.313	0.688	LSE-0688-1563-1-1
0.688	1.563	0.313	0.688	FSE-0688-1563-1-1
0.688	1.563	0.562	0.562	LNE-0688-1563-1-1
0.688	1.563	0.591	0.591	FNE-0688-1563-1-1
0.688	1.625	0.276	0.551	MLE-0688-1625-B-1
0.688	1.625	0.276	0.630	LWE-0688-1625-1-1
0.688	1.625	0.313	0.688	LSE-0688-1625-1-1
0.688	1.625	0.313	0.688	FSE-0688-1625-1-1
0.688	1.625	0.562	0.562	LNE-0688-1625-1-1
0.688	1.625	0.591	0.591	FNE-0688-1625-1-1
0.688	1.688	0.276	0.551	MLE-0688-1688-B-1
0.688	1.688	0.276	0.630	LWE-0688-1688-1-1
0.688	1.688	0.313	0.688	LSE-0688-1688-1-1
0.688	1.688	0.313	0.688	FSE-0688-1688-1-1
0.688	1.688	0.562	0.562	LNE-0688-1688-1-1
0.688	1.688	0.591	0.591	FNE-0688-1688-1-1
0.688	1.750	0.276	0.551	MLE-0688-1750-B-1
0.688	1.750	0.276	0.630	LWE-0688-1750-1-1
0.688	1.750	0.313	0.688	LSE-0688-1750-1-1
0.688	1.750	0.313	0.688	FSE-0688-1750-1-1
0.688	1.750	0.562	0.562	LNE-0688-1750-1-1
0.688	1.750	0.591	0.591	FNE-0688-1750-1-1
0.688	1.813	0.276	0.551	MLE-0688-1813-B-1
0.688	1.813	0.276	0.630	LWE-0688-1813-1-1
0.688	1.813	0.313	0.688	LSE-0688-1813-1-1
0.688	1.813	0.313	0.688	FSE-0688-1813-1-1
0.688	1.813	0.562	0.562	LNE-0688-1813-1-1
0.688	1.813	0.591	0.591	FNE-0688-1813-1-1
0.688	1.875	0.276	0.551	MLE-0688-1875-B-1
0.688	1.875	0.276	0.630	LWE-0688-1875-1-1
0.688	1.875	0.313	0.688	LSE-0688-1875-1-1
0.688	1.875	0.313	0.688	FSE-0688-1875-1-1
0.688	1.875	0.562	0.562	LNE-0688-1875-1-1
0.688	1.875	0.591	0.591	FNE-0688-1875-1-1
0.688	1.938	0.276	0.551	MLE-0688-1938-B-1
0.688	1.938	0.276	0.630	LWE-0688-1938-1-1
0.688	1.938	0.313	0.688	LSE-0688-1938-1-1
0.688	1.938	0.313	0.688	FSE-0688-1938-1-1
0.688	1.938	0.562	0.562	LNE-0688-1938-1-1
0.688	1.938	0.591	0.591	FNE-0688-1938-1-1
0.688	2.000	0.276	0.551	MLE-0688-2000-B-1
0.688	2.000	0.276	0.630	LWE-0688-2000-1-1
0.688	2.000	0.313	0.688	LSE-0688-2000-1-1
0.688	2.000	0.313	0.688	FSE-0688-2000-1-1
0.688	2.000	0.562	0.562	LNE-0688-2000-1-1
0.688	2.000	0.591	0.591	FNE-0688-2000-1-1
0.688	2.063	0.276	0.551	MLE-0688-2063-B-1
0.688	2.063	0.276	0.630	LWE-0688-2063-1-1
0.688	2.063	0.313	0.688	LSE-0688-2063-1-1
0.688	2.063	0.313	0.688	FSE-0688-2063-1-1
0.688	2.063	0.562	0.562	LNE-0688-2063-1-1
0.688	2.063	0.591	0.591	FNE-0688-2063-1-1
0.688	2.125	0.276	0.551	MLE-0688-2125-B-1
0.688	2.125	0.276	0.630	LWE-0688-2125-1-1
0.688	2.125	0.313	0.688	LSE-0688-2125-1-1
0.688	2.125	0.313	0.688	FSE-0688-2125-1-1
0.688	2.125	0.562	0.562	LNE-0688-2125-1-1
0.688	2.125	0.591	0.591	FNE-0688-2125-1-1
0.688	2.188	0.276	0.551	MLE-0688-2188-B-1
0.688	2.188	0.276	0.630	LWE-0688-2188-1-1
0.688	2.188	0.313	0.688	LSE-0688-2188-1-1
0.688	2.188	0.313	0.688	FSE-0688-2188-1-1
0.688	2.188	0.562	0.562	LNE-0688-2188-1-1
0.688	2.188	0.591	0.591	FNE-0688-2188-1-1

Shaft Dia.	Bore Dia.	Total In Bore Depth	Total Seal Width	ProTech Part Number
0.750	1.250	0.276	0.551	MLE-0750-1250-B-1
0.750	1.250	0.276	0.630	LWE-0750-1250-1-1
0.750	1.313	0.276	0.551	MLE-0750-1313-B-1
0.750	1.313	0.276	0.630	LWE-0750-1313-1-1
0.750	1.375	0.276	0.551	MLE-0750-1375-B-1
0.750	1.375	0.276	0.630	LWE-0750-1375-1-1
0.750	1.375	0.313	0.688	LSE-0750-1375-1-1
0.750	1.438	0.276	0.551	MLE-0750-1438-B-1
0.750	1.438	0.276	0.630	LWE-0750-1438-1-1
0.750	1.438	0.313	0.688	LSE-0750-1438-1-1
0.750	1.500	0.276	0.551	MLE-0750-1500-B-1
0.750	1.500	0.276	0.630	LWE-0750-1500-1-1
0.750	1.500	0.313	0.688	LSE-0750-1500-1-1
0.750	1.500	0.313	0.688	FSE-0750-1500-1-1
0.750	1.500	0.562	0.562	LNE-0750-1500-1-1
0.750	1.500	0.591	0.591	FNE-0750-1500-1-1
0.750	1.562	0.313	0.688	LSE-0750-1562-1-1
0.750	1.562	0.313	0.688	FSE-0750-1562-1-1
0.750	1.562	0.562	0.562	LNE-0750-1562-1-1
0.750	1.562	0.591	0.591	FNE-0750-1562-1-1
0.750	1.563	0.276	0.551	MLE-0750-1563-B-1
0.750	1.563	0.276	0.630	LWE-0750-1563-1-1
0.750	1.625	0.276	0.551	MLE-0750-1625-B-1
0.750	1.625	0.276	0.630	LWE-0750-1625-1-1
0.750	1.625	0.313	0.688	LSE-0750-1625-1-1
0.750	1.625	0.313	0.688	FSE-0750-1625-1-1
0.750	1.625	0.562	0.562	LNE-0750-1625-1-1
0.750	1.625	0.591	0.591	FNE-0750-1625-1-1
0.750	1.688	0.276	0.551	MLE-0750-1688-B-1
0.750	1.688	0.276	0.630	LWE-0750-1688-1-1
0.750	1.688	0.313	0.688	LSE-0750-1688-1-1
0.750	1.688	0.313	0.688	FSE-0750-1688-1-1
0.750	1.688	0.562	0.562	LNE-0750-1688-1-1
0.750	1.688	0.591	0.591	FNE-0750-1688-1-1
0.750	1.750	0.276	0.551	MLE-0750-1750-B-1
0.750	1.750	0.276	0.630	LWE-0750-1750-1-1
0.750	1.750	0.313	0.688	LSE-0750-1750-1-1
0.750	1.750	0.313	0.688	FSE-0750-1750-1-1
0.750	1.750	0.562	0.562	LNE-0750-1750-1-1
0.750	1.750	0.591	0.591	FNE-0750-1750-1-1
0.750	1.812	0.313	0.688	LSE-0750-1812-1-1
0.750	1.812	0.313	0.688	FSE-0750-1812-1-1
0.750	1.812	0.562	0.562	LNE-0750-1812-1-1
0.750	1.812	0.591	0.591	FNE-0750-1812-1-1
0.750	1.813	0.276	0.551	MLE-0750-1813-B-1
0.750	1.813	0.276	0.630	LWE-0750-1813-1-1
0.750	1.875	0.276	0.551	MLE-0750-1875-B-1
0.750	1.875	0.276	0.630	LWE-0750-1875-1-1
0.750	1.875	0.313	0.688	LSE-0750-1875-1-1
0.750	1.875	0.313	0.688	FSE-0750-1875-1-1
0.750	1.875	0.562	0.562	LNE-0750-1875-1-1
0.750	1.875	0.591	0.591	FNE-0750-1875-1-1
0.750	1.938	0.276	0.551	MLE-0750-1938-B-1
0.750	1.938	0.276	0.630	LWE-0750-1938-1-1
0.750	1.938	0.313	0.688	LSE-0750-1938-1-1
0.750	1.938	0.313	0.688	FSE-0750-1938-1-1
0.750	1.938	0.562	0.562	LNE-0750-1938-1-1
0.750	1.938	0.591	0.591	FNE-0750-1938-1-1
0.750	2.000	0.276	0.551	MLE-0750-2000-B-1
0.750	2.000	0.276	0.630	LWE-0750-2000-1-1
0.750	2.000	0.313	0.688	LSE-0750-2000-1-1
0.750	2.000	0.313	0.688	FSE-0750-2000-1-1
0.750	2.000	0.562	0.562	LNE-0750-2000-1-1
0.750	2.000	0.591	0.591	FNE-0750-2000-1-1
0.750	2.062	0.313	0.688	LSE-0750-2062-1-1
0.750	2.062	0.313	0.688	FSE-0750-2062-1-1



03/03/06

See **Section 4** for seal part number prefix description.



Shaft Dia.	Bore Dia.	Total In Bore Depth	Total Seal Width	ProTech Part Number
0.750	2.062	0.562	0.562	LNE-0750-2062-1-1
0.750	2.062	0.591	0.591	FNE-0750-2062-1-1
0.750	2.063	0.276	0.551	MLE-0750-2063-B-1
0.750	2.063	0.276	0.630	LWE-0750-2063-1-1
0.750	2.125	0.276	0.551	MLE-0750-2125-B-1
0.750	2.125	0.276	0.630	LWE-0750-2125-1-1
0.750	2.125	0.313	0.688	LSE-0750-2125-1-1
0.750	2.125	0.313	0.688	FSE-0750-2125-1-1
0.750	2.125	0.562	0.562	LNE-0750-2125-1-1
0.750	2.125	0.591	0.591	FNE-0750-2125-1-1
0.750	2.188	0.276	0.551	MLE-0750-2188-B-1
0.750	2.188	0.276	0.630	LWE-0750-2188-1-1
0.750	2.188	0.313	0.688	LSE-0750-2188-1-1
0.750	2.188	0.313	0.688	FSE-0750-2188-1-1
0.750	2.188	0.562	0.562	LNE-0750-2188-1-1
0.750	2.188	0.591	0.591	FNE-0750-2188-1-1
0.750	2.250	0.276	0.551	MLE-0750-2250-B-1
0.750	2.250	0.276	0.630	LWE-0750-2250-1-1
0.750	2.250	0.313	0.688	LSE-0750-2250-1-1
0.750	2.250	0.313	0.688	FSE-0750-2250-1-1
0.750	2.250	0.562	0.562	LNE-0750-2250-1-1
0.750	2.250	0.591	0.591	FNE-0750-2250-1-1
0.812	1.437	0.313	0.688	LSE-0812-1437-1-1
0.812	1.500	0.313	0.688	LSE-0812-1500-1-1
0.812	1.562	0.313	0.688	LSE-0812-1562-1-1
0.812	1.625	0.313	0.688	LSE-0812-1625-1-1
0.812	1.687	0.313	0.688	LSE-0812-1687-1-1
0.812	1.750	0.313	0.688	LSE-0812-1750-1-1
0.812	1.812	0.313	0.688	LSE-0812-1812-1-1
0.812	1.875	0.313	0.688	LSE-0812-1875-1-1
0.812	1.937	0.313	0.688	LSE-0812-1937-1-1
0.812	2.000	0.313	0.688	LSE-0812-2000-1-1
0.812	2.062	0.313	0.688	LSE-0812-2062-1-1
0.812	2.125	0.313	0.688	LSE-0812-2125-1-1
0.812	2.187	0.313	0.688	LSE-0812-2187-1-1
0.812	2.250	0.313	0.688	LSE-0812-2250-1-1
0.812	2.312	0.313	0.688	LSE-0812-2312-1-1
0.813	1.313	0.276	0.551	MLE-0813-1313-B-1
0.813	1.313	0.276	0.630	LWE-0813-1313-1-1
0.813	1.375	0.276	0.551	MLE-0813-1375-B-1
0.813	1.375	0.276	0.630	LWE-0813-1375-1-1
0.813	1.438	0.276	0.551	MLE-0813-1438-B-1
0.813	1.438	0.276	0.630	LWE-0813-1438-1-1
0.813	1.500	0.276	0.551	MLE-0813-1500-B-1
0.813	1.500	0.276	0.630	LWE-0813-1500-1-1
0.813	1.525	0.276	0.551	MLE-0813-1525-B-1
0.813	1.525	0.276	0.630	LWE-0813-1525-1-1
0.813	1.562	0.313	0.688	FSE-0813-1562-1-1
0.813	1.562	0.562	0.562	LNE-0813-1562-1-1
0.813	1.562	0.591	0.591	FNE-0813-1562-1-1
0.813	1.563	0.276	0.551	MLE-0813-1563-B-1
0.813	1.563	0.276	0.630	LWE-0813-1563-1-1
0.813	1.625	0.313	0.688	FSE-0813-1625-1-1
0.813	1.625	0.562	0.562	LNE-0813-1625-1-1
0.813	1.625	0.591	0.591	FNE-0813-1625-1-1
0.813	1.687	0.313	0.688	FSE-0813-1687-1-1
0.813	1.687	0.562	0.562	LNE-0813-1687-1-1
0.813	1.687	0.591	0.591	FNE-0813-1687-1-1
0.813	1.688	0.276	0.551	MLE-0813-1688-B-1
0.813	1.688	0.276	0.630	LWE-0813-1688-1-1
0.813	1.750	0.276	0.551	MLE-0813-1750-B-1
0.813	1.750	0.276	0.630	LWE-0813-1750-1-1
0.813	1.750	0.313	0.688	FSE-0813-1750-1-1
0.813	1.750	0.562	0.562	LNE-0813-1750-1-1
0.813	1.750	0.591	0.591	FNE-0813-1750-1-1
0.813	1.812	0.313	0.688	FSE-0813-1812-1-1

Shaft Dia.	Bore Dia.	Total In Bore Depth	Total Seal Width	ProTech Part Number
0.813	1.812	0.562	0.562	LNE-0813-1812-1-1
0.813	1.812	0.591	0.591	FNE-0813-1812-1-1
0.813	1.813	0.276	0.551	MLE-0813-1813-B-1
0.813	1.813	0.276	0.630	LWE-0813-1813-1-1
0.813	1.875	0.276	0.551	MLE-0813-1875-B-1
0.813	1.875	0.276	0.630	LWE-0813-1875-1-1
0.813	1.875	0.313	0.688	FSE-0813-1875-1-1
0.813	1.875	0.562	0.562	LNE-0813-1875-1-1
0.813	1.875	0.591	0.591	FNE-0813-1875-1-1
0.813	1.937	0.313	0.688	FSE-0813-1937-1-1
0.813	1.937	0.562	0.562	LNE-0813-1937-1-1
0.813	1.937	0.591	0.591	FNE-0813-1937-1-1
0.813	1.938	0.276	0.551	MLE-0813-1938-B-1
0.813	1.938	0.276	0.630	LWE-0813-1938-1-1
0.813	2.000	0.276	0.551	MLE-0813-2000-B-1
0.813	2.000	0.276	0.630	LWE-0813-2000-1-1
0.813	2.000	0.313	0.688	FSE-0813-2000-1-1
0.813	2.000	0.562	0.562	LNE-0813-2000-1-1
0.813	2.000	0.591	0.591	FNE-0813-2000-1-1
0.813	2.062	0.313	0.688	FSE-0813-2062-1-1
0.813	2.062	0.562	0.562	LNE-0813-2062-1-1
0.813	2.062	0.591	0.591	FNE-0813-2062-1-1
0.813	2.063	0.276	0.551	MLE-0813-2063-B-1
0.813	2.063	0.276	0.630	LWE-0813-2063-1-1
0.813	2.125	0.276	0.551	MLE-0813-2125-B-1
0.813	2.125	0.276	0.630	LWE-0813-2125-1-1
0.813	2.125	0.313	0.688	FSE-0813-2125-1-1
0.813	2.125	0.562	0.562	LNE-0813-2125-1-1
0.813	2.125	0.591	0.591	FNE-0813-2125-1-1
0.813	2.187	0.313	0.688	FSE-0813-2187-1-1
0.813	2.187	0.562	0.562	LNE-0813-2187-1-1
0.813	2.187	0.591	0.591	FNE-0813-2187-1-1
0.813	2.188	0.276	0.551	MLE-0813-2188-B-1
0.813	2.188	0.276	0.630	LWE-0813-2188-1-1
0.813	2.250	0.276	0.551	MLE-0813-2250-B-1
0.813	2.250	0.276	0.630	LWE-0813-2250-1-1
0.813	2.250	0.313	0.688	FSE-0813-2250-1-1
0.813	2.250	0.562	0.562	LNE-0813-2250-1-1
0.813	2.250	0.591	0.591	FNE-0813-2250-1-1
0.813	2.312	0.313	0.688	FSE-0813-2312-1-1
0.813	2.312	0.562	0.562	LNE-0813-2312-1-1
0.813	2.312	0.591	0.591	FNE-0813-2312-1-1
0.813	2.313	0.276	0.551	MLE-0813-2313-B-1
0.813	2.313	0.276	0.630	LWE-0813-2313-1-1
0.875	1.500	0.313	0.688	LSE-0875-1500-1-1
0.875	1.562	0.313	0.688	LSE-0875-1562-1-1
0.875	1.625	0.313	0.688	LSE-0875-1625-1-1
0.875	1.625	0.313	0.688	FSE-0875-1625-1-1
0.875	1.625	0.562	0.562	LNE-0875-1625-1-1
0.875	1.625	0.591	0.591	FNE-0875-1625-1-1
0.875	1.688	0.313	0.688	LSE-0875-1688-1-1
0.875	1.688	0.313	0.688	FSE-0875-1688-1-1
0.875	1.688	0.562	0.562	LNE-0875-1688-1-1
0.875	1.688	0.591	0.591	FNE-0875-1688-1-1
0.875	1.750	0.313	0.688	LSE-0875-1750-1-1
0.875	1.750	0.313	0.688	FSE-0875-1750-1-1
0.875	1.750	0.562	0.562	LNE-0875-1750-1-1
0.875	1.750	0.591	0.591	FNE-0875-1750-1-1
0.875	1.813	0.276	0.551	MLE-0875-1813-B-1
0.875	1.813	0.276	0.630	LWE-0875-1813-1-1
0.875	1.813	0.313	0.688	LSE-0875-1813-1-1
0.875	1.813	0.313	0.688	FSE-0875-1813-1-1
0.875	1.813	0.562	0.562	LNE-0875-1813-1-1
0.875	1.813	0.591	0.591	FNE-0875-1813-1-1
0.875	1.875	0.276	0.551	MLE-0875-1875-B-1
0.875	1.875	0.276	0.630	LWE-0875-1875-1-1

03/03/06

See Section 4 for seal part number prefix description.



0.875 to 0.938

Shaft Dia.	Bore Dia.	Total In Bore Depth	Total Seal Width	ProTech Part Number
0.875	1.875	0.313	0.688	LSE-0875-1875-1-1
0.875	1.875	0.313	0.688	FSE-0875-1875-1-1
0.875	1.875	0.562	0.562	LNE-0875-1875-1-1
0.875	1.875	0.591	0.591	FNE-0875-1875-1-1
0.875	1.938	0.276	0.551	MLE-0875-1938-B-1
0.875	1.938	0.276	0.630	LWE-0875-1938-1-1
0.875	1.938	0.313	0.688	LSE-0875-1938-1-1
0.875	1.938	0.313	0.688	FSE-0875-1938-1-1
0.875	1.938	0.562	0.562	LNE-0875-1938-1-1
0.875	1.938	0.591	0.591	FNE-0875-1938-1-1
0.875	2.000	0.276	0.551	MLE-0875-2000-B-1
0.875	2.000	0.276	0.630	LWE-0875-2000-1-1
0.875	2.000	0.313	0.688	LSE-0875-2000-1-1
0.875	2.000	0.313	0.688	FSE-0875-2000-1-1
0.875	2.000	0.562	0.562	LNE-0875-2000-1-1
0.875	2.000	0.591	0.591	FNE-0875-2000-1-1
0.875	2.062	0.313	0.688	LSE-0875-2062-1-1
0.875	2.062	0.313	0.688	FSE-0875-2062-1-1
0.875	2.062	0.562	0.562	LNE-0875-2062-1-1
0.875	2.062	0.591	0.591	FNE-0875-2062-1-1
0.875	2.063	0.276	0.551	MLE-0875-2063-B-1
0.875	2.063	0.276	0.630	LWE-0875-2063-1-1
0.875	2.125	0.276	0.551	MLE-0875-2125-B-1
0.875	2.125	0.276	0.630	LWE-0875-2125-1-1
0.875	2.125	0.313	0.688	LSE-0875-2125-1-1
0.875	2.125	0.313	0.688	FSE-0875-2125-1-1
0.875	2.125	0.562	0.562	LNE-0875-2125-1-1
0.875	2.125	0.591	0.591	FNE-0875-2125-1-1
0.875	2.188	0.276	0.551	MLE-0875-2188-B-1
0.875	2.188	0.276	0.630	LWE-0875-2188-1-1
0.875	2.188	0.313	0.688	LSE-0875-2188-1-1
0.875	2.188	0.313	0.688	FSE-0875-2188-1-1
0.875	2.188	0.562	0.562	LNE-0875-2188-1-1
0.875	2.188	0.591	0.591	FNE-0875-2188-1-1
0.875	2.250	0.313	0.688	LSE-0875-2250-1-1
0.875	2.250	0.313	0.688	FSE-0875-2250-1-1
0.875	2.250	0.562	0.562	LNE-0875-2250-1-1
0.875	2.250	0.591	0.591	FNE-0875-2250-1-1
0.875	2.312	0.313	0.688	LSE-0875-2312-1-1
0.875	2.312	0.313	0.688	FSE-0875-2312-1-1
0.875	2.312	0.562	0.562	LNE-0875-2312-1-1
0.875	2.312	0.591	0.591	FNE-0875-2312-1-1
0.875	2.375	0.313	0.688	LSE-0875-2375-1-1
0.875	2.375	0.313	0.688	FSE-0875-2375-1-1
0.875	2.375	0.562	0.562	LNE-0875-2375-1-1
0.875	2.375	0.591	0.591	FNE-0875-2375-1-1
0.938	1.438	0.276	0.551	MLE-0938-1438-B-1
0.938	1.438	0.276	0.630	LWE-0938-1438-1-1
0.938	1.500	0.276	0.551	MLE-0938-1500-B-1
0.938	1.500	0.276	0.630	LWE-0938-1500-1-1
0.938	1.563	0.276	0.551	MLE-0938-1563-B-1
0.938	1.563	0.276	0.630	LWE-0938-1563-1-1
0.938	1.563	0.313	0.688	LSE-0938-1563-1-1
0.938	1.625	0.276	0.551	MLE-0938-1625-B-1
0.938	1.625	0.276	0.630	LWE-0938-1625-1-1
0.938	1.625	0.313	0.688	LSE-0938-1625-1-1
0.938	1.688	0.276	0.551	MLE-0938-1688-B-1
0.938	1.688	0.276	0.630	LWE-0938-1688-1-1
0.938	1.688	0.313	0.688	LSE-0938-1688-1-1
0.938	1.688	0.313	0.688	FSE-0938-1688-1-1
0.938	1.688	0.562	0.562	LNE-0938-1688-1-1
0.938	1.688	0.591	0.591	FNE-0938-1688-1-1
0.938	1.750	0.276	0.551	MLE-0938-1750-B-1
0.938	1.750	0.276	0.630	LWE-0938-1750-1-1
0.938	1.750	0.313	0.688	LSE-0938-1750-1-1
0.938	1.750	0.313	0.688	FSE-0938-1750-1-1

Shaft Dia.	Bore Dia.	Total In Bore Depth	Total Seal Width	ProTech Part Number
0.938	1.750	0.562	0.562	LNE-0938-1750-1-1
0.938	1.750	0.591	0.591	FNE-0938-1750-1-1
0.938	1.813	0.276	0.551	MLE-0938-1813-B-1
0.938	1.813	0.276	0.630	LWE-0938-1813-1-1
0.938	1.813	0.313	0.688	LSE-0938-1813-1-1
0.938	1.813	0.313	0.688	FSE-0938-1813-1-1
0.938	1.813	0.562	0.562	LNE-0938-1813-1-1
0.938	1.813	0.591	0.591	FNE-0938-1813-1-1
0.938	1.875	0.276	0.551	MLE-0938-1875-B-1
0.938	1.875	0.276	0.630	LWE-0938-1875-1-1
0.938	1.875	0.313	0.688	LSE-0938-1875-1-1
0.938	1.875	0.313	0.688	FSE-0938-1875-1-1
0.938	1.875	0.562	0.562	LNE-0938-1875-1-1
0.938	1.875	0.591	0.591	FNE-0938-1875-1-1
0.938	1.938	0.276	0.551	MLE-0938-1938-B-1
0.938	1.938	0.276	0.630	LWE-0938-1938-1-1
0.938	1.938	0.313	0.688	LSE-0938-1938-1-1
0.938	1.938	0.313	0.688	FSE-0938-1938-1-1
0.938	1.938	0.562	0.562	LNE-0938-1938-1-1
0.938	1.938	0.591	0.591	FNE-0938-1938-1-1
0.938	2.000	0.276	0.551	MLE-0938-2000-B-1
0.938	2.000	0.276	0.630	LWE-0938-2000-1-1
0.938	2.000	0.313	0.688	LSE-0938-2000-1-1
0.938	2.000	0.313	0.688	FSE-0938-2000-1-1
0.938	2.000	0.562	0.562	LNE-0938-2000-1-1
0.938	2.000	0.591	0.591	FNE-0938-2000-1-1
0.938	2.063	0.276	0.551	MLE-0938-2063-B-1
0.938	2.063	0.276	0.630	LWE-0938-2063-1-1
0.938	2.063	0.313	0.688	LSE-0938-2063-1-1
0.938	2.063	0.313	0.688	FSE-0938-2063-1-1
0.938	2.063	0.562	0.562	LNE-0938-2063-1-1
0.938	2.063	0.591	0.591	FNE-0938-2063-1-1
0.938	2.125	0.276	0.551	MLE-0938-2125-B-1
0.938	2.125	0.276	0.630	LWE-0938-2125-1-1
0.938	2.125	0.313	0.688	LSE-0938-2125-1-1
0.938	2.125	0.313	0.688	FSE-0938-2125-1-1
0.938	2.125	0.562	0.562	LNE-0938-2125-1-1
0.938	2.125	0.591	0.591	FNE-0938-2125-1-1
0.938	2.188	0.276	0.551	MLE-0938-2188-B-1
0.938	2.188	0.276	0.630	LWE-0938-2188-1-1
0.938	2.188	0.313	0.688	LSE-0938-2188-1-1
0.938	2.188	0.313	0.688	FSE-0938-2188-1-1
0.938	2.188	0.562	0.562	LNE-0938-2188-1-1
0.938	2.188	0.591	0.591	FNE-0938-2188-1-1
0.938	2.250	0.276	0.551	MLE-0938-2250-B-1
0.938	2.250	0.276	0.630	LWE-0938-2250-1-1
0.938	2.250	0.313	0.688	LSE-0938-2250-1-1
0.938	2.250	0.313	0.688	FSE-0938-2250-1-1
0.938	2.250	0.562	0.562	LNE-0938-2250-1-1
0.938	2.250	0.591	0.591	FNE-0938-2250-1-1
0.938	2.313	0.276	0.551	MLE-0938-2313-B-1
0.938	2.313	0.276	0.630	LWE-0938-2313-1-1
0.938	2.313	0.313	0.688	LSE-0938-2313-1-1
0.938	2.313	0.313	0.688	FSE-0938-2313-1-1
0.938	2.313	0.562	0.562	LNE-0938-2313-1-1
0.938	2.313	0.591	0.591	FNE-0938-2313-1-1
0.938	2.375	0.276	0.551	MLE-0938-2375-B-1
0.938	2.375	0.276	0.630	LWE-0938-2375-1-1
0.938	2.375	0.313	0.688	LSE-0938-2375-1-1
0.938	2.375	0.313	0.688	FSE-0938-2375-1-1
0.938	2.375	0.562	0.562	LNE-0938-2375-1-1
0.938	2.375	0.591	0.591	FNE-0938-2375-1-1
0.938	2.438	0.276	0.551	MLE-0938-2438-B-1
0.938	2.438	0.276	0.630	LWE-0938-2438-1-1
0.938	2.438	0.313	0.688	LSE-0938-2438-1-1
0.938	2.438	0.313	0.688	FSE-0938-2438-1-1



See **Section 4** for seal part number prefix description.

03/03/06



Shaft Dia.	Bore Dia.	Total In Bore Depth	Total Seal Width	ProTech Part Number
0.938	2.438	0.562	0.562	LNE-0938-2438-1-1
0.938	2.438	0.591	0.591	FNE-0938-2438-1-1
1.000	1.500	0.276	0.551	MLE-1000-1500-B-1
1.000	1.500	0.276	0.630	LWE-1000-1500-1-1
1.000	1.563	0.276	0.551	MLE-1000-1563-B-1
1.000	1.563	0.276	0.630	LWE-1000-1563-1-1
1.000	1.625	0.276	0.551	MLE-1000-1625-B-1
1.000	1.625	0.276	0.630	LWE-1000-1625-1-1
1.000	1.625	0.313	0.688	LSE-1000-1625-1-1
1.000	1.688	0.276	0.551	MLE-1000-1688-B-1
1.000	1.688	0.276	0.630	LWE-1000-1688-1-1
1.000	1.688	0.313	0.688	LSE-1000-1688-1-1
1.000	1.750	0.276	0.551	MLE-1000-1750-B-1
1.000	1.750	0.276	0.630	LWE-1000-1750-1-1
1.000	1.750	0.313	0.688	LSE-1000-1750-1-1
1.000	1.750	0.313	0.688	FSE-1000-1750-1-1
1.000	1.750	0.562	0.562	LNE-1000-1750-1-1
1.000	1.750	0.591	0.591	FNE-1000-1750-1-1
1.000	1.813	0.276	0.551	MLE-1000-1813-B-1
1.000	1.813	0.276	0.630	LWE-1000-1813-1-1
1.000	1.813	0.313	0.688	LSE-1000-1813-1-1
1.000	1.875	0.276	0.551	MLE-1000-1875-B-1
1.000	1.875	0.276	0.630	LWE-1000-1875-1-1
1.000	1.875	0.313	0.688	LSE-1000-1875-1-1
1.000	1.938	0.276	0.551	MLE-1000-1938-B-1
1.000	1.938	0.276	0.630	LWE-1000-1938-1-1
1.000	1.938	0.313	0.688	LSE-1000-1938-1-1
1.000	1.938	0.313	0.688	FSE-1000-1938-1-1
1.000	1.938	0.562	0.562	LNE-1000-1938-1-1
1.000	1.938	0.591	0.591	FNE-1000-1938-1-1
1.000	2.000	0.276	0.551	MLE-1000-2000-B-1
1.000	2.000	0.276	0.630	LWE-1000-2000-1-1
1.000	2.000	0.313	0.688	LSE-1000-2000-1-1
1.000	2.000	0.313	0.688	FSE-1000-2000-1-1
1.000	2.000	0.562	0.562	LNE-1000-2000-1-1
1.000	2.000	0.591	0.591	FNE-1000-2000-1-1
1.000	2.062	0.313	0.688	LSE-1000-2062-1-1
1.000	2.062	0.313	0.688	FSE-1000-2062-1-1
1.000	2.062	0.562	0.562	LNE-1000-2062-1-1
1.000	2.062	0.591	0.591	FNE-1000-2062-1-1
1.000	2.063	0.276	0.551	MLE-1000-2063-B-1
1.000	2.063	0.276	0.630	LWE-1000-2063-1-1
1.000	2.125	0.276	0.551	MLE-1000-2125-B-1
1.000	2.125	0.276	0.630	LWE-1000-2125-1-1
1.000	2.125	0.313	0.688	LSE-1000-2125-1-1
1.000	2.125	0.313	0.688	FSE-1000-2125-1-1
1.000	2.125	0.562	0.562	LNE-1000-2125-1-1
1.000	2.125	0.591	0.591	FNE-1000-2125-1-1
1.000	2.188	0.276	0.551	MLE-1000-2188-B-1
1.000	2.188	0.276	0.630	LWE-1000-2188-1-1
1.000	2.188	0.313	0.688	LSE-1000-2188-1-1
1.000	2.188	0.313	0.688	FSE-1000-2188-1-1
1.000	2.188	0.562	0.562	LNE-1000-2188-1-1
1.000	2.188	0.591	0.591	FNE-1000-2188-1-1
1.000	2.250	0.276	0.551	MLE-1000-2250-B-1
1.000	2.250	0.276	0.630	LWE-1000-2250-1-1
1.000	2.250	0.313	0.688	LSE-1000-2250-1-1
1.000	2.250	0.313	0.688	FSE-1000-2250-1-1
1.000	2.250	0.562	0.562	LNE-1000-2250-1-1
1.000	2.250	0.591	0.591	FNE-1000-2250-1-1
1.000	2.312	0.313	0.688	LSE-1000-2312-1-1
1.000	2.312	0.313	0.688	FSE-1000-2312-1-1
1.000	2.312	0.562	0.562	LNE-1000-2312-1-1
1.000	2.312	0.591	0.591	FNE-1000-2312-1-1
1.000	2.313	0.276	0.551	MLE-1000-2313-B-1
1.000	2.313	0.276	0.630	LWE-1000-2313-1-1

Shaft Dia.	Bore Dia.	Total In Bore Depth	Total Seal Width	ProTech Part Number
1.000	2.375	0.276	0.551	MLE-1000-2375-B-1
1.000	2.375	0.276	0.630	LWE-1000-2375-1-1
1.000	2.375	0.313	0.688	LSE-1000-2375-1-1
1.000	2.375	0.313	0.688	FSE-1000-2375-1-1
1.000	2.375	0.562	0.562	LNE-1000-2375-1-1
1.000	2.375	0.591	0.591	FNE-1000-2375-1-1
1.000	2.438	0.276	0.551	MLE-1000-2438-B-1
1.000	2.438	0.276	0.630	LWE-1000-2438-1-1
1.000	2.438	0.313	0.688	LSE-1000-2438-1-1
1.000	2.438	0.313	0.688	FSE-1000-2438-1-1
1.000	2.438	0.562	0.562	LNE-1000-2438-1-1
1.000	2.438	0.591	0.591	FNE-1000-2438-1-1
1.000	2.500	0.276	0.551	MLE-1000-2500-B-1
1.000	2.500	0.276	0.630	LWE-1000-2500-1-1
1.000	2.500	0.313	0.688	LSE-1000-2500-1-1
1.000	2.500	0.313	0.688	FSE-1000-2500-1-1
1.000	2.500	0.562	0.562	LNE-1000-2500-1-1
1.000	2.500	0.591	0.591	FNE-1000-2500-1-1
1.062	1.687	0.313	0.688	LSE-1062-1687-1-1
1.062	1.750	0.313	0.688	LSE-1062-1750-1-1
1.062	1.812	0.313	0.688	LSE-1062-1812-1-1
1.062	1.875	0.313	0.688	LSE-1062-1875-1-1
1.062	1.937	0.313	0.688	LSE-1062-1937-1-1
1.062	2.000	0.313	0.688	LSE-1062-2000-1-1
1.062	2.062	0.313	0.688	LSE-1062-2062-1-1
1.062	2.125	0.313	0.688	LSE-1062-2125-1-1
1.062	2.187	0.313	0.688	LSE-1062-2187-1-1
1.062	2.250	0.313	0.688	LSE-1062-2250-1-1
1.062	2.312	0.313	0.688	LSE-1062-2312-1-1
1.062	2.375	0.313	0.688	LSE-1062-2375-1-1
1.062	2.437	0.313	0.688	LSE-1062-2437-1-1
1.062	2.500	0.313	0.688	LSE-1062-2500-1-1
1.062	2.562	0.313	0.688	LSE-1062-2562-1-1
1.063	1.563	0.276	0.551	MLE-1063-1563-B-1
1.063	1.563	0.276	0.630	LWE-1063-1563-1-1
1.063	1.625	0.276	0.551	MLE-1063-1625-B-1
1.063	1.625	0.276	0.630	LWE-1063-1625-1-1
1.063	1.688	0.276	0.551	MLE-1063-1688-B-1
1.063	1.688	0.276	0.630	LWE-1063-1688-1-1
1.063	1.750	0.276	0.551	MLE-1063-1750-B-1
1.063	1.750	0.276	0.630	LWE-1063-1750-1-1
1.063	1.812	0.313	0.688	FSE-1063-1812-1-1
1.063	1.812	0.562	0.562	LNE-1063-1812-1-1
1.063	1.812	0.591	0.591	FNE-1063-1812-1-1
1.063	1.813	0.276	0.551	MLE-1063-1813-B-1
1.063	1.813	0.276	0.630	LWE-1063-1813-1-1
1.063	1.875	0.276	0.551	MLE-1063-1875-B-1
1.063	1.875	0.276	0.630	LWE-1063-1875-1-1
1.063	1.875	0.313	0.688	FSE-1063-1875-1-1
1.063	1.875	0.562	0.562	LNE-1063-1875-1-1
1.063	1.875	0.591	0.591	FNE-1063-1875-1-1
1.063	1.938	0.276	0.551	MLE-1063-1938-B-1
1.063	1.938	0.276	0.630	LWE-1063-1938-1-1
1.063	1.938	0.313	0.688	FSE-1063-1938-1-1
1.063	1.938	0.562	0.562	LNE-1063-1938-1-1
1.063	1.938	0.591	0.591	FNE-1063-1938-1-1
1.063	2.000	0.276	0.551	MLE-1063-2000-B-1
1.063	2.000	0.276	0.630	LWE-1063-2000-1-1
1.063	2.000	0.313	0.688	FSE-1063-2000-1-1
1.063	2.000	0.562	0.562	LNE-1063-2000-1-1
1.063	2.000	0.591	0.591	FNE-1063-2000-1-1
1.063	2.063	0.276	0.551	MLE-1063-2063-B-1
1.063	2.063	0.276	0.630	LWE-1063-2063-1-1
1.063	2.063	0.313	0.688	FSE-1063-2063-1-1
1.063	2.063	0.562	0.562	LNE-1063-2063-1-1
1.063	2.063	0.591	0.591	FNE-1063-2063-1-1

F

See Section 4 for seal part number prefix description.

03/03/06



1.063 to 1.188

Shaft Dia.	Bore Dia.	Total In Bore Depth	Total Seal Width	ProTech Part Number
1.063	2.125	0.276	0.551	MLE-1063-2125-B-1
1.063	2.125	0.276	0.630	LWE-1063-2125-1-1
1.063	2.125	0.313	0.688	FSE-1063-2125-1-1
1.063	2.125	0.562	0.562	LNE-1063-2125-1-1
1.063	2.125	0.591	0.591	FNE-1063-2125-1-1
1.063	2.188	0.276	0.551	MLE-1063-2188-B-1
1.063	2.188	0.276	0.630	LWE-1063-2188-1-1
1.063	2.188	0.313	0.688	FSE-1063-2188-1-1
1.063	2.188	0.562	0.562	LNE-1063-2188-1-1
1.063	2.188	0.591	0.591	FNE-1063-2188-1-1
1.063	2.250	0.276	0.551	MLE-1063-2250-B-1
1.063	2.250	0.276	0.630	LWE-1063-2250-1-1
1.063	2.250	0.313	0.688	FSE-1063-2250-1-1
1.063	2.250	0.562	0.562	LNE-1063-2250-1-1
1.063	2.250	0.591	0.591	FNE-1063-2250-1-1
1.063	2.313	0.276	0.551	MLE-1063-2313-B-1
1.063	2.313	0.276	0.630	LWE-1063-2313-1-1
1.063	2.313	0.313	0.688	FSE-1063-2313-1-1
1.063	2.313	0.562	0.562	LNE-1063-2313-1-1
1.063	2.313	0.591	0.591	FNE-1063-2313-1-1
1.063	2.375	0.276	0.551	MLE-1063-2375-B-1
1.063	2.375	0.276	0.630	LWE-1063-2375-1-1
1.063	2.375	0.313	0.688	FSE-1063-2375-1-1
1.063	2.375	0.562	0.562	LNE-1063-2375-1-1
1.063	2.375	0.591	0.591	FNE-1063-2375-1-1
1.063	2.438	0.276	0.551	MLE-1063-2438-B-1
1.063	2.438	0.276	0.630	LWE-1063-2438-1-1
1.063	2.438	0.313	0.688	FSE-1063-2438-1-1
1.063	2.438	0.562	0.562	LNE-1063-2438-1-1
1.063	2.438	0.591	0.591	FNE-1063-2438-1-1
1.063	2.500	0.276	0.551	MLE-1063-2500-B-1
1.063	2.500	0.276	0.630	LWE-1063-2500-1-1
1.063	2.500	0.313	0.688	FSE-1063-2500-1-1
1.063	2.500	0.562	0.562	LNE-1063-2500-1-1
1.063	2.500	0.591	0.591	FNE-1063-2500-1-1
1.063	2.563	0.276	0.551	MLE-1063-2563-B-1
1.063	2.563	0.276	0.630	LWE-1063-2563-1-1
1.063	2.563	0.313	0.688	FSE-1063-2563-1-1
1.063	2.563	0.562	0.562	LNE-1063-2563-1-1
1.063	2.563	0.591	0.591	FNE-1063-2563-1-1
1.125	1.625	0.276	0.551	MLE-1125-1625-B-1
1.125	1.625	0.276	0.630	LWE-1125-1625-1-1
1.125	1.688	0.276	0.551	MLE-1125-1688-B-1
1.125	1.688	0.276	0.630	LWE-1125-1688-1-1
1.125	1.750	0.276	0.551	MLE-1125-1750-B-1
1.125	1.750	0.276	0.630	LWE-1125-1750-1-1
1.125	1.750	0.313	0.688	FSE-1125-1750-1-1
1.125	1.812	0.313	0.688	LSE-1125-1812-1-1
1.125	1.813	0.276	0.551	MLE-1125-1813-B-1
1.125	1.813	0.276	0.630	LWE-1125-1813-1-1
1.125	1.875	0.276	0.551	MLE-1125-1875-B-1
1.125	1.875	0.276	0.630	LWE-1125-1875-1-1
1.125	1.875	0.313	0.688	LSE-1125-1875-1-1
1.125	1.875	0.313	0.688	FSE-1125-1875-1-1
1.125	1.875	0.562	0.562	LNE-1125-1875-1-1
1.125	1.875	0.591	0.591	FNE-1125-1875-1-1
1.125	1.938	0.276	0.551	MLE-1125-1938-B-1
1.125	1.938	0.276	0.630	LWE-1125-1938-1-1
1.125	1.938	0.313	0.688	LSE-1125-1938-1-1
1.125	1.938	0.313	0.688	FSE-1125-1938-1-1
1.125	1.938	0.562	0.562	LNE-1125-1938-1-1
1.125	1.938	0.591	0.591	FNE-1125-1938-1-1
1.125	2.000	0.276	0.551	MLE-1125-2000-B-1
1.125	2.000	0.276	0.630	LWE-1125-2000-1-1
1.125	2.000	0.313	0.688	LSE-1125-2000-1-1
1.125	2.000	0.313	0.688	FSE-1125-2000-1-1

Shaft Dia.	Bore Dia.	Total In Bore Depth	Total Seal Width	ProTech Part Number
1.125	2.000	0.562	0.562	LNE-1125-2000-1-1
1.125	2.000	0.591	0.591	FNE-1125-2000-1-1
1.125	2.062	0.313	0.688	LSE-1125-2062-1-1
1.125	2.063	0.276	0.551	MLE-1125-2063-B-1
1.125	2.063	0.276	0.630	LWE-1125-2063-1-1
1.125	2.063	0.313	0.688	FSE-1125-2063-1-1
1.125	2.063	0.562	0.562	LNE-1125-2063-1-1
1.125	2.063	0.591	0.591	FNE-1125-2063-1-1
1.125	2.125	0.276	0.551	MLE-1125-2125-B-1
1.125	2.125	0.276	0.630	LWE-1125-2125-1-1
1.125	2.125	0.313	0.688	LSE-1125-2125-1-1
1.125	2.125	0.313	0.688	FSE-1125-2125-1-1
1.125	2.125	0.591	0.591	FNE-1125-2125-1-1
1.125	2.188	0.276	0.551	MLE-1125-2188-B-1
1.125	2.188	0.276	0.630	LWE-1125-2188-1-1
1.125	2.188	0.313	0.688	LSE-1125-2188-1-1
1.125	2.188	0.313	0.688	FSE-1125-2188-1-1
1.125	2.188	0.562	0.562	LNE-1125-2188-1-1
1.125	2.188	0.591	0.591	FNE-1125-2188-1-1
1.125	2.250	0.276	0.551	MLE-1125-2250-B-1
1.125	2.250	0.276	0.630	LWE-1125-2250-1-1
1.125	2.250	0.313	0.688	LSE-1125-2250-1-1
1.125	2.250	0.313	0.688	FSE-1125-2250-1-1
1.125	2.250	0.562	0.562	LNE-1125-2250-1-1
1.125	2.250	0.591	0.591	FNE-1125-2250-1-1
1.125	2.312	0.313	0.688	LSE-1125-2312-1-1
1.125	2.313	0.276	0.551	MLE-1125-2313-B-1
1.125	2.313	0.276	0.630	LWE-1125-2313-1-1
1.125	2.313	0.313	0.688	FSE-1125-2313-1-1
1.125	2.313	0.562	0.562	LNE-1125-2313-1-1
1.125	2.313	0.591	0.591	FNE-1125-2313-1-1
1.125	2.375	0.276	0.551	MLE-1125-2375-B-1
1.125	2.375	0.276	0.630	LWE-1125-2375-1-1
1.125	2.375	0.313	0.688	LSE-1125-2375-1-1
1.125	2.375	0.313	0.688	FSE-1125-2375-1-1
1.125	2.375	0.562	0.562	LNE-1125-2375-1-1
1.125	2.375	0.591	0.591	FNE-1125-2375-1-1
1.125	2.438	0.276	0.551	MLE-1125-2438-B-1
1.125	2.438	0.276	0.630	LWE-1125-2438-1-1
1.125	2.438	0.313	0.688	LSE-1125-2438-1-1
1.125	2.438	0.313	0.688	FSE-1125-2438-1-1
1.125	2.438	0.562	0.562	LNE-1125-2438-1-1
1.125	2.438	0.591	0.591	FNE-1125-2438-1-1
1.125	2.500	0.276	0.551	MLE-1125-2500-B-1
1.125	2.500	0.276	0.630	LWE-1125-2500-1-1
1.125	2.500	0.313	0.688	LSE-1125-2500-1-1
1.125	2.500	0.313	0.688	FSE-1125-2500-1-1
1.125	2.500	0.562	0.562	LNE-1125-2500-1-1
1.125	2.500	0.591	0.591	FNE-1125-2500-1-1
1.125	2.563	0.313	0.688	LSE-1125-2563-1-1
1.125	2.563	0.276	0.551	MLE-1125-2563-B-1
1.125	2.563	0.276	0.630	LWE-1125-2563-1-1
1.125	2.563	0.313	0.688	FSE-1125-2563-1-1
1.125	2.563	0.562	0.562	LNE-1125-2563-1-1
1.125	2.563	0.591	0.591	FNE-1125-2563-1-1
1.125	2.625	0.276	0.551	MLE-1125-2625-B-1
1.125	2.625	0.276	0.630	LWE-1125-2625-1-1
1.125	2.625	0.313	0.688	LSE-1125-2625-1-1
1.125	2.625	0.313	0.688	FSE-1125-2625-1-1
1.125	2.625	0.562	0.562	LNE-1125-2625-1-1
1.125	2.625	0.591	0.591	FNE-1125-2625-1-1
1.188	1.688	0.276	0.551	MLE-1188-1688-B-1
1.188	1.688	0.276	0.630	LWE-1188-1688-1-1
1.188	1.750	0.276	0.551	MLE-1188-1750-B-1
1.188	1.750	0.276	0.630	LWE-1188-1750-1-1



See **Section 4** for seal part number prefix description.

03/03/06



Shaft Dia.	Bore Dia.	Total In Bore Depth	Total Seal Width	ProTech Part Number
1.188	1.813	0.276	0.551	MLE-1188-1813-B-1
1.188	1.813	0.276	0.630	LWE-1188-1813-1-1
1.188	1.813	0.313	0.688	LSE-1188-1813-1-1
1.188	1.875	0.276	0.551	MLE-1188-1875-B-1
1.188	1.875	0.276	0.630	LWE-1188-1875-1-1
1.188	1.875	0.313	0.688	LSE-1188-1875-1-1
1.188	1.938	0.276	0.551	MLE-1188-1938-B-1
1.188	1.938	0.276	0.630	LWE-1188-1938-1-1
1.188	1.938	0.313	0.688	LSE-1188-1938-1-1
1.188	1.938	0.313	0.688	FSE-1188-1938-1-1
1.188	1.938	0.562	0.562	LNE-1188-1938-1-1
1.188	1.938	0.591	0.591	FNE-1188-1938-1-1
1.188	2.000	0.276	0.551	MLE-1188-2000-B-1
1.188	2.000	0.276	0.630	LWE-1188-2000-1-1
1.188	2.000	0.313	0.688	LSE-1188-2000-1-1
1.188	2.000	0.313	0.688	FSE-1188-2000-1-1
1.188	2.000	0.562	0.562	LNE-1188-2000-1-1
1.188	2.000	0.591	0.591	FNE-1188-2000-1-1
1.188	2.062	0.313	0.688	FSE-1188-2062-1-1
1.188	2.062	0.562	0.562	LNE-1188-2062-1-1
1.188	2.062	0.591	0.591	FNE-1188-2062-1-1
1.188	2.063	0.276	0.551	MLE-1188-2063-B-1
1.188	2.063	0.276	0.630	LWE-1188-2063-1-1
1.188	2.063	0.313	0.688	LSE-1188-2063-1-1
1.188	2.125	0.276	0.551	MLE-1188-2125-B-1
1.188	2.125	0.276	0.630	LWE-1188-2125-1-1
1.188	2.125	0.313	0.688	LSE-1188-2125-1-1
1.188	2.125	0.313	0.688	FSE-1188-2125-1-1
1.188	2.125	0.562	0.562	LNE-1188-2125-1-1
1.188	2.125	0.591	0.591	FNE-1188-2125-1-1
1.188	2.188	0.276	0.551	MLE-1188-2188-B-1
1.188	2.188	0.276	0.630	LWE-1188-2188-1-1
1.188	2.188	0.313	0.688	LSE-1188-2188-1-1
1.188	2.188	0.313	0.688	FSE-1188-2188-1-1
1.188	2.188	0.562	0.562	LNE-1188-2188-1-1
1.188	2.188	0.591	0.591	FNE-1188-2188-1-1
1.188	2.250	0.276	0.551	MLE-1188-2250-B-1
1.188	2.250	0.276	0.630	LWE-1188-2250-1-1
1.188	2.250	0.313	0.688	LSE-1188-2250-1-1
1.188	2.250	0.313	0.688	FSE-1188-2250-1-1
1.188	2.250	0.562	0.562	LNE-1188-2250-1-1
1.188	2.250	0.591	0.591	FNE-1188-2250-1-1
1.188	2.313	0.276	0.551	MLE-1188-2313-B-1
1.188	2.313	0.276	0.630	LWE-1188-2313-1-1
1.188	2.313	0.313	0.688	LSE-1188-2313-1-1
1.188	2.313	0.313	0.688	FSE-1188-2313-1-1
1.188	2.313	0.562	0.562	LNE-1188-2313-1-1
1.188	2.313	0.591	0.591	FNE-1188-2313-1-1
1.188	2.375	0.276	0.551	MLE-1188-2375-B-1
1.188	2.375	0.276	0.630	LWE-1188-2375-1-1
1.188	2.375	0.313	0.688	LSE-1188-2375-1-1
1.188	2.375	0.313	0.688	FSE-1188-2375-1-1
1.188	2.375	0.562	0.562	LNE-1188-2375-1-1
1.188	2.375	0.591	0.591	FNE-1188-2375-1-1
1.188	2.438	0.276	0.551	MLE-1188-2438-B-1
1.188	2.438	0.276	0.630	LWE-1188-2438-1-1
1.188	2.438	0.313	0.688	LSE-1188-2438-1-1
1.188	2.438	0.313	0.688	FSE-1188-2438-1-1
1.188	2.438	0.562	0.562	LNE-1188-2438-1-1
1.188	2.438	0.591	0.591	FNE-1188-2438-1-1
1.188	2.500	0.276	0.551	MLE-1188-2500-B-1
1.188	2.500	0.276	0.630	LWE-1188-2500-1-1
1.188	2.500	0.313	0.688	LSE-1188-2500-1-1
1.188	2.500	0.313	0.688	FSE-1188-2500-1-1
1.188	2.500	0.562	0.562	LNE-1188-2500-1-1
1.188	2.500	0.591	0.591	FNE-1188-2500-1-1

Shaft Dia.	Bore Dia.	Total In Bore Depth	Total Seal Width	ProTech Part Number
1.188	2.562	0.313	0.688	FSE-1188-2562-1-1
1.188	2.562	0.562	0.562	LNE-1188-2562-1-1
1.188	2.562	0.591	0.591	FNE-1188-2562-1-1
1.188	2.563	0.276	0.551	MLE-1188-2563-B-1
1.188	2.563	0.276	0.630	LWE-1188-2563-1-1
1.188	2.563	0.313	0.688	LSE-1188-2563-1-1
1.188	2.625	0.276	0.551	MLE-1188-2625-B-1
1.188	2.625	0.276	0.630	LWE-1188-2625-1-1
1.188	2.625	0.313	0.688	LSE-1188-2625-1-1
1.188	2.625	0.313	0.688	FSE-1188-2625-1-1
1.188	2.625	0.562	0.562	LNE-1188-2625-1-1
1.188	2.625	0.591	0.591	FNE-1188-2625-1-1
1.188	2.688	0.276	0.551	MLE-1188-2688-B-1
1.188	2.688	0.276	0.630	LWE-1188-2688-1-1
1.188	2.688	0.313	0.688	LSE-1188-2688-1-1
1.188	2.688	0.313	0.688	FSE-1188-2688-1-1
1.188	2.688	0.562	0.562	LNE-1188-2688-1-1
1.188	2.688	0.591	0.591	FNE-1188-2688-1-1
1.250	1.750	0.276	0.551	MLE-1250-1750-B-1
1.250	1.750	0.276	0.630	LWE-1250-1750-1-1
1.250	1.813	0.276	0.551	MLE-1250-1813-B-1
1.250	1.813	0.276	0.630	LWE-1250-1813-1-1
1.250	1.875	0.276	0.551	MLE-1250-1875-B-1
1.250	1.875	0.276	0.630	LWE-1250-1875-1-1
1.250	1.875	0.313	0.688	LSE-1250-1875-1-1
1.250	1.938	0.276	0.551	MLE-1250-1938-B-1
1.250	1.938	0.276	0.630	LWE-1250-1938-1-1
1.250	1.938	0.313	0.688	LSE-1250-1938-1-1
1.250	2.000	0.276	0.551	MLE-1250-2000-B-1
1.250	2.000	0.276	0.630	LWE-1250-2000-1-1
1.250	2.000	0.313	0.688	LSE-1250-2000-1-1
1.250	2.000	0.313	0.688	FSE-1250-2000-1-1
1.250	2.000	0.562	0.562	LNE-1250-2000-1-1
1.250	2.000	0.591	0.591	FNE-1250-2000-1-1
1.250	2.062	0.313	0.688	LSE-1250-2062-1-1
1.250	2.063	0.276	0.551	MLE-1250-2063-B-1
1.250	2.063	0.276	0.630	LWE-1250-2063-1-1
1.250	2.063	0.313	0.688	FSE-1250-2063-1-1
1.250	2.063	0.562	0.562	LNE-1250-2063-1-1
1.250	2.063	0.591	0.591	FNE-1250-2063-1-1
1.250	2.125	0.276	0.551	MLE-1250-2125-B-1
1.250	2.125	0.276	0.630	LWE-1250-2125-1-1
1.250	2.125	0.313	0.688	LSE-1250-2125-1-1
1.250	2.125	0.313	0.688	FSE-1250-2125-1-1
1.250	2.125	0.562	0.562	LNE-1250-2125-1-1
1.250	2.125	0.591	0.591	FNE-1250-2125-1-1
1.250	2.125	0.591	0.591	FNE-1250-2125-1-1
1.250	2.188	0.276	0.551	MLE-1250-2188-B-1
1.250	2.188	0.276	0.630	LWE-1250-2188-1-1
1.250	2.188	0.313	0.688	LSE-1250-2188-1-1
1.250	2.188	0.313	0.688	FSE-1250-2188-1-1
1.250	2.188	0.562	0.562	LNE-1250-2188-1-1
1.250	2.188	0.591	0.591	FNE-1250-2188-1-1
1.250	2.250	0.276	0.551	MLE-1250-2250-B-1
1.250	2.250	0.276	0.630	LWE-1250-2250-1-1
1.250	2.250	0.313	0.688	LSE-1250-2250-1-1
1.250	2.250	0.313	0.688	FSE-1250-2250-1-1
1.250	2.250	0.562	0.562	LNE-1250-2250-1-1
1.250	2.250	0.591	0.591	FNE-1250-2250-1-1
1.250	2.312	0.313	0.688	LSE-1250-2312-1-1
1.250	2.313	0.276	0.551	MLE-1250-2313-B-1
1.250	2.313	0.276	0.630	LWE-1250-2313-1-1
1.250	2.313	0.313	0.688	FSE-1250-2313-1-1
1.250	2.313	0.562	0.562	LNE-1250-2313-1-1
1.250	2.313	0.591	0.591	FNE-1250-2313-1-1
1.250	2.313	0.591	0.591	FNE-1250-2313-1-1
1.250	2.375	0.276	0.551	MLE-1250-2375-B-1
1.250	2.375	0.276	0.630	LWE-1250-2375-1-1

See Section 4 for seal part number prefix description.

03/03/06



1.250 to 1.375

Shaft Dia.	Bore Dia.	Total In Bore Depth	Total Seal Width	ProTech Part Number
1.250	2.375	0.313	0.688	LSE-1250-2375-1-1
1.250	2.375	0.313	0.688	FSE-1250-2375-1-1
1.250	2.375	0.562	0.562	LNE-1250-2375-1-1
1.250	2.375	0.591	0.591	FNE-1250-2375-1-1
1.250	2.437	0.313	0.688	LSE-1250-2437-1-1
1.250	2.438	0.313	0.688	FSE-1250-2438-1-1
1.250	2.438	0.562	0.562	LNE-1250-2438-1-1
1.250	2.438	0.591	0.591	FNE-1250-2438-1-1
1.250	2.500	0.276	0.551	MLE-1250-2500-B-1
1.250	2.500	0.276	0.630	LWE-1250-2500-1-1
1.250	2.500	0.313	0.688	LSE-1250-2500-1-1
1.250	2.500	0.313	0.688	FSE-1250-2500-1-1
1.250	2.500	0.562	0.562	LNE-1250-2500-1-1
1.250	2.500	0.591	0.591	FNE-1250-2500-1-1
1.250	2.562	0.313	0.688	LSE-1250-2562-1-1
1.250	2.563	0.313	0.688	FSE-1250-2563-1-1
1.250	2.563	0.562	0.562	LNE-1250-2563-1-1
1.250	2.563	0.591	0.591	FNE-1250-2563-1-1
1.250	2.625	0.276	0.551	MLE-1250-2625-B-1
1.250	2.625	0.276	0.630	LWE-1250-2625-1-1
1.250	2.625	0.313	0.688	LSE-1250-2625-1-1
1.250	2.625	0.313	0.688	FSE-1250-2625-1-1
1.250	2.625	0.562	0.562	LNE-1250-2625-1-1
1.250	2.625	0.591	0.591	FNE-1250-2625-1-1
1.250	2.688	0.313	0.688	LSE-1250-2688-1-1
1.250	2.688	0.313	0.688	FSE-1250-2688-1-1
1.250	2.688	0.562	0.562	LNE-1250-2688-1-1
1.250	2.688	0.591	0.591	FNE-1250-2688-1-1
1.250	2.750	0.276	0.551	MLE-1250-2750-B-1
1.250	2.750	0.276	0.630	LWE-1250-2750-1-1
1.250	2.750	0.313	0.688	LSE-1250-2750-1-1
1.250	2.750	0.313	0.688	FSE-1250-2750-1-1
1.250	2.750	0.562	0.562	LNE-1250-2750-1-1
1.250	2.750	0.591	0.591	FNE-1250-2750-1-1
1.313	1.813	0.276	0.551	MLE-1313-1813-B-1
1.313	1.813	0.276	0.630	LWE-1313-1813-1-1
1.313	1.875	0.276	0.551	MLE-1313-1875-B-1
1.313	1.875	0.276	0.630	LWE-1313-1875-1-1
1.313	1.938	0.276	0.551	MLE-1313-1938-B-1
1.313	1.938	0.276	0.630	LWE-1313-1938-1-1
1.313	1.938	0.313	0.688	LSE-1313-1938-1-1
1.313	2.000	0.276	0.551	MLE-1313-2000-B-1
1.313	2.000	0.276	0.630	LWE-1313-2000-1-1
1.313	2.000	0.313	0.688	LSE-1313-2000-1-1
1.313	2.000	0.313	0.688	FSE-1313-2000-1-1
1.313	2.000	0.562	0.562	LNE-1313-2000-1-1
1.313	2.000	0.591	0.591	FNE-1313-2000-1-1
1.313	2.063	0.276	0.551	MLE-1313-2063-B-1
1.313	2.063	0.276	0.630	LWE-1313-2063-1-1
1.313	2.063	0.313	0.688	LSE-1313-2063-1-1
1.313	2.063	0.313	0.688	FSE-1313-2063-1-1
1.313	2.063	0.562	0.562	LNE-1313-2063-1-1
1.313	2.063	0.591	0.591	FNE-1313-2063-1-1
1.313	2.125	0.276	0.551	MLE-1313-2125-B-1
1.313	2.125	0.276	0.630	LWE-1313-2125-1-1
1.313	2.125	0.313	0.688	LSE-1313-2125-1-1
1.313	2.125	0.313	0.688	FSE-1313-2125-1-1
1.313	2.125	0.562	0.562	LNE-1313-2125-1-1
1.313	2.125	0.591	0.591	FNE-1313-2125-1-1
1.313	2.188	0.276	0.551	MLE-1313-2188-B-1
1.313	2.188	0.276	0.630	LWE-1313-2188-1-1
1.313	2.188	0.313	0.688	LSE-1313-2188-1-1
1.313	2.188	0.313	0.688	FSE-1313-2188-1-1
1.313	2.188	0.562	0.562	LNE-1313-2188-1-1
1.313	2.188	0.591	0.591	FNE-1313-2188-1-1
1.313	2.250	0.276	0.551	MLE-1313-2250-B-1

Shaft Dia.	Bore Dia.	Total In Bore Depth	Total Seal Width	ProTech Part Number
1.313	2.250	0.276	0.630	LWE-1313-2250-1-1
1.313	2.250	0.313	0.688	LSE-1313-2250-1-1
1.313	2.250	0.313	0.688	FSE-1313-2250-1-1
1.313	2.250	0.562	0.562	LNE-1313-2250-1-1
1.313	2.250	0.591	0.591	FNE-1313-2250-1-1
1.313	2.313	0.276	0.551	MLE-1313-2313-B-1
1.313	2.313	0.276	0.630	LWE-1313-2313-1-1
1.313	2.313	0.313	0.688	LSE-1313-2313-1-1
1.313	2.313	0.313	0.688	FSE-1313-2313-1-1
1.313	2.313	0.562	0.562	LNE-1313-2313-1-1
1.313	2.313	0.591	0.591	FNE-1313-2313-1-1
1.313	2.375	0.276	0.551	MLE-1313-2375-B-1
1.313	2.375	0.276	0.630	LWE-1313-2375-1-1
1.313	2.375	0.313	0.688	LSE-1313-2375-1-1
1.313	2.375	0.313	0.688	FSE-1313-2375-1-1
1.313	2.375	0.562	0.562	LNE-1313-2375-1-1
1.313	2.375	0.591	0.591	FNE-1313-2375-1-1
1.313	2.438	0.276	0.551	MLE-1313-2438-B-1
1.313	2.438	0.276	0.630	LWE-1313-2438-1-1
1.313	2.438	0.313	0.688	LSE-1313-2438-1-1
1.313	2.438	0.313	0.688	FSE-1313-2438-1-1
1.313	2.438	0.562	0.562	LNE-1313-2438-1-1
1.313	2.438	0.591	0.591	FNE-1313-2438-1-1
1.313	2.500	0.276	0.551	MLE-1313-2500-B-1
1.313	2.500	0.276	0.630	LWE-1313-2500-1-1
1.313	2.500	0.313	0.688	LSE-1313-2500-1-1
1.313	2.500	0.313	0.688	FSE-1313-2500-1-1
1.313	2.500	0.562	0.562	LNE-1313-2500-1-1
1.313	2.500	0.591	0.591	FNE-1313-2500-1-1
1.313	2.563	0.276	0.551	MLE-1313-2563-B-1
1.313	2.563	0.276	0.630	LWE-1313-2563-1-1
1.313	2.563	0.313	0.688	LSE-1313-2563-1-1
1.313	2.563	0.313	0.688	FSE-1313-2563-1-1
1.313	2.563	0.562	0.562	LNE-1313-2563-1-1
1.313	2.563	0.591	0.591	FNE-1313-2563-1-1
1.313	2.625	0.276	0.551	MLE-1313-2625-B-1
1.313	2.625	0.276	0.630	LWE-1313-2625-1-1
1.313	2.625	0.313	0.688	LSE-1313-2625-1-1
1.313	2.625	0.313	0.688	FSE-1313-2625-1-1
1.313	2.625	0.562	0.562	LNE-1313-2625-1-1
1.313	2.625	0.591	0.591	FNE-1313-2625-1-1
1.313	2.688	0.276	0.551	MLE-1313-2688-B-1
1.313	2.688	0.276	0.630	LWE-1313-2688-1-1
1.313	2.688	0.313	0.688	LSE-1313-2688-1-1
1.313	2.688	0.313	0.688	FSE-1313-2688-1-1
1.313	2.688	0.562	0.562	LNE-1313-2688-1-1
1.313	2.688	0.591	0.591	FNE-1313-2688-1-1
1.313	2.750	0.276	0.551	MLE-1313-2750-B-1
1.313	2.750	0.276	0.630	LWE-1313-2750-1-1
1.313	2.750	0.313	0.688	LSE-1313-2750-1-1
1.313	2.750	0.313	0.688	FSE-1313-2750-1-1
1.313	2.750	0.562	0.562	LNE-1313-2750-1-1
1.313	2.750	0.591	0.591	FNE-1313-2750-1-1
1.313	2.813	0.276	0.551	MLE-1313-2813-B-1
1.313	2.813	0.276	0.630	LWE-1313-2813-1-1
1.313	2.813	0.313	0.688	LSE-1313-2813-1-1
1.313	2.813	0.313	0.688	FSE-1313-2813-1-1
1.313	2.813	0.562	0.562	LNE-1313-2813-1-1
1.313	2.813	0.591	0.591	FNE-1313-2813-1-1
1.375	1.875	0.276	0.551	MLE-1375-1875-B-1
1.375	1.875	0.276	0.630	LWE-1375-1875-1-1
1.375	1.938	0.276	0.551	MLE-1375-1938-B-1
1.375	1.938	0.276	0.630	LWE-1375-1938-1-1
1.375	2.000	0.276	0.551	MLE-1375-2000-B-1
1.375	2.000	0.276	0.630	LWE-1375-2000-1-1
1.375	2.000	0.313	0.688	LSE-1375-2000-1-1



03/03/06

See **Section 4** for seal part number prefix description.



Shaft Dia.	Bore Dia.	Total In Bore Depth	Total Seal Width	ProTech Part Number
1.375	2.062	0.313	0.688	LSE-1375-2062-1-1
1.375	2.063	0.276	0.551	MLE-1375-2063-B-1
1.375	2.063	0.276	0.630	LWE-1375-2063-1-1
1.375	2.125	0.276	0.551	MLE-1375-2125-B-1
1.375	2.125	0.276	0.630	LWE-1375-2125-1-1
1.375	2.125	0.313	0.688	LSE-1375-2125-1-1
1.375	2.125	0.313	0.688	FSE-1375-2125-1-1
1.375	2.125	0.562	0.562	LNE-1375-2125-1-1
1.375	2.125	0.591	0.591	FNE-1375-2125-1-1
1.375	2.188	0.313	0.688	LSE-1375-2188-1-1
1.375	2.188	0.313	0.688	FSE-1375-2188-1-1
1.375	2.188	0.562	0.562	LNE-1375-2188-1-1
1.375	2.188	0.591	0.591	FNE-1375-2188-1-1
1.375	2.250	0.276	0.551	MLE-1375-2250-B-1
1.375	2.250	0.276	0.630	LWE-1375-2250-1-1
1.375	2.250	0.313	0.688	LSE-1375-2250-1-1
1.375	2.312	0.313	0.688	LSE-1375-2312-1-1
1.375	2.375	0.276	0.551	MLE-1375-2375-B-1
1.375	2.375	0.276	0.630	LWE-1375-2375-1-1
1.375	2.375	0.313	0.688	LSE-1375-2375-1-1
1.375	2.438	0.313	0.688	LSE-1375-2438-1-1
1.375	2.500	0.276	0.551	MLE-1375-2500-B-1
1.375	2.500	0.276	0.630	LWE-1375-2500-1-1
1.375	2.500	0.313	0.688	LSE-1375-2500-1-1
1.375	2.500	0.313	0.688	FSE-1375-2500-1-1
1.375	2.500	0.562	0.562	LNE-1375-2500-1-1
1.375	2.500	0.591	0.591	FNE-1375-2500-1-1
1.375	2.562	0.313	0.688	LSE-1375-2562-1-1
1.375	2.563	0.313	0.688	FSE-1375-2563-1-1
1.375	2.563	0.562	0.562	LNE-1375-2563-1-1
1.375	2.563	0.591	0.591	FNE-1375-2563-1-1
1.375	2.625	0.276	0.551	MLE-1375-2625-B-1
1.375	2.625	0.276	0.630	LWE-1375-2625-1-1
1.375	2.625	0.313	0.688	LSE-1375-2625-1-1
1.375	2.625	0.313	0.688	FSE-1375-2625-1-1
1.375	2.625	0.562	0.562	LNE-1375-2625-1-1
1.375	2.625	0.591	0.591	FNE-1375-2625-1-1
1.375	2.688	0.313	0.688	LSE-1375-2688-1-1
1.375	2.688	0.313	0.688	FSE-1375-2688-1-1
1.375	2.688	0.562	0.562	LNE-1375-2688-1-1
1.375	2.688	0.591	0.591	FNE-1375-2688-1-1
1.375	2.750	0.276	0.551	MLE-1375-2750-B-1
1.375	2.750	0.276	0.630	LWE-1375-2750-1-1
1.375	2.750	0.313	0.688	LSE-1375-2750-1-1
1.375	2.750	0.313	0.688	FSE-1375-2750-1-1
1.375	2.750	0.562	0.562	LNE-1375-2750-1-1
1.375	2.750	0.591	0.591	FNE-1375-2750-1-1
1.375	2.812	0.313	0.688	LSE-1375-2812-1-1
1.375	2.813	0.276	0.551	MLE-1375-2813-B-1
1.375	2.813	0.276	0.630	LWE-1375-2813-1-1
1.375	2.813	0.313	0.688	FSE-1375-2813-1-1
1.375	2.813	0.313	0.688	LNE-1375-2813-1-1
1.375	2.813	0.591	0.591	FNE-1375-2813-1-1
1.375	2.875	0.276	0.551	MLE-1375-2875-B-1
1.375	2.875	0.276	0.630	LWE-1375-2875-1-1
1.375	2.875	0.313	0.688	LSE-1375-2875-1-1
1.375	2.875	0.313	0.688	FSE-1375-2875-1-1
1.375	2.875	0.562	0.562	LNE-1375-2875-1-1
1.375	2.875	0.591	0.591	FNE-1375-2875-1-1
1.438	1.938	0.276	0.551	MLE-1438-1938-B-1
1.438	1.938	0.276	0.630	LWE-1438-1938-1-1
1.438	2.000	0.276	0.551	MLE-1438-2000-B-1
1.438	2.000	0.276	0.630	LWE-1438-2000-1-1
1.438	2.063	0.276	0.551	MLE-1438-2063-B-1
1.438	2.063	0.276	0.630	LWE-1438-2063-1-1
1.438	2.063	0.313	0.688	LSE-1438-2063-1-1

Shaft Dia.	Bore Dia.	Total In Bore Depth	Total Seal Width	ProTech Part Number
1.438	2.125	0.276	0.551	MLE-1438-2125-B-1
1.438	2.125	0.276	0.630	LWE-1438-2125-1-1
1.438	2.125	0.313	0.688	LSE-1438-2125-1-1
1.438	2.188	0.276	0.551	MLE-1438-2188-B-1
1.438	2.188	0.276	0.630	LWE-1438-2188-1-1
1.438	2.188	0.313	0.688	LSE-1438-2188-1-1
1.438	2.188	0.313	0.688	FSE-1438-2188-1-1
1.438	2.188	0.562	0.562	LNE-1438-2188-1-1
1.438	2.188	0.591	0.591	FNE-1438-2188-1-1
1.438	2.250	0.276	0.551	MLE-1438-2250-B-1
1.438	2.250	0.276	0.630	LWE-1438-2250-1-1
1.438	2.250	0.313	0.688	LSE-1438-2250-1-1
1.438	2.250	0.313	0.688	FSE-1438-2250-1-1
1.438	2.250	0.562	0.562	LNE-1438-2250-1-1
1.438	2.250	0.591	0.591	FNE-1438-2250-1-1
1.438	2.313	0.276	0.551	MLE-1438-2313-B-1
1.438	2.313	0.276	0.630	LWE-1438-2313-1-1
1.438	2.313	0.313	0.688	LSE-1438-2313-1-1
1.438	2.313	0.313	0.688	FSE-1438-2313-1-1
1.438	2.313	0.562	0.562	LNE-1438-2313-1-1
1.438	2.313	0.591	0.591	FNE-1438-2313-1-1
1.438	2.375	0.276	0.551	MLE-1438-2375-B-1
1.438	2.375	0.276	0.630	LWE-1438-2375-1-1
1.438	2.375	0.313	0.688	LSE-1438-2375-1-1
1.438	2.375	0.313	0.688	FSE-1438-2375-1-1
1.438	2.375	0.562	0.562	LNE-1438-2375-1-1
1.438	2.375	0.591	0.591	FNE-1438-2375-1-1
1.438	2.438	0.276	0.551	MLE-1438-2438-B-1
1.438	2.438	0.276	0.630	LWE-1438-2438-1-1
1.438	2.438	0.313	0.688	LSE-1438-2438-1-1
1.438	2.438	0.313	0.688	FSE-1438-2438-1-1
1.438	2.438	0.562	0.562	LNE-1438-2438-1-1
1.438	2.438	0.591	0.591	FNE-1438-2438-1-1
1.438	2.500	0.276	0.551	MLE-1438-2500-B-1
1.438	2.500	0.276	0.630	LWE-1438-2500-1-1
1.438	2.500	0.313	0.688	LSE-1438-2500-1-1
1.438	2.500	0.313	0.688	FSE-1438-2500-1-1
1.438	2.500	0.562	0.562	LNE-1438-2500-1-1
1.438	2.500	0.591	0.591	FNE-1438-2500-1-1
1.438	2.563	0.276	0.551	MLE-1438-2563-B-1
1.438	2.563	0.276	0.630	LWE-1438-2563-1-1
1.438	2.563	0.313	0.688	LSE-1438-2563-1-1
1.438	2.563	0.313	0.688	FSE-1438-2563-1-1
1.438	2.563	0.562	0.562	LNE-1438-2563-1-1
1.438	2.563	0.591	0.591	FNE-1438-2563-1-1
1.438	2.625	0.276	0.551	MLE-1438-2625-B-1
1.438	2.625	0.276	0.630	LWE-1438-2625-1-1
1.438	2.625	0.313	0.688	LSE-1438-2625-1-1
1.438	2.625	0.313	0.688	FSE-1438-2625-1-1
1.438	2.625	0.562	0.562	LNE-1438-2625-1-1
1.438	2.625	0.591	0.591	FNE-1438-2625-1-1
1.438	2.688	0.276	0.551	MLE-1438-2688-B-1
1.438	2.688	0.276	0.630	LWE-1438-2688-1-1
1.438	2.688	0.313	0.688	LSE-1438-2688-1-1
1.438	2.688	0.313	0.688	FSE-1438-2688-1-1
1.438	2.688	0.562	0.562	LNE-1438-2688-1-1
1.438	2.688	0.591	0.591	FNE-1438-2688-1-1
1.438	2.750	0.276	0.551	MLE-1438-2750-B-1
1.438	2.750	0.276	0.630	LWE-1438-2750-1-1
1.438	2.750	0.313	0.688	LSE-1438-2750-1-1
1.438	2.750	0.313	0.688	FSE-1438-2750-1-1
1.438	2.750	0.562	0.562	LNE-1438-2750-1-1
1.438	2.750	0.591	0.591	FNE-1438-2750-1-1
1.438	2.813	0.276	0.551	MLE-1438-2813-B-1
1.438	2.813	0.276	0.630	LWE-1438-2813-1-1
1.438	2.813	0.313	0.688	LSE-1438-2813-1-1

See Section 4 for seal part number prefix description.

03/03/06



1.438 to 1.563

Shaft Dia.	Bore Dia.	Total In Bore Depth	Total Seal Width	ProTech Part Number
1.438	2.813	0.313	0.688	FSE-1438-2813-1-1
1.438	2.813	0.562	0.562	LNE-1438-2813-1-1
1.438	2.813	0.591	0.591	FNE-1438-2813-1-1
1.438	2.875	0.276	0.551	MLE-1438-2875-B-1
1.438	2.875	0.276	0.630	LWE-1438-2875-1-1
1.438	2.875	0.313	0.688	LSE-1438-2875-1-1
1.438	2.875	0.313	0.688	FSE-1438-2875-1-1
1.438	2.875	0.562	0.562	LNE-1438-2875-1-1
1.438	2.875	0.591	0.591	FNE-1438-2875-1-1
1.438	2.938	0.276	0.551	MLE-1438-2938-B-1
1.438	2.938	0.276	0.630	LWE-1438-2938-1-1
1.438	2.938	0.313	0.688	LSE-1438-2938-1-1
1.438	2.938	0.313	0.688	FSE-1438-2938-1-1
1.438	2.938	0.562	0.562	LNE-1438-2938-1-1
1.438	2.938	0.591	0.591	FNE-1438-2938-1-1
1.500	2.000	0.276	0.551	MLE-1500-2000-B-1
1.500	2.000	0.276	0.630	LWE-1500-2000-1-1
1.500	2.063	0.276	0.551	MLE-1500-2063-B-1
1.500	2.063	0.276	0.630	LWE-1500-2063-1-1
1.500	2.125	0.276	0.551	MLE-1500-2125-B-1
1.500	2.125	0.276	0.630	LWE-1500-2125-1-1
1.500	2.125	0.313	0.688	LSE-1500-2125-1-1
1.500	2.188	0.276	0.551	MLE-1500-2188-B-1
1.500	2.188	0.276	0.630	LWE-1500-2188-1-1
1.500	2.188	0.313	0.688	LSE-1500-2188-1-1
1.500	2.250	0.276	0.551	MLE-1500-2250-B-1
1.500	2.250	0.276	0.630	LWE-1500-2250-1-1
1.500	2.250	0.313	0.688	LSE-1500-2250-1-1
1.500	2.250	0.313	0.688	FSE-1500-2250-1-1
1.500	2.250	0.562	0.562	LNE-1500-2250-1-1
1.500	2.250	0.591	0.591	FNE-1500-2250-1-1
1.500	2.313	0.276	0.551	MLE-1500-2313-B-1
1.500	2.313	0.276	0.630	LWE-1500-2313-1-1
1.500	2.313	0.313	0.688	LSE-1500-2313-1-1
1.500	2.313	0.313	0.688	FSE-1500-2313-1-1
1.500	2.313	0.562	0.562	LNE-1500-2313-1-1
1.500	2.313	0.591	0.591	FNE-1500-2313-1-1
1.500	2.375	0.276	0.551	MLE-1500-2375-B-1
1.500	2.375	0.276	0.630	LWE-1500-2375-1-1
1.500	2.375	0.313	0.688	LSE-1500-2375-1-1
1.500	2.375	0.562	0.562	LNE-1500-2375-1-1
1.500	2.375	0.591	0.591	FNE-1500-2375-1-1
1.500	2.438	0.276	0.551	MLE-1500-2438-B-1
1.500	2.438	0.276	0.630	LWE-1500-2438-1-1
1.500	2.438	0.313	0.688	LSE-1500-2438-1-1
1.500	2.438	0.313	0.688	FSE-1500-2438-1-1
1.500	2.438	0.562	0.562	LNE-1500-2438-1-1
1.500	2.438	0.591	0.591	FNE-1500-2438-1-1
1.500	2.500	0.276	0.551	MLE-1500-2500-B-1
1.500	2.500	0.276	0.630	LWE-1500-2500-1-1
1.500	2.500	0.313	0.688	LSE-1500-2500-1-1
1.500	2.500	0.313	0.688	FSE-1500-2500-1-1
1.500	2.500	0.562	0.562	LNE-1500-2500-1-1
1.500	2.500	0.591	0.591	FNE-1500-2500-1-1
1.500	2.563	0.276	0.551	MLE-1500-2563-B-1
1.500	2.563	0.276	0.630	LWE-1500-2563-1-1
1.500	2.563	0.313	0.688	LSE-1500-2563-1-1
1.500	2.563	0.313	0.688	FSE-1500-2563-1-1
1.500	2.563	0.562	0.562	LNE-1500-2563-1-1
1.500	2.563	0.591	0.591	FNE-1500-2563-1-1
1.500	2.625	0.276	0.551	MLE-1500-2625-B-1
1.500	2.625	0.276	0.630	LWE-1500-2625-1-1
1.500	2.625	0.313	0.688	LSE-1500-2625-1-1
1.500	2.625	0.313	0.688	FSE-1500-2625-1-1
1.500	2.625	0.562	0.562	LNE-1500-2625-1-1

Shaft Dia.	Bore Dia.	Total In Bore Depth	Total Seal Width	ProTech Part Number
1.500	2.625	0.591	0.591	FNE-1500-2625-1-1
1.500	2.688	0.276	0.551	MLE-1500-2688-B-1
1.500	2.688	0.276	0.630	LWE-1500-2688-1-1
1.500	2.688	0.313	0.688	LSE-1500-2688-1-1
1.500	2.688	0.313	0.688	FSE-1500-2688-1-1
1.500	2.688	0.562	0.562	LNE-1500-2688-1-1
1.500	2.688	0.591	0.591	FNE-1500-2688-1-1
1.500	2.750	0.276	0.551	MLE-1500-2750-B-1
1.500	2.750	0.276	0.630	LWE-1500-2750-1-1
1.500	2.750	0.313	0.688	LSE-1500-2750-1-1
1.500	2.750	0.313	0.688	FSE-1500-2750-1-1
1.500	2.750	0.562	0.562	LNE-1500-2750-1-1
1.500	2.750	0.591	0.591	FNE-1500-2750-1-1
1.500	2.813	0.276	0.551	MLE-1500-2813-B-1
1.500	2.813	0.276	0.630	LWE-1500-2813-1-1
1.500	2.813	0.313	0.688	LSE-1500-2813-1-1
1.500	2.813	0.313	0.688	FSE-1500-2813-1-1
1.500	2.813	0.562	0.562	LNE-1500-2813-1-1
1.500	2.813	0.591	0.591	FNE-1500-2813-1-1
1.500	2.875	0.276	0.551	MLE-1500-2875-B-1
1.500	2.875	0.276	0.630	LWE-1500-2875-1-1
1.500	2.875	0.313	0.688	LSE-1500-2875-1-1
1.500	2.875	0.313	0.688	FSE-1500-2875-1-1
1.500	2.875	0.562	0.562	LNE-1500-2875-1-1
1.500	2.875	0.591	0.591	FNE-1500-2875-1-1
1.500	2.938	0.276	0.551	MLE-1500-2938-B-1
1.500	2.938	0.276	0.630	LWE-1500-2938-1-1
1.500	2.938	0.313	0.688	LSE-1500-2938-1-1
1.500	2.938	0.313	0.688	FSE-1500-2938-1-1
1.500	2.938	0.562	0.562	LNE-1500-2938-1-1
1.500	2.938	0.591	0.591	FNE-1500-2938-1-1
1.500	3.000	0.276	0.551	MLE-1500-3000-B-1
1.500	3.000	0.276	0.630	LWE-1500-3000-1-1
1.500	3.000	0.313	0.688	LSE-1500-3000-1-1
1.500	3.000	0.313	0.688	FSE-1500-3000-1-1
1.500	3.000	0.562	0.562	LNE-1500-3000-1-1
1.500	3.000	0.591	0.591	FNE-1500-3000-1-1
1.562	2.187	0.313	0.688	LSE-1562-2187-1-1
1.562	2.250	0.313	0.688	LSE-1562-2250-1-1
1.562	2.312	0.313	0.688	LSE-1562-2312-1-1
1.562	2.375	0.313	0.688	LSE-1562-2375-1-1
1.562	2.437	0.313	0.688	LSE-1562-2437-1-1
1.562	2.500	0.313	0.688	LSE-1562-2500-1-1
1.562	2.562	0.313	0.688	LSE-1562-2562-1-1
1.562	2.625	0.313	0.688	LSE-1562-2625-1-1
1.562	2.687	0.313	0.688	LSE-1562-2687-1-1
1.562	2.750	0.313	0.688	LSE-1562-2750-1-1
1.562	2.812	0.313	0.688	LSE-1562-2812-1-1
1.562	2.875	0.313	0.688	LSE-1562-2875-1-1
1.562	2.937	0.313	0.688	LSE-1562-2937-1-1
1.562	3.000	0.313	0.688	LSE-1562-3000-1-1
1.562	3.062	0.313	0.688	LSE-1562-3062-1-1
1.563	2.063	0.276	0.551	MLE-1563-2063-B-1
1.563	2.063	0.276	0.630	LWE-1563-2063-1-1
1.563	2.125	0.276	0.551	MLE-1563-2125-B-1
1.563	2.125	0.276	0.630	LWE-1563-2125-1-1
1.563	2.188	0.276	0.551	MLE-1563-2188-B-1
1.563	2.188	0.276	0.630	LWE-1563-2188-1-1
1.563	2.250	0.276	0.551	MLE-1563-2250-B-1
1.563	2.250	0.276	0.630	LWE-1563-2250-1-1
1.563	2.312	0.313	0.688	FSE-1563-2312-1-1
1.563	2.312	0.562	0.562	LNE-1563-2312-1-1
1.563	2.312	0.591	0.591	FNE-1563-2312-1-1
1.563	2.313	0.276	0.551	MLE-1563-2313-B-1
1.563	2.313	0.276	0.630	LWE-1563-2313-1-1
1.563	2.375	0.276	0.551	MLE-1563-2375-B-1



03/03/06

See **Section 4** for seal part number prefix description.



Shaft Dia.	Bore Dia.	Total In Bore Depth	Total Seal Width	ProTech Part Number
1.563	2.375	0.276	0.630	LWE-1563-2375-1-1
1.563	2.375	0.313	0.688	FSE-1563-2375-1-1
1.563	2.375	0.562	0.562	LNE-1563-2375-1-1
1.563	2.375	0.591	0.591	FNE-1563-2375-1-1
1.563	2.437	0.313	0.688	FSE-1563-2437-1-1
1.563	2.437	0.562	0.562	LNE-1563-2437-1-1
1.563	2.437	0.591	0.591	FNE-1563-2437-1-1
1.563	2.438	0.276	0.551	MLE-1563-2438-B-1
1.563	2.438	0.276	0.630	LWE-1563-2438-1-1
1.563	2.500	0.276	0.551	MLE-1563-2500-B-1
1.563	2.500	0.276	0.630	LWE-1563-2500-1-1
1.563	2.500	0.313	0.688	FSE-1563-2500-1-1
1.563	2.500	0.562	0.562	LNE-1563-2500-1-1
1.563	2.500	0.591	0.591	FNE-1563-2500-1-1
1.563	2.562	0.313	0.688	FSE-1563-2562-1-1
1.563	2.562	0.562	0.562	LNE-1563-2562-1-1
1.563	2.562	0.591	0.591	FNE-1563-2562-1-1
1.563	2.563	0.276	0.551	MLE-1563-2563-B-1
1.563	2.563	0.276	0.630	LWE-1563-2563-1-1
1.563	2.625	0.276	0.551	MLE-1563-2625-B-1
1.563	2.625	0.276	0.630	LWE-1563-2625-1-1
1.563	2.625	0.313	0.688	FSE-1563-2625-1-1
1.563	2.625	0.562	0.562	LNE-1563-2625-1-1
1.563	2.625	0.591	0.591	FNE-1563-2625-1-1
1.563	2.687	0.313	0.688	FSE-1563-2687-1-1
1.563	2.687	0.562	0.562	LNE-1563-2687-1-1
1.563	2.687	0.591	0.591	FNE-1563-2687-1-1
1.563	2.688	0.276	0.551	MLE-1563-2688-B-1
1.563	2.688	0.276	0.630	LWE-1563-2688-1-1
1.563	2.750	0.276	0.551	MLE-1563-2750-B-1
1.563	2.750	0.276	0.630	LWE-1563-2750-1-1
1.563	2.750	0.313	0.688	FSE-1563-2750-1-1
1.563	2.750	0.562	0.562	LNE-1563-2750-1-1
1.563	2.750	0.591	0.591	FNE-1563-2750-1-1
1.563	2.812	0.313	0.688	FSE-1563-2812-1-1
1.563	2.812	0.562	0.562	LNE-1563-2812-1-1
1.563	2.812	0.591	0.591	FNE-1563-2812-1-1
1.563	2.813	0.276	0.551	MLE-1563-2813-B-1
1.563	2.813	0.276	0.630	LWE-1563-2813-1-1
1.563	2.875	0.276	0.551	MLE-1563-2875-B-1
1.563	2.875	0.276	0.630	LWE-1563-2875-1-1
1.563	2.875	0.313	0.688	FSE-1563-2875-1-1
1.563	2.875	0.562	0.562	LNE-1563-2875-1-1
1.563	2.875	0.591	0.591	FNE-1563-2875-1-1
1.563	2.937	0.313	0.688	FSE-1563-2937-1-1
1.563	2.937	0.562	0.562	LNE-1563-2937-1-1
1.563	2.937	0.591	0.591	FNE-1563-2937-1-1
1.563	2.938	0.276	0.551	MLE-1563-2938-B-1
1.563	2.938	0.276	0.630	LWE-1563-2938-1-1
1.563	3.000	0.276	0.551	MLE-1563-3000-B-1
1.563	3.000	0.276	0.630	LWE-1563-3000-1-1
1.563	3.000	0.313	0.688	FSE-1563-3000-1-1
1.563	3.000	0.562	0.562	LNE-1563-3000-1-1
1.563	3.000	0.591	0.591	FNE-1563-3000-1-1
1.563	3.062	0.313	0.688	FSE-1563-3062-1-1
1.563	3.062	0.562	0.562	LNE-1563-3062-1-1
1.563	3.062	0.591	0.591	FNE-1563-3062-1-1
1.563	3.063	0.276	0.551	MLE-1563-3063-B-1
1.563	3.063	0.276	0.630	LWE-1563-3063-1-1
1.625	2.125	0.315	0.591	MLE-1625-2125-B-1
1.625	2.125	0.315	0.669	LWE-1625-2125-1-1
1.625	2.188	0.315	0.591	MLE-1625-2188-B-1
1.625	2.188	0.315	0.669	LWE-1625-2188-1-1
1.625	2.250	0.313	0.688	LSE-1625-2250-1-1
1.625	2.250	0.315	0.591	MLE-1625-2250-B-1
1.625	2.250	0.315	0.669	LWE-1625-2250-1-1

Shaft Dia.	Bore Dia.	Total In Bore Depth	Total Seal Width	ProTech Part Number
1.625	2.312	0.313	0.688	LSE-1625-2312-1-1
1.625	2.313	0.315	0.591	MLE-1625-2313-B-1
1.625	2.313	0.315	0.669	LWE-1625-2313-1-1
1.625	2.375	0.313	0.688	LSE-1625-2375-1-1
1.625	2.375	0.313	0.688	FSE-1625-2375-1-1
1.625	2.375	0.315	0.591	MLE-1625-2375-B-1
1.625	2.375	0.315	0.669	LWE-1625-2375-1-1
1.625	2.375	0.562	0.562	LNE-1625-2375-1-1
1.625	2.375	0.591	0.591	FNE-1625-2375-1-1
1.625	2.438	0.313	0.688	LSE-1625-2438-1-1
1.625	2.438	0.313	0.688	FSE-1625-2438-1-1
1.625	2.438	0.315	0.591	MLE-1625-2438-B-1
1.625	2.438	0.315	0.669	LWE-1625-2438-1-1
1.625	2.438	0.562	0.562	LNE-1625-2438-1-1
1.625	2.438	0.591	0.591	FNE-1625-2438-1-1
1.625	2.500	0.313	0.688	LSE-1625-2500-1-1
1.625	2.500	0.313	0.688	FSE-1625-2500-1-1
1.625	2.500	0.315	0.591	MLE-1625-2500-B-1
1.625	2.500	0.315	0.669	LWE-1625-2500-1-1
1.625	2.500	0.562	0.562	LNE-1625-2500-1-1
1.625	2.500	0.591	0.591	FNE-1625-2500-1-1
1.625	2.562	0.313	0.688	LSE-1625-2562-1-1
1.625	2.562	0.313	0.688	FSE-1625-2562-1-1
1.625	2.562	0.562	0.562	LNE-1625-2562-1-1
1.625	2.562	0.591	0.591	FNE-1625-2562-1-1
1.625	2.562	0.591	0.591	FNE-1625-2562-1-1
1.625	2.563	0.315	0.591	MLE-1625-2563-B-1
1.625	2.563	0.315	0.669	LWE-1625-2563-1-1
1.625	2.625	0.313	0.688	FSE-1625-2625-1-1
1.625	2.625	0.315	0.591	MLE-1625-2625-B-1
1.625	2.625	0.315	0.669	LWE-1625-2625-1-1
1.625	2.625	0.562	0.562	LNE-1625-2625-1-1
1.625	2.625	0.591	0.591	FNE-1625-2625-1-1
1.625	2.688	0.313	0.688	FSE-1625-2688-1-1
1.625	2.688	0.313	0.688	FSE-1625-2688-1-1
1.625	2.688	0.315	0.591	MLE-1625-2688-B-1
1.625	2.688	0.315	0.669	LWE-1625-2688-1-1
1.625	2.688	0.562	0.562	LNE-1625-2688-1-1
1.625	2.688	0.591	0.591	FNE-1625-2688-1-1
1.625	2.750	0.313	0.688	LSE-1625-2750-1-1
1.625	2.750	0.313	0.688	FSE-1625-2750-1-1
1.625	2.750	0.315	0.591	MLE-1625-2750-B-1
1.625	2.750	0.315	0.669	LWE-1625-2750-1-1
1.625	2.750	0.562	0.562	LNE-1625-2750-1-1
1.625	2.750	0.591	0.591	FNE-1625-2750-1-1
1.625	2.813	0.313	0.688	LSE-1625-2813-1-1
1.625	2.813	0.313	0.688	FSE-1625-2813-1-1
1.625	2.813	0.315	0.591	MLE-1625-2813-B-1
1.625	2.813	0.315	0.669	LWE-1625-2813-1-1
1.625	2.813	0.562	0.562	LNE-1625-2813-1-1
1.625	2.813	0.591	0.591	FNE-1625-2813-1-1
1.625	2.875	0.313	0.688	LSE-1625-2875-1-1
1.625	2.875	0.313	0.688	FSE-1625-2875-1-1
1.625	2.875	0.315	0.591	MLE-1625-2875-B-1
1.625	2.875	0.315	0.669	LWE-1625-2875-1-1
1.625	2.875	0.562	0.562	LNE-1625-2875-1-1
1.625	2.875	0.591	0.591	FNE-1625-2875-1-1
1.625	2.938	0.313	0.688	LSE-1625-2938-1-1
1.625	2.938	0.313	0.688	FSE-1625-2938-1-1
1.625	2.938	0.315	0.591	MLE-1625-2938-B-1
1.625	2.938	0.315	0.669	LWE-1625-2938-1-1
1.625	2.938	0.562	0.562	LNE-1625-2938-1-1
1.625	2.938	0.591	0.591	FNE-1625-2938-1-1
1.625	3.000	0.313	0.688	LSE-1625-3000-1-1
1.625	3.000	0.313	0.688	FSE-1625-3000-1-1
1.625	3.000	0.315	0.591	MLE-1625-3000-B-1
1.625	3.000	0.315	0.669	LWE-1625-3000-1-1

See Section 4 for seal part number prefix description.

03/03/06



1.625 to 1.750

Shaft Dia.	Bore Dia.	Total In Bore Depth	Total Seal Width	ProTech Part Number
1.625	3.000	0.315	0.669	LWE-1625-3000-1-1
1.625	3.000	0.562	0.562	LNE-1625-3000-1-1
1.625	3.000	0.591	0.591	FNE-1625-3000-1-1
1.625	3.062	0.313	0.688	LSE-1625-3062-1-1
1.625	3.062	0.313	0.688	FSE-1625-3062-1-1
1.625	3.062	0.562	0.562	LNE-1625-3062-1-1
1.625	3.062	0.591	0.591	FNE-1625-3062-1-1
1.625	3.063	0.315	0.591	MLE-1625-3063-B-1
1.625	3.063	0.315	0.669	LWE-1625-3063-1-1
1.625	3.125	0.313	0.688	LSE-1625-3125-1-1
1.625	3.125	0.313	0.688	FSE-1625-3125-1-1
1.625	3.125	0.315	0.591	MLE-1625-3125-B-1
1.625	3.125	0.315	0.669	LWE-1625-3125-1-1
1.625	3.125	0.562	0.562	LNE-1625-3125-1-1
1.625	3.125	0.591	0.591	FNE-1625-3125-1-1
1.688	2.188	0.315	0.591	MLE-1688-2188-B-1
1.688	2.188	0.315	0.669	LWE-1688-2188-1-1
1.688	2.250	0.315	0.591	MLE-1688-2250-B-1
1.688	2.250	0.315	0.669	LWE-1688-2250-1-1
1.688	2.313	0.313	0.688	LSE-1688-2313-1-1
1.688	2.313	0.315	0.591	MLE-1688-2313-B-1
1.688	2.313	0.315	0.669	LWE-1688-2313-1-1
1.688	2.375	0.313	0.688	LSE-1688-2375-1-1
1.688	2.375	0.315	0.591	MLE-1688-2375-B-1
1.688	2.375	0.315	0.669	LWE-1688-2375-1-1
1.688	2.438	0.313	0.688	LSE-1688-2438-1-1
1.688	2.438	0.313	0.688	FSE-1688-2438-1-1
1.688	2.438	0.315	0.591	MLE-1688-2438-B-1
1.688	2.438	0.315	0.669	LWE-1688-2438-1-1
1.688	2.438	0.562	0.562	LNE-1688-2438-1-1
1.688	2.438	0.591	0.591	FNE-1688-2438-1-1
1.688	2.500	0.313	0.688	LSE-1688-2500-1-1
1.688	2.500	0.313	0.688	FSE-1688-2500-1-1
1.688	2.500	0.315	0.591	MLE-1688-2500-B-1
1.688	2.500	0.315	0.669	LWE-1688-2500-1-1
1.688	2.500	0.562	0.562	LNE-1688-2500-1-1
1.688	2.500	0.591	0.591	FNE-1688-2500-1-1
1.688	2.563	0.313	0.688	LSE-1688-2563-1-1
1.688	2.563	0.313	0.688	FSE-1688-2563-1-1
1.688	2.563	0.315	0.591	MLE-1688-2563-B-1
1.688	2.563	0.315	0.669	LWE-1688-2563-1-1
1.688	2.563	0.562	0.562	LNE-1688-2563-1-1
1.688	2.563	0.591	0.591	FNE-1688-2563-1-1
1.688	2.625	0.313	0.688	LSE-1688-2625-1-1
1.688	2.625	0.313	0.688	FSE-1688-2625-1-1
1.688	2.625	0.315	0.591	MLE-1688-2625-B-1
1.688	2.625	0.315	0.669	LWE-1688-2625-1-1
1.688	2.625	0.562	0.562	LNE-1688-2625-1-1
1.688	2.625	0.591	0.591	FNE-1688-2625-1-1
1.688	2.688	0.313	0.688	LSE-1688-2688-1-1
1.688	2.688	0.313	0.688	FSE-1688-2688-1-1
1.688	2.688	0.315	0.591	MLE-1688-2688-B-1
1.688	2.688	0.315	0.669	LWE-1688-2688-1-1
1.688	2.688	0.562	0.562	LNE-1688-2688-1-1
1.688	2.688	0.591	0.591	FNE-1688-2688-1-1
1.688	2.750	0.313	0.688	LSE-1688-2750-1-1
1.688	2.750	0.313	0.688	FSE-1688-2750-1-1
1.688	2.750	0.315	0.591	MLE-1688-2750-B-1
1.688	2.750	0.315	0.669	LWE-1688-2750-1-1
1.688	2.750	0.562	0.562	LNE-1688-2750-1-1
1.688	2.750	0.591	0.591	FNE-1688-2750-1-1
1.688	2.813	0.313	0.688	LSE-1688-2813-1-1
1.688	2.813	0.313	0.688	FSE-1688-2813-1-1
1.688	2.813	0.315	0.591	MLE-1688-2813-B-1
1.688	2.813	0.315	0.669	LWE-1688-2813-1-1
1.688	2.813	0.562	0.562	LNE-1688-2813-1-1

Shaft Dia.	Bore Dia.	Total In Bore Depth	Total Seal Width	ProTech Part Number
1.688	2.813	0.591	0.591	FNE-1688-2813-1-1
1.688	2.875	0.313	0.688	LSE-1688-2875-1-1
1.688	2.875	0.313	0.688	FSE-1688-2875-1-1
1.688	2.875	0.315	0.591	MLE-1688-2875-B-1
1.688	2.875	0.315	0.669	LWE-1688-2875-1-1
1.688	2.875	0.562	0.562	LNE-1688-2875-1-1
1.688	2.875	0.591	0.591	FNE-1688-2875-1-1
1.688	2.938	0.313	0.688	LSE-1688-2938-1-1
1.688	2.938	0.313	0.688	FSE-1688-2938-1-1
1.688	2.938	0.315	0.591	MLE-1688-2938-B-1
1.688	2.938	0.315	0.669	LWE-1688-2938-1-1
1.688	2.938	0.562	0.562	LNE-1688-2938-1-1
1.688	2.938	0.591	0.591	FNE-1688-2938-1-1
1.688	2.938	0.313	0.688	LSE-1688-2938-1-1
1.688	2.938	0.313	0.688	FSE-1688-2938-1-1
1.688	2.938	0.315	0.591	MLE-1688-2938-B-1
1.688	2.938	0.315	0.669	LWE-1688-2938-1-1
1.688	2.938	0.562	0.562	LNE-1688-2938-1-1
1.688	2.938	0.591	0.591	FNE-1688-2938-1-1
1.688	3.000	0.313	0.688	LSE-1688-3000-1-1
1.688	3.000	0.313	0.688	FSE-1688-3000-1-1
1.688	3.000	0.315	0.591	MLE-1688-3000-B-1
1.688	3.000	0.315	0.669	LWE-1688-3000-1-1
1.688	3.000	0.562	0.562	LNE-1688-3000-1-1
1.688	3.000	0.591	0.591	FNE-1688-3000-1-1
1.688	3.063	0.313	0.688	LSE-1688-3063-1-1
1.688	3.063	0.313	0.688	FSE-1688-3063-1-1
1.688	3.063	0.315	0.591	MLE-1688-3063-B-1
1.688	3.063	0.315	0.669	LWE-1688-3063-1-1
1.688	3.063	0.562	0.562	LNE-1688-3063-1-1
1.688	3.063	0.591	0.591	FNE-1688-3063-1-1
1.688	3.125	0.313	0.688	LSE-1688-3125-1-1
1.688	3.125	0.315	0.591	MLE-1688-3125-B-1
1.688	3.125	0.315	0.669	LWE-1688-3125-1-1
1.688	3.125	0.562	0.562	LNE-1688-3125-1-1
1.688	3.125	0.591	0.591	FNE-1688-3125-1-1
1.688	3.188	0.313	0.688	LSE-1688-3188-1-1
1.688	3.188	0.313	0.688	FSE-1688-3188-1-1
1.688	3.188	0.315	0.591	MLE-1688-3188-B-1
1.688	3.188	0.315	0.669	LWE-1688-3188-1-1
1.688	3.188	0.562	0.562	LNE-1688-3188-1-1
1.688	3.188	0.591	0.591	FNE-1688-3188-1-1
1.688	3.188	0.591	0.591	FNE-1688-3188-1-1
1.750	2.250	0.315	0.591	MLE-1750-2250-B-1
1.750	2.250	0.315	0.669	LWE-1750-2250-1-1
1.750	2.313	0.315	0.591	MLE-1750-2313-B-1
1.750	2.313	0.315	0.669	LWE-1750-2313-1-1
1.750	2.375	0.313	0.688	LSE-1750-2375-1-1
1.750	2.375	0.315	0.591	MLE-1750-2375-B-1
1.750	2.375	0.315	0.669	LWE-1750-2375-1-1
1.750	2.438	0.313	0.688	LSE-1750-2438-1-1
1.750	2.438	0.315	0.591	MLE-1750-2438-B-1
1.750	2.438	0.315	0.669	LWE-1750-2438-1-1
1.750	2.500	0.313	0.688	LSE-1750-2500-1-1
1.750	2.500	0.313	0.688	FSE-1750-2500-1-1
1.750	2.500	0.315	0.591	MLE-1750-2500-B-1
1.750	2.500	0.315	0.669	LWE-1750-2500-1-1
1.750	2.500	0.562	0.562	LNE-1750-2500-1-1
1.750	2.500	0.591	0.591	FNE-1750-2500-1-1
1.750	2.562	0.313	0.688	LSE-1750-2562-1-1
1.750	2.562	0.313	0.688	FSE-1750-2562-1-1
1.750	2.562	0.562	0.562	LNE-1750-2562-1-1
1.750	2.562	0.591	0.591	FNE-1750-2562-1-1
1.750	2.563	0.315	0.591	MLE-1750-2563-B-1
1.750	2.563	0.315	0.669	LWE-1750-2563-1-1
1.750	2.625	0.313	0.688	LSE-1750-2625-1-1
1.750	2.625	0.313	0.688	FSE-1750-2625-1-1
1.750	2.625	0.315	0.591	MLE-1750-2625-B-1
1.750	2.625	0.315	0.669	LWE-1750-2625-1-1
1.750	2.625	0.562	0.562	LNE-1750-2625-1-1
1.750	2.625	0.591	0.591	FNE-1750-2625-1-1
1.750	2.688	0.313	0.688	LSE-1750-2688-1-1



03/03/06

See **Section 4** for seal part number prefix description.



Shaft Dia.	Bore Dia.	Total In Bore Depth	Total Seal Width	ProTech Part Number
1.750	2.688	0.313	0.688	FSE-1750-2688-1-1
1.750	2.688	0.315	0.591	MLE-1750-2688-B-1
1.750	2.688	0.315	0.669	LWE-1750-2688-1-1
1.750	2.688	0.562	0.562	LNE-1750-2688-1-1
1.750	2.688	0.591	0.591	FNE-1750-2688-1-1
1.750	2.750	0.313	0.688	LSE-1750-2750-1-1
1.750	2.750	0.313	0.688	FSE-1750-2750-1-1
1.750	2.750	0.315	0.591	MLE-1750-2750-B-1
1.750	2.750	0.315	0.669	LWE-1750-2750-1-1
1.750	2.750	0.562	0.562	LNE-1750-2750-1-1
1.750	2.750	0.591	0.591	FNE-1750-2750-1-1
1.750	2.812	0.313	0.688	LSE-1750-2812-1-1
1.750	2.812	0.313	0.688	FSE-1750-2812-1-1
1.750	2.812	0.562	0.562	LNE-1750-2812-1-1
1.750	2.812	0.591	0.591	FNE-1750-2812-1-1
1.750	2.813	0.315	0.591	MLE-1750-2813-B-1
1.750	2.813	0.315	0.669	LWE-1750-2813-1-1
1.750	2.875	0.313	0.688	LSE-1750-2875-1-1
1.750	2.875	0.313	0.688	FSE-1750-2875-1-1
1.750	2.875	0.315	0.591	MLE-1750-2875-B-1
1.750	2.875	0.315	0.669	LWE-1750-2875-1-1
1.750	2.875	0.562	0.562	LNE-1750-2875-1-1
1.750	2.875	0.591	0.591	FNE-1750-2875-1-1
1.750	2.938	0.313	0.688	LSE-1750-2938-1-1
1.750	2.938	0.313	0.688	FSE-1750-2938-1-1
1.750	2.938	0.315	0.591	MLE-1750-2938-B-1
1.750	2.938	0.315	0.669	LWE-1750-2938-1-1
1.750	2.938	0.562	0.562	LNE-1750-2938-1-1
1.750	2.938	0.591	0.591	FNE-1750-2938-1-1
1.750	3.000	0.313	0.688	LSE-1750-3000-1-1
1.750	3.000	0.313	0.688	FSE-1750-3000-1-1
1.750	3.000	0.315	0.591	MLE-1750-3000-B-1
1.750	3.000	0.315	0.669	LWE-1750-3000-1-1
1.750	3.000	0.562	0.562	LNE-1750-3000-1-1
1.750	3.000	0.591	0.591	FNE-1750-3000-1-1
1.750	3.062	0.313	0.688	LSE-1750-3062-1-1
1.750	3.062	0.313	0.688	FSE-1750-3062-1-1
1.750	3.062	0.562	0.562	LNE-1750-3062-1-1
1.750	3.062	0.591	0.591	FNE-1750-3062-1-1
1.750	3.063	0.315	0.591	MLE-1750-3063-B-1
1.750	3.063	0.315	0.669	LWE-1750-3063-1-1
1.750	3.125	0.313	0.688	LSE-1750-3125-1-1
1.750	3.125	0.313	0.688	FSE-1750-3125-1-1
1.750	3.125	0.315	0.591	MLE-1750-3125-B-1
1.750	3.125	0.315	0.669	LWE-1750-3125-1-1
1.750	3.125	0.562	0.562	LNE-1750-3125-1-1
1.750	3.125	0.591	0.591	FNE-1750-3125-1-1
1.750	3.188	0.313	0.688	LSE-1750-3188-1-1
1.750	3.188	0.313	0.688	FSE-1750-3188-1-1
1.750	3.188	0.315	0.591	MLE-1750-3188-B-1
1.750	3.188	0.315	0.669	LWE-1750-3188-1-1
1.750	3.188	0.562	0.562	LNE-1750-3188-1-1
1.750	3.188	0.591	0.591	FNE-1750-3188-1-1
1.750	3.250	0.313	0.688	LSE-1750-3250-1-1
1.750	3.250	0.313	0.688	FSE-1750-3250-1-1
1.750	3.250	0.315	0.591	MLE-1750-3250-B-1
1.750	3.250	0.315	0.669	LWE-1750-3250-1-1
1.750	3.250	0.562	0.562	LNE-1750-3250-1-1
1.750	3.250	0.591	0.591	FNE-1750-3250-1-1
1.812	2.437	0.313	0.688	LSE-1812-2437-1-1
1.812	2.500	0.313	0.688	LSE-1812-2500-1-1
1.812	2.562	0.313	0.688	LSE-1812-2562-1-1
1.812	2.625	0.313	0.688	LSE-1812-2625-1-1
1.812	2.687	0.313	0.688	LSE-1812-2687-1-1
1.812	2.750	0.313	0.688	LSE-1812-2750-1-1
1.812	2.812	0.313	0.688	LSE-1812-2812-1-1

Shaft Dia.	Bore Dia.	Total In Bore Depth	Total Seal Width	ProTech Part Number
1.812	2.875	0.313	0.688	LSE-1812-2875-1-1
1.812	2.937	0.313	0.688	LSE-1812-2937-1-1
1.812	3.000	0.313	0.688	LSE-1812-3000-1-1
1.812	3.062	0.313	0.688	LSE-1812-3062-1-1
1.812	3.125	0.313	0.688	LSE-1812-3125-1-1
1.812	3.187	0.313	0.688	LSE-1812-3187-1-1
1.812	3.250	0.313	0.688	LSE-1812-3250-1-1
1.812	3.312	0.313	0.688	LSE-1812-3312-1-1
1.813	2.313	0.315	0.591	MLE-1813-2313-B-1
1.813	2.313	0.315	0.669	LWE-1813-2313-1-1
1.813	2.375	0.315	0.591	MLE-1813-2375-B-1
1.813	2.375	0.315	0.669	LWE-1813-2375-1-1
1.813	2.438	0.315	0.591	MLE-1813-2438-B-1
1.813	2.438	0.315	0.669	LWE-1813-2438-1-1
1.813	2.500	0.315	0.591	MLE-1813-2500-B-1
1.813	2.500	0.315	0.669	LWE-1813-2500-1-1
1.813	2.562	0.313	0.688	FSE-1813-2562-1-1
1.813	2.562	0.562	0.562	LNE-1813-2562-1-1
1.813	2.562	0.591	0.591	FNE-1813-2562-1-1
1.813	2.563	0.315	0.591	MLE-1813-2563-B-1
1.813	2.563	0.315	0.669	LWE-1813-2563-1-1
1.813	2.625	0.313	0.688	FSE-1813-2625-1-1
1.813	2.625	0.315	0.591	MLE-1813-2625-B-1
1.813	2.625	0.315	0.669	LWE-1813-2625-1-1
1.813	2.625	0.562	0.562	LNE-1813-2625-1-1
1.813	2.625	0.591	0.591	FNE-1813-2625-1-1
1.813	2.687	0.313	0.688	FSE-1813-2687-1-1
1.813	2.687	0.562	0.562	LNE-1813-2687-1-1
1.813	2.687	0.591	0.591	FNE-1813-2687-1-1
1.813	2.688	0.315	0.591	MLE-1813-2688-B-1
1.813	2.688	0.315	0.669	LWE-1813-2688-1-1
1.813	2.750	0.313	0.688	FSE-1813-2750-1-1
1.813	2.750	0.315	0.591	MLE-1813-2750-B-1
1.813	2.750	0.315	0.669	LWE-1813-2750-1-1
1.813	2.750	0.562	0.562	LNE-1813-2750-1-1
1.813	2.750	0.591	0.591	FNE-1813-2750-1-1
1.813	2.812	0.313	0.688	FSE-1813-2812-1-1
1.813	2.812	0.562	0.562	LNE-1813-2812-1-1
1.813	2.812	0.591	0.591	FNE-1813-2812-1-1
1.813	2.813	0.315	0.591	MLE-1813-2813-B-1
1.813	2.813	0.315	0.669	LWE-1813-2813-1-1
1.813	2.875	0.313	0.688	FSE-1813-2875-1-1
1.813	2.875	0.315	0.591	MLE-1813-2875-B-1
1.813	2.875	0.315	0.669	LWE-1813-2875-1-1
1.813	2.875	0.562	0.562	LNE-1813-2875-1-1
1.813	2.875	0.591	0.591	FNE-1813-2875-1-1
1.813	2.937	0.313	0.688	FSE-1813-2937-1-1
1.813	2.937	0.562	0.562	LNE-1813-2937-1-1
1.813	2.937	0.591	0.591	FNE-1813-2937-1-1
1.813	2.938	0.315	0.591	MLE-1813-2938-B-1
1.813	2.938	0.315	0.669	LWE-1813-2938-1-1
1.813	3.000	0.313	0.688	FSE-1813-3000-1-1
1.813	3.000	0.315	0.591	MLE-1813-3000-B-1
1.813	3.000	0.315	0.669	LWE-1813-3000-1-1
1.813	3.000	0.562	0.562	LNE-1813-3000-1-1
1.813	3.000	0.591	0.591	FNE-1813-3000-1-1
1.813	3.062	0.313	0.688	FSE-1813-3062-1-1
1.813	3.062	0.562	0.562	LNE-1813-3062-1-1
1.813	3.062	0.591	0.591	FNE-1813-3062-1-1
1.813	3.063	0.315	0.591	MLE-1813-3063-B-1
1.813	3.063	0.315	0.669	LWE-1813-3063-1-1
1.813	3.125	0.313	0.688	FSE-1813-3125-1-1
1.813	3.125	0.315	0.591	MLE-1813-3125-B-1
1.813	3.125	0.315	0.669	LWE-1813-3125-1-1
1.813	3.125	0.562	0.562	LNE-1813-3125-1-1
1.813	3.125	0.591	0.591	FNE-1813-3125-1-1

F

03/03/06

See Section 4 for seal part number prefix description.



1.813 to 1.938

Shaft Dia.	Bore Dia.	Total In Bore Depth	Total Seal Width	ProTech Part Number
1.813	3.187	0.313	0.688	FSE-1813-3187-1-1
1.813	3.187	0.562	0.562	LNE-1813-3187-1-1
1.813	3.187	0.591	0.591	FNE-1813-3187-1-1
1.813	3.188	0.315	0.591	MLE-1813-3188-B-1
1.813	3.188	0.315	0.669	LWE-1813-3188-1-1
1.813	3.250	0.313	0.688	FSE-1813-3250-1-1
1.813	3.250	0.315	0.591	MLE-1813-3250-B-1
1.813	3.250	0.315	0.669	LWE-1813-3250-1-1
1.813	3.250	0.562	0.562	LNE-1813-3250-1-1
1.813	3.250	0.591	0.591	FNE-1813-3250-1-1
1.813	3.312	0.313	0.688	FSE-1813-3312-1-1
1.813	3.312	0.562	0.562	LNE-1813-3312-1-1
1.813	3.312	0.591	0.591	FNE-1813-3312-1-1
1.813	3.313	0.315	0.591	MLE-1813-3313-B-1
1.813	3.313	0.315	0.669	LWE-1813-3313-1-1
1.875	2.375	0.315	0.591	MLE-1875-2375-B-1
1.875	2.375	0.315	0.669	LWE-1875-2375-1-1
1.875	2.438	0.315	0.591	MLE-1875-2438-B-1
1.875	2.438	0.315	0.669	LWE-1875-2438-1-1
1.875	2.500	0.313	0.688	LSE-1875-2500-1-1
1.875	2.500	0.315	0.591	MLE-1875-2500-B-1
1.875	2.500	0.315	0.669	LWE-1875-2500-1-1
1.875	2.562	0.313	0.688	LSE-1875-2562-1-1
1.875	2.563	0.315	0.591	MLE-1875-2563-B-1
1.875	2.563	0.315	0.669	LWE-1875-2563-1-1
1.875	2.625	0.313	0.688	LSE-1875-2625-1-1
1.875	2.625	0.313	0.688	FSE-1875-2625-1-1
1.875	2.625	0.315	0.591	MLE-1875-2625-B-1
1.875	2.625	0.315	0.669	LWE-1875-2625-1-1
1.875	2.625	0.562	0.562	LNE-1875-2625-1-1
1.875	2.625	0.591	0.591	FNE-1875-2625-1-1
1.875	2.688	0.313	0.688	LSE-1875-2688-1-1
1.875	2.688	0.313	0.688	FSE-1875-2688-1-1
1.875	2.688	0.315	0.591	MLE-1875-2688-B-1
1.875	2.688	0.315	0.669	LWE-1875-2688-1-1
1.875	2.688	0.562	0.562	LNE-1875-2688-1-1
1.875	2.688	0.591	0.591	FNE-1875-2688-1-1
1.875	2.750	0.313	0.688	LSE-1875-2750-1-1
1.875	2.750	0.313	0.688	FSE-1875-2750-1-1
1.875	2.750	0.315	0.591	MLE-1875-2750-B-1
1.875	2.750	0.315	0.669	LWE-1875-2750-1-1
1.875	2.750	0.562	0.562	LNE-1875-2750-1-1
1.875	2.750	0.591	0.591	FNE-1875-2750-1-1
1.875	2.813	0.313	0.688	LSE-1875-2813-1-1
1.875	2.813	0.313	0.688	FSE-1875-2813-1-1
1.875	2.813	0.315	0.591	MLE-1875-2813-B-1
1.875	2.813	0.315	0.669	LWE-1875-2813-1-1
1.875	2.813	0.562	0.562	LNE-1875-2813-1-1
1.875	2.813	0.591	0.591	FNE-1875-2813-1-1
1.875	2.875	0.313	0.688	LSE-1875-2875-1-1
1.875	2.875	0.313	0.688	FSE-1875-2875-1-1
1.875	2.875	0.315	0.591	MLE-1875-2875-B-1
1.875	2.875	0.315	0.669	LWE-1875-2875-1-1
1.875	2.875	0.562	0.562	LNE-1875-2875-1-1
1.875	2.875	0.591	0.591	FNE-1875-2875-1-1
1.875	2.938	0.313	0.688	LSE-1875-2938-1-1
1.875	2.938	0.313	0.688	FSE-1875-2938-1-1
1.875	2.938	0.315	0.591	MLE-1875-2938-B-1
1.875	2.938	0.315	0.669	LWE-1875-2938-1-1
1.875	2.938	0.562	0.562	LNE-1875-2938-1-1
1.875	2.938	0.591	0.591	FNE-1875-2938-1-1
1.875	3.000	0.313	0.688	LSE-1875-3000-1-1
1.875	3.000	0.313	0.688	FSE-1875-3000-1-1
1.875	3.000	0.315	0.591	MLE-1875-3000-B-1
1.875	3.000	0.315	0.669	LWE-1875-3000-1-1
1.875	3.000	0.562	0.562	LNE-1875-3000-1-1

Shaft Dia.	Bore Dia.	Total In Bore Depth	Total Seal Width	ProTech Part Number
1.875	3.000	0.591	0.591	FNE-1875-3000-1-1
1.875	3.062	0.313	0.688	LSE-1875-3062-1-1
1.875	3.062	0.313	0.688	FSE-1875-3062-1-1
1.875	3.062	0.562	0.562	LNE-1875-3062-1-1
1.875	3.062	0.591	0.591	FNE-1875-3062-1-1
1.875	3.063	0.315	0.591	MLE-1875-3063-B-1
1.875	3.063	0.315	0.669	LWE-1875-3063-1-1
1.875	3.125	0.313	0.688	LSE-1875-3125-1-1
1.875	3.125	0.313	0.688	FSE-1875-3125-1-1
1.875	3.125	0.315	0.591	MLE-1875-3125-B-1
1.875	3.125	0.315	0.669	LWE-1875-3125-1-1
1.875	3.125	0.562	0.562	LNE-1875-3125-1-1
1.875	3.125	0.591	0.591	FNE-1875-3125-1-1
1.875	3.188	0.313	0.688	LSE-1875-3188-1-1
1.875	3.188	0.313	0.688	FSE-1875-3188-1-1
1.875	3.188	0.315	0.591	MLE-1875-3188-B-1
1.875	3.188	0.315	0.669	LWE-1875-3188-1-1
1.875	3.188	0.562	0.562	LNE-1875-3188-1-1
1.875	3.188	0.591	0.591	FNE-1875-3188-1-1
1.875	3.250	0.313	0.688	LSE-1875-3250-1-1
1.875	3.250	0.313	0.688	FSE-1875-3250-1-1
1.875	3.250	0.315	0.591	MLE-1875-3250-B-1
1.875	3.250	0.315	0.669	LWE-1875-3250-1-1
1.875	3.250	0.562	0.562	LNE-1875-3250-1-1
1.875	3.250	0.591	0.591	FNE-1875-3250-1-1
1.875	3.312	0.313	0.688	LSE-1875-3312-1-1
1.875	3.312	0.313	0.688	FSE-1875-3312-1-1
1.875	3.312	0.562	0.562	LNE-1875-3312-1-1
1.875	3.312	0.591	0.591	FNE-1875-3312-1-1
1.875	3.313	0.315	0.591	MLE-1875-3313-B-1
1.875	3.313	0.315	0.669	LWE-1875-3313-1-1
1.875	3.375	0.313	0.688	LSE-1875-3375-1-1
1.875	3.375	0.313	0.688	FSE-1875-3375-1-1
1.875	3.375	0.315	0.591	MLE-1875-3375-B-1
1.875	3.375	0.315	0.669	LWE-1875-3375-1-1
1.875	3.375	0.562	0.562	LNE-1875-3375-1-1
1.875	3.375	0.591	0.591	FNE-1875-3375-1-1
1.938	2.438	0.315	0.591	MLE-1938-2438-B-1
1.938	2.438	0.315	0.669	LWE-1938-2438-1-1
1.938	2.500	0.315	0.591	MLE-1938-2500-B-1
1.938	2.500	0.315	0.669	LWE-1938-2500-1-1
1.938	2.563	0.313	0.688	LSE-1938-2563-1-1
1.938	2.563	0.315	0.591	MLE-1938-2563-B-1
1.938	2.563	0.315	0.669	LWE-1938-2563-1-1
1.938	2.625	0.313	0.688	LSE-1938-2625-1-1
1.938	2.625	0.315	0.591	MLE-1938-2625-B-1
1.938	2.625	0.315	0.669	LWE-1938-2625-1-1
1.938	2.688	0.313	0.688	LSE-1938-2688-1-1
1.938	2.688	0.313	0.688	FSE-1938-2688-1-1
1.938	2.688	0.315	0.591	MLE-1938-2688-B-1
1.938	2.688	0.315	0.669	LWE-1938-2688-1-1
1.938	2.688	0.562	0.562	LNE-1938-2688-1-1
1.938	2.688	0.591	0.591	FNE-1938-2688-1-1
1.938	2.750	0.313	0.688	LSE-1938-2750-1-1
1.938	2.750	0.313	0.688	FSE-1938-2750-1-1
1.938	2.750	0.315	0.591	MLE-1938-2750-B-1
1.938	2.750	0.315	0.669	LWE-1938-2750-1-1
1.938	2.750	0.562	0.562	LNE-1938-2750-1-1
1.938	2.750	0.591	0.591	FNE-1938-2750-1-1
1.938	2.813	0.313	0.688	LSE-1938-2813-1-1
1.938	2.813	0.313	0.688	FSE-1938-2813-1-1
1.938	2.813	0.315	0.591	MLE-1938-2813-B-1
1.938	2.813	0.315	0.669	LWE-1938-2813-1-1
1.938	2.813	0.562	0.562	LNE-1938-2813-1-1
1.938	2.813	0.591	0.591	FNE-1938-2813-1-1
1.938	2.875	0.313	0.688	LSE-1938-2875-1-1



See **Section 4** for seal part number prefix description.

03/03/06



Shaft Dia.	Bore Dia.	Total In Bore Depth	Total Seal Width	ProTech Part Number
1.938	2.875	0.313	0.688	FSE-1938-2875-1-1
1.938	2.875	0.315	0.591	MLE-1938-2875-B-1
1.938	2.875	0.315	0.669	LWE-1938-2875-1-1
1.938	2.875	0.562	0.562	LNE-1938-2875-1-1
1.938	2.875	0.591	0.591	FNE-1938-2875-1-1
1.938	2.938	0.313	0.688	LSE-1938-2938-1-1
1.938	2.938	0.313	0.688	FSE-1938-2938-1-1
1.938	2.938	0.315	0.591	MLE-1938-2938-B-1
1.938	2.938	0.315	0.669	LWE-1938-2938-1-1
1.938	2.938	0.562	0.562	LNE-1938-2938-1-1
1.938	2.938	0.591	0.591	FNE-1938-2938-1-1
1.938	3.000	0.313	0.688	LSE-1938-3000-1-1
1.938	3.000	0.313	0.688	FSE-1938-3000-1-1
1.938	3.000	0.315	0.591	MLE-1938-3000-B-1
1.938	3.000	0.315	0.669	LWE-1938-3000-1-1
1.938	3.000	0.562	0.562	LNE-1938-3000-1-1
1.938	3.000	0.591	0.591	FNE-1938-3000-1-1
1.938	3.063	0.313	0.688	LSE-1938-3063-1-1
1.938	3.063	0.313	0.688	FSE-1938-3063-1-1
1.938	3.063	0.315	0.591	MLE-1938-3063-B-1
1.938	3.063	0.315	0.669	LWE-1938-3063-1-1
1.938	3.063	0.562	0.562	LNE-1938-3063-1-1
1.938	3.063	0.591	0.591	FNE-1938-3063-1-1
1.938	3.125	0.313	0.688	LSE-1938-3125-1-1
1.938	3.125	0.313	0.688	FSE-1938-3125-1-1
1.938	3.125	0.315	0.591	MLE-1938-3125-B-1
1.938	3.125	0.315	0.669	LWE-1938-3125-1-1
1.938	3.125	0.562	0.562	LNE-1938-3125-1-1
1.938	3.125	0.591	0.591	FNE-1938-3125-1-1
1.938	3.188	0.313	0.688	LSE-1938-3188-1-1
1.938	3.188	0.313	0.688	FSE-1938-3188-1-1
1.938	3.188	0.315	0.591	MLE-1938-3188-B-1
1.938	3.188	0.315	0.669	LWE-1938-3188-1-1
1.938	3.188	0.562	0.562	LNE-1938-3188-1-1
1.938	3.188	0.591	0.591	FNE-1938-3188-1-1
1.938	3.250	0.313	0.688	LSE-1938-3250-1-1
1.938	3.250	0.313	0.688	FSE-1938-3250-1-1
1.938	3.250	0.315	0.591	MLE-1938-3250-B-1
1.938	3.250	0.315	0.669	LWE-1938-3250-1-1
1.938	3.250	0.562	0.562	LNE-1938-3250-1-1
1.938	3.250	0.591	0.591	FNE-1938-3250-1-1
1.938	3.313	0.313	0.688	LSE-1938-3313-1-1
1.938	3.313	0.313	0.688	FSE-1938-3313-1-1
1.938	3.313	0.315	0.591	MLE-1938-3313-B-1
1.938	3.313	0.315	0.669	LWE-1938-3313-1-1
1.938	3.313	0.562	0.562	LNE-1938-3313-1-1
1.938	3.313	0.591	0.591	FNE-1938-3313-1-1
1.938	3.375	0.313	0.688	LSE-1938-3375-1-1
1.938	3.375	0.313	0.688	FSE-1938-3375-1-1
1.938	3.375	0.315	0.591	MLE-1938-3375-B-1
1.938	3.375	0.315	0.669	LWE-1938-3375-1-1
1.938	3.375	0.562	0.562	LNE-1938-3375-1-1
1.938	3.375	0.591	0.591	FNE-1938-3375-1-1
1.938	3.438	0.313	0.688	LSE-1938-3438-1-1
1.938	3.438	0.313	0.688	FSE-1938-3438-1-1
1.938	3.438	0.315	0.591	MLE-1938-3438-B-1
1.938	3.438	0.315	0.669	LWE-1938-3438-1-1
1.938	3.438	0.562	0.562	LNE-1938-3438-1-1
1.938	3.438	0.591	0.591	FNE-1938-3438-1-1
2.000	2.500	0.315	0.591	MLE-2000-2500-B-1
2.000	2.500	0.315	0.669	LWE-2000-2500-1-1
2.000	2.563	0.315	0.591	MLE-2000-2563-B-1
2.000	2.563	0.315	0.669	LWE-2000-2563-1-1
2.000	2.625	0.313	0.688	LSE-2000-2625-1-1
2.000	2.625	0.315	0.591	MLE-2000-2625-B-1
2.000	2.625	0.315	0.669	LWE-2000-2625-1-1

Shaft Dia.	Bore Dia.	Total In Bore Depth	Total Seal Width	ProTech Part Number
2.000	2.688	0.313	0.688	LSE-2000-2688-1-1
2.000	2.688	0.315	0.591	MLE-2000-2688-B-1
2.000	2.688	0.315	0.669	LWE-2000-2688-1-1
2.000	2.750	0.313	0.688	LSE-2000-2750-1-1
2.000	2.750	0.313	0.688	FSE-2000-2750-1-1
2.000	2.750	0.315	0.591	MLE-2000-2750-B-1
2.000	2.750	0.315	0.669	LWE-2000-2750-1-1
2.000	2.750	0.562	0.562	LNE-2000-2750-1-1
2.000	2.750	0.591	0.591	FNE-2000-2750-1-1
2.000	2.813	0.313	0.688	LSE-2000-2813-1-1
2.000	2.813	0.315	0.591	MLE-2000-2813-B-1
2.000	2.813	0.315	0.669	LWE-2000-2813-1-1
2.000	2.875	0.313	0.688	LSE-2000-2875-1-1
2.000	2.875	0.315	0.591	MLE-2000-2875-B-1
2.000	2.875	0.315	0.669	LWE-2000-2875-1-1
2.000	2.938	0.313	0.688	LSE-2000-2938-1-1
2.000	2.938	0.313	0.688	FSE-2000-2938-1-1
2.000	2.938	0.315	0.591	MLE-2000-2938-B-1
2.000	2.938	0.315	0.669	LWE-2000-2938-1-1
2.000	2.938	0.562	0.562	LNE-2000-2938-1-1
2.000	2.938	0.591	0.591	FNE-2000-2938-1-1
2.000	3.000	0.313	0.688	LSE-2000-3000-1-1
2.000	3.000	0.313	0.688	FSE-2000-3000-1-1
2.000	3.000	0.315	0.591	MLE-2000-3000-B-1
2.000	3.000	0.315	0.669	LWE-2000-3000-1-1
2.000	3.000	0.562	0.562	LNE-2000-3000-1-1
2.000	3.000	0.591	0.591	FNE-2000-3000-1-1
2.000	3.062	0.313	0.688	LSE-2000-3062-1-1
2.000	3.062	0.313	0.688	FSE-2000-3062-1-1
2.000	3.062	0.562	0.562	LNE-2000-3062-1-1
2.000	3.062	0.591	0.591	FNE-2000-3062-1-1
2.000	3.063	0.315	0.591	MLE-2000-3063-B-1
2.000	3.063	0.315	0.669	LWE-2000-3063-1-1
2.000	3.125	0.313	0.688	LSE-2000-3125-1-1
2.000	3.125	0.313	0.688	FSE-2000-3125-1-1
2.000	3.125	0.315	0.591	MLE-2000-3125-B-1
2.000	3.125	0.315	0.669	LWE-2000-3125-1-1
2.000	3.125	0.562	0.562	LNE-2000-3125-1-1
2.000	3.125	0.591	0.591	FNE-2000-3125-1-1
2.000	3.188	0.313	0.688	LSE-2000-3188-1-1
2.000	3.188	0.313	0.688	FSE-2000-3188-1-1
2.000	3.188	0.315	0.591	MLE-2000-3188-B-1
2.000	3.188	0.315	0.669	LWE-2000-3188-1-1
2.000	3.188	0.562	0.562	LNE-2000-3188-1-1
2.000	3.188	0.591	0.591	FNE-2000-3188-1-1
2.000	3.250	0.313	0.688	LSE-2000-3250-1-1
2.000	3.250	0.313	0.688	FSE-2000-3250-1-1
2.000	3.250	0.315	0.591	MLE-2000-3250-B-1
2.000	3.250	0.315	0.669	LWE-2000-3250-1-1
2.000	3.250	0.562	0.562	LNE-2000-3250-1-1
2.000	3.250	0.591	0.591	FNE-2000-3250-1-1
2.000	3.312	0.313	0.688	LSE-2000-3312-1-1
2.000	3.312	0.313	0.688	FSE-2000-3312-1-1
2.000	3.312	0.562	0.562	LNE-2000-3312-1-1
2.000	3.312	0.591	0.591	FNE-2000-3312-1-1
2.000	3.313	0.315	0.591	MLE-2000-3313-B-1
2.000	3.313	0.315	0.669	LWE-2000-3313-1-1
2.000	3.313	0.315	0.688	LSE-2000-3375-1-1
2.000	3.375	0.313	0.688	LSE-2000-3375-1-1
2.000	3.375	0.313	0.688	FSE-2000-3375-1-1
2.000	3.375	0.315	0.591	MLE-2000-3375-B-1
2.000	3.375	0.315	0.669	LWE-2000-3375-1-1
2.000	3.375	0.562	0.562	LNE-2000-3375-1-1
2.000	3.375	0.591	0.591	FNE-2000-3375-1-1
2.000	3.438	0.313	0.688	LSE-2000-3438-1-1
2.000	3.438	0.313	0.688	FSE-2000-3438-1-1
2.000	3.438	0.315	0.591	MLE-2000-3438-B-1

See Section 4 for seal part number prefix description.

03/03/06



2.000 to 2.125

Shaft Dia.	Bore Dia.	Total In Bore Depth	Total Seal Width	ProTech Part Number
2.000	3.438	0.315	0.669	LWE-2000-3438-1-1
2.000	3.438	0.562	0.562	LNE-2000-3438-1-1
2.000	3.438	0.591	0.591	FNE-2000-3438-1-1
2.000	3.500	0.313	0.688	LSE-2000-3500-1-1
2.000	3.500	0.313	0.688	FSE-2000-3500-1-1
2.000	3.500	0.315	0.591	MLE-2000-3500-B-1
2.000	3.500	0.315	0.669	LWE-2000-3500-1-1
2.000	3.500	0.562	0.562	LNE-2000-3500-1-1
2.000	3.500	0.591	0.591	FNE-2000-3500-1-1
2.062	2.687	0.313	0.688	LSE-2062-2687-1-1
2.062	2.750	0.313	0.688	LSE-2062-2750-1-1
2.062	2.812	0.313	0.688	LSE-2062-2812-1-1
2.062	2.875	0.313	0.688	LSE-2062-2875-1-1
2.062	2.937	0.313	0.688	LSE-2062-2937-1-1
2.062	3.000	0.313	0.688	LSE-2062-3000-1-1
2.062	3.062	0.313	0.688	LSE-2062-3062-1-1
2.062	3.125	0.313	0.688	LSE-2062-3125-1-1
2.062	3.187	0.313	0.688	LSE-2062-3187-1-1
2.062	3.250	0.313	0.688	LSE-2062-3250-1-1
2.062	3.312	0.313	0.688	LSE-2062-3312-1-1
2.062	3.375	0.313	0.688	LSE-2062-3375-1-1
2.062	3.437	0.313	0.688	LSE-2062-3437-1-1
2.062	3.500	0.313	0.688	LSE-2062-3500-1-1
2.062	3.562	0.313	0.688	LSE-2062-3562-1-1
2.063	2.563	0.315	0.591	MLE-2063-2563-B-1
2.063	2.563	0.315	0.669	LWE-2063-2563-1-1
2.063	2.625	0.315	0.591	MLE-2063-2625-B-1
2.063	2.625	0.315	0.669	LWE-2063-2625-1-1
2.063	2.688	0.315	0.591	MLE-2063-2688-B-1
2.063	2.688	0.315	0.669	LWE-2063-2688-1-1
2.063	2.750	0.315	0.591	MLE-2063-2750-B-1
2.063	2.750	0.315	0.669	LWE-2063-2750-1-1
2.063	2.812	0.313	0.688	FSE-2063-2812-1-1
2.063	2.812	0.562	0.562	LNE-2063-2812-1-1
2.063	2.812	0.591	0.591	FNE-2063-2812-1-1
2.063	2.813	0.315	0.591	MLE-2063-2813-B-1
2.063	2.813	0.315	0.669	LWE-2063-2813-1-1
2.063	2.875	0.313	0.688	FSE-2063-2875-1-1
2.063	2.875	0.315	0.591	MLE-2063-2875-B-1
2.063	2.875	0.315	0.669	LWE-2063-2875-1-1
2.063	2.875	0.562	0.562	LNE-2063-2875-1-1
2.063	2.875	0.591	0.591	FNE-2063-2875-1-1
2.063	2.938	0.313	0.688	FSE-2063-2938-1-1
2.063	2.938	0.315	0.591	MLE-2063-2938-B-1
2.063	2.938	0.315	0.669	LWE-2063-2938-1-1
2.063	2.938	0.562	0.562	LNE-2063-2938-1-1
2.063	2.938	0.591	0.591	FNE-2063-2938-1-1
2.063	3.000	0.313	0.688	FSE-2063-3000-1-1
2.063	3.000	0.315	0.591	MLE-2063-3000-B-1
2.063	3.000	0.315	0.669	LWE-2063-3000-1-1
2.063	3.000	0.562	0.562	LNE-2063-3000-1-1
2.063	3.000	0.591	0.591	FNE-2063-3000-1-1
2.063	3.063	0.313	0.688	FSE-2063-3063-1-1
2.063	3.063	0.315	0.591	MLE-2063-3063-B-1
2.063	3.063	0.315	0.669	LWE-2063-3063-1-1
2.063	3.063	0.562	0.562	LNE-2063-3063-1-1
2.063	3.063	0.591	0.591	FNE-2063-3063-1-1
2.063	3.125	0.313	0.688	FSE-2063-3125-1-1
2.063	3.125	0.315	0.591	MLE-2063-3125-B-1
2.063	3.125	0.315	0.669	LWE-2063-3125-1-1
2.063	3.125	0.562	0.562	LNE-2063-3125-1-1
2.063	3.125	0.591	0.591	FNE-2063-3125-1-1
2.063	3.188	0.313	0.688	FSE-2063-3188-1-1
2.063	3.188	0.315	0.591	MLE-2063-3188-B-1
2.063	3.188	0.315	0.669	LWE-2063-3188-1-1
2.063	3.188	0.562	0.562	LNE-2063-3188-1-1

Shaft Dia.	Bore Dia.	Total In Bore Depth	Total Seal Width	ProTech Part Number
2.063	3.188	0.591	0.591	FNE-2063-3188-1-1
2.063	3.250	0.313	0.688	FSE-2063-3250-1-1
2.063	3.250	0.315	0.591	MLE-2063-3250-B-1
2.063	3.250	0.315	0.669	LWE-2063-3250-1-1
2.063	3.250	0.562	0.562	LNE-2063-3250-1-1
2.063	3.250	0.591	0.591	FNE-2063-3250-1-1
2.063	3.313	0.313	0.688	FSE-2063-3313-1-1
2.063	3.313	0.315	0.591	MLE-2063-3313-B-1
2.063	3.313	0.315	0.669	LWE-2063-3313-1-1
2.063	3.313	0.562	0.562	LNE-2063-3313-1-1
2.063	3.313	0.591	0.591	FNE-2063-3313-1-1
2.063	3.375	0.313	0.688	FSE-2063-3375-1-1
2.063	3.375	0.315	0.591	MLE-2063-3375-B-1
2.063	3.375	0.315	0.669	LWE-2063-3375-1-1
2.063	3.375	0.562	0.562	LNE-2063-3375-1-1
2.063	3.375	0.591	0.591	FNE-2063-3375-1-1
2.063	3.438	0.313	0.688	FSE-2063-3438-1-1
2.063	3.438	0.315	0.591	MLE-2063-3438-B-1
2.063	3.438	0.315	0.669	LWE-2063-3438-1-1
2.063	3.438	0.562	0.562	LNE-2063-3438-1-1
2.063	3.438	0.591	0.591	FNE-2063-3438-1-1
2.063	3.500	0.313	0.688	FSE-2063-3500-1-1
2.063	3.500	0.315	0.591	MLE-2063-3500-B-1
2.063	3.500	0.315	0.669	LWE-2063-3500-1-1
2.063	3.500	0.562	0.562	LNE-2063-3500-1-1
2.063	3.500	0.591	0.591	FNE-2063-3500-1-1
2.063	3.563	0.313	0.688	FSE-2063-3563-1-1
2.063	3.563	0.315	0.591	MLE-2063-3563-B-1
2.063	3.563	0.315	0.669	LWE-2063-3563-1-1
2.063	3.563	0.562	0.562	LNE-2063-3563-1-1
2.063	3.563	0.591	0.591	FNE-2063-3563-1-1
2.125	2.625	0.315	0.591	MLE-2125-2625-B-1
2.125	2.625	0.315	0.669	LWE-2125-2625-1-1
2.125	2.688	0.315	0.591	MLE-2125-2688-B-1
2.125	2.688	0.315	0.669	LWE-2125-2688-1-1
2.125	2.750	0.313	0.688	LSE-2125-2750-1-1
2.125	2.750	0.315	0.591	MLE-2125-2750-B-1
2.125	2.750	0.315	0.669	LWE-2125-2750-1-1
2.125	2.812	0.313	0.688	LSE-2125-2812-1-1
2.125	2.813	0.315	0.591	MLE-2125-2813-B-1
2.125	2.813	0.315	0.669	LWE-2125-2813-1-1
2.125	2.875	0.313	0.688	LSE-2125-2875-1-1
2.125	2.875	0.313	0.688	FSE-2125-2875-1-1
2.125	2.875	0.315	0.591	MLE-2125-2875-B-1
2.125	2.875	0.315	0.669	LWE-2125-2875-1-1
2.125	2.875	0.562	0.562	LNE-2125-2875-1-1
2.125	2.875	0.591	0.591	FNE-2125-2875-1-1
2.125	2.938	0.313	0.688	FSE-2125-2938-1-1
2.125	2.938	0.315	0.591	MLE-2125-2938-B-1
2.125	2.938	0.315	0.669	LWE-2125-2938-1-1
2.125	2.938	0.562	0.562	LNE-2125-2938-1-1
2.125	2.938	0.591	0.591	FNE-2125-2938-1-1
2.125	2.938	0.313	0.688	LSE-2125-2938-1-1
2.125	2.938	0.315	0.591	MLE-2125-2938-B-1
2.125	2.938	0.315	0.669	LWE-2125-2938-1-1
2.125	2.938	0.562	0.562	LNE-2125-2938-1-1
2.125	2.938	0.591	0.591	FNE-2125-2938-1-1
2.125	3.000	0.313	0.688	LSE-2125-3000-1-1
2.125	3.000	0.313	0.688	FSE-2125-3000-1-1
2.125	3.000	0.315	0.591	MLE-2125-3000-B-1
2.125	3.000	0.315	0.669	LWE-2125-3000-1-1
2.125	3.000	0.562	0.562	LNE-2125-3000-1-1
2.125	3.000	0.591	0.591	FNE-2125-3000-1-1
2.125	3.063	0.313	0.688	FSE-2125-3063-1-1
2.125	3.063	0.313	0.688	FSE-2125-3063-1-1
2.125	3.063	0.315	0.591	MLE-2125-3063-B-1
2.125	3.063	0.315	0.669	LWE-2125-3063-1-1
2.125	3.063	0.562	0.562	LNE-2125-3063-1-1
2.125	3.063	0.591	0.591	FNE-2125-3063-1-1
2.125	3.125	0.313	0.688	LSE-2125-3125-1-1



See **Section 4** for seal part number prefix description.

03/03/06



Shaft Dia.	Bore Dia.	Total In Bore Depth	Total Seal Width	ProTech Part Number
2.125	3.125	0.313	0.688	FSE-2125-3125-1-1
2.125	3.125	0.315	0.591	MLE-2125-3125-B-1
2.125	3.125	0.315	0.669	LWE-2125-3125-1-1
2.125	3.125	0.562	0.562	LNE-2125-3125-1-1
2.125	3.125	0.591	0.591	FNE-2125-3125-1-1
2.125	3.188	0.313	0.688	LSE-2125-3188-1-1
2.125	3.188	0.313	0.688	FSE-2125-3188-1-1
2.125	3.188	0.315	0.591	MLE-2125-3188-B-1
2.125	3.188	0.315	0.669	LWE-2125-3188-1-1
2.125	3.188	0.562	0.562	LNE-2125-3188-1-1
2.125	3.188	0.591	0.591	FNE-2125-3188-1-1
2.125	3.250	0.313	0.688	LSE-2125-3250-1-1
2.125	3.250	0.313	0.688	FSE-2125-3250-1-1
2.125	3.250	0.315	0.591	MLE-2125-3250-B-1
2.125	3.250	0.315	0.669	LWE-2125-3250-1-1
2.125	3.250	0.562	0.562	LNE-2125-3250-1-1
2.125	3.250	0.591	0.591	FNE-2125-3250-1-1
2.125	3.312	0.313	0.688	LSE-2125-3312-1-1
2.125	3.313	0.313	0.688	FSE-2125-3313-1-1
2.125	3.313	0.315	0.591	MLE-2125-3313-B-1
2.125	3.313	0.315	0.669	LWE-2125-3313-1-1
2.125	3.313	0.562	0.562	LNE-2125-3313-1-1
2.125	3.313	0.591	0.591	FNE-2125-3313-1-1
2.125	3.375	0.313	0.688	LSE-2125-3375-1-1
2.125	3.375	0.313	0.688	FSE-2125-3375-1-1
2.125	3.375	0.315	0.591	MLE-2125-3375-B-1
2.125	3.375	0.315	0.669	LWE-2125-3375-1-1
2.125	3.375	0.562	0.562	LNE-2125-3375-1-1
2.125	3.375	0.591	0.591	FNE-2125-3375-1-1
2.125	3.438	0.313	0.688	LSE-2125-3438-1-1
2.125	3.438	0.313	0.688	FSE-2125-3438-1-1
2.125	3.438	0.315	0.591	MLE-2125-3438-B-1
2.125	3.438	0.315	0.669	LWE-2125-3438-1-1
2.125	3.438	0.562	0.562	LNE-2125-3438-1-1
2.125	3.438	0.591	0.591	FNE-2125-3438-1-1
2.125	3.500	0.313	0.688	LSE-2125-3500-1-1
2.125	3.500	0.313	0.688	FSE-2125-3500-1-1
2.125	3.500	0.315	0.591	MLE-2125-3500-B-1
2.125	3.500	0.315	0.669	LWE-2125-3500-1-1
2.125	3.500	0.562	0.562	LNE-2125-3500-1-1
2.125	3.500	0.591	0.591	FNE-2125-3500-1-1
2.125	3.563	0.313	0.688	LSE-2125-3563-1-1
2.125	3.563	0.313	0.688	FSE-2125-3563-1-1
2.125	3.563	0.315	0.591	MLE-2125-3563-B-1
2.125	3.563	0.315	0.669	LWE-2125-3563-1-1
2.125	3.563	0.562	0.562	LNE-2125-3563-1-1
2.125	3.563	0.591	0.591	FNE-2125-3563-1-1
2.125	3.625	0.313	0.688	LSE-2125-3625-1-1
2.125	3.625	0.313	0.688	FSE-2125-3625-1-1
2.125	3.625	0.315	0.591	MLE-2125-3625-B-1
2.125	3.625	0.315	0.669	LWE-2125-3625-1-1
2.125	3.625	0.562	0.562	LNE-2125-3625-1-1
2.125	3.625	0.591	0.591	FNE-2125-3625-1-1
2.188	2.688	0.315	0.591	MLE-2188-2688-B-1
2.188	2.688	0.315	0.669	LWE-2188-2688-1-1
2.188	2.750	0.315	0.591	MLE-2188-2750-B-1
2.188	2.750	0.315	0.669	LWE-2188-2750-1-1
2.188	2.813	0.313	0.688	LSE-2188-2813-1-1
2.188	2.813	0.315	0.591	MLE-2188-2813-B-1
2.188	2.813	0.315	0.669	LWE-2188-2813-1-1
2.188	2.875	0.313	0.688	LSE-2188-2875-1-1
2.188	2.875	0.315	0.591	MLE-2188-2875-B-1
2.188	2.875	0.315	0.669	LWE-2188-2875-1-1
2.188	2.938	0.313	0.688	LSE-2188-2938-1-1
2.188	2.938	0.313	0.688	FSE-2188-2938-1-1
2.188	2.938	0.315	0.591	MLE-2188-2938-B-1

Shaft Dia.	Bore Dia.	Total In Bore Depth	Total Seal Width	ProTech Part Number
2.188	2.938	0.315	0.669	LWE-2188-2938-1-1
2.188	2.938	0.562	0.562	LNE-2188-2938-1-1
2.188	2.938	0.591	0.591	FNE-2188-2938-1-1
2.188	3.000	0.313	0.688	LSE-2188-3000-1-1
2.188	3.000	0.313	0.688	FSE-2188-3000-1-1
2.188	3.000	0.315	0.591	MLE-2188-3000-B-1
2.188	3.000	0.315	0.669	LWE-2188-3000-1-1
2.188	3.000	0.562	0.562	LNE-2188-3000-1-1
2.188	3.000	0.591	0.591	FNE-2188-3000-1-1
2.188	3.062	0.313	0.688	FSE-2188-3062-1-1
2.188	3.062	0.562	0.562	LNE-2188-3062-1-1
2.188	3.062	0.591	0.591	FNE-2188-3062-1-1
2.188	3.063	0.313	0.688	LSE-2188-3063-1-1
2.188	3.063	0.315	0.591	MLE-2188-3063-B-1
2.188	3.063	0.315	0.669	LWE-2188-3063-1-1
2.188	3.125	0.313	0.688	LSE-2188-3125-1-1
2.188	3.125	0.313	0.688	FSE-2188-3125-1-1
2.188	3.125	0.315	0.591	MLE-2188-3125-B-1
2.188	3.125	0.315	0.669	LWE-2188-3125-1-1
2.188	3.125	0.562	0.562	LNE-2188-3125-1-1
2.188	3.125	0.591	0.591	FNE-2188-3125-1-1
2.188	3.188	0.313	0.688	LSE-2188-3188-1-1
2.188	3.188	0.313	0.688	FSE-2188-3188-1-1
2.188	3.188	0.315	0.591	MLE-2188-3188-B-1
2.188	3.188	0.315	0.669	LWE-2188-3188-1-1
2.188	3.188	0.562	0.562	LNE-2188-3188-1-1
2.188	3.188	0.591	0.591	FNE-2188-3188-1-1
2.188	3.250	0.313	0.688	LSE-2188-3250-1-1
2.188	3.250	0.313	0.688	FSE-2188-3250-1-1
2.188	3.250	0.315	0.591	MLE-2188-3250-B-1
2.188	3.250	0.315	0.669	LWE-2188-3250-1-1
2.188	3.250	0.562	0.562	LNE-2188-3250-1-1
2.188	3.250	0.591	0.591	FNE-2188-3250-1-1
2.188	3.313	0.313	0.688	LSE-2188-3313-1-1
2.188	3.313	0.313	0.688	FSE-2188-3313-1-1
2.188	3.313	0.315	0.591	MLE-2188-3313-B-1
2.188	3.313	0.315	0.669	LWE-2188-3313-1-1
2.188	3.313	0.562	0.562	LNE-2188-3313-1-1
2.188	3.313	0.591	0.591	FNE-2188-3313-1-1
2.188	3.375	0.313	0.688	LSE-2188-3375-1-1
2.188	3.375	0.313	0.688	FSE-2188-3375-1-1
2.188	3.375	0.315	0.591	MLE-2188-3375-B-1
2.188	3.375	0.315	0.669	LWE-2188-3375-1-1
2.188	3.375	0.562	0.562	LNE-2188-3375-1-1
2.188	3.375	0.591	0.591	FNE-2188-3375-1-1
2.188	3.438	0.313	0.688	LSE-2188-3438-1-1
2.188	3.438	0.313	0.688	FSE-2188-3438-1-1
2.188	3.438	0.315	0.591	MLE-2188-3438-B-1
2.188	3.438	0.315	0.669	LWE-2188-3438-1-1
2.188	3.438	0.562	0.562	LNE-2188-3438-1-1
2.188	3.438	0.591	0.591	FNE-2188-3438-1-1
2.188	3.500	0.313	0.688	LSE-2188-3500-1-1
2.188	3.500	0.313	0.688	FSE-2188-3500-1-1
2.188	3.500	0.315	0.591	MLE-2188-3500-B-1
2.188	3.500	0.315	0.669	LWE-2188-3500-1-1
2.188	3.500	0.562	0.562	LNE-2188-3500-1-1
2.188	3.500	0.591	0.591	FNE-2188-3500-1-1
2.188	3.562	0.313	0.688	LSE-2188-3562-1-1
2.188	3.562	0.562	0.562	LNE-2188-3562-1-1
2.188	3.562	0.591	0.591	FNE-2188-3562-1-1
2.188	3.563	0.313	0.688	LSE-2188-3563-1-1
2.188	3.563	0.315	0.591	MLE-2188-3563-B-1
2.188	3.563	0.315	0.669	LWE-2188-3563-1-1
2.188	3.625	0.313	0.688	LSE-2188-3625-1-1
2.188	3.625	0.313	0.688	FSE-2188-3625-1-1
2.188	3.625	0.315	0.591	MLE-2188-3625-B-1

F

See Section 4 for seal part number prefix description.

03/03/06



2.188 to 2.313

Shaft Dia.	Bore Dia.	Total In Bore Depth	Total Seal Width	ProTech Part Number
2.188	3.625	0.315	0.669	LWE-2188-3625-1-1
2.188	3.625	0.562	0.562	LNE-2188-3625-1-1
2.188	3.625	0.591	0.591	FNE-2188-3625-1-1
2.188	3.688	0.313	0.688	LSE-2188-3688-1-1
2.188	3.688	0.313	0.688	FSE-2188-3688-1-1
2.188	3.688	0.315	0.591	MLE-2188-3688-B-1
2.188	3.688	0.315	0.669	LWE-2188-3688-1-1
2.188	3.688	0.562	0.562	LNE-2188-3688-1-1
2.188	3.688	0.591	0.591	FNE-2188-3688-1-1
2.250	2.750	0.315	0.591	MLE-2250-2750-B-1
2.250	2.750	0.315	0.669	LWE-2250-2750-1-1
2.250	2.813	0.315	0.591	MLE-2250-2813-B-1
2.250	2.813	0.315	0.669	LWE-2250-2813-1-1
2.250	2.875	0.313	0.688	LSE-2250-2875-1-1
2.250	2.875	0.315	0.591	MLE-2250-2875-B-1
2.250	2.875	0.315	0.669	LWE-2250-2875-1-1
2.250	2.938	0.313	0.688	LSE-2250-2938-1-1
2.250	2.938	0.315	0.591	MLE-2250-2938-B-1
2.250	2.938	0.315	0.669	LWE-2250-2938-1-1
2.250	3.000	0.313	0.688	LSE-2250-3000-1-1
2.250	3.000	0.313	0.688	FSE-2250-3000-1-1
2.250	3.000	0.315	0.591	MLE-2250-3000-B-1
2.250	3.000	0.315	0.669	LWE-2250-3000-1-1
2.250	3.000	0.562	0.562	LNE-2250-3000-1-1
2.250	3.000	0.591	0.591	FNE-2250-3000-1-1
2.250	3.062	0.313	0.688	LSE-2250-3062-1-1
2.250	3.063	0.313	0.688	FSE-2250-3063-1-1
2.250	3.063	0.315	0.591	MLE-2250-3063-B-1
2.250	3.063	0.315	0.669	LWE-2250-3063-1-1
2.250	3.063	0.562	0.562	LNE-2250-3063-1-1
2.250	3.063	0.591	0.591	FNE-2250-3063-1-1
2.250	3.125	0.313	0.688	LSE-2250-3125-1-1
2.250	3.125	0.313	0.688	FSE-2250-3125-1-1
2.250	3.125	0.315	0.591	MLE-2250-3125-B-1
2.250	3.125	0.315	0.669	LWE-2250-3125-1-1
2.250	3.125	0.562	0.562	LNE-2250-3125-1-1
2.250	3.125	0.591	0.591	FNE-2250-3125-1-1
2.250	3.188	0.313	0.688	LSE-2250-3188-1-1
2.250	3.188	0.313	0.688	FSE-2250-3188-1-1
2.250	3.188	0.315	0.591	MLE-2250-3188-B-1
2.250	3.188	0.315	0.669	LWE-2250-3188-1-1
2.250	3.188	0.562	0.562	LNE-2250-3188-1-1
2.250	3.188	0.591	0.591	FNE-2250-3188-1-1
2.250	3.250	0.313	0.688	LSE-2250-3250-1-1
2.250	3.250	0.313	0.688	FSE-2250-3250-1-1
2.250	3.250	0.315	0.591	MLE-2250-3250-B-1
2.250	3.250	0.315	0.669	LWE-2250-3250-1-1
2.250	3.250	0.562	0.562	LNE-2250-3250-1-1
2.250	3.250	0.591	0.591	FNE-2250-3250-1-1
2.250	3.312	0.313	0.688	LSE-2250-3312-1-1
2.250	3.313	0.313	0.688	FSE-2250-3313-1-1
2.250	3.313	0.315	0.591	MLE-2250-3313-B-1
2.250	3.313	0.315	0.669	LWE-2250-3313-1-1
2.250	3.313	0.562	0.562	LNE-2250-3313-1-1
2.250	3.313	0.591	0.591	FNE-2250-3313-1-1
2.250	3.375	0.313	0.688	LSE-2250-3375-1-1
2.250	3.375	0.313	0.688	FSE-2250-3375-1-1
2.250	3.375	0.315	0.591	MLE-2250-3375-B-1
2.250	3.375	0.315	0.669	LWE-2250-3375-1-1
2.250	3.375	0.562	0.562	LNE-2250-3375-1-1
2.250	3.375	0.591	0.591	FNE-2250-3375-1-1
2.250	3.437	0.313	0.688	LSE-2250-3437-1-1
2.250	3.438	0.313	0.688	FSE-2250-3438-1-1
2.250	3.438	0.315	0.591	MLE-2250-3438-B-1
2.250	3.438	0.315	0.669	LWE-2250-3438-1-1
2.250	3.438	0.562	0.562	LNE-2250-3438-1-1

Shaft Dia.	Bore Dia.	Total In Bore Depth	Total Seal Width	ProTech Part Number
2.250	3.438	0.591	0.591	FNE-2250-3438-1-1
2.250	3.500	0.313	0.688	LSE-2250-3500-1-1
2.250	3.500	0.313	0.688	FSE-2250-3500-1-1
2.250	3.500	0.315	0.591	MLE-2250-3500-B-1
2.250	3.500	0.315	0.669	LWE-2250-3500-1-1
2.250	3.500	0.562	0.562	LNE-2250-3500-1-1
2.250	3.500	0.591	0.591	FNE-2250-3500-1-1
2.250	3.562	0.313	0.688	LSE-2250-3562-1-1
2.250	3.563	0.313	0.688	FSE-2250-3563-1-1
2.250	3.563	0.315	0.591	MLE-2250-3563-B-1
2.250	3.563	0.315	0.669	LWE-2250-3563-1-1
2.250	3.563	0.562	0.562	LNE-2250-3563-1-1
2.250	3.563	0.591	0.591	FNE-2250-3563-1-1
2.250	3.625	0.313	0.688	LSE-2250-3625-1-1
2.250	3.625	0.313	0.688	FSE-2250-3625-1-1
2.250	3.625	0.315	0.591	MLE-2250-3625-B-1
2.250	3.625	0.315	0.669	LWE-2250-3625-1-1
2.250	3.625	0.562	0.562	LNE-2250-3625-1-1
2.250	3.625	0.591	0.591	FNE-2250-3625-1-1
2.250	3.688	0.313	0.688	LSE-2250-3688-1-1
2.250	3.688	0.313	0.688	FSE-2250-3688-1-1
2.250	3.688	0.315	0.591	MLE-2250-3688-B-1
2.250	3.688	0.315	0.669	LWE-2250-3688-1-1
2.250	3.688	0.562	0.562	LNE-2250-3688-1-1
2.250	3.688	0.591	0.591	FNE-2250-3688-1-1
2.250	3.750	0.313	0.688	LSE-2250-3750-1-1
2.250	3.750	0.313	0.688	FSE-2250-3750-1-1
2.250	3.750	0.315	0.591	MLE-2250-3750-B-1
2.250	3.750	0.315	0.669	LWE-2250-3750-1-1
2.250	3.750	0.562	0.562	LNE-2250-3750-1-1
2.250	3.750	0.591	0.591	FNE-2250-3750-1-1
2.313	2.813	0.315	0.591	MLE-2313-2813-B-1
2.313	2.813	0.315	0.669	LWE-2313-2813-1-1
2.313	2.875	0.315	0.591	MLE-2313-2875-B-1
2.313	2.875	0.315	0.669	LWE-2313-2875-1-1
2.313	2.938	0.313	0.688	LSE-2313-2938-1-1
2.313	2.938	0.315	0.591	MLE-2313-2938-B-1
2.313	2.938	0.315	0.669	LWE-2313-2938-1-1
2.313	3.000	0.313	0.688	LSE-2313-3000-1-1
2.313	3.000	0.313	0.688	FSE-2313-3000-1-1
2.313	3.000	0.315	0.591	MLE-2313-3000-B-1
2.313	3.000	0.315	0.669	LWE-2313-3000-1-1
2.313	3.000	0.562	0.562	LNE-2313-3000-1-1
2.313	3.000	0.591	0.591	FNE-2313-3000-1-1
2.313	3.063	0.313	0.688	LSE-2313-3063-1-1
2.313	3.063	0.313	0.688	FSE-2313-3063-1-1
2.313	3.063	0.315	0.591	MLE-2313-3063-B-1
2.313	3.063	0.315	0.669	LWE-2313-3063-1-1
2.313	3.063	0.562	0.562	LNE-2313-3063-1-1
2.313	3.063	0.591	0.591	FNE-2313-3063-1-1
2.313	3.125	0.313	0.688	LSE-2313-3125-1-1
2.313	3.125	0.313	0.688	FSE-2313-3125-1-1
2.313	3.125	0.315	0.591	MLE-2313-3125-B-1
2.313	3.125	0.315	0.669	LWE-2313-3125-1-1
2.313	3.125	0.562	0.562	LNE-2313-3125-1-1
2.313	3.125	0.591	0.591	FNE-2313-3125-1-1
2.313	3.188	0.313	0.688	LSE-2313-3188-1-1
2.313	3.188	0.313	0.688	FSE-2313-3188-1-1
2.313	3.188	0.315	0.591	MLE-2313-3188-B-1
2.313	3.188	0.315	0.669	LWE-2313-3188-1-1
2.313	3.188	0.562	0.562	LNE-2313-3188-1-1
2.313	3.188	0.591	0.591	FNE-2313-3188-1-1
2.313	3.250	0.313	0.688	LSE-2313-3250-1-1
2.313	3.250	0.313	0.688	FSE-2313-3250-1-1
2.313	3.250	0.315	0.591	MLE-2313-3250-B-1
2.313	3.250	0.315	0.669	LWE-2313-3250-1-1
2.313	3.250	0.562	0.562	LNE-2313-3250-1-1
2.313	3.250	0.591	0.591	FNE-2313-3250-1-1



See Section 4 for seal part number prefix description.

03/03/06



Shaft Dia.	Bore Dia.	Total In Bore Depth	Total Seal Width	ProTech Part Number
2.313	3.250	0.562	0.562	LNE-2313-3250-1-1
2.313	3.250	0.591	0.591	FNE-2313-3250-1-1
2.313	3.313	0.313	0.688	LSE-2313-3313-1-1
2.313	3.313	0.313	0.688	FSE-2313-3313-1-1
2.313	3.313	0.315	0.591	MLE-2313-3313-B-1
2.313	3.313	0.315	0.669	LWE-2313-3313-1-1
2.313	3.313	0.562	0.562	LNE-2313-3313-1-1
2.313	3.313	0.591	0.591	FNE-2313-3313-1-1
2.313	3.375	0.313	0.688	LSE-2313-3375-1-1
2.313	3.375	0.313	0.688	FSE-2313-3375-1-1
2.313	3.375	0.315	0.591	MLE-2313-3375-B-1
2.313	3.375	0.315	0.669	LWE-2313-3375-1-1
2.313	3.375	0.562	0.562	LNE-2313-3375-1-1
2.313	3.375	0.591	0.591	FNE-2313-3375-1-1
2.313	3.438	0.313	0.688	LSE-2313-3438-1-1
2.313	3.438	0.313	0.688	FSE-2313-3438-1-1
2.313	3.438	0.315	0.591	MLE-2313-3438-B-1
2.313	3.438	0.315	0.669	LWE-2313-3438-1-1
2.313	3.438	0.562	0.562	LNE-2313-3438-1-1
2.313	3.438	0.591	0.591	FNE-2313-3438-1-1
2.313	3.500	0.313	0.688	LSE-2313-3500-1-1
2.313	3.500	0.313	0.688	FSE-2313-3500-1-1
2.313	3.500	0.315	0.591	MLE-2313-3500-B-1
2.313	3.500	0.315	0.669	LWE-2313-3500-1-1
2.313	3.500	0.562	0.562	LNE-2313-3500-1-1
2.313	3.500	0.591	0.591	FNE-2313-3500-1-1
2.313	3.563	0.313	0.688	LSE-2313-3563-1-1
2.313	3.563	0.313	0.688	FSE-2313-3563-1-1
2.313	3.563	0.315	0.591	MLE-2313-3563-B-1
2.313	3.563	0.315	0.669	LWE-2313-3563-1-1
2.313	3.563	0.562	0.562	LNE-2313-3563-1-1
2.313	3.563	0.591	0.591	FNE-2313-3563-1-1
2.313	3.625	0.313	0.688	LSE-2313-3625-1-1
2.313	3.625	0.313	0.688	FSE-2313-3625-1-1
2.313	3.625	0.315	0.591	MLE-2313-3625-B-1
2.313	3.625	0.315	0.669	LWE-2313-3625-1-1
2.313	3.625	0.562	0.562	LNE-2313-3625-1-1
2.313	3.625	0.591	0.591	FNE-2313-3625-1-1
2.313	3.688	0.313	0.688	LSE-2313-3688-1-1
2.313	3.688	0.313	0.688	FSE-2313-3688-1-1
2.313	3.688	0.315	0.591	MLE-2313-3688-B-1
2.313	3.688	0.315	0.669	LWE-2313-3688-1-1
2.313	3.688	0.562	0.562	LNE-2313-3688-1-1
2.313	3.688	0.591	0.591	FNE-2313-3688-1-1
2.313	3.750	0.313	0.688	LSE-2313-3750-1-1
2.313	3.750	0.313	0.688	FSE-2313-3750-1-1
2.313	3.750	0.315	0.591	MLE-2313-3750-B-1
2.313	3.750	0.315	0.669	LWE-2313-3750-1-1
2.313	3.750	0.562	0.562	LNE-2313-3750-1-1
2.313	3.750	0.591	0.591	FNE-2313-3750-1-1
2.313	3.813	0.313	0.688	LSE-2313-3813-1-1
2.313	3.813	0.313	0.688	FSE-2313-3813-1-1
2.313	3.813	0.315	0.591	MLE-2313-3813-B-1
2.313	3.813	0.315	0.669	LWE-2313-3813-1-1
2.313	3.813	0.562	0.562	LNE-2313-3813-1-1
2.313	3.813	0.591	0.591	FNE-2313-3813-1-1
2.375	3.000	0.313	0.688	LSE-2375-3000-1-1
2.375	3.062	0.313	0.688	LSE-2375-3062-1-1
2.375	3.063	0.354	0.630	MLE-2375-3063-B-1
2.375	3.063	0.354	0.709	LWE-2375-3063-1-1
2.375	3.125	0.313	0.688	LSE-2375-3125-1-1
2.375	3.125	0.313	0.688	FSE-2375-3125-1-1
2.375	3.125	0.354	0.630	MLE-2375-3125-B-1
2.375	3.125	0.354	0.709	LWE-2375-3125-1-1
2.375	3.125	0.562	0.562	LNE-2375-3125-1-1
2.375	3.125	0.591	0.591	FNE-2375-3125-1-1

Shaft Dia.	Bore Dia.	Total In Bore Depth	Total Seal Width	ProTech Part Number
2.375	3.188	0.313	0.688	LSE-2375-3188-1-1
2.375	3.188	0.313	0.688	FSE-2375-3188-1-1
2.375	3.188	0.354	0.630	MLE-2375-3188-B-1
2.375	3.188	0.354	0.709	LWE-2375-3188-1-1
2.375	3.188	0.562	0.562	LNE-2375-3188-1-1
2.375	3.188	0.591	0.591	FNE-2375-3188-1-1
2.375	3.250	0.313	0.688	LSE-2375-3250-1-1
2.375	3.250	0.354	0.630	MLE-2375-3250-B-1
2.375	3.250	0.354	0.709	LWE-2375-3250-1-1
2.375	3.312	0.313	0.688	LSE-2375-3312-1-1
2.375	3.313	0.354	0.630	MLE-2375-3313-B-1
2.375	3.313	0.354	0.709	LWE-2375-3313-1-1
2.375	3.375	0.313	0.688	LSE-2375-3375-1-1
2.375	3.375	0.354	0.630	MLE-2375-3375-B-1
2.375	3.375	0.354	0.709	LWE-2375-3375-1-1
2.375	3.438	0.313	0.688	LSE-2375-3438-1-1
2.375	3.438	0.354	0.630	MLE-2375-3438-B-1
2.375	3.438	0.354	0.709	LWE-2375-3438-1-1
2.375	3.500	0.313	0.688	LSE-2375-3500-1-1
2.375	3.500	0.313	0.688	FSE-2375-3500-1-1
2.375	3.500	0.354	0.630	MLE-2375-3500-B-1
2.375	3.500	0.354	0.709	LWE-2375-3500-1-1
2.375	3.500	0.562	0.562	LNE-2375-3500-1-1
2.375	3.500	0.591	0.591	FNE-2375-3500-1-1
2.375	3.562	0.313	0.688	LSE-2375-3562-1-1
2.375	3.563	0.313	0.688	FSE-2375-3563-1-1
2.375	3.563	0.354	0.630	MLE-2375-3563-B-1
2.375	3.563	0.354	0.709	LWE-2375-3563-1-1
2.375	3.563	0.562	0.562	LNE-2375-3563-1-1
2.375	3.563	0.591	0.591	FNE-2375-3563-1-1
2.375	3.625	0.313	0.688	LSE-2375-3625-1-1
2.375	3.625	0.313	0.688	FSE-2375-3625-1-1
2.375	3.625	0.354	0.630	MLE-2375-3625-B-1
2.375	3.625	0.354	0.709	LWE-2375-3625-1-1
2.375	3.625	0.562	0.562	LNE-2375-3625-1-1
2.375	3.625	0.591	0.591	FNE-2375-3625-1-1
2.375	3.688	0.313	0.688	LSE-2375-3688-1-1
2.375	3.688	0.313	0.688	FSE-2375-3688-1-1
2.375	3.688	0.354	0.630	MLE-2375-3688-B-1
2.375	3.688	0.354	0.709	LWE-2375-3688-1-1
2.375	3.688	0.562	0.562	LNE-2375-3688-1-1
2.375	3.688	0.591	0.591	FNE-2375-3688-1-1
2.375	3.750	0.313	0.688	LSE-2375-3750-1-1
2.375	3.750	0.354	0.630	MLE-2375-3750-B-1
2.375	3.750	0.354	0.709	LWE-2375-3750-1-1
2.375	3.750	0.562	0.562	LNE-2375-3750-1-1
2.375	3.750	0.591	0.591	FNE-2375-3750-1-1
2.375	3.812	0.313	0.688	LSE-2375-3812-1-1
2.375	3.813	0.313	0.688	FSE-2375-3813-1-1
2.375	3.813	0.354	0.630	MLE-2375-3813-B-1
2.375	3.813	0.354	0.709	LWE-2375-3813-1-1
2.375	3.813	0.562	0.562	LNE-2375-3813-1-1
2.375	3.813	0.591	0.591	FNE-2375-3813-1-1
2.375	3.875	0.313	0.688	LSE-2375-3875-1-1
2.375	3.875	0.313	0.688	FSE-2375-3875-1-1
2.375	3.875	0.354	0.630	MLE-2375-3875-B-1
2.375	3.875	0.354	0.709	LWE-2375-3875-1-1
2.375	3.875	0.562	0.562	LNE-2375-3875-1-1
2.375	3.875	0.591	0.591	FNE-2375-3875-1-1
2.438	3.063	0.313	0.688	LSE-2438-3063-1-1
2.438	3.125	0.313	0.688	LSE-2438-3125-1-1
2.438	3.125	0.354	0.630	MLE-2438-3125-B-1
2.438	3.125	0.354	0.709	LWE-2438-3125-1-1
2.438	3.188	0.313	0.688	LSE-2438-3188-1-1
2.438	3.188	0.313	0.688	FSE-2438-3188-1-1

F

See Section 4 for seal part number prefix description.

03/03/06



2.438 to 2.500

Shaft Dia.	Bore Dia.	Total In Bore Depth	Total Seal Width	ProTech Part Number
2.438	3.188	0.354	0.630	MLE-2438-3188-B-1
2.438	3.188	0.354	0.709	LWE-2438-3188-1-1
2.438	3.188	0.562	0.562	LNE-2438-3188-1-1
2.438	3.188	0.591	0.591	FNE-2438-3188-1-1
2.438	3.250	0.313	0.688	LSE-2438-3250-1-1
2.438	3.250	0.313	0.688	FSE-2438-3250-1-1
2.438	3.250	0.354	0.630	MLE-2438-3250-B-1
2.438	3.250	0.354	0.709	LWE-2438-3250-1-1
2.438	3.250	0.562	0.562	LNE-2438-3250-1-1
2.438	3.250	0.591	0.591	FNE-2438-3250-1-1
2.438	3.313	0.313	0.688	LSE-2438-3313-1-1
2.438	3.313	0.313	0.688	FSE-2438-3313-1-1
2.438	3.313	0.354	0.630	MLE-2438-3313-B-1
2.438	3.313	0.354	0.709	LWE-2438-3313-1-1
2.438	3.313	0.562	0.562	LNE-2438-3313-1-1
2.438	3.313	0.591	0.591	FNE-2438-3313-1-1
2.438	3.375	0.313	0.688	LSE-2438-3375-1-1
2.438	3.375	0.313	0.688	FSE-2438-3375-1-1
2.438	3.375	0.354	0.630	MLE-2438-3375-B-1
2.438	3.375	0.354	0.709	LWE-2438-3375-1-1
2.438	3.375	0.562	0.562	LNE-2438-3375-1-1
2.438	3.375	0.591	0.591	FNE-2438-3375-1-1
2.438	3.438	0.313	0.688	LSE-2438-3438-1-1
2.438	3.438	0.313	0.688	FSE-2438-3438-1-1
2.438	3.438	0.354	0.630	MLE-2438-3438-B-1
2.438	3.438	0.354	0.709	LWE-2438-3438-1-1
2.438	3.438	0.562	0.562	LNE-2438-3438-1-1
2.438	3.438	0.591	0.591	FNE-2438-3438-1-1
2.438	3.500	0.313	0.688	LSE-2438-3500-1-1
2.438	3.500	0.313	0.688	FSE-2438-3500-1-1
2.438	3.500	0.354	0.630	MLE-2438-3500-B-1
2.438	3.500	0.354	0.709	LWE-2438-3500-1-1
2.438	3.500	0.562	0.562	LNE-2438-3500-1-1
2.438	3.500	0.591	0.591	FNE-2438-3500-1-1
2.438	3.563	0.313	0.688	LSE-2438-3563-1-1
2.438	3.563	0.313	0.688	FSE-2438-3563-1-1
2.438	3.563	0.354	0.630	MLE-2438-3563-B-1
2.438	3.563	0.354	0.709	LWE-2438-3563-1-1
2.438	3.563	0.562	0.562	LNE-2438-3563-1-1
2.438	3.563	0.591	0.591	FNE-2438-3563-1-1
2.438	3.625	0.313	0.688	LSE-2438-3625-1-1
2.438	3.625	0.313	0.688	FSE-2438-3625-1-1
2.438	3.625	0.354	0.630	MLE-2438-3625-B-1
2.438	3.625	0.354	0.709	LWE-2438-3625-1-1
2.438	3.625	0.562	0.562	LNE-2438-3625-1-1
2.438	3.625	0.591	0.591	FNE-2438-3625-1-1
2.438	3.688	0.313	0.688	LSE-2438-3688-1-1
2.438	3.688	0.313	0.688	FSE-2438-3688-1-1
2.438	3.688	0.354	0.630	MLE-2438-3688-B-1
2.438	3.688	0.354	0.709	LWE-2438-3688-1-1
2.438	3.688	0.562	0.562	LNE-2438-3688-1-1
2.438	3.688	0.591	0.591	FNE-2438-3688-1-1
2.438	3.750	0.313	0.688	LSE-2438-3750-1-1
2.438	3.750	0.313	0.688	FSE-2438-3750-1-1
2.438	3.750	0.354	0.630	MLE-2438-3750-B-1
2.438	3.750	0.354	0.709	LWE-2438-3750-1-1
2.438	3.750	0.562	0.562	LNE-2438-3750-1-1
2.438	3.750	0.591	0.591	FNE-2438-3750-1-1
2.438	3.813	0.313	0.688	LSE-2438-3813-1-1
2.438	3.813	0.313	0.688	FSE-2438-3813-1-1
2.438	3.813	0.354	0.630	MLE-2438-3813-B-1
2.438	3.813	0.354	0.709	LWE-2438-3813-1-1
2.438	3.813	0.562	0.562	LNE-2438-3813-1-1
2.438	3.813	0.591	0.591	FNE-2438-3813-1-1
2.438	3.875	0.313	0.688	LSE-2438-3875-1-1
2.438	3.875	0.313	0.688	FSE-2438-3875-1-1

Shaft Dia.	Bore Dia.	Total In Bore Depth	Total Seal Width	ProTech Part Number
2.438	3.875	0.354	0.630	MLE-2438-3875-B-1
2.438	3.875	0.354	0.709	LWE-2438-3875-1-1
2.438	3.875	0.562	0.562	LNE-2438-3875-1-1
2.438	3.875	0.591	0.591	FNE-2438-3875-1-1
2.438	3.938	0.313	0.688	LSE-2438-3938-1-1
2.438	3.938	0.313	0.688	FSE-2438-3938-1-1
2.438	3.938	0.354	0.630	MLE-2438-3938-B-1
2.438	3.938	0.354	0.709	LWE-2438-3938-1-1
2.438	3.938	0.562	0.562	LNE-2438-3938-1-1
2.438	3.938	0.591	0.591	FNE-2438-3938-1-1
2.500	3.125	0.313	0.688	LSE-2500-3125-1-1
2.500	3.188	0.313	0.688	LSE-2500-3188-1-1
2.500	3.188	0.354	0.630	MLE-2500-3188-B-1
2.500	3.188	0.354	0.709	LWE-2500-3188-1-1
2.500	3.250	0.313	0.688	LSE-2500-3250-1-1
2.500	3.250	0.313	0.688	FSE-2500-3250-1-1
2.500	3.250	0.354	0.630	MLE-2500-3250-B-1
2.500	3.250	0.354	0.709	LWE-2500-3250-1-1
2.500	3.250	0.562	0.562	LNE-2500-3250-1-1
2.500	3.250	0.591	0.591	FNE-2500-3250-1-1
2.500	3.313	0.313	0.688	LSE-2500-3313-1-1
2.500	3.313	0.313	0.688	FSE-2500-3313-1-1
2.500	3.313	0.354	0.630	MLE-2500-3313-B-1
2.500	3.313	0.354	0.709	LWE-2500-3313-1-1
2.500	3.313	0.562	0.562	LNE-2500-3313-1-1
2.500	3.313	0.591	0.591	FNE-2500-3313-1-1
2.500	3.375	0.313	0.688	LSE-2500-3375-1-1
2.500	3.375	0.313	0.688	FSE-2500-3375-1-1
2.500	3.375	0.354	0.630	MLE-2500-3375-B-1
2.500	3.375	0.354	0.709	LWE-2500-3375-1-1
2.500	3.375	0.562	0.562	LNE-2500-3375-1-1
2.500	3.375	0.591	0.591	FNE-2500-3375-1-1
2.500	3.438	0.313	0.688	LSE-2500-3438-1-1
2.500	3.438	0.313	0.688	FSE-2500-3438-1-1
2.500	3.438	0.354	0.630	MLE-2500-3438-B-1
2.500	3.438	0.354	0.709	LWE-2500-3438-1-1
2.500	3.438	0.562	0.562	LNE-2500-3438-1-1
2.500	3.438	0.591	0.591	FNE-2500-3438-1-1
2.500	3.500	0.313	0.688	LSE-2500-3500-1-1
2.500	3.500	0.313	0.688	FSE-2500-3500-1-1
2.500	3.500	0.354	0.630	MLE-2500-3500-B-1
2.500	3.500	0.354	0.709	LWE-2500-3500-1-1
2.500	3.500	0.562	0.562	LNE-2500-3500-1-1
2.500	3.500	0.591	0.591	FNE-2500-3500-1-1
2.500	3.563	0.313	0.688	LSE-2500-3563-1-1
2.500	3.563	0.313	0.688	FSE-2500-3563-1-1
2.500	3.563	0.354	0.630	MLE-2500-3563-B-1
2.500	3.563	0.354	0.709	LWE-2500-3563-1-1
2.500	3.563	0.562	0.562	LNE-2500-3563-1-1
2.500	3.563	0.591	0.591	FNE-2500-3563-1-1
2.500	3.625	0.313	0.688	LSE-2500-3625-1-1
2.500	3.625	0.313	0.688	FSE-2500-3625-1-1
2.500	3.625	0.354	0.630	MLE-2500-3625-B-1
2.500	3.625	0.354	0.709	LWE-2500-3625-1-1
2.500	3.625	0.562	0.562	LNE-2500-3625-1-1
2.500	3.625	0.591	0.591	FNE-2500-3625-1-1
2.500	3.688	0.313	0.688	LSE-2500-3688-1-1
2.500	3.688	0.313	0.688	FSE-2500-3688-1-1
2.500	3.688	0.354	0.630	MLE-2500-3688-B-1
2.500	3.688	0.354	0.709	LWE-2500-3688-1-1
2.500	3.688	0.562	0.562	LNE-2500-3688-1-1
2.500	3.688	0.591	0.591	FNE-2500-3688-1-1
2.500	3.750	0.313	0.688	LSE-2500-3750-1-1
2.500	3.750	0.313	0.688	FSE-2500-3750-1-1
2.500	3.750	0.354	0.630	MLE-2500-3750-B-1
2.500	3.750	0.354	0.709	LWE-2500-3750-1-1
2.500	3.750	0.562	0.562	LNE-2500-3750-1-1
2.500	3.750	0.591	0.591	FNE-2500-3750-1-1
2.500	3.813	0.313	0.688	LSE-2500-3813-1-1
2.500	3.813	0.313	0.688	FSE-2500-3813-1-1
2.500	3.813	0.354	0.630	MLE-2500-3813-B-1
2.500	3.813	0.354	0.709	LWE-2500-3813-1-1
2.500	3.813	0.562	0.562	LNE-2500-3813-1-1
2.500	3.813	0.591	0.591	FNE-2500-3813-1-1
2.500	3.875	0.313	0.688	LSE-2500-3875-1-1
2.500	3.875	0.313	0.688	FSE-2500-3875-1-1
2.500	3.875	0.354	0.630	MLE-2500-3875-B-1
2.500	3.875	0.354	0.709	LWE-2500-3875-1-1



See Section 4 for seal part number prefix description.

03/03/06



Shaft Dia.	Bore Dia.	Total In Bore Depth	Total Seal Width	ProTech Part Number
2.500	3.750	0.562	0.562	LNE-2500-3750-1-1
2.500	3.750	0.591	0.591	FNE-2500-3750-1-1
2.500	3.813	0.313	0.688	LSE-2500-3813-1-1
2.500	3.813	0.313	0.688	FSE-2500-3813-1-1
2.500	3.813	0.354	0.630	MLE-2500-3813-B-1
2.500	3.813	0.354	0.709	LWE-2500-3813-1-1
2.500	3.813	0.562	0.562	LNE-2500-3813-1-1
2.500	3.813	0.591	0.591	FNE-2500-3813-1-1
2.500	3.875	0.313	0.688	LSE-2500-3875-1-1
2.500	3.875	0.313	0.688	FSE-2500-3875-1-1
2.500	3.875	0.354	0.630	MLE-2500-3875-B-1
2.500	3.875	0.354	0.709	LWE-2500-3875-1-1
2.500	3.875	0.562	0.562	LNE-2500-3875-1-1
2.500	3.875	0.591	0.591	FNE-2500-3875-1-1
2.500	3.938	0.313	0.688	LSE-2500-3938-1-1
2.500	3.938	0.313	0.688	FSE-2500-3938-1-1
2.500	3.938	0.354	0.630	MLE-2500-3938-B-1
2.500	3.938	0.354	0.709	LWE-2500-3938-1-1
2.500	3.938	0.562	0.562	LNE-2500-3938-1-1
2.500	3.938	0.591	0.591	FNE-2500-3938-1-1
2.500	4.000	0.313	0.688	LSE-2500-4000-1-1
2.500	4.000	0.313	0.688	FSE-2500-4000-1-1
2.500	4.000	0.354	0.630	MLE-2500-4000-B-1
2.500	4.000	0.354	0.709	LWE-2500-4000-1-1
2.500	4.000	0.562	0.562	LNE-2500-4000-1-1
2.500	4.000	0.591	0.591	FNE-2500-4000-1-1
2.562	3.187	0.313	0.688	LSE-2562-3187-1-1
2.562	3.250	0.313	0.688	LSE-2562-3250-1-1
2.562	3.312	0.313	0.688	LSE-2562-3312-1-1
2.562	3.375	0.313	0.688	LSE-2562-3375-1-1
2.562	3.437	0.313	0.688	LSE-2562-3437-1-1
2.562	3.500	0.313	0.688	LSE-2562-3500-1-1
2.562	3.562	0.313	0.688	LSE-2562-3562-1-1
2.562	3.625	0.313	0.688	LSE-2562-3625-1-1
2.562	3.687	0.313	0.688	LSE-2562-3687-1-1
2.562	3.750	0.313	0.688	LSE-2562-3750-1-1
2.562	3.812	0.313	0.688	LSE-2562-3812-1-1
2.562	3.875	0.313	0.688	LSE-2562-3875-1-1
2.562	3.937	0.313	0.688	LSE-2562-3937-1-1
2.562	4.000	0.313	0.688	LSE-2562-4000-1-1
2.562	4.062	0.313	0.688	LSE-2562-4062-1-1
2.563	3.250	0.354	0.630	MLE-2563-3250-B-1
2.563	3.250	0.354	0.709	LWE-2563-3250-1-1
2.563	3.312	0.313	0.688	FSE-2563-3312-1-1
2.563	3.312	0.562	0.562	LNE-2563-3312-1-1
2.563	3.312	0.591	0.591	FNE-2563-3312-1-1
2.563	3.313	0.354	0.630	MLE-2563-3313-B-1
2.563	3.313	0.354	0.709	LWE-2563-3313-1-1
2.563	3.375	0.313	0.688	FSE-2563-3375-1-1
2.563	3.375	0.354	0.630	MLE-2563-3375-B-1
2.563	3.375	0.354	0.709	LWE-2563-3375-1-1
2.563	3.375	0.562	0.562	LNE-2563-3375-1-1
2.563	3.375	0.591	0.591	FNE-2563-3375-1-1
2.563	3.375	0.591	0.591	FNE-2563-3375-1-1
2.563	3.437	0.313	0.688	FSE-2563-3437-1-1
2.563	3.437	0.562	0.562	LNE-2563-3437-1-1
2.563	3.437	0.591	0.591	FNE-2563-3437-1-1
2.563	3.438	0.354	0.630	MLE-2563-3438-B-1
2.563	3.438	0.354	0.709	LWE-2563-3438-1-1
2.563	3.438	0.562	0.562	LNE-2563-3438-1-1
2.563	3.438	0.591	0.591	FNE-2563-3438-1-1
2.563	3.500	0.313	0.688	LSE-2563-3500-1-1
2.563	3.500	0.354	0.630	MLE-2563-3500-B-1
2.563	3.500	0.354	0.709	LWE-2563-3500-1-1
2.563	3.500	0.562	0.562	LNE-2563-3500-1-1
2.563	3.500	0.591	0.591	FNE-2563-3500-1-1
2.563	3.562	0.313	0.688	FSE-2563-3562-1-1
2.563	3.562	0.562	0.562	LNE-2563-3562-1-1
2.563	3.562	0.591	0.591	FNE-2563-3562-1-1

Shaft Dia.	Bore Dia.	Total In Bore Depth	Total Seal Width	ProTech Part Number
2.563	3.563	0.354	0.630	MLE-2563-3563-B-1
2.563	3.563	0.354	0.709	LWE-2563-3563-1-1
2.563	3.625	0.313	0.688	FSE-2563-3625-1-1
2.563	3.625	0.354	0.630	MLE-2563-3625-B-1
2.563	3.625	0.354	0.709	LWE-2563-3625-1-1
2.563	3.625	0.562	0.562	LNE-2563-3625-1-1
2.563	3.625	0.591	0.591	FNE-2563-3625-1-1
2.563	3.687	0.313	0.688	FSE-2563-3687-1-1
2.563	3.687	0.562	0.562	LNE-2563-3687-1-1
2.563	3.687	0.591	0.591	FNE-2563-3687-1-1
2.563	3.688	0.354	0.630	MLE-2563-3688-B-1
2.563	3.688	0.354	0.709	LWE-2563-3688-1-1
2.563	3.750	0.313	0.688	FSE-2563-3750-1-1
2.563	3.750	0.354	0.630	MLE-2563-3750-B-1
2.563	3.750	0.354	0.709	LWE-2563-3750-1-1
2.563	3.750	0.562	0.562	LNE-2563-3750-1-1
2.563	3.750	0.591	0.591	FNE-2563-3750-1-1
2.563	3.812	0.313	0.688	FSE-2563-3812-1-1
2.563	3.812	0.562	0.562	LNE-2563-3812-1-1
2.563	3.812	0.591	0.591	FNE-2563-3812-1-1
2.563	3.813	0.354	0.630	MLE-2563-3813-B-1
2.563	3.813	0.354	0.709	LWE-2563-3813-1-1
2.563	3.875	0.313	0.688	FSE-2563-3875-1-1
2.563	3.875	0.354	0.630	MLE-2563-3875-B-1
2.563	3.875	0.354	0.709	LWE-2563-3875-1-1
2.563	3.875	0.562	0.562	LNE-2563-3875-1-1
2.563	3.875	0.591	0.591	FNE-2563-3875-1-1
2.563	3.937	0.313	0.688	FSE-2563-3937-1-1
2.563	3.937	0.562	0.562	LNE-2563-3937-1-1
2.563	3.937	0.591	0.591	FNE-2563-3937-1-1
2.563	3.938	0.354	0.630	MLE-2563-3938-B-1
2.563	3.938	0.354	0.709	LWE-2563-3938-1-1
2.563	4.000	0.313	0.688	FSE-2563-4000-1-1
2.563	4.000	0.354	0.630	MLE-2563-4000-B-1
2.563	4.000	0.354	0.709	LWE-2563-4000-1-1
2.563	4.000	0.562	0.562	LNE-2563-4000-1-1
2.563	4.000	0.591	0.591	FNE-2563-4000-1-1
2.563	4.062	0.313	0.688	FSE-2563-4062-1-1
2.563	4.062	0.562	0.562	LNE-2563-4062-1-1
2.563	4.062	0.591	0.591	FNE-2563-4062-1-1
2.563	4.063	0.354	0.630	MLE-2563-4063-B-1
2.563	4.063	0.354	0.709	LWE-2563-4063-1-1
2.625	3.250	0.313	0.688	LSE-2625-3250-1-1
2.625	3.312	0.313	0.688	LSE-2625-3312-1-1
2.625	3.313	0.354	0.630	MLE-2625-3313-B-1
2.625	3.313	0.354	0.709	LWE-2625-3313-1-1
2.625	3.375	0.313	0.688	LSE-2625-3375-1-1
2.625	3.375	0.354	0.630	MLE-2625-3375-B-1
2.625	3.375	0.354	0.709	LWE-2625-3375-1-1
2.625	3.375	0.562	0.562	LNE-2625-3375-1-1
2.625	3.375	0.591	0.591	FNE-2625-3375-1-1
2.625	3.438	0.313	0.688	LSE-2625-3438-1-1
2.625	3.438	0.313	0.688	FSE-2625-3438-1-1
2.625	3.438	0.354	0.630	MLE-2625-3438-B-1
2.625	3.438	0.354	0.709	LWE-2625-3438-1-1
2.625	3.438	0.562	0.562	LNE-2625-3438-1-1
2.625	3.438	0.591	0.591	FNE-2625-3438-1-1
2.625	3.500	0.313	0.688	LSE-2625-3500-1-1
2.625	3.500	0.313	0.688	FSE-2625-3500-1-1
2.625	3.500	0.354	0.630	MLE-2625-3500-B-1
2.625	3.500	0.354	0.630	MLE-2625-3500-B-1
2.625	3.500	0.562	0.562	LNE-2625-3500-1-1
2.625	3.500	0.562	0.562	LNE-2625-3500-1-1
2.625	3.500	0.591	0.591	FNE-2625-3500-1-1
2.625	3.562	0.313	0.688	LSE-2625-3562-1-1
2.625	3.562	0.313	0.688	FSE-2625-3562-1-1

See Section 4 for seal part number prefix description.

03/03/06



2.625 to 2.688

Shaft Dia.	Bore Dia.	Total In Bore Depth	Total Seal Width	ProTech Part Number
2.625	3.562	0.562	0.562	LNE-2625-3562-1-1
2.625	3.562	0.591	0.591	FNE-2625-3562-1-1
2.625	3.563	0.354	0.630	MLE-2625-3563-B-1
2.625	3.563	0.354	0.709	LWE-2625-3563-1-1
2.625	3.625	0.313	0.688	LSE-2625-3625-1-1
2.625	3.625	0.313	0.688	FSE-2625-3625-1-1
2.625	3.625	0.354	0.630	MLE-2625-3625-B-1
2.625	3.625	0.354	0.709	LWE-2625-3625-1-1
2.625	3.625	0.562	0.562	LNE-2625-3625-1-1
2.625	3.625	0.591	0.591	FNE-2625-3625-1-1
2.625	3.688	0.313	0.688	LSE-2625-3688-1-1
2.625	3.688	0.313	0.688	FSE-2625-3688-1-1
2.625	3.688	0.354	0.630	MLE-2625-3688-B-1
2.625	3.688	0.354	0.709	LWE-2625-3688-1-1
2.625	3.688	0.562	0.562	LNE-2625-3688-1-1
2.625	3.688	0.591	0.591	FNE-2625-3688-1-1
2.625	3.750	0.313	0.688	LSE-2625-3750-1-1
2.625	3.750	0.313	0.688	FSE-2625-3750-1-1
2.625	3.750	0.354	0.630	MLE-2625-3750-B-1
2.625	3.750	0.354	0.709	LWE-2625-3750-1-1
2.625	3.750	0.562	0.562	LNE-2625-3750-1-1
2.625	3.750	0.591	0.591	FNE-2625-3750-1-1
2.625	3.813	0.313	0.688	LSE-2625-3813-1-1
2.625	3.813	0.313	0.688	FSE-2625-3813-1-1
2.625	3.813	0.354	0.630	MLE-2625-3813-B-1
2.625	3.813	0.354	0.709	LWE-2625-3813-1-1
2.625	3.813	0.562	0.562	LNE-2625-3813-1-1
2.625	3.813	0.591	0.591	FNE-2625-3813-1-1
2.625	3.875	0.313	0.688	LSE-2625-3875-1-1
2.625	3.875	0.313	0.688	FSE-2625-3875-1-1
2.625	3.875	0.354	0.630	MLE-2625-3875-B-1
2.625	3.875	0.354	0.709	LWE-2625-3875-1-1
2.625	3.875	0.562	0.562	LNE-2625-3875-1-1
2.625	3.875	0.591	0.591	FNE-2625-3875-1-1
2.625	3.938	0.313	0.688	LSE-2625-3938-1-1
2.625	3.938	0.313	0.688	FSE-2625-3938-1-1
2.625	3.938	0.354	0.630	MLE-2625-3938-B-1
2.625	3.938	0.354	0.709	LWE-2625-3938-1-1
2.625	3.938	0.562	0.562	LNE-2625-3938-1-1
2.625	3.938	0.591	0.591	FNE-2625-3938-1-1
2.625	4.000	0.313	0.688	LSE-2625-4000-1-1
2.625	4.000	0.313	0.688	FSE-2625-4000-1-1
2.625	4.000	0.354	0.630	MLE-2625-4000-B-1
2.625	4.000	0.354	0.709	LWE-2625-4000-1-1
2.625	4.000	0.562	0.562	LNE-2625-4000-1-1
2.625	4.000	0.591	0.591	FNE-2625-4000-1-1
2.625	4.062	0.313	0.688	LSE-2625-4062-1-1
2.625	4.062	0.313	0.688	FSE-2625-4062-1-1
2.625	4.062	0.354	0.630	MLE-2625-4062-B-1
2.625	4.062	0.354	0.709	LWE-2625-4062-1-1
2.625	4.062	0.562	0.562	LNE-2625-4062-1-1
2.625	4.062	0.591	0.591	FNE-2625-4062-1-1
2.625	4.063	0.354	0.630	MLE-2625-4063-B-1
2.625	4.063	0.354	0.709	LWE-2625-4063-1-1
2.625	4.125	0.313	0.688	LSE-2625-4125-1-1
2.625	4.125	0.313	0.688	FSE-2625-4125-1-1
2.625	4.125	0.354	0.630	MLE-2625-4125-B-1
2.625	4.125	0.354	0.709	LWE-2625-4125-1-1
2.625	4.125	0.562	0.562	LNE-2625-4125-1-1
2.625	4.125	0.591	0.591	FNE-2625-4125-1-1
2.688	3.313	0.313	0.688	LSE-2688-3313-1-1
2.688	3.375	0.313	0.688	FSE-2688-3375-1-1
2.688	3.375	0.354	0.630	MLE-2688-3375-B-1
2.688	3.375	0.354	0.709	LWE-2688-3375-1-1
2.688	3.438	0.313	0.688	LSE-2688-3438-1-1
2.688	3.438	0.313	0.688	FSE-2688-3438-1-1
2.688	3.438	0.354	0.630	MLE-2688-3438-B-1
2.688	3.438	0.354	0.709	LWE-2688-3438-1-1

Shaft Dia.	Bore Dia.	Total In Bore Depth	Total Seal Width	ProTech Part Number
2.688	3.438	0.562	0.562	LNE-2688-3438-1-1
2.688	3.438	0.591	0.591	FNE-2688-3438-1-1
2.688	3.500	0.313	0.688	LSE-2688-3500-1-1
2.688	3.500	0.313	0.688	FSE-2688-3500-1-1
2.688	3.500	0.354	0.630	MLE-2688-3500-B-1
2.688	3.500	0.354	0.709	LWE-2688-3500-1-1
2.688	3.500	0.562	0.562	LNE-2688-3500-1-1
2.688	3.500	0.591	0.591	FNE-2688-3500-1-1
2.688	3.563	0.313	0.688	LSE-2688-3563-1-1
2.688	3.563	0.313	0.688	FSE-2688-3563-1-1
2.688	3.563	0.354	0.630	MLE-2688-3563-B-1
2.688	3.563	0.354	0.709	LWE-2688-3563-1-1
2.688	3.563	0.562	0.562	LNE-2688-3563-1-1
2.688	3.563	0.591	0.591	FNE-2688-3563-1-1
2.688	3.625	0.313	0.688	LSE-2688-3625-1-1
2.688	3.625	0.313	0.688	FSE-2688-3625-1-1
2.688	3.625	0.354	0.630	MLE-2688-3625-B-1
2.688	3.625	0.354	0.709	LWE-2688-3625-1-1
2.688	3.625	0.562	0.562	LNE-2688-3625-1-1
2.688	3.625	0.591	0.591	FNE-2688-3625-1-1
2.688	3.688	0.313	0.688	LSE-2688-3688-1-1
2.688	3.688	0.313	0.688	FSE-2688-3688-1-1
2.688	3.688	0.354	0.630	MLE-2688-3688-B-1
2.688	3.688	0.354	0.709	LWE-2688-3688-1-1
2.688	3.688	0.562	0.562	LNE-2688-3688-1-1
2.688	3.688	0.591	0.591	FNE-2688-3688-1-1
2.688	3.750	0.313	0.688	LSE-2688-3750-1-1
2.688	3.750	0.313	0.688	FSE-2688-3750-1-1
2.688	3.750	0.354	0.630	MLE-2688-3750-B-1
2.688	3.750	0.354	0.709	LWE-2688-3750-1-1
2.688	3.750	0.562	0.562	LNE-2688-3750-1-1
2.688	3.750	0.591	0.591	FNE-2688-3750-1-1
2.688	3.813	0.313	0.688	LSE-2688-3813-1-1
2.688	3.813	0.313	0.688	FSE-2688-3813-1-1
2.688	3.813	0.354	0.630	MLE-2688-3813-B-1
2.688	3.813	0.354	0.709	LWE-2688-3813-1-1
2.688	3.813	0.562	0.562	LNE-2688-3813-1-1
2.688	3.813	0.591	0.591	FNE-2688-3813-1-1
2.688	3.875	0.313	0.688	LSE-2688-3875-1-1
2.688	3.875	0.313	0.688	FSE-2688-3875-1-1
2.688	3.875	0.354	0.630	MLE-2688-3875-B-1
2.688	3.875	0.354	0.709	LWE-2688-3875-1-1
2.688	3.875	0.562	0.562	LNE-2688-3875-1-1
2.688	3.875	0.591	0.591	FNE-2688-3875-1-1
2.688	3.938	0.313	0.688	LSE-2688-3938-1-1
2.688	3.938	0.313	0.688	FSE-2688-3938-1-1
2.688	3.938	0.354	0.630	MLE-2688-3938-B-1
2.688	3.938	0.354	0.709	LWE-2688-3938-1-1
2.688	3.938	0.562	0.562	LNE-2688-3938-1-1
2.688	3.938	0.591	0.591	FNE-2688-3938-1-1
2.688	4.000	0.313	0.688	LSE-2688-4000-1-1
2.688	4.000	0.313	0.688	FSE-2688-4000-1-1
2.688	4.000	0.354	0.630	MLE-2688-4000-B-1
2.688	4.000	0.354	0.709	LWE-2688-4000-1-1
2.688	4.000	0.562	0.562	LNE-2688-4000-1-1
2.688	4.000	0.591	0.591	FNE-2688-4000-1-1
2.688	4.063	0.313	0.688	LSE-2688-4063-1-1
2.688	4.063	0.313	0.688	FSE-2688-4063-1-1
2.688	4.063	0.354	0.630	MLE-2688-4063-B-1
2.688	4.063	0.354	0.709	LWE-2688-4063-1-1
2.688	4.063	0.562	0.562	LNE-2688-4063-1-1
2.688	4.063	0.591	0.591	FNE-2688-4063-1-1
2.688	4.125	0.313	0.688	LSE-2688-4125-1-1
2.688	4.125	0.313	0.688	FSE-2688-4125-1-1
2.688	4.125	0.354	0.630	MLE-2688-4125-B-1
2.688	4.125	0.354	0.709	LWE-2688-4125-1-1
2.688	4.125	0.562	0.562	LNE-2688-4125-1-1
2.688	4.125	0.591	0.591	FNE-2688-4125-1-1



03/03/06

See **Section 4** for seal part number prefix description.



Shaft Dia.	Bore Dia.	Total In Bore Depth	Total Seal Width	ProTech Part Number
2.688	4.125	0.562	0.562	LNE-2688-4125-1-1
2.688	4.125	0.591	0.591	FNE-2688-4125-1-1
2.688	4.188	0.313	0.688	LSE-2688-4188-1-1
2.688	4.188	0.313	0.688	FSE-2688-4188-1-1
2.688	4.188	0.354	0.630	MLE-2688-4188-B-1
2.688	4.188	0.354	0.709	LWE-2688-4188-1-1
2.688	4.188	0.562	0.562	LNE-2688-4188-1-1
2.688	4.188	0.591	0.591	FNE-2688-4188-1-1
2.750	3.375	0.313	0.688	LSE-2750-3375-1-1
2.750	3.438	0.313	0.688	LSE-2750-3438-1-1
2.750	3.438	0.354	0.630	MLE-2750-3438-B-1
2.750	3.438	0.354	0.709	LWE-2750-3438-1-1
2.750	3.500	0.313	0.688	LSE-2750-3500-1-1
2.750	3.500	0.313	0.688	FSE-2750-3500-1-1
2.750	3.500	0.354	0.630	MLE-2750-3500-B-1
2.750	3.500	0.354	0.709	LWE-2750-3500-1-1
2.750	3.500	0.562	0.562	LNE-2750-3500-1-1
2.750	3.500	0.591	0.591	FNE-2750-3500-1-1
2.750	3.562	0.313	0.688	LSE-2750-3562-1-1
2.750	3.562	0.313	0.688	FSE-2750-3562-1-1
2.750	3.562	0.562	0.562	LNE-2750-3562-1-1
2.750	3.562	0.591	0.591	FNE-2750-3562-1-1
2.750	3.563	0.354	0.630	MLE-2750-3563-B-1
2.750	3.563	0.354	0.709	LWE-2750-3563-1-1
2.750	3.625	0.313	0.688	LSE-2750-3625-1-1
2.750	3.625	0.313	0.688	FSE-2750-3625-1-1
2.750	3.625	0.354	0.630	MLE-2750-3625-B-1
2.750	3.625	0.354	0.709	LWE-2750-3625-1-1
2.750	3.625	0.562	0.562	LNE-2750-3625-1-1
2.750	3.625	0.591	0.591	FNE-2750-3625-1-1
2.750	3.688	0.313	0.688	LSE-2750-3688-1-1
2.750	3.688	0.313	0.688	FSE-2750-3688-1-1
2.750	3.688	0.354	0.630	MLE-2750-3688-B-1
2.750	3.688	0.354	0.709	LWE-2750-3688-1-1
2.750	3.688	0.562	0.562	LNE-2750-3688-1-1
2.750	3.688	0.591	0.591	FNE-2750-3688-1-1
2.750	3.750	0.313	0.688	LSE-2750-3750-1-1
2.750	3.750	0.313	0.688	FSE-2750-3750-1-1
2.750	3.750	0.354	0.630	MLE-2750-3750-B-1
2.750	3.750	0.354	0.709	LWE-2750-3750-1-1
2.750	3.750	0.562	0.562	LNE-2750-3750-1-1
2.750	3.750	0.591	0.591	FNE-2750-3750-1-1
2.750	3.812	0.313	0.688	LSE-2750-3812-1-1
2.750	3.812	0.313	0.688	FSE-2750-3812-1-1
2.750	3.812	0.562	0.562	LNE-2750-3812-1-1
2.750	3.812	0.591	0.591	FNE-2750-3812-1-1
2.750	3.813	0.354	0.630	MLE-2750-3813-B-1
2.750	3.813	0.354	0.709	LWE-2750-3813-1-1
2.750	3.875	0.313	0.688	LSE-2750-3875-1-1
2.750	3.875	0.313	0.688	FSE-2750-3875-1-1
2.750	3.875	0.354	0.630	MLE-2750-3875-B-1
2.750	3.875	0.354	0.709	LWE-2750-3875-1-1
2.750	3.875	0.562	0.562	LNE-2750-3875-1-1
2.750	3.875	0.591	0.591	FNE-2750-3875-1-1
2.750	3.938	0.313	0.688	LSE-2750-3938-1-1
2.750	3.938	0.313	0.688	FSE-2750-3938-1-1
2.750	3.938	0.354	0.630	MLE-2750-3938-B-1
2.750	3.938	0.354	0.709	LWE-2750-3938-1-1
2.750	3.938	0.562	0.562	LNE-2750-3938-1-1
2.750	3.938	0.591	0.591	FNE-2750-3938-1-1
2.750	4.000	0.313	0.688	LSE-2750-4000-1-1
2.750	4.000	0.313	0.688	FSE-2750-4000-1-1
2.750	4.000	0.354	0.630	MLE-2750-4000-B-1
2.750	4.000	0.354	0.709	LWE-2750-4000-1-1
2.750	4.000	0.562	0.562	LNE-2750-4000-1-1
2.750	4.000	0.591	0.591	FNE-2750-4000-1-1

Shaft Dia.	Bore Dia.	Total In Bore Depth	Total Seal Width	ProTech Part Number
2.750	4.062	0.313	0.688	LSE-2750-4062-1-1
2.750	4.062	0.313	0.688	FSE-2750-4062-1-1
2.750	4.062	0.562	0.562	LNE-2750-4062-1-1
2.750	4.062	0.591	0.591	FNE-2750-4062-1-1
2.750	4.063	0.354	0.630	MLE-2750-4063-B-1
2.750	4.063	0.354	0.709	LWE-2750-4063-1-1
2.750	4.125	0.313	0.688	LSE-2750-4125-1-1
2.750	4.125	0.313	0.688	FSE-2750-4125-1-1
2.750	4.125	0.354	0.630	MLE-2750-4125-B-1
2.750	4.125	0.354	0.709	LWE-2750-4125-1-1
2.750	4.125	0.562	0.562	LNE-2750-4125-1-1
2.750	4.125	0.591	0.591	FNE-2750-4125-1-1
2.750	4.188	0.313	0.688	LSE-2750-4188-1-1
2.750	4.188	0.313	0.688	FSE-2750-4188-1-1
2.750	4.188	0.354	0.630	MLE-2750-4188-B-1
2.750	4.188	0.354	0.709	LWE-2750-4188-1-1
2.750	4.188	0.562	0.562	LNE-2750-4188-1-1
2.750	4.188	0.591	0.591	FNE-2750-4188-1-1
2.750	4.250	0.313	0.688	LSE-2750-4250-1-1
2.750	4.250	0.313	0.688	FSE-2750-4250-1-1
2.750	4.250	0.354	0.630	MLE-2750-4250-B-1
2.750	4.250	0.354	0.709	LWE-2750-4250-1-1
2.750	4.250	0.562	0.562	LNE-2750-4250-1-1
2.750	4.250	0.591	0.591	FNE-2750-4250-1-1
2.812	3.437	0.313	0.688	LSE-2812-3437-1-1
2.812	3.500	0.313	0.688	LSE-2812-3500-1-1
2.812	3.562	0.313	0.688	LSE-2812-3562-1-1
2.812	3.625	0.313	0.688	LSE-2812-3625-1-1
2.812	3.687	0.313	0.688	LSE-2812-3687-1-1
2.812	3.750	0.313	0.688	LSE-2812-3750-1-1
2.812	3.812	0.313	0.688	LSE-2812-3812-1-1
2.812	3.875	0.313	0.688	LSE-2812-3875-1-1
2.812	3.937	0.313	0.688	LSE-2812-3937-1-1
2.812	4.000	0.313	0.688	LSE-2812-4000-1-1
2.812	4.062	0.313	0.688	LSE-2812-4062-1-1
2.812	4.125	0.313	0.688	LSE-2812-4125-1-1
2.812	4.187	0.313	0.688	LSE-2812-4187-1-1
2.812	4.250	0.313	0.688	LSE-2812-4250-1-1
2.812	4.312	0.313	0.688	LSE-2812-4312-1-1
2.813	3.500	0.354	0.630	MLE-2813-3500-B-1
2.813	3.500	0.354	0.709	LWE-2813-3500-1-1
2.813	3.562	0.313	0.688	FSE-2813-3562-1-1
2.813	3.562	0.562	0.562	LNE-2813-3562-1-1
2.813	3.562	0.591	0.591	FNE-2813-3562-1-1
2.813	3.563	0.354	0.630	MLE-2813-3563-B-1
2.813	3.563	0.354	0.709	LWE-2813-3563-1-1
2.813	3.625	0.313	0.688	FSE-2813-3625-1-1
2.813	3.625	0.354	0.630	MLE-2813-3625-B-1
2.813	3.625	0.354	0.709	LWE-2813-3625-1-1
2.813	3.625	0.562	0.562	LNE-2813-3625-1-1
2.813	3.625	0.591	0.591	FNE-2813-3625-1-1
2.813	3.687	0.313	0.688	FSE-2813-3687-1-1
2.813	3.687	0.562	0.562	LNE-2813-3687-1-1
2.813	3.687	0.591	0.591	FNE-2813-3687-1-1
2.813	3.688	0.354	0.630	MLE-2813-3688-B-1
2.813	3.688	0.354	0.709	LWE-2813-3688-1-1
2.813	3.750	0.313	0.688	FSE-2813-3750-1-1
2.813	3.750	0.354	0.630	MLE-2813-3750-B-1
2.813	3.750	0.354	0.709	LWE-2813-3750-1-1
2.813	3.750	0.562	0.562	LNE-2813-3750-1-1
2.813	3.750	0.591	0.591	FNE-2813-3750-1-1
2.813	3.812	0.313	0.688	FSE-2813-3812-1-1
2.813	3.812	0.562	0.562	LNE-2813-3812-1-1
2.813	3.812	0.591	0.591	FNE-2813-3812-1-1
2.813	3.813	0.354	0.630	MLE-2813-3813-B-1
2.813	3.813	0.354	0.709	LWE-2813-3813-1-1

F

03/03/06

See Section 4 for seal part number prefix description.



2.813 to 2.938

Shaft Dia.	Bore Dia.	Total In Bore Depth	Total Seal Width	ProTech Part Number
2.813	3.875	0.313	0.688	FSE-2813-3875-1-1
2.813	3.875	0.354	0.630	MLE-2813-3875-B-1
2.813	3.875	0.354	0.709	LWE-2813-3875-1-1
2.813	3.875	0.562	0.562	LNE-2813-3875-1-1
2.813	3.875	0.591	0.591	FNE-2813-3875-1-1
2.813	3.937	0.313	0.688	FSE-2813-3937-1-1
2.813	3.937	0.562	0.562	LNE-2813-3937-1-1
2.813	3.937	0.591	0.591	FNE-2813-3937-1-1
2.813	3.938	0.354	0.630	MLE-2813-3938-B-1
2.813	3.938	0.354	0.709	LWE-2813-3938-1-1
2.813	4.000	0.313	0.688	FSE-2813-4000-1-1
2.813	4.000	0.354	0.630	MLE-2813-4000-B-1
2.813	4.000	0.354	0.709	LWE-2813-4000-1-1
2.813	4.000	0.562	0.562	LNE-2813-4000-1-1
2.813	4.000	0.591	0.591	FNE-2813-4000-1-1
2.813	4.062	0.313	0.688	FSE-2813-4062-1-1
2.813	4.062	0.562	0.562	LNE-2813-4062-1-1
2.813	4.062	0.591	0.591	FNE-2813-4062-1-1
2.813	4.063	0.354	0.630	MLE-2813-4063-B-1
2.813	4.063	0.354	0.709	LWE-2813-4063-1-1
2.813	4.125	0.313	0.688	FSE-2813-4125-1-1
2.813	4.125	0.354	0.630	MLE-2813-4125-B-1
2.813	4.125	0.354	0.709	LWE-2813-4125-1-1
2.813	4.125	0.562	0.562	LNE-2813-4125-1-1
2.813	4.125	0.591	0.591	FNE-2813-4125-1-1
2.813	4.187	0.313	0.688	FSE-2813-4187-1-1
2.813	4.187	0.562	0.562	LNE-2813-4187-1-1
2.813	4.187	0.591	0.591	FNE-2813-4187-1-1
2.813	4.188	0.354	0.630	MLE-2813-4188-B-1
2.813	4.188	0.354	0.709	LWE-2813-4188-1-1
2.813	4.250	0.313	0.688	FSE-2813-4250-1-1
2.813	4.250	0.354	0.630	MLE-2813-4250-B-1
2.813	4.250	0.354	0.709	LWE-2813-4250-1-1
2.813	4.250	0.562	0.562	LNE-2813-4250-1-1
2.813	4.250	0.591	0.591	FNE-2813-4250-1-1
2.813	4.312	0.313	0.688	FSE-2813-4312-1-1
2.813	4.312	0.562	0.562	LNE-2813-4312-1-1
2.813	4.312	0.591	0.591	FNE-2813-4312-1-1
2.813	4.313	0.354	0.630	MLE-2813-4313-B-1
2.813	4.313	0.354	0.709	LWE-2813-4313-1-1
2.875	3.500	0.313	0.688	LSE-2875-3500-1-1
2.875	3.562	0.313	0.688	LSE-2875-3562-1-1
2.875	3.563	0.354	0.630	MLE-2875-3563-B-1
2.875	3.563	0.354	0.709	LWE-2875-3563-1-1
2.875	3.625	0.313	0.688	LSE-2875-3625-1-1
2.875	3.625	0.313	0.688	FSE-2875-3625-1-1
2.875	3.625	0.354	0.630	MLE-2875-3625-B-1
2.875	3.625	0.354	0.709	LWE-2875-3625-1-1
2.875	3.625	0.562	0.562	LNE-2875-3625-1-1
2.875	3.625	0.591	0.591	FNE-2875-3625-1-1
2.875	3.688	0.313	0.688	LSE-2875-3688-1-1
2.875	3.688	0.313	0.688	FSE-2875-3688-1-1
2.875	3.688	0.354	0.630	MLE-2875-3688-B-1
2.875	3.688	0.354	0.709	LWE-2875-3688-1-1
2.875	3.688	0.562	0.562	LNE-2875-3688-1-1
2.875	3.688	0.591	0.591	FNE-2875-3688-1-1
2.875	3.750	0.313	0.688	LSE-2875-3750-1-1
2.875	3.750	0.313	0.688	FSE-2875-3750-1-1
2.875	3.750	0.354	0.630	MLE-2875-3750-B-1
2.875	3.750	0.354	0.709	LWE-2875-3750-1-1
2.875	3.750	0.562	0.562	LNE-2875-3750-1-1
2.875	3.750	0.591	0.591	FNE-2875-3750-1-1
2.875	3.813	0.313	0.688	LSE-2875-3813-1-1
2.875	3.813	0.313	0.688	FSE-2875-3813-1-1
2.875	3.813	0.354	0.630	MLE-2875-3813-B-1
2.875	3.813	0.354	0.709	LWE-2875-3813-1-1

Shaft Dia.	Bore Dia.	Total In Bore Depth	Total Seal Width	ProTech Part Number
2.875	3.813	0.562	0.562	LNE-2875-3813-1-1
2.875	3.813	0.591	0.591	FNE-2875-3813-1-1
2.875	3.875	0.313	0.688	LSE-2875-3875-1-1
2.875	3.875	0.313	0.688	FSE-2875-3875-1-1
2.875	3.875	0.354	0.630	MLE-2875-3875-B-1
2.875	3.875	0.354	0.709	LWE-2875-3875-1-1
2.875	3.875	0.562	0.562	LNE-2875-3875-1-1
2.875	3.875	0.591	0.591	FNE-2875-3875-1-1
2.875	3.938	0.313	0.688	LSE-2875-3938-1-1
2.875	3.938	0.313	0.688	FSE-2875-3938-1-1
2.875	3.938	0.354	0.630	MLE-2875-3938-B-1
2.875	3.938	0.354	0.709	LWE-2875-3938-1-1
2.875	3.938	0.562	0.562	LNE-2875-3938-1-1
2.875	3.938	0.591	0.591	FNE-2875-3938-1-1
2.875	4.000	0.313	0.688	LSE-2875-4000-1-1
2.875	4.000	0.313	0.688	FSE-2875-4000-1-1
2.875	4.000	0.354	0.630	MLE-2875-4000-B-1
2.875	4.000	0.354	0.709	LWE-2875-4000-1-1
2.875	4.000	0.562	0.562	LNE-2875-4000-1-1
2.875	4.000	0.591	0.591	FNE-2875-4000-1-1
2.875	4.062	0.313	0.688	LSE-2875-4062-1-1
2.875	4.062	0.313	0.688	FSE-2875-4062-1-1
2.875	4.062	0.354	0.630	MLE-2875-4062-B-1
2.875	4.062	0.354	0.709	LWE-2875-4062-1-1
2.875	4.062	0.562	0.562	LNE-2875-4062-1-1
2.875	4.062	0.591	0.591	FNE-2875-4062-1-1
2.875	4.063	0.354	0.630	MLE-2875-4063-B-1
2.875	4.063	0.354	0.709	LWE-2875-4063-1-1
2.875	4.125	0.313	0.688	LSE-2875-4125-1-1
2.875	4.125	0.313	0.688	FSE-2875-4125-1-1
2.875	4.125	0.354	0.630	MLE-2875-4125-B-1
2.875	4.125	0.354	0.709	LWE-2875-4125-1-1
2.875	4.125	0.562	0.562	LNE-2875-4125-1-1
2.875	4.125	0.591	0.591	FNE-2875-4125-1-1
2.875	4.187	0.354	0.630	MLE-2875-4187-B-1
2.875	4.187	0.354	0.709	LWE-2875-4187-1-1
2.875	4.187	0.562	0.562	LNE-2875-4187-1-1
2.875	4.187	0.591	0.591	FNE-2875-4187-1-1
2.875	4.188	0.354	0.630	MLE-2875-4188-B-1
2.875	4.188	0.354	0.709	LWE-2875-4188-1-1
2.875	4.188	0.562	0.562	LNE-2875-4188-1-1
2.875	4.188	0.591	0.591	FNE-2875-4188-1-1
2.875	4.250	0.313	0.688	LSE-2875-4188-1-1
2.875	4.250	0.313	0.688	FSE-2875-4188-1-1
2.875	4.250	0.354	0.630	MLE-2875-4188-B-1
2.875	4.250	0.354	0.709	LWE-2875-4188-1-1
2.875	4.250	0.562	0.562	LNE-2875-4188-1-1
2.875	4.250	0.591	0.591	FNE-2875-4188-1-1
2.875	4.312	0.313	0.688	LSE-2875-4188-1-1
2.875	4.312	0.313	0.688	FSE-2875-4188-1-1
2.875	4.312	0.354	0.630	MLE-2875-4188-B-1
2.875	4.312	0.354	0.709	LWE-2875-4188-1-1
2.875	4.312	0.562	0.562	LNE-2875-4188-1-1
2.875	4.312	0.591	0.591	FNE-2875-4188-1-1
2.875	4.313	0.354	0.630	MLE-2875-4250-1-1
2.875	4.313	0.354	0.709	LWE-2875-4250-1-1
2.875	4.313	0.562	0.562	LNE-2875-4250-1-1
2.875	4.313	0.591	0.591	FNE-2875-4250-1-1
2.875	4.312	0.313	0.688	LSE-2875-4250-1-1
2.875	4.312	0.313	0.688	FSE-2875-4250-1-1
2.875	4.312	0.354	0.630	MLE-2875-4250-B-1
2.875	4.312	0.354	0.709	LWE-2875-4250-1-1
2.875	4.312	0.562	0.562	LNE-2875-4250-1-1
2.875	4.312	0.591	0.591	FNE-2875-4250-1-1
2.875	4.375	0.313	0.688	LSE-2875-4250-1-1
2.875	4.375	0.313	0.688	FSE-2875-4250-1-1
2.875	4.375	0.354	0.630	MLE-2875-4250-B-1
2.875	4.375	0.354	0.709	LWE-2875-4250-1-1
2.875	4.375	0.562	0.562	LNE-2875-4250-1-1
2.875	4.375	0.591	0.591	FNE-2875-4250-1-1
2.875	4.312	0.313	0.688	LSE-2875-4312-1-1
2.875	4.312	0.313	0.688	FSE-2875-4312-1-1
2.875	4.312	0.354	0.630	MLE-2875-4312-B-1
2.875	4.312	0.354	0.709	LWE-2875-4312-1-1
2.875	4.312	0.562	0.562	LNE-2875-4312-1-1
2.875	4.312	0.591	0.591	FNE-2875-4312-1-1
2.875	4.313	0.354	0.630	MLE-2875-4313-B-1
2.875	4.313	0.354	0.709	LWE-2875-4313-1-1
2.875	4.375	0.313	0.688	LSE-2875-4375-1-1
2.875	4.375	0.313	0.688	FSE-2875-4375-1-1
2.875	4.375	0.354	0.630	MLE-2875-4375-B-1
2.875	4.375	0.354	0.709	LWE-2875-4375-1-1
2.875	4.375	0.562	0.562	LNE-2875-4375-1-1
2.875	4.375	0.591	0.591	FNE-2875-4375-1-1
2.938	3.563	0.313	0.688	LSE-2938-3563-1-1
2.938	3.625	0.313	0.688	LSE-2938-3625-1-1
2.938	3.625	0.354	0.630	MLE-2938-3625-B-1
2.938	3.625	0.354	0.709	LWE-2938-3625-1-1
2.938	3.688	0.313	0.688	LSE-2938-3688-1-1
2.938	3.688	0.313	0.688	FSE-2938-3688-1-1
2.938	3.688	0.354	0.630	MLE-2938-3688-B-1
2.938	3.688	0.354	0.709	LWE-2938-3688-1-1
2.938	3.688	0.562	0.562	LNE-2938-3688-1-1
2.938	3.688	0.591	0.591	FNE-2938-3688-1-1



03/03/06

See **Section 4** for seal part number prefix description.



Shaft Dia.	Bore Dia.	Total In Bore Depth	Total Seal Width	ProTech Part Number
2.938	3.750	0.313	0.688	LSE-2938-3750-1-1
2.938	3.750	0.313	0.688	FSE-2938-3750-1-1
2.938	3.750	0.354	0.630	MLE-2938-3750-B-1
2.938	3.750	0.354	0.709	LWE-2938-3750-1-1
2.938	3.750	0.562	0.562	LNE-2938-3750-1-1
2.938	3.750	0.591	0.591	FNE-2938-3750-1-1
2.938	3.813	0.313	0.688	LSE-2938-3813-1-1
2.938	3.813	0.313	0.688	FSE-2938-3813-1-1
2.938	3.813	0.354	0.630	MLE-2938-3813-B-1
2.938	3.813	0.354	0.709	LWE-2938-3813-1-1
2.938	3.813	0.562	0.562	LNE-2938-3813-1-1
2.938	3.813	0.591	0.591	FNE-2938-3813-1-1
2.938	3.875	0.313	0.688	LSE-2938-3875-1-1
2.938	3.875	0.313	0.688	FSE-2938-3875-1-1
2.938	3.875	0.354	0.630	MLE-2938-3875-B-1
2.938	3.875	0.354	0.709	LWE-2938-3875-1-1
2.938	3.875	0.562	0.562	LNE-2938-3875-1-1
2.938	3.875	0.591	0.591	FNE-2938-3875-1-1
2.938	3.938	0.313	0.688	LSE-2938-3938-1-1
2.938	3.938	0.313	0.688	FSE-2938-3938-1-1
2.938	3.938	0.354	0.630	MLE-2938-3938-B-1
2.938	3.938	0.354	0.709	LWE-2938-3938-1-1
2.938	3.938	0.562	0.562	LNE-2938-3938-1-1
2.938	3.938	0.591	0.591	FNE-2938-3938-1-1
2.938	4.000	0.313	0.688	LSE-2938-4000-1-1
2.938	4.000	0.313	0.688	FSE-2938-4000-1-1
2.938	4.000	0.354	0.630	MLE-2938-4000-B-1
2.938	4.000	0.354	0.709	LWE-2938-4000-1-1
2.938	4.000	0.562	0.562	LNE-2938-4000-1-1
2.938	4.000	0.591	0.591	FNE-2938-4000-1-1
2.938	4.063	0.313	0.688	LSE-2938-4063-1-1
2.938	4.063	0.313	0.688	FSE-2938-4063-1-1
2.938	4.063	0.354	0.630	MLE-2938-4063-B-1
2.938	4.063	0.354	0.709	LWE-2938-4063-1-1
2.938	4.063	0.562	0.562	LNE-2938-4063-1-1
2.938	4.063	0.591	0.591	FNE-2938-4063-1-1
2.938	4.125	0.313	0.688	LSE-2938-4125-1-1
2.938	4.125	0.313	0.688	FSE-2938-4125-1-1
2.938	4.125	0.354	0.630	MLE-2938-4125-B-1
2.938	4.125	0.354	0.709	LWE-2938-4125-1-1
2.938	4.125	0.562	0.562	LNE-2938-4125-1-1
2.938	4.125	0.591	0.591	FNE-2938-4125-1-1
2.938	4.188	0.313	0.688	LSE-2938-4188-1-1
2.938	4.188	0.313	0.688	FSE-2938-4188-1-1
2.938	4.188	0.354	0.630	MLE-2938-4188-B-1
2.938	4.188	0.354	0.709	LWE-2938-4188-1-1
2.938	4.188	0.562	0.562	LNE-2938-4188-1-1
2.938	4.188	0.591	0.591	FNE-2938-4188-1-1
2.938	4.250	0.313	0.688	LSE-2938-4250-1-1
2.938	4.250	0.313	0.688	FSE-2938-4250-1-1
2.938	4.250	0.354	0.630	MLE-2938-4250-B-1
2.938	4.250	0.354	0.709	LWE-2938-4250-1-1
2.938	4.250	0.562	0.562	LNE-2938-4250-1-1
2.938	4.250	0.591	0.591	FNE-2938-4250-1-1
2.938	4.313	0.313	0.688	LSE-2938-4313-1-1
2.938	4.313	0.313	0.688	FSE-2938-4313-1-1
2.938	4.313	0.354	0.630	MLE-2938-4313-B-1
2.938	4.313	0.354	0.709	LWE-2938-4313-1-1
2.938	4.313	0.562	0.562	LNE-2938-4313-1-1
2.938	4.313	0.591	0.591	FNE-2938-4313-1-1
2.938	4.375	0.313	0.688	LSE-2938-4375-1-1
2.938	4.375	0.313	0.688	FSE-2938-4375-1-1
2.938	4.375	0.354	0.630	MLE-2938-4375-B-1
2.938	4.375	0.354	0.709	LWE-2938-4375-1-1
2.938	4.375	0.562	0.562	LNE-2938-4375-1-1
2.938	4.375	0.591	0.591	FNE-2938-4375-1-1

Shaft Dia.	Bore Dia.	Total In Bore Depth	Total Seal Width	ProTech Part Number
2.938	4.438	0.313	0.688	LSE-2938-4438-1-1
2.938	4.438	0.313	0.688	FSE-2938-4438-1-1
2.938	4.438	0.354	0.630	MLE-2938-4438-B-1
2.938	4.438	0.354	0.709	LWE-2938-4438-1-1
2.938	4.438	0.562	0.562	LNE-2938-4438-1-1
2.938	4.438	0.591	0.591	FNE-2938-4438-1-1
3.000	3.625	0.313	0.688	LSE-3000-3625-1-1
3.000	3.688	0.313	0.688	LSE-3000-3688-1-1
3.000	3.688	0.354	0.630	MLE-3000-3688-B-1
3.000	3.688	0.354	0.709	LWE-3000-3688-1-1
3.000	3.750	0.313	0.688	LSE-3000-3750-1-1
3.000	3.750	0.313	0.688	FSE-3000-3750-1-1
3.000	3.750	0.354	0.630	MLE-3000-3750-B-1
3.000	3.750	0.354	0.709	LWE-3000-3750-1-1
3.000	3.750	0.562	0.562	LNE-3000-3750-1-1
3.000	3.750	0.591	0.591	FNE-3000-3750-1-1
3.000	3.813	0.313	0.688	LSE-3000-3813-1-1
3.000	3.813	0.354	0.630	MLE-3000-3813-B-1
3.000	3.813	0.354	0.709	LWE-3000-3813-1-1
3.000	3.875	0.313	0.688	LSE-3000-3875-1-1
3.000	3.875	0.354	0.630	MLE-3000-3875-B-1
3.000	3.875	0.354	0.709	LWE-3000-3875-1-1
3.000	3.938	0.313	0.688	LSE-3000-3938-1-1
3.000	3.938	0.313	0.688	FSE-3000-3938-1-1
3.000	3.938	0.354	0.630	MLE-3000-3938-B-1
3.000	3.938	0.354	0.709	LWE-3000-3938-1-1
3.000	3.938	0.562	0.562	LNE-3000-3938-1-1
3.000	3.938	0.591	0.591	FNE-3000-3938-1-1
3.000	4.000	0.313	0.688	LSE-3000-4000-1-1
3.000	4.000	0.313	0.688	FSE-3000-4000-1-1
3.000	4.000	0.354	0.630	MLE-3000-4000-B-1
3.000	4.000	0.354	0.709	LWE-3000-4000-1-1
3.000	4.000	0.562	0.562	LNE-3000-4000-1-1
3.000	4.000	0.591	0.591	FNE-3000-4000-1-1
3.000	4.063	0.313	0.688	LSE-3000-4063-1-1
3.000	4.063	0.354	0.630	MLE-3000-4063-B-1
3.000	4.063	0.354	0.709	LWE-3000-4063-1-1
3.000	4.063	0.562	0.562	LNE-3000-4063-1-1
3.000	4.063	0.591	0.591	FNE-3000-4063-1-1
3.000	4.125	0.313	0.688	LSE-3000-4125-1-1
3.000	4.125	0.313	0.688	FSE-3000-4125-1-1
3.000	4.125	0.354	0.630	MLE-3000-4125-B-1
3.000	4.125	0.354	0.709	LWE-3000-4125-1-1
3.000	4.125	0.562	0.562	LNE-3000-4125-1-1
3.000	4.125	0.591	0.591	FNE-3000-4125-1-1
3.000	4.188	0.313	0.688	LSE-3000-4188-1-1
3.000	4.188	0.354	0.630	MLE-3000-4188-B-1
3.000	4.188	0.354	0.709	LWE-3000-4188-1-1
3.000	4.188	0.562	0.562	LNE-3000-4188-1-1
3.000	4.188	0.591	0.591	FNE-3000-4188-1-1
3.000	4.250	0.313	0.688	LSE-3000-4250-1-1
3.000	4.250	0.354	0.630	MLE-3000-4250-B-1
3.000	4.250	0.354	0.709	LWE-3000-4250-1-1
3.000	4.250	0.562	0.562	LNE-3000-4250-1-1
3.000	4.250	0.591	0.591	FNE-3000-4250-1-1
3.000	4.313	0.313	0.688	LSE-3000-4313-1-1
3.000	4.313	0.354	0.630	MLE-3000-4313-B-1
3.000	4.313	0.354	0.709	LWE-3000-4313-1-1
3.000	4.313	0.562	0.562	LNE-3000-4313-1-1
3.000	4.313	0.591	0.591	FNE-3000-4313-1-1
3.000	4.375	0.313	0.688	LSE-3000-4375-1-1
3.000	4.375	0.313	0.688	FSE-3000-4375-1-1
3.000	4.375	0.354	0.630	MLE-3000-4375-B-1
3.000	4.375	0.354	0.709	LWE-3000-4375-1-1
3.000	4.375	0.562	0.562	LNE-3000-4375-1-1
3.000	4.375	0.591	0.591	FSE-3000-4375-1-1

F

See Section 4 for seal part number prefix description.

03/03/06



3.000 to 3.125

Shaft Dia.	Bore Dia.	Total In Bore Depth	Total Seal Width	ProTech Part Number
3.000	4.375	0.354	0.630	MLE-3000-4375-B-1
3.000	4.375	0.354	0.709	LWE-3000-4375-1-1
3.000	4.375	0.562	0.562	LNE-3000-4375-1-1
3.000	4.375	0.591	0.591	FNE-3000-4375-1-1
3.000	4.438	0.313	0.688	LSE-3000-4438-1-1
3.000	4.438	0.313	0.688	FSE-3000-4438-1-1
3.000	4.438	0.354	0.630	MLE-3000-4438-B-1
3.000	4.438	0.354	0.709	LWE-3000-4438-1-1
3.000	4.438	0.562	0.562	LNE-3000-4438-1-1
3.000	4.438	0.591	0.591	FNE-3000-4438-1-1
3.000	4.500	0.313	0.688	LSE-3000-4500-1-1
3.000	4.500	0.313	0.750	FSE-3000-4500-1-1
3.000	4.500	0.354	0.630	MLE-3000-4500-B-1
3.000	4.500	0.354	0.709	LWE-3000-4500-1-1
3.000	4.500	0.562	0.562	LNE-3000-4500-1-1
3.000	4.500	0.591	0.591	FNE-3000-4500-1-1
3.062	3.687	0.375	0.750	LSE-3062-3687-1-1
3.062	3.750	0.375	0.750	LSE-3062-3750-1-1
3.062	3.812	0.375	0.750	LSE-3062-3812-1-1
3.062	3.875	0.375	0.750	LSE-3062-3875-1-1
3.062	3.937	0.375	0.750	LSE-3062-3937-1-1
3.062	4.000	0.375	0.750	LSE-3062-4000-1-1
3.062	4.062	0.375	0.750	LSE-3062-4062-1-1
3.062	4.125	0.375	0.750	LSE-3062-4125-1-1
3.062	4.187	0.375	0.750	LSE-3062-4187-1-1
3.062	4.250	0.375	0.750	LSE-3062-4250-1-1
3.062	4.312	0.375	0.750	LSE-3062-4312-1-1
3.062	4.375	0.375	0.750	LSE-3062-4375-1-1
3.062	4.437	0.375	0.750	LSE-3062-4437-1-1
3.062	4.500	0.375	0.750	LSE-3062-4500-1-1
3.062	4.562	0.375	0.750	LSE-3062-4562-1-1
3.063	3.750	0.354	0.630	MLE-3063-3750-B-1
3.063	3.750	0.354	0.709	LWE-3063-3750-1-1
3.063	3.812	0.375	0.750	FSE-3063-3812-1-1
3.063	3.812	0.562	0.562	LNE-3063-3812-1-1
3.063	3.812	0.591	0.591	FNE-3063-3812-1-1
3.063	3.813	0.354	0.630	MLE-3063-3813-B-1
3.063	3.813	0.354	0.709	LWE-3063-3813-1-1
3.063	3.875	0.354	0.630	MLE-3063-3875-B-1
3.063	3.875	0.354	0.709	LWE-3063-3875-1-1
3.063	3.875	0.375	0.750	FSE-3063-3875-1-1
3.063	3.875	0.562	0.562	LNE-3063-3875-1-1
3.063	3.875	0.591	0.591	FNE-3063-3875-1-1
3.063	3.938	0.354	0.630	MLE-3063-3938-B-1
3.063	3.938	0.354	0.709	LWE-3063-3938-1-1
3.063	3.938	0.375	0.750	FSE-3063-3938-1-1
3.063	3.938	0.562	0.562	LNE-3063-3938-1-1
3.063	3.938	0.591	0.591	FNE-3063-3938-1-1
3.063	4.000	0.354	0.630	MLE-3063-4000-B-1
3.063	4.000	0.354	0.709	LWE-3063-4000-1-1
3.063	4.000	0.375	0.750	FSE-3063-4000-1-1
3.063	4.000	0.562	0.562	LNE-3063-4000-1-1
3.063	4.000	0.591	0.591	FNE-3063-4000-1-1
3.063	4.063	0.354	0.630	MLE-3063-4063-B-1
3.063	4.063	0.354	0.709	LWE-3063-4063-1-1
3.063	4.063	0.375	0.750	FSE-3063-4063-1-1
3.063	4.063	0.562	0.562	LNE-3063-4063-1-1
3.063	4.063	0.591	0.591	FNE-3063-4063-1-1
3.063	4.125	0.354	0.630	MLE-3063-4125-B-1
3.063	4.125	0.354	0.709	LWE-3063-4125-1-1
3.063	4.125	0.375	0.750	FSE-3063-4125-1-1
3.063	4.125	0.562	0.562	LNE-3063-4125-1-1
3.063	4.125	0.591	0.591	FNE-3063-4125-1-1
3.063	4.188	0.354	0.630	MLE-3063-4188-B-1
3.063	4.188	0.354	0.709	LWE-3063-4188-1-1
3.063	4.188	0.375	0.750	FSE-3063-4188-1-1

Shaft Dia.	Bore Dia.	Total In Bore Depth	Total Seal Width	ProTech Part Number
3.063	4.188	0.562	0.562	LNE-3063-4188-1-1
3.063	4.188	0.591	0.591	FNE-3063-4188-1-1
3.063	4.250	0.354	0.630	MLE-3063-4250-B-1
3.063	4.250	0.354	0.709	LWE-3063-4250-1-1
3.063	4.250	0.375	0.750	FSE-3063-4250-1-1
3.063	4.250	0.562	0.562	LNE-3063-4250-1-1
3.063	4.250	0.591	0.591	FNE-3063-4250-1-1
3.063	4.313	0.354	0.630	MLE-3063-4313-B-1
3.063	4.313	0.354	0.709	LWE-3063-4313-1-1
3.063	4.313	0.375	0.750	FSE-3063-4313-1-1
3.063	4.313	0.562	0.562	LNE-3063-4313-1-1
3.063	4.313	0.591	0.591	FNE-3063-4313-1-1
3.063	4.375	0.354	0.630	MLE-3063-4375-B-1
3.063	4.375	0.354	0.709	LWE-3063-4375-1-1
3.063	4.375	0.375	0.750	FSE-3063-4375-1-1
3.063	4.375	0.562	0.562	LNE-3063-4375-1-1
3.063	4.375	0.591	0.591	FNE-3063-4375-1-1
3.063	4.438	0.354	0.630	MLE-3063-4438-B-1
3.063	4.438	0.354	0.709	LWE-3063-4438-1-1
3.063	4.438	0.375	0.750	FSE-3063-4438-1-1
3.063	4.438	0.562	0.562	LNE-3063-4438-1-1
3.063	4.438	0.591	0.591	FNE-3063-4438-1-1
3.063	4.500	0.354	0.630	MLE-3063-4500-B-1
3.063	4.500	0.354	0.709	LWE-3063-4500-1-1
3.063	4.500	0.375	0.750	FSE-3063-4500-1-1
3.063	4.500	0.562	0.562	LNE-3063-4500-1-1
3.063	4.500	0.591	0.591	FNE-3063-4500-1-1
3.063	4.563	0.354	0.630	MLE-3063-4563-B-1
3.063	4.563	0.354	0.709	LWE-3063-4563-1-1
3.063	4.563	0.375	0.750	FSE-3063-4563-1-1
3.063	4.563	0.562	0.562	LNE-3063-4563-1-1
3.063	4.563	0.591	0.591	FNE-3063-4563-1-1
3.125	3.750	0.375	0.750	LSE-3125-3750-1-1
3.125	3.812	0.375	0.750	LSE-3125-3812-1-1
3.125	3.813	0.354	0.630	MLE-3125-3813-B-1
3.125	3.813	0.354	0.709	LWE-3125-3813-1-1
3.125	3.875	0.354	0.630	MLE-3125-3875-B-1
3.125	3.875	0.354	0.709	LWE-3125-3875-1-1
3.125	3.875	0.375	0.750	FSE-3125-3875-1-1
3.125	3.875	0.562	0.562	LNE-3125-3875-1-1
3.125	3.875	0.591	0.591	FNE-3125-3875-1-1
3.125	3.938	0.354	0.630	MLE-3125-3938-B-1
3.125	3.938	0.354	0.709	LWE-3125-3938-1-1
3.125	3.938	0.375	0.750	FSE-3125-3938-1-1
3.125	3.938	0.562	0.562	LNE-3125-3938-1-1
3.125	3.938	0.591	0.591	FNE-3125-3938-1-1
3.125	4.000	0.354	0.630	MLE-3125-4000-B-1
3.125	4.000	0.354	0.709	LWE-3125-4000-1-1
3.125	4.000	0.375	0.750	FSE-3125-4000-1-1
3.125	4.000	0.562	0.562	LNE-3125-4000-1-1
3.125	4.000	0.591	0.591	FNE-3125-4000-1-1
3.125	4.062	0.375	0.750	LSE-3125-4062-1-1
3.125	4.063	0.354	0.630	MLE-3125-4063-B-1
3.125	4.063	0.354	0.709	LWE-3125-4063-1-1
3.125	4.063	0.375	0.750	FSE-3125-4063-1-1
3.125	4.063	0.562	0.562	LNE-3125-4063-1-1
3.125	4.063	0.591	0.591	FNE-3125-4063-1-1
3.125	4.125	0.354	0.630	MLE-3125-4125-B-1
3.125	4.125	0.354	0.709	LWE-3125-4125-1-1
3.125	4.125	0.375	0.750	FSE-3125-4125-1-1
3.125	4.125	0.562	0.562	LNE-3125-4125-1-1
3.125	4.125	0.591	0.591	FNE-3125-4125-1-1



03/03/06

See **Section 4** for seal part number prefix description.



Shaft Dia.	Bore Dia.	Total In Bore Depth	Total Seal Width	ProTech Part Number
3.125	4.188	0.354	0.630	MLE-3125-4188-B-1
3.125	4.188	0.354	0.709	LWE-3125-4188-1-1
3.125	4.188	0.375	0.750	LSE-3125-4188-1-1
3.125	4.188	0.375	0.750	FSE-3125-4188-1-1
3.125	4.188	0.562	0.562	LNE-3125-4188-1-1
3.125	4.188	0.591	0.591	FNE-3125-4188-1-1
3.125	4.250	0.354	0.630	MLE-3125-4250-B-1
3.125	4.250	0.354	0.709	LWE-3125-4250-1-1
3.125	4.250	0.375	0.750	LSE-3125-4250-1-1
3.125	4.250	0.375	0.750	FSE-3125-4250-1-1
3.125	4.250	0.562	0.562	LNE-3125-4250-1-1
3.125	4.250	0.591	0.591	FNE-3125-4250-1-1
3.125	4.312	0.375	0.750	LSE-3125-4312-1-1
3.125	4.313	0.354	0.630	MLE-3125-4313-B-1
3.125	4.313	0.354	0.709	LWE-3125-4313-1-1
3.125	4.313	0.375	0.750	FSE-3125-4313-1-1
3.125	4.313	0.562	0.562	LNE-3125-4313-1-1
3.125	4.313	0.591	0.591	FNE-3125-4313-1-1
3.125	4.375	0.354	0.630	MLE-3125-4375-B-1
3.125	4.375	0.354	0.709	LWE-3125-4375-1-1
3.125	4.375	0.375	0.750	LSE-3125-4375-1-1
3.125	4.375	0.375	0.750	FSE-3125-4375-1-1
3.125	4.375	0.562	0.562	LNE-3125-4375-1-1
3.125	4.375	0.591	0.591	FNE-3125-4375-1-1
3.125	4.438	0.354	0.630	MLE-3125-4438-B-1
3.125	4.438	0.354	0.709	LWE-3125-4438-1-1
3.125	4.438	0.375	0.750	LSE-3125-4438-1-1
3.125	4.438	0.375	0.750	FSE-3125-4438-1-1
3.125	4.438	0.562	0.562	LNE-3125-4438-1-1
3.125	4.438	0.591	0.591	FNE-3125-4438-1-1
3.125	4.500	0.354	0.630	MLE-3125-4500-B-1
3.125	4.500	0.354	0.709	LWE-3125-4500-1-1
3.125	4.500	0.375	0.750	LSE-3125-4500-1-1
3.125	4.500	0.375	0.750	FSE-3125-4500-1-1
3.125	4.500	0.562	0.562	LNE-3125-4500-1-1
3.125	4.500	0.591	0.591	FNE-3125-4500-1-1
3.125	4.563	0.375	0.750	LSE-3125-4562.5-1-1
3.125	4.563	0.354	0.630	MLE-3125-4563-B-1
3.125	4.563	0.354	0.709	LWE-3125-4563-1-1
3.125	4.563	0.375	0.750	FSE-3125-4563-1-1
3.125	4.563	0.591	0.591	FNE-3125-4563-1-1
3.125	4.625	0.354	0.630	MLE-3125-4625-B-1
3.125	4.625	0.354	0.709	LWE-3125-4625-1-1
3.125	4.625	0.375	0.750	LSE-3125-4625-1-1
3.125	4.625	0.375	0.750	FSE-3125-4625-1-1
3.125	4.625	0.562	0.562	LNE-3125-4625-1-1
3.125	4.625	0.591	0.591	FNE-3125-4625-1-1
3.188	3.813	0.375	0.750	LSE-3188-3813-1-1
3.188	3.875	0.375	0.750	LSE-3188-3875-1-1
3.188	3.938	0.375	0.750	LSE-3188-3938-1-1
3.188	3.938	0.375	0.750	FSE-3188-3938-1-1
3.188	3.938	0.562	0.562	LNE-3188-3938-1-1
3.188	3.938	0.591	0.591	FNE-3188-3938-1-1
3.188	4.000	0.375	0.750	LSE-3188-4000-1-1
3.188	4.000	0.375	0.750	FSE-3188-4000-1-1
3.188	4.000	0.562	0.562	LNE-3188-4000-1-1
3.188	4.000	0.591	0.591	FNE-3188-4000-1-1
3.188	4.062	0.375	0.750	FSE-3188-4062-1-1
3.188	4.062	0.562	0.562	LNE-3188-4062-1-1
3.188	4.062	0.591	0.591	FNE-3188-4062-1-1
3.188	4.063	0.354	0.630	MLE-3188-4063-B-1
3.188	4.063	0.354	0.709	LWE-3188-4063-1-1
3.188	4.063	0.375	0.750	LSE-3188-4063-1-1
3.188	4.125	0.354	0.630	MLE-3188-4125-B-1
3.188	4.125	0.354	0.709	LWE-3188-4125-1-1

Shaft Dia.	Bore Dia.	Total In Bore Depth	Total Seal Width	ProTech Part Number
3.188	4.125	0.375	0.750	LSE-3188-4125-1-1
3.188	4.125	0.375	0.750	FSE-3188-4125-1-1
3.188	4.125	0.562	0.562	LNE-3188-4125-1-1
3.188	4.125	0.591	0.591	FNE-3188-4125-1-1
3.188	4.188	0.354	0.630	MLE-3188-4188-B-1
3.188	4.188	0.354	0.709	LWE-3188-4188-1-1
3.188	4.188	0.375	0.750	LSE-3188-4188-1-1
3.188	4.188	0.375	0.750	FSE-3188-4188-1-1
3.188	4.188	0.562	0.562	LNE-3188-4188-1-1
3.188	4.188	0.591	0.591	FNE-3188-4188-1-1
3.188	4.250	0.354	0.630	MLE-3188-4250-B-1
3.188	4.250	0.354	0.709	LWE-3188-4250-1-1
3.188	4.250	0.375	0.750	LSE-3188-4250-1-1
3.188	4.250	0.375	0.750	FSE-3188-4250-1-1
3.188	4.250	0.562	0.562	LNE-3188-4250-1-1
3.188	4.250	0.591	0.591	FNE-3188-4250-1-1
3.188	4.313	0.354	0.630	MLE-3188-4313-B-1
3.188	4.313	0.354	0.709	LWE-3188-4313-1-1
3.188	4.313	0.375	0.750	LSE-3188-4313-1-1
3.188	4.313	0.375	0.750	FSE-3188-4313-1-1
3.188	4.313	0.562	0.562	LNE-3188-4313-1-1
3.188	4.313	0.591	0.591	FNE-3188-4313-1-1
3.188	4.375	0.354	0.630	MLE-3188-4375-B-1
3.188	4.375	0.354	0.709	LWE-3188-4375-1-1
3.188	4.375	0.375	0.750	LSE-3188-4375-1-1
3.188	4.375	0.375	0.750	FSE-3188-4375-1-1
3.188	4.375	0.562	0.562	LNE-3188-4375-1-1
3.188	4.375	0.591	0.591	FNE-3188-4375-1-1
3.188	4.438	0.354	0.630	MLE-3188-4375-B-1
3.188	4.438	0.354	0.709	LWE-3188-4375-1-1
3.188	4.438	0.375	0.750	LSE-3188-4375-1-1
3.188	4.438	0.375	0.750	FSE-3188-4375-1-1
3.188	4.438	0.562	0.562	LNE-3188-4375-1-1
3.188	4.438	0.591	0.591	FNE-3188-4375-1-1
3.188	4.438	0.354	0.630	MLE-3188-4438-B-1
3.188	4.438	0.354	0.709	LWE-3188-4438-1-1
3.188	4.438	0.375	0.750	LSE-3188-4438-1-1
3.188	4.438	0.375	0.750	FSE-3188-4438-1-1
3.188	4.438	0.562	0.562	LNE-3188-4438-1-1
3.188	4.438	0.591	0.591	FNE-3188-4438-1-1
3.188	4.500	0.354	0.630	MLE-3188-4500-B-1
3.188	4.500	0.354	0.709	LWE-3188-4500-1-1
3.188	4.500	0.375	0.750	LSE-3188-4500-1-1
3.188	4.500	0.375	0.750	FSE-3188-4500-1-1
3.188	4.500	0.562	0.562	LNE-3188-4500-1-1
3.188	4.500	0.591	0.591	FNE-3188-4500-1-1
3.188	4.563	0.375	0.750	LSE-3188-4500-1-1
3.188	4.563	0.375	0.750	FSE-3188-4500-1-1
3.188	4.563	0.562	0.562	LNE-3188-4500-1-1
3.188	4.563	0.591	0.591	FNE-3188-4500-1-1
3.188	4.562	0.375	0.750	FSE-3188-4562-1-1
3.188	4.562	0.562	0.562	LNE-3188-4562-1-1
3.188	4.562	0.591	0.591	FNE-3188-4562-1-1
3.188	4.562	0.354	0.630	MLE-3188-4562-B-1
3.188	4.563	0.354	0.709	LWE-3188-4563-1-1
3.188	4.563	0.375	0.750	LSE-3188-4563-1-1
3.188	4.563	0.375	0.750	FSE-3188-4563-1-1
3.188	4.625	0.354	0.630	MLE-3188-4625-B-1
3.188	4.625	0.354	0.709	LWE-3188-4625-1-1
3.188	4.625	0.375	0.750	LSE-3188-4625-1-1
3.188	4.625	0.375	0.750	FSE-3188-4625-1-1
3.188	4.625	0.562	0.562	LNE-3188-4625-1-1
3.188	4.625	0.591	0.591	FNE-3188-4625-1-1
3.188	4.625	0.375	0.750	LSE-3188-4625-1-1
3.188	4.625	0.375	0.750	FSE-3188-4625-1-1
3.188	4.625	0.562	0.562	LNE-3188-4625-1-1
3.188	4.625	0.591	0.591	FNE-3188-4625-1-1
3.188	4.688	0.354	0.630	MLE-3188-4688-B-1
3.188	4.688	0.354	0.709	LWE-3188-4688-1-1
3.188	4.688	0.375	0.750	LSE-3188-4688-1-1
3.188	4.688	0.375	0.750	FSE-3188-4688-1-1
3.188	4.688	0.562	0.562	LNE-3188-4688-1-1
3.188	4.688	0.591	0.591	FNE-3188-4688-1-1
3.250	3.875	0.375	0.750	LSE-3250-3875-1-1
3.250	4.000	0.375	0.750	LSE-3250-3938-1-1
3.250	4.000	0.375	0.750	LSE-3250-4000-1-1
3.250	4.000	0.375	0.750	FSE-3250-4000-1-1
3.250	4.000	0.562	0.562	LNE-3250-4000-1-1
3.250	4.000	0.591	0.591	FNE-3250-4000-1-1
3.250	4.062	0.375	0.750	LSE-3250-4062-1-1
3.250	4.063	0.375	0.750	FSE-3250-4063-1-1

See Section 4 for seal part number prefix description.

03/03/06



3.250 to 3.313

Shaft Dia.	Bore Dia.	Total In Bore Depth	Total Seal Width	ProTech Part Number
3.250	4.063	0.562	0.562	LNE-3250-4063-1-1
3.250	4.063	0.591	0.591	FNE-3250-4063-1-1
3.250	4.125	0.354	0.630	MLE-3250-4125-B-1
3.250	4.125	0.354	0.709	LWE-3250-4125-1-1
3.250	4.125	0.375	0.750	LSE-3250-4125-1-1
3.250	4.125	0.375	0.750	FSE-3250-4125-1-1
3.250	4.125	0.562	0.562	LNE-3250-4125-1-1
3.250	4.125	0.591	0.591	FNE-3250-4125-1-1
3.250	4.188	0.354	0.630	MLE-3250-4188-B-1
3.250	4.188	0.354	0.709	LWE-3250-4188-1-1
3.250	4.188	0.375	0.750	LSE-3250-4188-1-1
3.250	4.188	0.375	0.750	FSE-3250-4188-1-1
3.250	4.188	0.562	0.562	LNE-3250-4188-1-1
3.250	4.188	0.591	0.591	FNE-3250-4188-1-1
3.250	4.250	0.354	0.630	MLE-3250-4250-B-1
3.250	4.250	0.354	0.709	LWE-3250-4250-1-1
3.250	4.250	0.375	0.750	FSE-3250-4250-1-1
3.250	4.250	0.375	0.750	FSE-3250-4250-1-1
3.250	4.250	0.562	0.562	LNE-3250-4250-1-1
3.250	4.250	0.591	0.591	FNE-3250-4250-1-1
3.250	4.312	0.375	0.750	LSE-3250-4312-1-1
3.250	4.313	0.354	0.630	MLE-3250-4313-B-1
3.250	4.313	0.354	0.709	LWE-3250-4313-1-1
3.250	4.313	0.375	0.750	FSE-3250-4313-1-1
3.250	4.313	0.562	0.562	LNE-3250-4313-1-1
3.250	4.313	0.591	0.591	FNE-3250-4313-1-1
3.250	4.375	0.354	0.630	MLE-3250-4375-B-1
3.250	4.375	0.354	0.709	LWE-3250-4375-1-1
3.250	4.375	0.375	0.750	FSE-3250-4375-1-1
3.250	4.375	0.375	0.750	FSE-3250-4375-1-1
3.250	4.375	0.562	0.562	LNE-3250-4375-1-1
3.250	4.375	0.591	0.591	FNE-3250-4375-1-1
3.250	4.437	0.375	0.750	LSE-3250-4437-1-1
3.250	4.438	0.354	0.630	MLE-3250-4438-B-1
3.250	4.438	0.354	0.709	LWE-3250-4438-1-1
3.250	4.438	0.375	0.750	FSE-3250-4438-1-1
3.250	4.438	0.562	0.562	LNE-3250-4438-1-1
3.250	4.438	0.591	0.591	FNE-3250-4438-1-1
3.250	4.500	0.354	0.630	MLE-3250-4500-B-1
3.250	4.500	0.354	0.709	LWE-3250-4500-1-1
3.250	4.500	0.375	0.750	FSE-3250-4500-1-1
3.250	4.500	0.375	0.750	FSE-3250-4500-1-1
3.250	4.500	0.562	0.562	LNE-3250-4500-1-1
3.250	4.500	0.591	0.591	FNE-3250-4500-1-1
3.250	4.562	0.375	0.750	LSE-3250-4562-1-1
3.250	4.563	0.354	0.630	MLE-3250-4563-B-1
3.250	4.563	0.354	0.709	LWE-3250-4563-1-1
3.250	4.563	0.375	0.750	FSE-3250-4563-1-1
3.250	4.563	0.375	0.750	FSE-3250-4563-1-1
3.250	4.563	0.562	0.562	LNE-3250-4563-1-1
3.250	4.563	0.591	0.591	FNE-3250-4563-1-1
3.250	4.625	0.354	0.630	MLE-3250-4625-B-1
3.250	4.625	0.354	0.709	LWE-3250-4625-1-1
3.250	4.625	0.375	0.750	FSE-3250-4625-1-1
3.250	4.625	0.375	0.750	FSE-3250-4625-1-1
3.250	4.625	0.562	0.562	LNE-3250-4625-1-1
3.250	4.625	0.591	0.591	FNE-3250-4625-1-1
3.250	4.688	0.354	0.630	MLE-3250-4688-B-1
3.250	4.688	0.354	0.709	LWE-3250-4688-1-1
3.250	4.688	0.375	0.750	FSE-3250-4688-1-1
3.250	4.688	0.375	0.750	FSE-3250-4688-1-1
3.250	4.688	0.562	0.562	LNE-3250-4688-1-1
3.250	4.688	0.591	0.591	FNE-3250-4688-1-1
3.250	4.750	0.354	0.630	MLE-3250-4750-B-1
3.250	4.750	0.354	0.709	LWE-3250-4750-1-1
3.250	4.750	0.375	0.750	FSE-3250-4750-1-1
3.250	4.750	0.375	0.750	FSE-3250-4750-1-1
3.250	4.750	0.562	0.562	LNE-3250-4750-1-1
3.250	4.750	0.591	0.591	FNE-3250-4750-1-1

Shaft Dia.	Bore Dia.	Total In Bore Depth	Total Seal Width	ProTech Part Number
3.250	4.750	0.562	0.562	LNE-3250-4750-1-1
3.250	4.750	0.591	0.591	FNE-3250-4750-1-1
3.313	3.938	0.375	0.750	LSE-3313-3938-1-1
3.313	4.000	0.375	0.750	LSE-3313-4000-1-1
3.313	4.000	0.375	0.750	FSE-3313-4000-1-1
3.313	4.000	0.562	0.562	LNE-3313-4000-1-1
3.313	4.000	0.591	0.591	FNE-3313-4000-1-1
3.313	4.063	0.375	0.750	LSE-3313-4063-1-1
3.313	4.063	0.375	0.750	FSE-3313-4063-1-1
3.313	4.063	0.562	0.562	LNE-3313-4063-1-1
3.313	4.063	0.591	0.591	FNE-3313-4063-1-1
3.313	4.125	0.375	0.750	LSE-3313-4125-1-1
3.313	4.125	0.375	0.750	FSE-3313-4125-1-1
3.313	4.125	0.562	0.562	LNE-3313-4125-1-1
3.313	4.125	0.591	0.591	FNE-3313-4125-1-1
3.313	4.188	0.354	0.630	MLE-3313-4188-B-1
3.313	4.188	0.354	0.709	LWE-3313-4188-1-1
3.313	4.188	0.375	0.750	LSE-3313-4188-1-1
3.313	4.188	0.375	0.750	FSE-3313-4188-1-1
3.313	4.188	0.562	0.562	LNE-3313-4188-1-1
3.313	4.188	0.591	0.591	FNE-3313-4188-1-1
3.313	4.250	0.354	0.630	MLE-3313-4250-B-1
3.313	4.250	0.354	0.709	LWE-3313-4250-1-1
3.313	4.250	0.375	0.750	LSE-3313-4250-1-1
3.313	4.250	0.375	0.750	FSE-3313-4250-1-1
3.313	4.250	0.562	0.562	LNE-3313-4250-1-1
3.313	4.250	0.591	0.591	FNE-3313-4250-1-1
3.313	4.313	0.354	0.630	MLE-3313-4313-B-1
3.313	4.313	0.354	0.709	LWE-3313-4313-1-1
3.313	4.313	0.375	0.750	LSE-3313-4313-1-1
3.313	4.313	0.375	0.750	FSE-3313-4313-1-1
3.313	4.313	0.562	0.562	LNE-3313-4313-1-1
3.313	4.313	0.591	0.591	FNE-3313-4313-1-1
3.313	4.375	0.354	0.630	MLE-3313-4375-B-1
3.313	4.375	0.354	0.709	LWE-3313-4375-1-1
3.313	4.375	0.375	0.750	LSE-3313-4375-1-1
3.313	4.375	0.375	0.750	FSE-3313-4375-1-1
3.313	4.375	0.562	0.562	LNE-3313-4375-1-1
3.313	4.375	0.591	0.591	FNE-3313-4375-1-1
3.313	4.438	0.354	0.630	MLE-3313-4438-B-1
3.313	4.438	0.354	0.709	LWE-3313-4438-1-1
3.313	4.438	0.375	0.750	LSE-3313-4438-1-1
3.313	4.438	0.375	0.750	FSE-3313-4438-1-1
3.313	4.438	0.562	0.562	LNE-3313-4438-1-1
3.313	4.438	0.591	0.591	FNE-3313-4438-1-1
3.313	4.500	0.354	0.630	MLE-3313-4500-B-1
3.313	4.500	0.354	0.709	LWE-3313-4500-1-1
3.313	4.500	0.375	0.750	LSE-3313-4500-1-1
3.313	4.500	0.375	0.750	FSE-3313-4500-1-1
3.313	4.500	0.562	0.562	LNE-3313-4500-1-1
3.313	4.500	0.591	0.591	FNE-3313-4500-1-1
3.313	4.563	0.354	0.630	MLE-3313-4563-B-1
3.313	4.563	0.354	0.709	LWE-3313-4563-1-1
3.313	4.563	0.375	0.750	LSE-3313-4563-1-1
3.313	4.563	0.375	0.750	FSE-3313-4563-1-1
3.313	4.563	0.562	0.562	LNE-3313-4563-1-1
3.313	4.563	0.591	0.591	FNE-3313-4563-1-1
3.313	4.625	0.354	0.630	MLE-3313-4625-B-1
3.313	4.625	0.354	0.709	LWE-3313-4625-1-1
3.313	4.625	0.375	0.750	LSE-3313-4625-1-1
3.313	4.625	0.375	0.750	FSE-3313-4625-1-1
3.313	4.625	0.562	0.562	LNE-3313-4625-1-1
3.313	4.625	0.591	0.591	FNE-3313-4625-1-1
3.313	4.688	0.354	0.630	MLE-3313-4688-B-1
3.313	4.688	0.354	0.709	LWE-3313-4688-1-1
3.313	4.688	0.375	0.750	LSE-3313-4688-1-1
3.313	4.688	0.375	0.750	FSE-3313-4688-1-1
3.313	4.688	0.562	0.562	LNE-3313-4688-1-1
3.313	4.688	0.591	0.591	FNE-3313-4688-1-1
3.313	4.750	0.354	0.630	MLE-3313-4750-B-1
3.313	4.750	0.354	0.709	LWE-3313-4750-1-1
3.313	4.750	0.375	0.750	LSE-3313-4750-1-1
3.313	4.750	0.375	0.750	FSE-3313-4750-1-1
3.313	4.750	0.562	0.562	LNE-3313-4750-1-1
3.313	4.750	0.591	0.591	FNE-3313-4750-1-1



03/03/06

See **Section 4** for seal part number prefix description.



Shaft Dia.	Bore Dia.	Total In Bore Depth	Total Seal Width	ProTech Part Number
3.313	4.688	0.375	0.750	FSE-3313-4688-1-1
3.313	4.688	0.562	0.562	LNE-3313-4688-1-1
3.313	4.688	0.591	0.591	FNE-3313-4688-1-1
3.313	4.750	0.354	0.630	MLE-3313-4750-B-1
3.313	4.750	0.354	0.709	LWE-3313-4750-1-1
3.313	4.750	0.375	0.750	LSE-3313-4750-1-1
3.313	4.750	0.375	0.750	FSE-3313-4750-1-1
3.313	4.750	0.562	0.562	LNE-3313-4750-1-1
3.313	4.750	0.591	0.591	FNE-3313-4750-1-1
3.313	4.813	0.354	0.630	MLE-3313-4813-B-1
3.313	4.813	0.354	0.709	LWE-3313-4813-1-1
3.313	4.813	0.375	0.750	LSE-3313-4813-1-1
3.313	4.813	0.375	0.750	FSE-3313-4813-1-1
3.313	4.813	0.562	0.562	LNE-3313-4813-1-1
3.313	4.813	0.591	0.591	FNE-3313-4813-1-1
3.375	4.000	0.375	0.750	LSE-3375-4000-1-1
3.375	4.062	0.375	0.750	LSE-3375-4062-1-1
3.375	4.125	0.375	0.750	LSE-3375-4125-1-1
3.375	4.125	0.375	0.750	FSE-3375-4125-1-1
3.375	4.125	0.562	0.562	LNE-3375-4125-1-1
3.375	4.125	0.591	0.591	FNE-3375-4125-1-1
3.375	4.188	0.375	0.750	LSE-3375-4188-1-1
3.375	4.188	0.375	0.750	FSE-3375-4188-1-1
3.375	4.188	0.562	0.562	LNE-3375-4188-1-1
3.375	4.188	0.591	0.591	FNE-3375-4188-1-1
3.375	4.250	0.354	0.630	MLE-3375-4250-B-1
3.375	4.250	0.354	0.709	LWE-3375-4250-1-1
3.375	4.250	0.375	0.750	LSE-3375-4250-1-1
3.375	4.312	0.375	0.750	LSE-3375-4312-1-1
3.375	4.313	0.354	0.630	MLE-3375-4313-B-1
3.375	4.313	0.354	0.709	LWE-3375-4313-1-1
3.375	4.375	0.354	0.630	MLE-3375-4375-B-1
3.375	4.375	0.354	0.709	LWE-3375-4375-1-1
3.375	4.375	0.375	0.750	LSE-3375-4375-1-1
3.375	4.438	0.354	0.630	MLE-3375-4438-B-1
3.375	4.438	0.354	0.709	LWE-3375-4438-1-1
3.375	4.438	0.375	0.750	LSE-3375-4438-1-1
3.375	4.500	0.354	0.630	MLE-3375-4500-B-1
3.375	4.500	0.354	0.709	LWE-3375-4500-1-1
3.375	4.500	0.375	0.750	LSE-3375-4500-1-1
3.375	4.500	0.562	0.562	LNE-3375-4500-1-1
3.375	4.500	0.591	0.591	FNE-3375-4500-1-1
3.375	4.562	0.375	0.750	LSE-3375-4562-1-1
3.375	4.563	0.354	0.630	MLE-3375-4563-B-1
3.375	4.563	0.354	0.709	LWE-3375-4563-1-1
3.375	4.563	0.375	0.750	FSE-3375-4563-1-1
3.375	4.563	0.562	0.562	LNE-3375-4563-1-1
3.375	4.563	0.591	0.591	FNE-3375-4563-1-1
3.375	4.625	0.354	0.630	MLE-3375-4625-B-1
3.375	4.625	0.354	0.709	LWE-3375-4625-1-1
3.375	4.625	0.375	0.750	LSE-3375-4625-1-1
3.375	4.625	0.375	0.750	FSE-3375-4625-1-1
3.375	4.625	0.562	0.562	LNE-3375-4625-1-1
3.375	4.625	0.591	0.591	FNE-3375-4625-1-1
3.375	4.688	0.354	0.630	MLE-3375-4688-B-1
3.375	4.688	0.354	0.709	LWE-3375-4688-1-1
3.375	4.688	0.375	0.750	LSE-3375-4688-1-1
3.375	4.688	0.375	0.750	FSE-3375-4688-1-1
3.375	4.688	0.562	0.562	LNE-3375-4688-1-1
3.375	4.688	0.591	0.591	FNE-3375-4688-1-1
3.375	4.750	0.354	0.630	MLE-3375-4750-B-1
3.375	4.750	0.354	0.709	LWE-3375-4750-1-1
3.375	4.750	0.375	0.750	LSE-3375-4750-1-1
3.375	4.750	0.375	0.750	FSE-3375-4750-1-1
3.375	4.750	0.562	0.562	LNE-3375-4750-1-1

Shaft Dia.	Bore Dia.	Total In Bore Depth	Total Seal Width	ProTech Part Number
3.375	4.750	0.591	0.591	FNE-3375-4750-1-1
3.375	4.812	0.375	0.750	LSE-3375-4812-1-1
3.375	4.813	0.354	0.630	MLE-3375-4813-B-1
3.375	4.813	0.354	0.709	LWE-3375-4813-1-1
3.375	4.813	0.375	0.750	FSE-3375-4813-1-1
3.375	4.813	0.562	0.562	LNE-3375-4813-1-1
3.375	4.813	0.591	0.591	FNE-3375-4813-1-1
3.375	4.875	0.354	0.630	MLE-3375-4875-B-1
3.375	4.875	0.354	0.709	LWE-3375-4875-1-1
3.375	4.875	0.375	0.750	LSE-3375-4875-1-1
3.375	4.875	0.375	0.750	FSE-3375-4875-1-1
3.375	4.875	0.562	0.562	LNE-3375-4875-1-1
3.375	4.875	0.591	0.591	FNE-3375-4875-1-1
3.375	4.875	0.591	0.591	FNE-3375-4875-1-1
3.438	4.063	0.375	0.750	LSE-3438-4063-1-1
3.438	4.125	0.375	0.750	LSE-3438-4125-1-1
3.438	4.188	0.375	0.750	LSE-3438-4188-1-1
3.438	4.188	0.375	0.750	FSE-3438-4188-1-1
3.438	4.188	0.562	0.562	LNE-3438-4188-1-1
3.438	4.188	0.591	0.591	FNE-3438-4188-1-1
3.438	4.250	0.375	0.750	LSE-3438-4250-1-1
3.438	4.250	0.375	0.750	FSE-3438-4250-1-1
3.438	4.250	0.562	0.562	LNE-3438-4250-1-1
3.438	4.250	0.591	0.591	FNE-3438-4250-1-1
3.438	4.313	0.354	0.630	MLE-3438-4313-B-1
3.438	4.313	0.375	0.750	LSE-3438-4313-1-1
3.438	4.313	0.375	0.750	FSE-3438-4313-1-1
3.438	4.313	0.562	0.562	LNE-3438-4313-1-1
3.438	4.313	0.591	0.591	FNE-3438-4313-1-1
3.438	4.375	0.354	0.630	MLE-3438-4375-B-1
3.438	4.375	0.354	0.709	LWE-3438-4375-1-1
3.438	4.375	0.375	0.750	LSE-3438-4375-1-1
3.438	4.375	0.375	0.750	FSE-3438-4375-1-1
3.438	4.375	0.562	0.562	LNE-3438-4375-1-1
3.438	4.375	0.591	0.591	FNE-3438-4375-1-1
3.438	4.438	0.354	0.630	MLE-3438-4438-B-1
3.438	4.438	0.354	0.709	LWE-3438-4438-1-1
3.438	4.438	0.375	0.750	LSE-3438-4438-1-1
3.438	4.438	0.375	0.750	FSE-3438-4438-1-1
3.438	4.438	0.562	0.562	LNE-3438-4438-1-1
3.438	4.438	0.591	0.591	FNE-3438-4438-1-1
3.438	4.500	0.354	0.630	MLE-3438-4500-B-1
3.438	4.500	0.354	0.709	LWE-3438-4500-1-1
3.438	4.500	0.375	0.750	LSE-3438-4500-1-1
3.438	4.500	0.375	0.750	FSE-3438-4500-1-1
3.438	4.500	0.562	0.562	LNE-3438-4500-1-1
3.438	4.500	0.591	0.591	FNE-3438-4500-1-1
3.438	4.563	0.354	0.630	MLE-3438-4563-B-1
3.438	4.563	0.354	0.709	LWE-3438-4563-1-1
3.438	4.563	0.375	0.750	LSE-3438-4563-1-1
3.438	4.563	0.375	0.750	FSE-3438-4563-1-1
3.438	4.563	0.562	0.562	LNE-3438-4563-1-1
3.438	4.563	0.591	0.591	FNE-3438-4563-1-1
3.438	4.625	0.354	0.630	MLE-3438-4625-B-1
3.438	4.625	0.375	0.750	LSE-3438-4625-1-1
3.438	4.625	0.375	0.750	FSE-3438-4625-1-1
3.438	4.625	0.562	0.562	LNE-3438-4625-1-1
3.438	4.625	0.591	0.591	FNE-3438-4625-1-1
3.438	4.625	0.591	0.591	FNE-3438-4625-1-1
3.438	4.688	0.354	0.630	MLE-3438-4688-B-1
3.438	4.688	0.354	0.709	LWE-3438-4688-1-1
3.438	4.688	0.375	0.750	LSE-3438-4688-1-1
3.438	4.688	0.375	0.750	FSE-3438-4688-1-1
3.438	4.688	0.562	0.562	LNE-3438-4688-1-1
3.438	4.688	0.591	0.591	FNE-3438-4688-1-1
3.438	4.688	0.591	0.591	FNE-3438-4688-1-1
3.438	4.750	0.354	0.630	MLE-3438-4750-B-1
3.438	4.750	0.375	0.750	LSE-3438-4750-1-1
3.438	4.750	0.375	0.750	FSE-3438-4750-1-1
3.438	4.750	0.562	0.562	LNE-3438-4750-1-1
3.438	4.750	0.591	0.591	FNE-3438-4750-1-1
3.438	4.750	0.591	0.591	FNE-3438-4750-1-1
3.438	4.750	0.354	0.630	MLE-3438-4750-B-1

See Section 4 for seal part number prefix description.

03/03/06



3.438 to 3.625

Shaft Dia.	Bore Dia.	Total In Bore Depth	Total Seal Width	ProTech Part Number
3.438	4.750	0.354	0.709	LWE-3438-4750-1-1
3.438	4.750	0.375	0.750	LSE-3438-4750-1-1
3.438	4.750	0.375	0.750	FSE-3438-4750-1-1
3.438	4.750	0.562	0.562	LNE-3438-4750-1-1
3.438	4.750	0.591	0.591	FNE-3438-4750-1-1
3.438	4.813	0.354	0.630	MLE-3438-4813-B-1
3.438	4.813	0.354	0.709	LWE-3438-4813-1-1
3.438	4.813	0.375	0.750	LSE-3438-4813-1-1
3.438	4.813	0.375	0.750	FSE-3438-4813-1-1
3.438	4.813	0.562	0.562	LNE-3438-4813-1-1
3.438	4.813	0.591	0.591	FNE-3438-4813-1-1
3.438	4.875	0.354	0.630	MLE-3438-4875-B-1
3.438	4.875	0.354	0.709	LWE-3438-4875-1-1
3.438	4.875	0.375	0.750	LSE-3438-4875-1-1
3.438	4.875	0.375	0.750	FSE-3438-4875-1-1
3.438	4.875	0.562	0.562	LNE-3438-4875-1-1
3.438	4.875	0.591	0.591	FNE-3438-4875-1-1
3.438	4.938	0.354	0.630	MLE-3438-4938-B-1
3.438	4.938	0.354	0.709	LWE-3438-4938-1-1
3.438	4.938	0.375	0.750	LSE-3438-4938-1-1
3.438	4.938	0.375	0.750	FSE-3438-4938-1-1
3.438	4.938	0.562	0.562	LNE-3438-4938-1-1
3.438	4.938	0.591	0.591	FNE-3438-4938-1-1
3.500	4.125	0.375	0.750	LSE-3500-4125-1-1
3.500	4.188	0.375	0.750	LSE-3500-4188-1-1
3.500	4.250	0.375	0.750	LSE-3500-4250-1-1
3.500	4.250	0.375	0.750	FSE-3500-4250-1-1
3.500	4.250	0.562	0.562	LNE-3500-4250-1-1
3.500	4.250	0.591	0.591	FNE-3500-4250-1-1
3.500	4.313	0.375	0.750	LSE-3500-4313-1-1
3.500	4.313	0.375	0.750	FSE-3500-4313-1-1
3.500	4.313	0.562	0.562	LNE-3500-4313-1-1
3.500	4.313	0.591	0.591	FNE-3500-4313-1-1
3.500	4.375	0.354	0.630	MLE-3500-4375-B-1
3.500	4.375	0.354	0.709	LWE-3500-4375-1-1
3.500	4.375	0.375	0.750	LSE-3500-4375-1-1
3.500	4.375	0.375	0.750	FSE-3500-4375-1-1
3.500	4.375	0.562	0.562	LNE-3500-4375-1-1
3.500	4.375	0.591	0.591	FNE-3500-4375-1-1
3.500	4.438	0.354	0.630	MLE-3500-4438-B-1
3.500	4.438	0.354	0.709	LWE-3500-4438-1-1
3.500	4.438	0.375	0.750	LSE-3500-4438-1-1
3.500	4.500	0.354	0.630	MLE-3500-4500-B-1
3.500	4.500	0.354	0.709	LWE-3500-4500-1-1
3.500	4.500	0.375	0.750	LSE-3500-4500-1-1
3.500	4.563	0.354	0.630	MLE-3500-4563-B-1
3.500	4.563	0.354	0.709	LWE-3500-4563-1-1
3.500	4.563	0.375	0.750	LSE-3500-4563-1-1
3.500	4.625	0.354	0.630	MLE-3500-4625-B-1
3.500	4.625	0.354	0.709	LWE-3500-4625-1-1
3.500	4.625	0.375	0.750	LSE-3500-4625-1-1
3.500	4.688	0.354	0.630	MLE-3500-4688-B-1
3.500	4.688	0.354	0.709	LWE-3500-4688-1-1
3.500	4.688	0.375	0.750	LSE-3500-4688-1-1
3.500	4.750	0.354	0.630	MLE-3500-4750-B-1
3.500	4.750	0.354	0.709	LWE-3500-4750-1-1
3.500	4.750	0.375	0.750	LSE-3500-4750-1-1
3.500	4.813	0.354	0.630	MLE-3500-4813-B-1
3.500	4.813	0.354	0.709	LWE-3500-4813-1-1
3.500	4.813	0.375	0.750	LSE-3500-4813-1-1
3.500	4.875	0.354	0.630	MLE-3500-4875-B-1
3.500	4.875	0.354	0.709	LWE-3500-4875-1-1
3.500	4.875	0.375	0.750	LSE-3500-4875-1-1
3.500	4.938	0.354	0.630	MLE-3500-4938-B-1
3.500	4.938	0.354	0.709	LWE-3500-4938-1-1
3.500	4.938	0.375	0.750	LSE-3500-4938-1-1

Shaft Dia.	Bore Dia.	Total In Bore Depth	Total Seal Width	ProTech Part Number
3.500	5.000	0.354	0.630	MLE-3500-5000-B-1
3.500	5.000	0.354	0.709	LWE-3500-5000-1-1
3.500	5.000	0.375	0.750	LSE-3500-5000-1-1
3.562	4.187	0.375	0.750	LSE-3562-4187-1-1
3.562	4.250	0.375	0.750	LSE-3562-4250-1-1
3.562	4.312	0.375	0.750	LSE-3562-4312-1-1
3.562	4.375	0.375	0.750	LSE-3562-4375-1-1
3.562	4.437	0.375	0.750	LSE-3562-4437-1-1
3.562	4.500	0.375	0.750	LSE-3562-4500-1-1
3.562	4.562	0.375	0.750	LSE-3562-4562-1-1
3.562	4.625	0.375	0.750	LSE-3562-4625-1-1
3.562	4.687	0.375	0.750	LSE-3562-4687-1-1
3.562	4.750	0.375	0.750	LSE-3562-4750-1-1
3.562	4.812	0.375	0.750	LSE-3562-4812-1-1
3.562	4.875	0.375	0.750	LSE-3562-4875-1-1
3.562	4.937	0.375	0.750	LSE-3562-4937-1-1
3.562	5.000	0.375	0.750	LSE-3562-5000-1-1
3.562	5.062	0.375	0.750	LSE-3562-5062-1-1
3.563	4.438	0.354	0.630	MLE-3563-4438-B-1
3.563	4.438	0.354	0.709	LWE-3563-4438-1-1
3.563	4.500	0.354	0.630	MLE-3563-4500-B-1
3.563	4.500	0.354	0.709	LWE-3563-4500-1-1
3.563	4.563	0.354	0.630	MLE-3563-4563-B-1
3.563	4.563	0.354	0.709	LWE-3563-4563-1-1
3.563	4.625	0.354	0.630	MLE-3563-4625-B-1
3.563	4.625	0.354	0.709	LWE-3563-4625-1-1
3.563	4.688	0.354	0.630	MLE-3563-4688-B-1
3.563	4.688	0.354	0.709	LWE-3563-4688-1-1
3.563	4.750	0.354	0.630	MLE-3563-4750-B-1
3.563	4.750	0.354	0.709	LWE-3563-4750-1-1
3.563	4.813	0.354	0.630	MLE-3563-4813-B-1
3.563	4.813	0.354	0.709	LWE-3563-4813-1-1
3.563	4.875	0.354	0.630	MLE-3563-4875-B-1
3.563	4.875	0.354	0.709	LWE-3563-4875-1-1
3.563	4.938	0.354	0.630	MLE-3563-4938-B-1
3.563	4.938	0.354	0.709	LWE-3563-4938-1-1
3.563	5.000	0.354	0.630	MLE-3563-5000-B-1
3.563	5.000	0.354	0.709	LWE-3563-5000-1-1
3.563	5.063	0.354	0.630	MLE-3563-5063-B-1
3.563	5.063	0.354	0.709	LWE-3563-5063-1-1
3.625	4.250	0.375	0.750	LSE-3625-4250-1-1
3.625	4.312	0.375	0.750	LSE-3625-4312-1-1
3.625	4.375	0.375	0.750	LSE-3625-4375-1-1
3.625	4.438	0.375	0.750	LSE-3625-4438-1-1
3.625	4.500	0.354	0.630	MLE-3625-4500-B-1
3.625	4.500	0.354	0.709	LWE-3625-4500-1-1
3.625	4.500	0.375	0.750	LSE-3625-4500-1-1
3.625	4.562	0.375	0.750	LSE-3625-4562-1-1
3.625	4.563	0.354	0.630	MLE-3625-4563-B-1
3.625	4.563	0.354	0.709	LWE-3625-4563-1-1
3.625	4.625	0.354	0.630	MLE-3625-4625-B-1
3.625	4.625	0.354	0.709	LWE-3625-4625-1-1
3.625	4.625	0.375	0.750	LSE-3625-4625-1-1
3.625	4.688	0.354	0.630	MLE-3625-4688-B-1
3.625	4.688	0.354	0.709	LWE-3625-4688-1-1
3.625	4.688	0.375	0.750	LSE-3625-4688-1-1
3.625	4.750	0.354	0.630	MLE-3625-4750-B-1
3.625	4.750	0.354	0.709	LWE-3625-4750-1-1
3.625	4.750	0.375	0.750	LSE-3625-4750-1-1
3.625	4.813	0.354	0.630	MLE-3625-4813-B-1
3.625	4.813	0.354	0.709	LWE-3625-4813-1-1
3.625	4.813	0.375	0.750	LSE-3625-4813-1-1
3.625	4.875	0.354	0.630	MLE-3625-4875-B-1
3.625	4.875	0.354	0.709	LWE-3625-4875-1-1
3.625	4.875	0.375	0.750	LSE-3625-4875-1-1
3.625	4.938	0.354	0.630	MLE-3625-4938-B-1
3.625	4.938	0.354	0.709	LWE-3625-4938-1-1
3.625	4.938	0.375	0.750	LSE-3625-4938-1-1



03/03/06

See **Section 4** for seal part number prefix description.



F-31

Parker Hannifin Corporation

EPS Division

Toll Free: (800) 233-3900

www.parkerseals.com

Shaft Dia.	Bore Dia.	Total In Bore Depth	Total Seal Width	ProTech Part Number
3.625	4.938	0.354	0.709	LWE-3625-4938-1-1
3.625	4.938	0.375	0.750	LSE-3625-4938-1-1
3.625	5.000	0.354	0.630	MLE-3625-5000-B-1
3.625	5.000	0.354	0.709	LWE-3625-5000-1-1
3.625	5.000	0.375	0.750	LSE-3625-5000-1-1
3.625	5.062	0.375	0.750	LSE-3625-5062-1-1
3.625	5.062	0.375	0.750	FSE-3625-5062-1-1
3.625	5.062	0.562	0.562	LNE-3625-5062-1-1
3.625	5.062	0.591	0.591	FNE-3625-5062-1-1
3.625	5.063	0.354	0.630	MLE-3625-5063-B-1
3.625	5.063	0.354	0.709	LWE-3625-5063-1-1
3.625	5.125	0.354	0.630	MLE-3625-5125-B-1
3.625	5.125	0.354	0.709	LWE-3625-5125-1-1
3.625	5.125	0.375	0.750	LSE-3625-5125-1-1
3.625	5.125	0.375	0.750	FSE-3625-5125-1-1
3.625	5.125	0.562	0.562	LNE-3625-5125-1-1
3.625	5.125	0.591	0.591	FNE-3625-5125-1-1
3.688	4.313	0.375	0.750	LSE-3688-4313-1-1
3.688	4.375	0.375	0.750	LSE-3688-4375-1-1
3.688	4.438	0.375	0.750	LSE-3688-4438-1-1
3.688	4.438	0.375	0.750	FSE-3688-4438-1-1
3.688	4.438	0.562	0.562	LNE-3688-4438-1-1
3.688	4.438	0.591	0.591	FNE-3688-4438-1-1
3.688	4.500	0.375	0.750	LSE-3688-4500-1-1
3.688	4.500	0.375	0.750	FSE-3688-4500-1-1
3.688	4.500	0.562	0.562	LNE-3688-4500-1-1
3.688	4.500	0.591	0.591	FNE-3688-4500-1-1
3.688	4.563	0.354	0.630	MLE-3688-4563-B-1
3.688	4.563	0.354	0.709	LWE-3688-4563-1-1
3.688	4.563	0.375	0.750	LSE-3688-4563-1-1
3.688	4.563	0.375	0.750	FSE-3688-4563-1-1
3.688	4.563	0.562	0.562	LNE-3688-4563-1-1
3.688	4.563	0.591	0.591	FNE-3688-4563-1-1
3.688	4.625	0.375	0.750	LSE-3688-4625-1-1
3.688	4.625	0.375	0.750	FSE-3688-4625-1-1
3.688	4.625	0.562	0.562	LNE-3688-4625-1-1
3.688	4.625	0.591	0.591	FNE-3688-4625-1-1
3.688	4.688	0.354	0.630	MLE-3688-4688-B-1
3.688	4.688	0.354	0.709	LWE-3688-4688-1-1
3.688	4.688	0.375	0.750	LSE-3688-4688-1-1
3.688	4.688	0.375	0.750	FSE-3688-4688-1-1
3.688	4.688	0.562	0.562	LNE-3688-4688-1-1
3.688	4.688	0.591	0.591	FNE-3688-4688-1-1
3.688	4.688	0.591	0.591	FNE-3688-4688-1-1
3.688	4.750	0.375	0.750	LSE-3688-4750-1-1
3.688	4.750	0.375	0.750	FSE-3688-4750-1-1
3.688	4.750	0.562	0.562	LNE-3688-4750-1-1
3.688	4.750	0.591	0.591	FNE-3688-4750-1-1
3.688	4.813	0.375	0.750	LSE-3688-4813-1-1
3.688	4.813	0.375	0.750	FSE-3688-4813-1-1
3.688	4.813	0.562	0.562	LNE-3688-4813-1-1
3.688	4.813	0.591	0.591	FNE-3688-4813-1-1
3.688	4.813	0.591	0.591	FNE-3688-4813-1-1
3.688	4.875	0.375	0.750	LSE-3688-4875-1-1
3.688	4.875	0.375	0.750	FSE-3688-4875-1-1
3.688	4.875	0.562	0.562	LNE-3688-4875-1-1
3.688	4.875	0.591	0.591	FNE-3688-4875-1-1
3.688	4.875	0.591	0.591	FNE-3688-4875-1-1
3.688	4.938	0.375	0.750	LSE-3688-4938-1-1
3.688	4.938	0.375	0.750	FSE-3688-4938-1-1
3.688	4.938	0.562	0.562	LNE-3688-4938-1-1
3.688	4.938	0.591	0.591	FNE-3688-4938-1-1
3.688	5.000	0.375	0.750	LSE-3688-5000-1-1
3.688	5.000	0.375	0.750	FSE-3688-5000-1-1
3.688	5.000	0.562	0.562	LNE-3688-5000-1-1
3.688	5.000	0.591	0.591	FNE-3688-5000-1-1
3.688	5.000	0.562	0.562	LNE-3688-5000-1-1
3.688	5.000	0.591	0.591	FNE-3688-5000-1-1
3.688	5.063	0.375	0.750	LSE-3688-5063-1-1
3.688	5.063	0.375	0.750	FSE-3688-5063-1-1
3.688	5.063	0.562	0.562	LNE-3688-5063-1-1

Shaft Dia.	Bore Dia.	Total In Bore Depth	Total Seal Width	ProTech Part Number
3.688	5.063	0.591	0.591	FNE-3688-5063-1-1
3.688	5.125	0.375	0.750	LSE-3688-5125-1-1
3.688	5.125	0.375	0.750	FSE-3688-5125-1-1
3.688	5.125	0.562	0.562	LNE-3688-5125-1-1
3.688	5.125	0.591	0.591	FNE-3688-5125-1-1
3.688	5.188	0.375	0.750	LSE-3688-5188-1-1
3.688	5.188	0.375	0.750	FSE-3688-5188-1-1
3.688	5.188	0.562	0.562	LNE-3688-5188-1-1
3.688	5.188	0.591	0.591	FNE-3688-5188-1-1
3.750	4.375	0.375	0.750	LSE-3750-4375-1-1
3.750	4.438	0.375	0.750	LSE-3750-4438-1-1
3.750	4.500	0.375	0.750	LSE-3750-4500-1-1
3.750	4.500	0.375	0.750	FSE-3750-4500-1-1
3.750	4.500	0.562	0.562	LNE-3750-4500-1-1
3.750	4.500	0.591	0.591	FNE-3750-4500-1-1
3.750	4.562	0.375	0.750	LSE-3750-4562-1-1
3.750	4.562	0.375	0.750	FSE-3750-4562-1-1
3.750	4.562	0.562	0.562	LNE-3750-4562-1-1
3.750	4.562	0.591	0.591	FNE-3750-4562-1-1
3.750	4.625	0.354	0.630	MLE-3750-4625-B-1
3.750	4.625	0.354	0.709	LWE-3750-4625-1-1
3.750	4.625	0.375	0.750	LSE-3750-4625-1-1
3.750	4.625	0.375	0.750	FSE-3750-4625-1-1
3.750	4.625	0.562	0.562	LNE-3750-4625-1-1
3.750	4.625	0.591	0.591	FNE-3750-4625-1-1
3.750	4.688	0.354	0.630	MLE-3750-4688-B-1
3.750	4.688	0.354	0.709	LWE-3750-4688-1-1
3.750	4.688	0.375	0.750	LSE-3750-4688-1-1
3.750	4.688	0.375	0.750	FSE-3750-4688-1-1
3.750	4.688	0.562	0.562	LNE-3750-4688-1-1
3.750	4.688	0.591	0.591	FNE-3750-4688-1-1
3.750	4.750	0.354	0.630	MLE-3750-4750-B-1
3.750	4.750	0.354	0.709	LWE-3750-4750-1-1
3.750	4.750	0.375	0.750	LSE-3750-4750-1-1
3.750	4.750	0.375	0.750	FSE-3750-4750-1-1
3.750	4.750	0.562	0.562	LNE-3750-4750-1-1
3.750	4.750	0.591	0.591	FNE-3750-4750-1-1
3.750	4.812	0.375	0.750	LSE-3750-4812-1-1
3.750	4.812	0.375	0.750	FSE-3750-4812-1-1
3.750	4.812	0.562	0.562	LNE-3750-4812-1-1
3.750	4.812	0.591	0.591	FNE-3750-4812-1-1
3.750	4.813	0.354	0.630	MLE-3750-4813-B-1
3.750	4.813	0.354	0.709	LWE-3750-4813-1-1
3.750	4.875	0.354	0.630	MLE-3750-4875-B-1
3.750	4.875	0.354	0.709	LWE-3750-4875-1-1
3.750	4.875	0.375	0.750	LSE-3750-4875-1-1
3.750	4.875	0.375	0.750	FSE-3750-4875-1-1
3.750	4.875	0.562	0.562	LNE-3750-4875-1-1
3.750	4.875	0.591	0.591	FNE-3750-4875-1-1
3.750	4.938	0.354	0.630	MLE-3750-4938-B-1
3.750	4.938	0.354	0.709	LWE-3750-4938-1-1
3.750	4.938	0.375	0.750	LSE-3750-4938-1-1
3.750	4.938	0.375	0.750	FSE-3750-4938-1-1
3.750	4.938	0.562	0.562	LNE-3750-4938-1-1
3.750	4.938	0.591	0.591	FNE-3750-4938-1-1
3.750	5.000	0.354	0.630	MLE-3750-5000-B-1
3.750	5.000	0.354	0.709	LWE-3750-5000-1-1
3.750	5.000	0.375	0.750	LSE-3750-5000-1-1
3.750	5.000	0.375	0.750	FSE-3750-5000-1-1
3.750	5.000	0.562	0.562	LNE-3750-5000-1-1
3.750	5.000	0.591	0.591	FNE-3750-5000-1-1
3.750	5.062	0.375	0.750	LSE-3750-5062-1-1
3.750	5.062	0.375	0.750	FSE-3750-5062-1-1
3.750	5.062	0.562	0.562	LNE-3750-5062-1-1
3.750	5.062	0.591	0.591	FNE-3750-5062-1-1
3.750	5.063	0.354	0.630	MLE-3750-5063-B-1

See Section 4 for seal part number prefix description.

03/03/06



3.750 to 3.875

Shaft Dia.	Bore Dia.	Total In Bore Depth	Total Seal Width	ProTech Part Number
3.750	5.063	0.354	0.709	LWE-3750-5063-1-1
3.750	5.125	0.354	0.630	MLE-3750-5125-B-1
3.750	5.125	0.354	0.709	LWE-3750-5125-1-1
3.750	5.125	0.375	0.750	LSE-3750-5125-1-1
3.750	5.125	0.375	0.750	FSE-3750-5125-1-1
3.750	5.125	0.562	0.562	LNE-3750-5125-1-1
3.750	5.125	0.591	0.591	FNE-3750-5125-1-1
3.750	5.188	0.354	0.630	MLE-3750-5188-B-1
3.750	5.188	0.354	0.709	LWE-3750-5188-1-1
3.750	5.188	0.375	0.750	LSE-3750-5188-1-1
3.750	5.188	0.375	0.750	FSE-3750-5188-1-1
3.750	5.188	0.562	0.562	LNE-3750-5188-1-1
3.750	5.188	0.591	0.591	FNE-3750-5188-1-1
3.750	5.250	0.354	0.630	MLE-3750-5250-B-1
3.750	5.250	0.354	0.709	LWE-3750-5250-1-1
3.750	5.250	0.375	0.750	LSE-3750-5250-1-1
3.750	5.250	0.375	0.750	FSE-3750-5250-1-1
3.750	5.250	0.562	0.562	LNE-3750-5250-1-1
3.750	5.250	0.591	0.591	FNE-3750-5250-1-1
3.812	4.437	0.375	0.750	LSE-3812-4437-1-1
3.812	4.500	0.375	0.750	LSE-3812-4500-1-1
3.812	4.562	0.375	0.750	LSE-3812-4562-1-1
3.812	4.625	0.375	0.750	LSE-3812-4625-1-1
3.812	4.687	0.375	0.750	LSE-3812-4687-1-1
3.812	4.750	0.375	0.750	LSE-3812-4750-1-1
3.812	4.812	0.375	0.750	LSE-3812-4812-1-1
3.812	4.875	0.375	0.750	LSE-3812-4875-1-1
3.812	4.937	0.375	0.750	LSE-3812-4937-1-1
3.812	5.000	0.375	0.750	LSE-3812-5000-1-1
3.812	5.062	0.375	0.750	LSE-3812-5062-1-1
3.812	5.125	0.375	0.750	LSE-3812-5125-1-1
3.812	5.187	0.375	0.750	LSE-3812-5187-1-1
3.812	5.250	0.375	0.750	LSE-3812-5250-1-1
3.812	5.312	0.375	0.750	LSE-3812-5312-1-1
3.813	4.562	0.375	0.750	FSE-3813-4562-1-1
3.813	4.562	0.562	0.562	LNE-3813-4562-1-1
3.813	4.562	0.591	0.591	FNE-3813-4562-1-1
3.813	4.625	0.375	0.750	FSE-3813-4625-1-1
3.813	4.625	0.562	0.562	LNE-3813-4625-1-1
3.813	4.625	0.591	0.591	FNE-3813-4625-1-1
3.813	4.687	0.375	0.750	FSE-3813-4687-1-1
3.813	4.687	0.562	0.562	LNE-3813-4687-1-1
3.813	4.687	0.591	0.591	FNE-3813-4687-1-1
3.813	4.688	0.354	0.630	MLE-3813-4688-B-1
3.813	4.688	0.354	0.709	LWE-3813-4688-1-1
3.813	4.750	0.354	0.630	MLE-3813-4750-B-1
3.813	4.750	0.354	0.709	LWE-3813-4750-1-1
3.813	4.812	0.375	0.750	FSE-3813-4812-1-1
3.813	4.812	0.562	0.562	LNE-3813-4812-1-1
3.813	4.812	0.591	0.591	FNE-3813-4812-1-1
3.813	4.813	0.354	0.630	MLE-3813-4813-B-1
3.813	4.813	0.354	0.709	LWE-3813-4813-1-1
3.813	4.875	0.354	0.630	MLE-3813-4875-B-1
3.813	4.875	0.354	0.709	LWE-3813-4875-1-1
3.813	4.875	0.375	0.750	FSE-3813-4875-1-1
3.813	4.875	0.562	0.562	LNE-3813-4875-1-1
3.813	4.875	0.591	0.591	FNE-3813-4875-1-1
3.813	4.937	0.375	0.750	FSE-3813-4937-1-1
3.813	4.937	0.562	0.562	LNE-3813-4937-1-1
3.813	4.937	0.591	0.591	FNE-3813-4937-1-1
3.813	4.938	0.354	0.630	MLE-3813-4938-B-1
3.813	4.938	0.354	0.709	LWE-3813-4938-1-1
3.813	5.000	0.354	0.630	MLE-3813-5000-B-1
3.813	5.000	0.354	0.709	LWE-3813-5000-1-1
3.813	5.000	0.375	0.750	FSE-3813-5000-1-1
3.813	5.000	0.562	0.562	LNE-3813-5000-1-1

Shaft Dia.	Bore Dia.	Total In Bore Depth	Total Seal Width	ProTech Part Number
3.813	5.000	0.591	0.591	FNE-3813-5000-1-1
3.813	5.062	0.375	0.750	FSE-3813-5062-1-1
3.813	5.062	0.562	0.562	LNE-3813-5062-1-1
3.813	5.062	0.591	0.591	FNE-3813-5062-1-1
3.813	5.063	0.354	0.630	MLE-3813-5063-B-1
3.813	5.063	0.354	0.709	LWE-3813-5063-1-1
3.813	5.125	0.354	0.630	MLE-3813-5125-B-1
3.813	5.125	0.354	0.709	LWE-3813-5125-1-1
3.813	5.125	0.375	0.750	FSE-3813-5125-1-1
3.813	5.125	0.562	0.562	LNE-3813-5125-1-1
3.813	5.125	0.591	0.591	FNE-3813-5125-1-1
3.813	5.187	0.375	0.750	FSE-3813-5187-1-1
3.813	5.187	0.562	0.562	LNE-3813-5187-1-1
3.813	5.187	0.591	0.591	FNE-3813-5187-1-1
3.813	5.188	0.354	0.630	MLE-3813-5188-B-1
3.813	5.188	0.354	0.709	LWE-3813-5188-1-1
3.813	5.250	0.354	0.630	MLE-3813-5250-B-1
3.813	5.250	0.354	0.709	LWE-3813-5250-1-1
3.813	5.250	0.375	0.750	FSE-3813-5250-1-1
3.813	5.250	0.562	0.562	LNE-3813-5250-1-1
3.813	5.250	0.591	0.591	FNE-3813-5250-1-1
3.813	5.312	0.375	0.750	FSE-3813-5312-1-1
3.813	5.312	0.562	0.562	LNE-3813-5312-1-1
3.813	5.312	0.591	0.591	FNE-3813-5312-1-1
3.813	5.313	0.354	0.630	MLE-3813-5313-B-1
3.813	5.313	0.354	0.709	LWE-3813-5313-1-1
3.813	5.562	0.375	0.750	FSE-3813-5562-1-1
3.813	5.562	0.562	0.562	LNE-3813-5562-1-1
3.813	5.562	0.591	0.591	FNE-3813-5562-1-1
3.813	5.625	0.375	0.750	FSE-3813-5625-1-1
3.813	5.625	0.562	0.562	LNE-3813-5625-1-1
3.813	5.625	0.591	0.591	FNE-3813-5625-1-1
3.875	4.500	0.375	0.750	LSE-3875-4500-1-1
3.875	4.562	0.375	0.750	LSE-3875-4562-1-1
3.875	4.625	0.375	0.750	LSE-3875-4625-1-1
3.875	4.625	0.375	0.750	FSE-3875-4625-1-1
3.875	4.625	0.562	0.562	LNE-3875-4625-1-1
3.875	4.625	0.591	0.591	FNE-3875-4625-1-1
3.875	4.688	0.375	0.750	LSE-3875-4688-1-1
3.875	4.688	0.562	0.562	LNE-3875-4688-1-1
3.875	4.688	0.591	0.591	FNE-3875-4688-1-1
3.875	4.750	0.354	0.630	MLE-3875-4750-B-1
3.875	4.750	0.354	0.709	LWE-3875-4750-1-1
3.875	4.750	0.375	0.750	LSE-3875-4750-1-1
3.875	4.750	0.375	0.750	FSE-3875-4750-1-1
3.875	4.750	0.562	0.562	LNE-3875-4750-1-1
3.875	4.750	0.591	0.591	FNE-3875-4750-1-1
3.875	4.813	0.354	0.630	MLE-3875-4813-B-1
3.875	4.813	0.354	0.709	LWE-3875-4813-1-1
3.875	4.813	0.375	0.750	LSE-3875-4813-1-1
3.875	4.813	0.375	0.750	FSE-3875-4813-1-1
3.875	4.813	0.562	0.562	LNE-3875-4813-1-1
3.875	4.813	0.591	0.591	FNE-3875-4813-1-1
3.875	4.875	0.354	0.630	MLE-3875-4875-B-1
3.875	4.875	0.354	0.709	LWE-3875-4875-1-1
3.875	4.875	0.375	0.750	LSE-3875-4875-1-1
3.875	4.875	0.375	0.750	FSE-3875-4875-1-1
3.875	4.875	0.562	0.562	LNE-3875-4875-1-1
3.875	4.875	0.591	0.591	FNE-3875-4875-1-1
3.875	4.938	0.354	0.630	MLE-3875-4938-B-1
3.875	4.938	0.354	0.709	LWE-3875-4938-1-1
3.875	4.938	0.375	0.750	LSE-3875-4938-1-1
3.875	4.938	0.375	0.750	FSE-3875-4938-1-1
3.875	4.938	0.562	0.562	LNE-3875-4938-1-1
3.875	4.938	0.591	0.591	FNE-3875-4938-1-1



03/03/06

See **Section 4** for seal part number prefix description.



Shaft Dia.	Bore Dia.	Total In Bore Depth	Total Seal Width	ProTech Part Number
3.875	5.000	0.354	0.630	MLE-3875-5000-B-1
3.875	5.000	0.354	0.709	LWE-3875-5000-1-1
3.875	5.000	0.375	0.750	LSE-3875-5000-1-1
3.875	5.000	0.375	0.750	FSE-3875-5000-1-1
3.875	5.000	0.562	0.562	LNE-3875-5000-1-1
3.875	5.000	0.591	0.591	FNE-3875-5000-1-1
3.875	5.062	0.375	0.750	LSE-3875-5062-1-1
3.875	5.062	0.375	0.750	FSE-3875-5062-1-1
3.875	5.062	0.562	0.562	LNE-3875-5062-1-1
3.875	5.062	0.591	0.591	FNE-3875-5062-1-1
3.875	5.063	0.354	0.630	MLE-3875-5063-B-1
3.875	5.063	0.354	0.709	LWE-3875-5063-1-1
3.875	5.125	0.354	0.630	MLE-3875-5125-B-1
3.875	5.125	0.354	0.709	LWE-3875-5125-1-1
3.875	5.125	0.375	0.750	LSE-3875-5125-1-1
3.875	5.125	0.375	0.750	FSE-3875-5125-1-1
3.875	5.125	0.562	0.562	LNE-3875-5125-1-1
3.875	5.125	0.591	0.591	FNE-3875-5125-1-1
3.875	5.188	0.354	0.630	MLE-3875-5188-B-1
3.875	5.188	0.354	0.709	LWE-3875-5188-1-1
3.875	5.188	0.375	0.750	LSE-3875-5188-1-1
3.875	5.188	0.375	0.750	FSE-3875-5188-1-1
3.875	5.188	0.562	0.562	LNE-3875-5188-1-1
3.875	5.188	0.591	0.591	FNE-3875-5188-1-1
3.875	5.250	0.354	0.630	MLE-3875-5250-B-1
3.875	5.250	0.354	0.709	LWE-3875-5250-1-1
3.875	5.250	0.375	0.750	LSE-3875-5250-1-1
3.875	5.250	0.375	0.750	FSE-3875-5250-1-1
3.875	5.250	0.562	0.562	LNE-3875-5250-1-1
3.875	5.250	0.591	0.591	FNE-3875-5250-1-1
3.875	5.312	0.375	0.750	LSE-3875-5312-1-1
3.875	5.313	0.354	0.630	MLE-3875-5313-B-1
3.875	5.313	0.354	0.709	LWE-3875-5313-1-1
3.875	5.375	0.354	0.630	MLE-3875-5375-B-1
3.875	5.375	0.354	0.709	LWE-3875-5375-1-1
3.875	5.375	0.375	0.750	LSE-3875-5375-1-1
3.875	5.375	0.375	0.750	FSE-3875-5375-1-1
3.875	5.375	0.562	0.562	LNE-3875-5375-1-1
3.875	5.375	0.591	0.591	FNE-3875-5375-1-1
3.938	4.563	0.375	0.750	LSE-3938-4563-1-1
3.938	4.625	0.375	0.750	LSE-3938-4625-1-1
3.938	4.688	0.375	0.750	LSE-3938-4688-1-1
3.938	4.688	0.375	0.750	FSE-3938-4688-1-1
3.938	4.688	0.562	0.562	LNE-3938-4688-1-1
3.938	4.688	0.591	0.591	FNE-3938-4688-1-1
3.938	4.750	0.375	0.750	LSE-3938-4750-1-1
3.938	4.750	0.375	0.750	FSE-3938-4750-1-1
3.938	4.750	0.562	0.562	LNE-3938-4750-1-1
3.938	4.750	0.591	0.591	FNE-3938-4750-1-1
3.938	4.813	0.354	0.630	MLE-3938-4813-B-1
3.938	4.813	0.354	0.709	LWE-3938-4813-1-1
3.938	4.813	0.375	0.750	LSE-3938-4813-1-1
3.938	4.813	0.375	0.750	FSE-3938-4813-1-1
3.938	4.813	0.562	0.562	LNE-3938-4813-1-1
3.938	4.813	0.591	0.591	FNE-3938-4813-1-1
3.938	4.875	0.354	0.630	MLE-3938-4875-B-1
3.938	4.875	0.354	0.709	LWE-3938-4875-1-1
3.938	4.875	0.375	0.750	LSE-3938-4875-1-1
3.938	4.875	0.375	0.750	FSE-3938-4875-1-1
3.938	4.875	0.562	0.562	LNE-3938-4875-1-1
3.938	4.875	0.591	0.591	FNE-3938-4875-1-1
3.938	4.938	0.354	0.630	MLE-3938-4938-B-1
3.938	4.938	0.354	0.709	LWE-3938-4938-1-1
3.938	4.938	0.375	0.750	LSE-3938-4938-1-1
3.938	4.938	0.375	0.750	FSE-3938-4938-1-1
3.938	4.938	0.562	0.562	LNE-3938-4938-1-1

Shaft Dia.	Bore Dia.	Total In Bore Depth	Total Seal Width	ProTech Part Number
3.938	4.938	0.591	0.591	FNE-3938-4938-1-1
3.938	5.000	0.354	0.630	MLE-3938-5000-B-1
3.938	5.000	0.354	0.709	LWE-3938-5000-1-1
3.938	5.000	0.375	0.750	LSE-3938-5000-1-1
3.938	5.000	0.375	0.750	FSE-3938-5000-1-1
3.938	5.000	0.562	0.562	LNE-3938-5000-1-1
3.938	5.000	0.591	0.591	FNE-3938-5000-1-1
3.938	5.063	0.354	0.630	MLE-3938-5063-B-1
3.938	5.063	0.354	0.709	LWE-3938-5063-1-1
3.938	5.063	0.375	0.750	LSE-3938-5063-1-1
3.938	5.063	0.375	0.750	FSE-3938-5063-1-1
3.938	5.063	0.562	0.562	LNE-3938-5063-1-1
3.938	5.063	0.591	0.591	FNE-3938-5063-1-1
3.938	5.125	0.354	0.630	MLE-3938-5125-B-1
3.938	5.125	0.354	0.709	LWE-3938-5125-1-1
3.938	5.125	0.375	0.750	LSE-3938-5125-1-1
3.938	5.125	0.375	0.750	FSE-3938-5125-1-1
3.938	5.125	0.562	0.562	LNE-3938-5125-1-1
3.938	5.125	0.591	0.591	FNE-3938-5125-1-1
3.938	5.188	0.354	0.630	MLE-3938-5188-B-1
3.938	5.188	0.354	0.709	LWE-3938-5188-1-1
3.938	5.188	0.375	0.750	LSE-3938-5188-1-1
3.938	5.188	0.375	0.750	FSE-3938-5188-1-1
3.938	5.188	0.562	0.562	LNE-3938-5188-1-1
3.938	5.188	0.591	0.591	FNE-3938-5188-1-1
3.938	5.250	0.354	0.630	MLE-3938-5250-B-1
3.938	5.250	0.354	0.709	LWE-3938-5250-1-1
3.938	5.250	0.375	0.750	LSE-3938-5250-1-1
3.938	5.250	0.375	0.750	FSE-3938-5250-1-1
3.938	5.250	0.562	0.562	LNE-3938-5250-1-1
3.938	5.250	0.591	0.591	FNE-3938-5250-1-1
3.938	5.313	0.354	0.630	MLE-3938-5313-B-1
3.938	5.313	0.354	0.709	LWE-3938-5313-1-1
3.938	5.313	0.375	0.750	LSE-3938-5313-1-1
3.938	5.313	0.375	0.750	FSE-3938-5313-1-1
3.938	5.313	0.562	0.562	LNE-3938-5313-1-1
3.938	5.313	0.591	0.591	FNE-3938-5313-1-1
3.938	5.375	0.354	0.630	MLE-3938-5375-B-1
3.938	5.375	0.354	0.709	LWE-3938-5375-1-1
3.938	5.375	0.375	0.750	LSE-3938-5375-1-1
3.938	5.375	0.375	0.750	FSE-3938-5375-1-1
3.938	5.375	0.562	0.562	LNE-3938-5375-1-1
3.938	5.375	0.591	0.591	FNE-3938-5375-1-1
3.938	5.438	0.354	0.630	MLE-3938-5438-B-1
3.938	5.438	0.354	0.709	LWE-3938-5438-1-1
3.938	5.438	0.375	0.750	LSE-3938-5438-1-1
3.938	5.438	0.375	0.750	FSE-3938-5438-1-1
3.938	5.438	0.562	0.562	LNE-3938-5438-1-1
3.938	5.438	0.591	0.591	FNE-3938-5438-1-1
4.000	4.750	0.375	0.750	FSE-4000-4750-1-1
4.000	4.750	0.591	0.591	FNE-4000-4750-1-1
4.000	4.813	0.375	0.750	FSE-4000-4813-1-1
4.000	4.813	0.591	0.591	FNE-4000-4813-1-1
4.000	4.875	0.354	0.630	MLE-4000-4875-B-1
4.000	4.875	0.354	0.709	LWE-4000-4875-1-1
4.000	4.875	0.375	0.750	LSE-4000-4875-5-1
4.000	4.875	0.375	0.750	FSE-4000-4875-1-1
4.000	4.875	0.562	0.562	LSE-4000-4875-5-1
4.000	4.875	0.591	0.591	FNE-4000-4875-1-1
4.000	4.938	0.354	0.630	MLE-4000-4938-B-1
4.000	4.938	0.354	0.709	LWE-4000-4938-1-1
4.000	4.938	0.375	0.750	LSE-4000-4938-5-1
4.000	4.938	0.375	0.750	FSE-4000-4938-1-1
4.000	4.938	0.562	0.562	LSE-4000-4938-5-1
4.000	4.938	0.591	0.591	FNE-4000-4938-1-1
4.000	5.000	0.354	0.630	MLE-4000-5000-B-1

See Section 4 for seal part number prefix description.

03/03/06



4.000 to 4.000

Shaft Dia.	Bore Dia.	Total In Bore Depth	Total Seal Width	ProTech Part Number
4.000	5.000	0.354	0.709	LWE-4000-5000-1-1
4.000	5.000	0.375	0.750	LSE-4000-5000-5-1
4.000	5.000	0.375	0.750	FSE-4000-5000-1-1
4.000	5.000	0.562	0.562	LSE-4000-5000-5-1
4.000	5.000	0.591	0.591	FNE-4000-5000-1-1
4.000	5.062	0.375	0.750	LSE-4000-5062-5-1
4.000	5.062	0.375	0.750	FSE-4000-5062-1-1
4.000	5.062	0.562	0.562	LSE-4000-5062-5-1
4.000	5.062	0.591	0.591	FNE-4000-5062-1-1
4.000	5.063	0.354	0.630	MLE-4000-5063-B-1
4.000	5.063	0.354	0.709	LWE-4000-5063-1-1
4.000	5.125	0.354	0.630	MLE-4000-5125-B-1
4.000	5.125	0.354	0.709	LWE-4000-5125-1-1
4.000	5.125	0.375	0.750	LSE-4000-5125-5-1
4.000	5.125	0.375	0.750	FSE-4000-5125-1-1
4.000	5.125	0.562	0.562	LSE-4000-5125-5-1
4.000	5.125	0.591	0.591	FNE-4000-5125-1-1
4.000	5.188	0.354	0.630	MLE-4000-5188-B-1
4.000	5.188	0.354	0.709	LWE-4000-5188-1-1
4.000	5.188	0.375	0.750	LSE-4000-5188-5-1
4.000	5.188	0.375	0.750	FSE-4000-5188-1-1
4.000	5.188	0.562	0.562	LSE-4000-5188-5-1
4.000	5.188	0.591	0.591	FNE-4000-5188-1-1
4.000	5.250	0.354	0.630	MLE-4000-5250-B-1
4.000	5.250	0.354	0.709	LWE-4000-5250-1-1
4.000	5.250	0.375	0.750	LSE-4000-5250-5-1
4.000	5.250	0.375	0.750	FSE-4000-5250-1-1
4.000	5.250	0.562	0.562	LSE-4000-5250-5-1

Shaft Dia.	Bore Dia.	Total In Bore Depth	Total Seal Width	ProTech Part Number
4.000	5.250	0.591	0.591	FNE-4000-5250-1-1
4.000	5.312	0.375	0.750	LSE-4000-5312-5-1
4.000	5.312	0.375	0.750	FSE-4000-5312-1-1
4.000	5.312	0.562	0.562	LSE-4000-5312-5-1
4.000	5.312	0.591	0.591	FNE-4000-5312-1-1
4.000	5.313	0.354	0.630	MLE-4000-5313-B-1
4.000	5.313	0.354	0.709	LWE-4000-5313-1-1
4.000	5.375	0.354	0.630	MLE-4000-5375-B-1
4.000	5.375	0.354	0.709	LWE-4000-5375-1-1
4.000	5.375	0.375	0.750	LSE-4000-5375-5-1
4.000	5.375	0.375	0.750	FSE-4000-5375-1-1
4.000	5.375	0.562	0.562	LSE-4000-5375-5-1
4.000	5.375	0.591	0.591	FNE-4000-5375-1-1
4.000	5.438	0.354	0.630	MLE-4000-5438-B-1
4.000	5.438	0.354	0.709	LWE-4000-5438-1-1
4.000	5.438	0.375	0.750	LSE-4000-5438-5-1
4.000	5.438	0.375	0.750	FSE-4000-5438-1-1
4.000	5.438	0.562	0.562	LSE-4000-5438-5-1
4.000	5.438	0.591	0.591	FNE-4000-5438-1-1
4.000	5.500	0.354	0.630	MLE-4000-5500-B-1
4.000	5.500	0.354	0.709	LWE-4000-5500-1-1
4.000	5.500	0.375	0.750	LSE-4000-5500-5-1
4.000	5.500	0.375	0.750	FSE-4000-5500-1-1
4.000	5.500	0.562	0.562	LSE-4000-5500-5-1
4.000	5.500	0.591	0.591	FNE-4000-5500-1-1



See **Section 4** for seal part number prefix description.

03/03/06



ProTech™ Sizes Metric

12.7 to 30.0

Catalog EPS 5350/USA

Shaft Dia.	Bore Dia.	Total In Bore Depth	Total Seal Width	ProTech Part Number
12.7	22.6	7.0	16.0	LSM-0127-0226-1-1
12.7	22.7	7.0	16.0	LSM-0127-0227-1-1
12.7	26.7	10.0	10.0	LNM-0127-0267-1-1
12.7	28.6	10.0	10.0	LNM-0127-0286-1-1
13.0	32.0	15.0	15.0	FNM-0130-0320-1-1
15.0	26.0	7.0	16.0	LSM-0150-0260-1-1
15.0	29.0	10.0	10.0	LNM-0150-0290-1-1
15.0	30.0	10.0	10.0	LNM-0150-0300-1-1
15.0	35.0	10.0	10.0	LNM-0150-0350-1-1
15.0	40.0	7.0	16.0	LSM-0150-0400-1-1
15.8	28.5	7.0	16.0	LSM-0158-0285-1-1
15.9	28.6	7.0	16.0	LSM-0159-0286-1-1
16.0	32.0	10.0	10.0	LNM-0160-0320-1-1
16.0	32.0	10.0	10.0	LNM-0160-0320-1-5
16.0	32.0	10.0	10.0	LNM-0160-0320-1-5
16.0	35.0	7.0	16.0	LSM-0160-0350-1-1
17.0	35.0	10.0	10.0	LNM-0170-0350-1-1
17.0	40.0	7.0	16.0	LSM-0170-0400-1-1
18.0	35.0	7.0	16.0	LSM-0180-0350-1-1
20.0	35.0	7.0	16.0	LSM-0200-0350-1-1
20.0	36.0	7.0	16.0	LSM-0200-0360-1-1
20.0	40.0	7.0	16.0	LSM-0200-0400-1-1
20.0	40.0	8.0	17.0	FSM-0200-0400-1-1
20.0	40.0	10.0	10.0	LNM-0200-0400-1-1
20.0	40.0	15.0	15.0	FNM-0200-0400-1-1
20.0	42.0	7.0	16.0	LSM-0200-0420-1-1
20.0	42.0	10.0	10.0	LNM-0200-0420-1-1
20.0	45.0	7.0	16.0	LSM-0200-0450-1-1
20.0	46.7	10.0	10.0	LNM-0200-0467-1-1
20.0	47.0	7.0	16.0	LSM-0200-0470-1-1
20.0	47.0	10.0	10.0	LNM-0200-0470-1-1
20.0	52.0	10.0	10.0	LNM-0200-0520-1-1
21.0	35.0	10.0	10.0	LNM-0210-0350-1-1
22.0	35.0	7.0	16.0	LSM-0220-0350-1-1
22.0	37.0	7.0	16.0	LSM-0220-0370-1-1
22.0	40.0	7.0	16.0	LSM-0220-0400-1-1
22.0	40.0	7.0	16.0	LWM-0220-0400-1-1
22.0	41.0	8.0	17.0	FSM-0220-0410-1-1
22.0	42.0	7.0	16.0	LSM-0220-0420-1-1
22.0	42.0	8.0	17.0	FSM-0220-0420-1-1
22.0	42.0	15.0	15.0	FNM-0220-0420-1-1
24.0	34.0	7.0	16.0	LSM-0240-0340-1-1
24.0	38.0	10.0	10.0	LNM-0240-0380-1-1
24.0	40.0	7.0	16.0	LSM-0240-0400-1-1
24.0	40.0	7.0	16.0	LSM-0240-0400-1-1
24.0	40.0	10.0	10.0	LNM-0240-0400-1-1
24.0	44.0	8.0	17.0	FSM-0240-0440-1-1
24.0	45.0	7.0	16.0	LSM-0240-0450-1-1
24.0	50.0	7.0	16.0	LSM-0240-0500-1-1
24.0	50.8	7.0	16.0	LSM-0240-0508-1-1
24.0	50.8	7.0	16.0	LWM-0240-0508-1-1
24.5	52.0	10.0	10.0	LNM-0245-0520-1-1
25.0	35.0	7.0	16.0	LSM-0250-0350-1-1
25.0	35.0	10.0	10.0	LNM-0250-0350-2-6
25.0	38.0	7.0	16.0	LSM-0250-0380-1-1
25.0	39.0	7.0	16.0	LWM-0250-0390-1-1
25.0	39.0	10.0	10.0	LNM-0250-0390-1-1
25.0	40.0	7.0	16.0	LSM-0250-0400-1-1
25.0	40.0	10.0	10.0	LNM-0250-0400-2-6
25.0	40.5	10.0	10.0	LNM-0250-0405-1-1

Shaft Dia.	Bore Dia.	Total In Bore Depth	Total Seal Width	ProTech Part Number
25.0	42.0	7.0	16.0	LSM-0250-0420-1-1
25.0	45.0	7.0	16.0	LSM-0250-0450-1-1
25.0	45.0	10.0	10.0	LNM-0250-0450-1-1
25.0	47.0	7.0	16.0	LSM-0250-0470-1-1
25.0	47.0	7.0	16.0	LWM-0250-0470-1-1
25.0	47.0	10.0	10.0	LNM-0250-0470-1-1
25.0	48.0	7.0	16.0	LSM-0250-0480-1-1
25.0	49.0	7.0	16.0	LSM-0250-0490-1-1
25.0	50.0	7.0	16.0	LSM-0250-0500-1-1
25.0	50.0	7.0	16.0	LWM-0250-0500-1-1
25.0	50.0	10.0	10.0	LNM-0250-0500-1-1
25.0	50.4	15.0	15.0	FNM-0250-0504-1-1
25.0	51.0	7.0	16.0	LSM-0250-0510-1-1
25.0	52.0	7.0	16.0	LSM-0250-0520-1-1
25.0	52.0	10.0	10.0	LNM-0250-0520-1-1
25.0	52.0	15.0	15.0	FNM-0250-0520-1-1
25.0	55.0	10.0	10.0	LNM-0250-0550-4-1
25.0	62.0	7.0	16.0	LSM-0250-0620-1-1
25.4	38.1	7.0	16.0	LSM-0254-0381-1-1
26.0	47.0	8.0	17.0	FSM-0260-0470-1-1
26.0	47.0	10.0	10.0	LNM-0260-0470-1-1
27.0	44.5	10.0	10.0	LNM-0270-0445-1-1
27.5	50.0	7.0	16.0	LSM-0275-0500-1-1
28.0	40.0	7.0	16.0	LSM-0280-0400-1-1
28.0	45.0	7.0	16.0	LSM-0280-0450-1-1
28.0	47.0	7.0	16.0	LSM-0280-0470-1-1
28.0	47.0	10.0	10.0	LNM-0280-0470-1-1
28.0	48.5	7.0	16.0	LSM-0280-0485-1-1
28.0	52.0	7.0	16.0	LSM-0280-0520-1-1
28.0	54.0	7.0	16.0	LSM-0280-0540-1-1
28.0	68.0	8.0	17.0	FSM-0280-0680-1-1
28.5	50.8	7.0	16.0	LSM-0285-0508-1-1
28.6	44.5	10.0	10.0	LNM-0286-0445-1-1
28.6	47.6	10.0	10.0	LNM-0286-0476-1-1
29.6	44.0	7.0	16.0	LSM-0296-0440-1-1
30.0	40.0	7.0	16.0	LSM-0300-0400-1-1
30.0	42.0	7.0	16.0	LSM-0300-0420-1-1
30.0	42.0	7.0	16.0	LWM-0300-0420-1-1
30.0	44.0	7.0	16.0	LSM-0300-0440-1-1
30.0	44.0	10.0	10.0	LNM-0300-0440-1-1
30.0	45.0	7.0	16.0	LSM-0300-0450-1-1
30.0	45.0	10.0	10.0	LNM-0300-0450-1-1
30.0	46.0	7.0	16.0	LSM-0300-0460-1-1
30.0	47.0	7.0	16.0	LSM-0300-0470-1-1
30.0	47.0	7.0	16.0	LWM-0300-0470-1-1
30.0	47.0	10.0	10.0	LNM-0300-0470-1-1
30.0	48.0	7.0	16.0	LSM-0300-0480-1-1
30.0	48.0	10.0	10.0	LNM-0300-0480-2-6
30.0	50.0	7.0	16.0	LSM-0300-0500-1-1
30.0	50.0	8.0	17.0	FSM-0300-0500-1-1
30.0	50.0	8.0	17.0	FSM-0300-0500-1-1
30.0	50.0	10.0	10.0	LNM-0300-0500-1-1
30.0	50.0	15.0	15.0	FNM-0300-0500-1-1
30.0	50.5	7.0	16.0	LSM-0300-0505-1-1
30.0	51.0	7.0	16.0	LSM-0300-0510-1-1
30.0	52.0	7.0	16.0	LSM-0300-0520-1-1
30.0	52.0	10.0	10.0	LNM-0300-0520-1-1
30.0	52.0	15.0	15.0	FNM-0300-0520-1-1
30.0	53.4	10.0	10.0	LNM-0300-0534-1-1
30.0	55.0	7.0	16.0	LSM-0300-0550-1-1

F

See Section 4 for seal part number prefix description.

03/03/06



30.0 to 40.0

Shaft Dia.	Bore Dia.	Total In Bore Depth	Total Seal Width	ProTech Part Number
30.0	55.0	7.0	16.0	LWM-0300-0550-1-1
30.0	55.0	10.0	10.0	LNM-0300-0550-1-1
30.0	56.0	7.0	16.0	LSM-0300-0560-1-1
30.0	56.0	10.0	10.0	LNM-0300-0560-2-6
30.0	57.0	10.0	10.0	LNM-0300-0570-1-1
30.0	60.0	7.0	16.0	LSM-0300-0600-1-1
30.0	60.0	10.0	10.0	LNM-0300-0600-1-1
30.0	61.9	7.0	16.0	LSM-0300-0619-1-1
30.0	62.0	7.0	16.0	LSM-0300-0620-1-1
30.0	62.0	10.0	10.0	LNM-0300-0620-1-1
30.0	62.0	15.0	15.0	FNM-0300-0620-1-1
30.0	65.0	10.0	10.0	LNM-0300-0650-1-1
30.0	70.0	15.0	15.0	FNM-0300-0700-1-1
31.0	45.8	7.0	16.0	LSM-0310-0458-1-1
31.5	50.0	7.0	16.0	LSM-0315-0500-1-1
31.7	52.0	7.0	16.0	LSM-0317-0520-1-1
31.8	50.8	7.0	16.0	LSM-0318-0508-1-1
32.0	43.0	7.0	16.0	LSM-0320-0430-1-1
32.0	45.0	7.0	16.0	LSM-0320-0450-1-1
32.0	46.0	10.0	10.0	LNM-0320-0460-1-1
32.0	47.0	7.0	16.0	LSM-0320-0470-1-1
32.0	47.0	10.0	10.0	LNM-0320-0470-1-1
32.0	50.0	7.0	16.0	LSM-0320-0500-1-1
32.0	50.0	10.0	10.0	LNM-0320-0500-1-1
32.0	52.0	7.0	16.0	LSM-0320-0520-1-1
32.0	52.0	10.0	10.0	LNM-0320-0520-1-1
32.0	55.0	7.0	16.0	LWM-0320-0550-1-1
32.0	58.0	7.0	16.0	LSM-0320-0580-1-1
32.0	70.0	7.0	16.0	LSM-0320-0700-1-1
32.7	54.0	10.0	10.0	LNM-0327-0540-1-1
33.0	52.0	8.0	17.0	FSM-0330-0520-1-1
33.0	60.0	8.0	17.0	FSM-0330-0600-1-1
34.0	43.0	7.0	16.0	LSM-0340-0430-1-1
34.0	44.0	7.0	16.0	LSM-0340-0440-1-1
34.0	52.0	7.0	16.0	LSM-0340-0520-1-1
34.0	54.0	7.0	16.0	LSM-0340-0540-1-1
34.0	60.0	7.0	16.0	LSM-0340-0600-1-1
34.9	52.4	10.0	10.0	LNM-0349-0524-1-1
35.0	45.0	7.0	16.0	LWM-0350-0450-1-1
35.0	47.0	7.0	16.0	LSM-0350-0470-1-1
35.0	47.0	7.0	16.0	LWM-0350-0470-1-1
35.0	47.0	10.0	10.0	LNM-0350-0470-1-1
35.0	49.0	10.0	10.0	LNM-0350-0490-1-1
35.0	50.0	7.0	16.0	LSM-0350-0500-1-1
35.0	50.0	10.0	10.0	LNM-0350-0500-1-1
35.0	51.0	7.0	16.0	LSM-0350-0510-1-1
35.0	52.0	7.0	16.0	LSM-0350-0520-1-1
35.0	52.0	7.0	16.0	LWM-0350-0520-1-1
35.0	52.0	10.0	10.0	LNM-0350-0520-1-1
35.0	54.0	7.0	16.0	LSM-0350-0540-1-1
35.0	54.0	10.0	10.0	LNM-0350-0540-2-6
35.0	55.0	7.0	16.0	LSM-0350-0550-1-1
35.0	55.0	8.0	17.0	FSM-0350-0550-1-1
35.0	55.0	10.0	10.0	LNM-0350-0550-1-1
35.0	55.0	15.0	15.0	FNM-0350-0550-1-1
35.0	58.0	7.0	16.0	LSM-0350-0580-1-1
35.0	59.0	8.0	17.0	FSM-0350-0590-1-1
35.0	60.0	7.0	16.0	LSM-0350-0600-1-1
35.0	60.0	10.0	10.0	LNM-0350-0600-1-1
35.0	61.0	7.0	16.0	LSM-0350-0610-1-1
35.0	61.0	7.0	16.0	LSM-0350-0610-1-1
35.0	61.0	8.0	17.0	FSM-0350-0610-1-1
35.0	62.0	7.0	16.0	LSM-0350-0620-1-1
35.0	62.0	8.0	17.0	FSM-0350-0620-1-1
35.0	62.0	10.0	10.0	LNM-0350-0620-1-1
35.0	62.9	10.0	10.0	LNM-0350-0629-1-1

Shaft Dia.	Bore Dia.	Total In Bore Depth	Total Seal Width	ProTech Part Number
35.0	63.5	10.0	10.0	LNM-0350-0635-1-1
35.0	64.0	10.0	10.0	LNM-0350-0640-1-1
35.0	65.0	7.0	16.0	LSM-0350-0650-1-1
35.0	68.0	7.0	16.0	LSM-0350-0680-1-1
35.0	71.0	10.0	10.0	LNM-0350-0710-1-1
35.0	72.0	7.0	16.0	LSM-0350-0720-1-1
35.5	52.7	7.0	16.0	LSM-0355-0527-1-1
36.0	50.0	7.0	16.0	LSM-0360-0500-1-1
36.0	52.0	7.0	16.0	LSM-0360-0520-1-1
36.0	55.0	8.0	17.0	FSM-0360-0550-1-1
36.0	61.4	15.0	15.0	FNM-0360-0614-1-1
36.0	62.0	7.0	16.0	LSM-0360-0620-1-1
36.0	76.0	10.0	10.0	LNM-0360-0760-1-1
36.5	55.0	7.0	16.0	LSM-0365-0550-1-1
36.5	57.0	15.0	15.0	FNM-0365-0570-1-1
36.5	57.6	7.0	16.0	LSM-0365-0576-1-1
36.8	67.0	7.0	16.0	LSM-0368-0670-1-1
37.0	63.0	8.0	17.0	FSM-0370-0630-1-1
37.9	57.9	7.0	16.0	LSM-0379-0579-1-1
38.0	48.0	7.0	16.0	LSM-0380-0480-1-1
38.0	52.0	7.0	16.0	LSM-0380-0520-1-1
38.0	54.0	7.0	16.0	LSM-0380-0540-1-1
38.0	55.0	7.0	16.0	LSM-0380-0550-1-1
38.0	55.0	10.0	10.0	LNM-0380-0550-1-1
38.0	56.0	7.0	16.0	LSM-0380-0560-1-1
38.0	56.0	10.0	10.0	LNM-0380-0560-1-5
38.0	57.0	7.0	16.0	LSM-0380-0570-1-1
38.0	57.1	7.0	16.0	LSM-0380-0571-1-1
38.0	57.1	10.0	10.0	LNM-0380-0571-1-1
38.0	58.0	15.0	15.0	FNM-0380-0580-1-1
38.0	62.0	7.0	16.0	LSM-0380-0620-1-1
38.0	62.0	10.0	10.0	LNM-0380-0620-1-1
38.0	62.0	15.0	15.0	FNM-0380-0620-1-1
38.0	64.0	7.0	16.0	LSM-0380-0640-1-1
38.0	65.0	8.0	17.0	FSM-0380-0650-1-1
38.0	69.0	7.0	16.0	LSM-0380-0690-1-1
38.0	70.0	7.0	16.0	LSM-0380-0700-1-1
38.0	72.0	10.0	10.0	LNM-0380-0720-1-1
38.0	72.2	7.0	16.0	LSM-0380-0722-1-1
38.1	57.2	7.0	16.0	LSM-0381-0572-1-1
39.0	70.0	7.0	16.0	LSM-0390-0700-1-1
40.0	52.0	7.0	16.0	LSM-0400-0520-1-1
40.0	52.0	7.0	16.0	LWM-0400-0520-1-1
40.0	54.0	10.0	10.0	LNM-0400-0540-1-1
40.0	55.0	7.0	16.0	LSM-0400-0550-1-1
40.0	55.0	10.0	10.0	LNM-0400-0550-1-1
40.0	56.0	7.0	16.0	LSM-0400-0560-1-1
40.0	56.0	10.0	10.0	LNM-0400-0560-5-1
40.0	58.0	7.0	16.0	LSM-0400-0580-1-1
40.0	58.0	10.0	10.0	LNM-0400-0580-1-1
40.0	59.0	7.0	16.0	LSM-0400-0590-1-1
40.0	60.0	7.0	16.0	LSM-0400-0600-1-1
40.0	60.0	8.0	17.0	FSM-0400-0600-1-1
40.0	60.0	10.0	10.0	LNM-0400-0600-1-1
40.0	60.0	15.0	15.0	FNM-0400-0600-1-1
40.0	62.0	7.0	16.0	LSM-0400-0620-1-1
40.0	62.0	10.0	10.0	LNM-0400-0620-1-1
40.0	63.5	7.0	16.0	LSM-0400-0635-1-1
40.0	65.0	7.0	16.0	LSM-0400-0650-1-1
40.0	65.0	10.0	10.0	LNM-0400-0650-1-1
40.0	66.0	7.0	16.0	LSM-0400-0660-1-1
40.0	70.0	7.0	16.0	LSM-0400-0700-1-1
40.0	70.0	8.0	17.0	FSM-0400-0700-1-1
40.0	70.0	10.0	10.0	LNM-0400-0700-1-1
40.0	72.0	7.0	16.0	LWM-0400-0720-1-1
40.0	78.0	10.0	10.0	LNM-0400-0780-1-1



03/03/06

See Section 4 for seal part number prefix description.



Shaft Dia.	Bore Dia.	Total In Bore Depth	Total Seal Width	ProTech Part Number
40.0	80.0	7.0	16.0	LSM-0400-0800-1-1
40.0	80.0	10.0	10.0	LNM-0400-0800-1-1
41.0	60.0	15.0	15.0	FNM-0410-0600-1-1
41.0	66.0	8.0	17.0	LWM-0410-0660-1-1
41.3	63.5	10.0	10.0	LNM-0413-0635-1-1
42.0	55.0	8.0	17.0	LSM-0420-0550-1-1
42.0	58.0	8.0	17.0	LSM-0420-0580-1-1
42.0	60.0	8.0	17.0	LSM-0420-0600-1-1
42.0	60.0	10.0	10.0	LNM-0420-0600-1-1
42.0	62.0	8.0	17.0	LSM-0420-0620-1-1
42.0	62.0	8.0	17.0	LWM-0420-0620-1-1
42.0	62.0	10.0	10.0	LNM-0420-0620-1-1
42.0	68.0	8.0	17.0	LSM-0420-0680-1-1
42.0	72.0	8.0	17.0	LSM-0420-0720-1-1
42.0	72.0	10.0	10.0	LNM-0420-0720-1-1
42.0	82.0	8.0	17.0	LSM-0420-0820-1-1
42.5	68.7	8.0	17.0	LSM-0425-0687-1-1
43.0	57.0	10.0	10.0	LNM-0430-0570-1-1
43.0	60.0	8.0	17.0	LSM-0430-0600-1-1
43.0	60.0	10.0	10.0	LNM-0430-0600-1-5
43.0	62.0	8.0	17.0	FSM-0430-0620-1-1
43.0	62.0	8.0	17.0	LSM-0430-0620-1-1
43.0	62.0	10.0	10.0	LNM-0430-0620-1-1
43.0	68.0	8.0	17.0	FSM-0430-0680-1-1
43.0	69.9	8.0	17.0	LSM-0430-0699-1-1
43.0	69.9	10.0	10.0	LNM-0430-0699-1-1
43.0	76.5	8.0	17.0	LSM-0430-0765-1-1
43.0	76.5	10.0	10.0	LNM-0430-0765-1-1
43.5	71.0	8.0	17.0	LSM-0435-0710-1-1
44.0	58.0	8.0	17.0	LWM-0440-0580-5-3
44.0	60.0	10.0	10.0	LNM-0440-0600-1-1
44.0	62.0	10.0	10.0	LNM-0440-0620-1-1
44.0	64.0	15.0	15.0	FNM-0440-0640-1-1
44.0	65.0	10.0	10.0	LNM-0440-0650-1-1
44.0	75.0	8.0	17.0	LSM-0440-0750-1-1
44.3	60.2	10.0	10.0	LNM-0443-0602-1-1
44.4	70.0	15.0	15.0	FNM-0444-0700-1-1
44.4	73.0	8.0	17.0	LSM-0444-0730-1-1
44.5	62.0	10.0	10.0	LNM-0445-0620-1-1
44.5	63.5	8.0	17.0	LSM-0445-0635-1-1
44.5	66.7	8.0	17.0	LSM-0445-0667-1-1
44.5	70.0	10.0	10.0	LNM-0445-0700-1-1
44.9	60.0	8.0	17.0	LSM-0449-0600-1-1
45.0	59.6	8.0	17.0	LSM-0450-0596-1-1
45.0	60.0	8.0	17.0	LSM-0450-0600-1-1
45.0	60.0	10.0	10.0	LNM-0450-0600-1-1
45.0	61.0	8.0	17.0	LSM-0450-0610-1-1
45.0	61.0	10.0	10.0	LNM-0450-0610-1-1
45.0	61.3	10.0	10.0	LNM-0450-0613-1-1
45.0	62.0	8.0	17.0	LSM-0450-0620-1-1
45.0	62.0	10.0	10.0	LNM-0450-0620-1-1
45.0	62.0	10.0	10.0	LNM-0450-0620-2-6
45.0	63.0	8.0	17.0	LSM-0450-0630-1-1
45.0	64.0	10.0	10.0	LNM-0450-0640-2-1
45.0	64.0	15.0	15.0	FNM-0450-0640-1-1
45.0	65.0	8.0	17.0	FSM-0450-0650-1-1
45.0	65.0	8.0	17.0	LSM-0450-0650-1-1
45.0	65.0	8.0	17.0	LWM-0450-0650-1-1
45.0	65.0	10.0	10.0	LNM-0450-0650-1-1
45.0	65.0	10.0	10.0	LNM-0450-0650-1-5
45.0	67.0	8.0	17.0	LSM-0450-0670-1-1
45.0	68.0	8.0	17.0	LSM-0450-0680-1-1
45.0	68.0	10.0	10.0	LNM-0450-0680-1-1
45.0	69.0	8.0	17.0	LSM-0450-0690-1-1
45.0	70.0	8.0	17.0	FSM-0450-0700-1-1
45.0	70.0	8.0	17.0	LSM-0450-0700-1-1

Shaft Dia.	Bore Dia.	Total In Bore Depth	Total Seal Width	ProTech Part Number
45.0	70.0	10.0	10.0	LNM-0450-0700-1-1
45.0	70.0	15.0	15.0	FNM-0450-0700-1-1
45.0	70.4	8.0	17.0	FSM-0450-0704-1-1
45.0	71.0	8.0	17.0	LSM-0450-0710-1-1
45.0	71.0	10.0	10.0	LNM-0450-0710-1-1
45.0	72.0	8.0	17.0	LSM-0450-0720-1-1
45.0	72.0	10.0	10.0	LNM-0450-0720-1-1
45.0	73.0	8.0	17.0	LSM-0450-0730-1-1
45.0	75.0	10.0	10.0	LNM-0450-0750-1-1
45.0	78.0	10.0	10.0	LNM-0450-0780-1-1
45.0	80.0	8.0	17.0	LSM-0450-0800-1-1
45.0	80.0	10.0	10.0	LNM-0450-0800-1-1
45.0	85.0	8.0	17.0	LSM-0450-0850-1-1
46.0	64.0	10.0	10.0	LNM-0460-0640-1-1
46.0	72.0	8.0	17.0	LSM-0460-0720-1-6
47.0	65.0	8.0	17.0	LSM-0470-0650-1-1
47.6	65.0	10.0	10.0	LNM-0476-0650-1-1
47.6	75.0	8.0	17.0	LSM-0476-0750-1-1
47.7	78.0	8.0	17.0	LSM-0477-0780-1-1
48.0	62.0	8.0	17.0	LSM-0480-0620-1-1
48.0	64.0	8.0	17.0	LSM-0480-0640-1-1
48.0	68.0	8.0	17.0	FSM-0480-0680-1-1
48.0	68.0	8.0	17.0	LSM-0480-0680-1-1
48.0	68.0	10.0	10.0	LNM-0480-0680-1-1
48.0	68.7	8.0	17.0	LSM-0480-0687-1-1
48.0	70.0	8.0	17.0	LSM-0480-0700-1-1
48.0	72.0	8.0	17.0	LSM-0480-0720-1-1
48.0	72.0	10.0	10.0	LNM-0480-0720-1-1
48.0	74.0	8.0	17.0	LSM-0480-0740-1-1
48.0	75.0	8.0	17.0	LSM-0480-0750-1-1
49.0	76.0	8.0	17.0	LSM-0490-0760-1-1
49.9	75.3	8.0	17.0	LSM-0499-0753-1-1
50.0	64.0	10.0	10.0	LNM-0500-0640-1-1
50.0	65.0	8.0	17.0	LSM-0500-0650-1-1
50.0	65.0	10.0	10.0	LNM-0500-0650-1-1
50.0	66.0	8.0	17.0	LSM-0500-0660-1-1
50.0	66.0	10.0	10.0	LNM-0500-0660-1-1
50.0	68.0	8.0	17.0	LSM-0500-0680-1-1
50.0	68.0	10.0	10.0	LNM-0500-0680-1-1
50.0	70.0	8.0	17.0	FSM-0500-0700-1-1
50.0	70.0	8.0	17.0	FSM-0500-0700-5-1
50.0	70.0	8.0	17.0	LSM-0500-0700-1-1
50.0	70.0	10.0	10.0	LNM-0500-0700-1-1
50.0	72.0	8.0	17.0	LSM-0500-0720-1-1
50.0	72.0	8.0	17.0	LWM-0500-0720-1-1
50.0	72.0	10.0	10.0	LNM-0500-0720-1-1
50.0	75.0	8.0	17.0	LSM-0500-0750-1-1
50.0	75.0	10.0	10.0	LNM-0500-0750-1-1
50.0	76.0	8.0	17.0	FSM-0500-0760-1-1
50.0	76.0	8.0	17.0	LSM-0500-0760-1-1
50.0	76.0	10.0	10.0	LNM-0500-0760-1-1
50.0	79.5	10.0	10.0	LNM-0500-0795-1-1
50.0	80.0	8.0	17.0	LSM-0500-0800-1-1
50.0	80.0	10.0	10.0	LNM-0500-0800-1-1
50.0	80.0	15.0	15.0	FNM-0500-0800-1-1
50.0	85.0	8.0	17.0	LSM-0500-0850-5-1
50.0	86.0	8.0	17.0	FSM-0500-0860-1-1
50.0	90.0	8.0	17.0	LSM-0500-0900-1-1
50.0	90.0	10.0	10.0	LNM-0500-0900-1-1
50.0	90.0	10.0	10.0	LNM-0500-0900-1-1
50.8	69.9	10.0	10.0	LNM-0508-0699-1-1
50.8	75.0	8.0	17.0	LSM-0508-0750-1-1
50.8	76.2	8.0	17.0	LSM-0508-0762-1-1
51.0	76.2	8.0	17.0	LSM-0510-0762-1-1
51.5	66.7	10.0	10.0	LNM-0515-0667-1-1
52.0	68.0	8.0	17.0	LSM-0520-0680-1-1

See **Section 4** for seal part number prefix description.

03/03/06



52.0 to 63.0

Shaft Dia.	Bore Dia.	Total In Bore Depth	Total Seal Width	ProTech Part Number
52.0	68.0	10.0	10.0	LNM-0520-0680-1-1
52.0	72.0	8.0	17.0	LSM-0520-0720-1-1
52.0	72.0	10.0	10.0	LNM-0520-0720-1-1
52.4	76.2	10.0	10.0	LNM-0524-0762-1-1
54.0	68.1	10.0	10.0	LNM-0540-0681-1-1
54.0	72.0	8.0	17.0	LSM-0540-0720-1-1
54.0	73.0	8.0	17.0	LSM-0540-0730-1-1
54.0	73.0	10.0	10.0	LNM-0540-0730-1-1
54.0	78.0	8.0	17.0	LWM-0540-0780-1-1
54.0	79.4	8.0	17.0	LSM-0540-0794-1-1
54.0	90.0	8.0	17.0	LSM-0540-0900-1-1
55.0	68.0	8.0	17.0	LSM-0550-0680-5-1
55.0	70.0	8.0	17.0	LSM-0550-0700-1-1
55.0	70.0	8.0	17.0	LSM-0550-0700-5-1
55.0	70.0	8.0	17.0	LWM-0550-0700-1-1
55.0	70.0	10.0	10.0	LNM-0550-0700-1-1
55.0	70.5	8.0	17.0	LSM-0550-0705-1-1
55.0	71.0	8.0	17.0	LSM-0550-0710-1-1
55.0	72.0	8.0	17.0	LSM-0550-0720-1-1
55.0	72.0	10.0	10.0	LNM-0550-0720-1-1
55.0	73.0	8.0	17.0	LSM-0550-0730-1-1
55.0	73.0	10.0	10.0	LNM-0550-0730-1-1
55.0	75.0	8.0	17.0	LSM-0550-0750-1-1
55.0	75.0	8.0	17.0	LSM-0550-0750-2-6
55.0	75.0	10.0	10.0	LNM-0550-0750-1-1
55.0	75.0	15.0	15.0	FNM-0550-0750-1-1
55.0	75.3	8.0	17.0	FSM-0550-0753-1-1
55.0	76.0	10.0	10.0	LNM-0550-0760-1-1
55.0	77.0	8.0	17.0	LSM-0550-0770-1-1
55.0	78.0	8.0	17.0	LSM-0550-0780-1-1
55.0	78.0	10.0	10.0	LNM-0550-0780-1-1
55.0	80.0	8.0	17.0	FSM-0550-0800-1-1
55.0	80.0	8.0	17.0	LSM-0550-0800-1-1
55.0	80.0	10.0	10.0	LNM-0550-0800-1-1
55.0	80.0	15.0	15.0	FNM-0550-0800-1-1
55.0	80.4	8.0	17.0	FSM-0550-0804-1-1
55.0	81.0	8.0	17.0	LSM-0550-0810-1-1
55.0	82.0	8.0	17.0	LSM-0550-0820-1-1
55.0	83.0	8.0	17.0	LSM-0550-0830-1-1
55.0	85.0	8.0	17.0	FSM-0550-0850-1-1
55.0	85.0	8.0	17.0	LSM-0550-0850-1-1
55.0	85.0	10.0	10.0	LNM-0550-0850-1-1
55.0	85.0	15.0	15.0	FNM-0550-0850-1-1
55.0	85.5	10.0	10.0	LNM-0550-0855-1-1
55.0	90.0	8.0	17.0	FSM-0550-0900-1-1
55.0	90.0	8.0	17.0	FSM-0550-0900-1-1
55.0	90.0	8.0	17.0	LSM-0550-0900-1-1
55.0	90.0	10.0	10.0	LNM-0550-0900-1-1
55.0	90.0	15.0	15.0	FNM-0550-0900-1-1
55.0	92.0	10.0	10.0	LNM-0550-0920-1-3
55.5	83.5	8.0	17.0	LSM-0555-0835-1-1
56.0	80.0	8.0	17.0	FSM-0560-0800-1-1
56.0	90.0	10.0	10.0	LNM-0560-0900-1-1
56.7	70.0	8.0	17.0	LSM-0567-0700-1-1
57.0	71.0	10.0	10.0	LNM-0570-0710-1-1
57.0	72.0	10.0	10.0	LNM-0570-0720-1-1
57.0	75.0	8.0	17.0	LSM-0570-0750-1-1
57.0	76.0	8.0	17.0	FSM-0570-0760-1-1
57.0	76.2	8.0	17.0	LSM-0570-0762-1-1
57.0	77.0	10.0	10.0	LNM-0570-0770-1-1
57.0	78.0	8.0	17.0	LSM-0570-0780-1-1
57.0	80.0	10.0	10.0	LNM-0570-0800-1-1
57.0	83.0	8.0	17.0	LSM-0570-0830-4-1
57.1	73.0	8.0	17.0	LWM-0571-0730-5-1
57.4	85.5	8.0	17.0	LSM-0574-0855-1-1
57.5	79.7	8.0	17.0	LSM-0575-0797-1-1

Shaft Dia.	Bore Dia.	Total In Bore Depth	Total Seal Width	ProTech Part Number
57.8	90.0	8.0	17.0	LSM-0578-0900-1-1
58.0	76.0	8.0	17.0	LSM-0580-0760-1-1
58.0	78.0	8.0	17.0	FSM-0580-0780-1-1
58.0	80.0	8.0	17.0	FSM-0580-0800-1-1
58.0	80.0	8.0	17.0	LSM-0580-0800-1-1
58.0	80.0	8.0	17.0	LWM-0580-0800-1-1
58.5	80.0	8.0	17.0	LSM-0585-0800-1-1
58.7	80.0	8.0	17.0	LSM-0587-0800-1-1
58.7	90.0	8.0	17.0	LSM-0587-0900-1-1
59.0	80.0	8.0	17.0	LSM-0590-0800-1-1
59.4	78.5	10.0	10.0	LNM-0594-0785-1-1
59.5	75.0	8.0	17.0	LSM-0595-0750-1-1
59.8	79.8	8.0	17.0	LSM-0598-0798-1-1
59.8	79.8	10.0	10.0	LNM-0598-0798-1-1
60.0	72.0	8.0	17.0	LSM-0600-0720-1-1
60.0	74.0	10.0	10.0	LNM-0600-0740-1-1
60.0	75.0	8.0	17.0	LSM-0600-0750-1-1
60.0	75.0	8.0	17.0	LSM-0600-0750-5-1
60.0	75.0	10.0	10.0	LNM-0600-0750-1-1
60.0	75.9	8.0	17.0	LSM-0600-0759-1-1
60.0	76.0	8.0	17.0	LSM-0600-0760-1-1
60.0	78.0	8.0	17.0	LSM-0600-0780-1-1
60.0	79.0	10.0	10.0	LNM-0600-0790-1-1
60.0	80.0	8.0	17.0	FSM-0600-0800-1-1
60.0	80.0	8.0	17.0	FSM-0600-0800-1-1
60.0	80.0	8.0	17.0	LSM-0600-0800-1-1
60.0	80.0	8.0	17.0	LWM-0600-0800-1-1
60.0	80.0	10.0	10.0	LNM-0600-0800-1-1
60.0	80.0	15.0	15.0	FNM-0600-0800-1-1
60.0	82.0	8.0	17.0	FSM-0600-0820-1-1
60.0	82.0	8.0	17.0	LSM-0600-0820-1-1
60.0	82.0	10.0	10.0	LNM-0600-0820-1-1
60.0	82.4	8.0	17.0	LSM-0600-0824-1-1
60.0	84.0	8.0	17.0	LSM-0600-0840-1-1
60.0	85.0	8.0	17.0	LSM-0600-0850-1-1
60.0	85.0	10.0	10.0	LNM-0600-0850-1-1
60.0	85.0	15.0	15.0	FNM-0600-0850-1-1
60.0	86.0	8.0	17.0	FSM-0600-0860-1-1
60.0	86.0	8.0	17.0	LSM-0600-0860-1-1
60.0	86.0	10.0	10.0	LNM-0600-0860-1-1
60.0	86.0	10.0	10.0	LNM-0600-0860-5-1
60.0	88.5	8.0	17.0	LSM-0600-0885-1-1
60.0	88.9	10.0	10.0	LNM-0600-0889-1-1
60.0	89.0	10.0	10.0	LNM-0600-0890-1-1
60.0	90.0	8.0	17.0	LSM-0600-0900-1-1
60.0	90.0	10.0	10.0	LNM-0600-0900-1-1
60.0	92.0	8.0	17.0	LSM-0600-0920-1-1
60.0	95.0	8.0	17.0	LSM-0600-0950-1-1
60.0	100.0	8.0	17.0	FSM-0600-1000-1-1
60.0	100.0	8.0	17.0	LSM-0600-1000-1-1
60.0	100.0	10.0	10.0	LNM-0600-1000-1-1
60.0	110.0	10.0	10.0	LNM-0600-1100-1-1
60.3	82.5	9.0	18.0	LSM-0603-0825-1-1
60.8	90.0	9.0	18.0	LSM-0608-0900-1-1
61.0	100.0	8.0	17.0	FSM-0610-1000-1-1
61.8	80.0	9.0	18.0	LSM-0618-0800-1-1
61.9	81.9	10.0	10.0	LNM-0619-0819-1-1
62.0	78.0	9.0	18.0	LSM-0620-0780-1-1
62.0	80.0	9.0	18.0	LSM-0620-0800-1-1
62.0	80.0	10.0	10.0	LNM-0620-0800-1-1
62.0	84.0	9.0	18.0	LSM-0620-0840-1-1
62.0	85.0	9.0	18.0	LSM-0620-0850-1-1
62.0	85.0	10.0	10.0	LNM-0620-0850-1-1
62.0	90.0	10.0	10.0	LNM-0620-0900-1-1
62.0	90.0	10.0	10.0	LNM-0620-0900-1-1
63.0	80.0	9.0	18.0	LSM-0630-0800-1-1



03/03/06

See Section 4 for seal part number prefix description.



Shaft Dia.	Bore Dia.	Total In Bore Depth	Total Seal Width	ProTech Part Number
63.0	80.0	10.0	10.0	LNM-0630-0800-1-1
63.0	82.0	8.0	17.0	FSM-0630-0820-1-1
63.0	85.0	10.0	10.0	LNM-0630-0850-1-1
63.0	85.0	15.0	15.0	FNM-0630-0850-1-1
63.0	89.0	9.0	18.0	LSM-0630-0890-1-1
63.0	90.0	9.0	18.0	LSM-0630-0900-1-1
63.0	90.0	10.0	10.0	LNM-0630-0900-1-1
63.4	90.2	9.0	18.0	LSM-0634-0902-1-1
63.5	79.0	9.0	18.0	LSM-0635-0790-1-1
63.5	82.0	9.0	18.0	LSM-0635-0820-1-1
63.5	82.5	9.0	18.0	LSM-0635-0825-1-1
63.5	88.5	9.0	18.0	LSM-0635-0885-1-1
63.5	91.0	9.0	18.0	LSM-0635-0910-1-1
63.5	92.0	9.0	18.0	LSM-0635-0920-1-1
63.9	102.0	10.0	10.0	LNM-0639-1020-1-1
64.0	90.0	9.0	18.0	LSM-0640-0900-1-1
65.0	79.0	10.0	10.0	LNM-0650-0790-1-1
65.0	80.0	9.0	18.0	LSM-0650-0800-1-1
65.0	80.0	10.0	10.0	LNM-0650-0800-1-1
65.0	82.0	9.0	18.0	LSM-0650-0820-1-1
65.0	84.0	8.0	17.0	FSM-0650-0840-1-1
65.0	85.0	8.0	17.0	FSM-0650-0850-1-1
65.0	85.0	9.0	18.0	LSM-0650-0850-1-1
65.0	85.0	10.0	10.0	LNM-0650-0850-1-1
65.0	85.0	15.0	15.0	FNM-0650-0850-1-1
65.0	88.0	9.0	18.0	LSM-0650-0880-1-1
65.0	88.0	10.0	10.0	LNM-0650-0880-1-1
65.0	90.0	8.0	17.0	FSM-0650-0900-1-1
65.0	90.0	9.0	18.0	LSM-0650-0900-1-1
65.0	90.0	10.0	10.0	LNM-0650-0900-1-1
65.0	90.0	10.0	10.0	LNM-0650-0900-5-1
65.0	90.4	9.0	18.0	LSM-0650-0904-1-1
65.0	91.0	8.0	17.0	FSM-0650-0910-1-1
65.0	91.0	9.0	18.0	LSM-0650-0910-1-1
65.0	91.0	9.0	18.0	LWM-0650-0910-5-3
65.0	92.0	9.0	18.0	LSM-0650-0920-1-1
65.0	92.0	10.0	10.0	LNM-0650-0920-1-1
65.0	93.0	9.0	18.0	LSM-0650-0930-1-1
65.0	95.0	8.0	17.0	FSM-0650-0950-1-1
65.0	95.0	10.0	10.0	LNM-0650-0950-1-1
65.0	100.0	8.0	17.0	FSM-0650-1000-1-1
65.0	100.0	9.0	18.0	LSM-0650-1000-1-1
65.0	100.0	10.0	10.0	LNM-0650-1000-1-1
65.0	100.0	15.0	15.0	FNM-0650-1000-1-1
65.0	103.0	9.0	18.0	LSM-0650-1030-1-1
66.0	94.0	9.0	18.0	LSM-0660-0940-1-1
66.5	93.0	9.0	18.0	LSM-0665-0930-1-1
66.6	92.0	9.0	18.0	LSM-0666-0920-1-1
66.6	92.1	10.0	10.0	LNM-0666-0921-1-1
66.7	82.6	9.0	18.0	LWM-0667-0826-5-1
66.7	92.0	9.0	18.0	LSM-0667-0920-1-1
67.0	85.0	9.0	18.0	LSM-0670-0850-1-1
67.0	110.0	9.0	18.0	LSM-0670-1100-1-1
67.6	95.0	9.0	18.0	LSM-0676-0950-1-1
68.0	85.0	9.0	18.0	LSM-0680-0850-1-1
68.0	85.0	10.0	10.0	LNM-0680-0850-1-1
68.0	88.0	10.0	10.0	LNM-0680-0880-1-1
68.0	90.0	8.0	17.0	FSM-0680-0900-1-1
68.0	90.0	8.0	17.0	FSM-0680-0900-1-1
68.0	90.0	9.0	18.0	LSM-0680-0900-1-1
68.0	90.0	10.0	10.0	LNM-0680-0900-1-1
68.0	95.0	9.0	18.0	LSM-0680-0950-1-1
68.3	91.0	9.0	18.0	LSM-0683-0910-1-1
69.0	89.0	10.0	10.0	LNM-0690-0890-1-1
69.2	89.2	10.0	10.0	LNM-0692-0892-1-1
69.6	90.0	9.0	18.0	LSM-0696-0900-1-1

Shaft Dia.	Bore Dia.	Total In Bore Depth	Total Seal Width	ProTech Part Number
69.9	90.0	9.0	18.0	LSM-0699-0900-1-1
69.9	98.5	9.0	18.0	LSM-0699-0985-1-1
70.0	85.0	9.0	18.0	LSM-0700-0850-1-1
70.0	85.0	10.0	10.0	LNM-0700-0850-1-1
70.0	86.0	9.0	18.0	LSM-0700-0860-1-1
70.0	90.0	8.0	17.0	FSM-0700-0900-1-1
70.0	90.0	9.0	18.0	LSM-0700-0900-1-1
70.0	90.0	9.0	18.0	LWM-0700-0900-1-1
70.0	90.0	10.0	10.0	LNM-0700-0900-1-1
70.0	90.0	15.0	15.0	FNM-0700-0900-1-1
70.0	92.0	9.0	18.0	LSM-0700-0920-1-1
70.0	92.0	10.0	10.0	LNM-0700-0920-1-1
70.0	95.0	9.0	18.0	LSM-0700-0950-1-1
70.0	95.0	9.0	18.0	LWM-0700-0950-1-1
70.0	95.0	10.0	10.0	LNM-0700-0950-1-1
70.0	96.0	9.0	18.0	LSM-0700-0960-1-1
70.0	96.0	10.0	10.0	LNM-0700-0960-1-1
70.0	100.0	9.0	18.0	LSM-0700-1000-1-1
70.0	100.0	10.0	10.0	LNM-0700-1000-1-1
70.0	103.0	9.0	18.0	LSM-0700-1030-1-1
70.0	105.0	9.0	18.0	LSM-0700-1050-1-1
70.0	108.0	10.0	10.0	LNM-0700-1080-1-1
70.0	110.0	8.0	17.0	FSM-0700-1100-1-1
70.0	110.0	9.0	18.0	LSM-0700-1100-1-1
70.0	110.0	10.0	10.0	LNM-0700-1100-1-1
70.5	90.0	9.0	18.0	LSM-0705-0900-1-1
72.0	95.0	9.0	18.0	LSM-0720-0950-1-1
72.0	95.0	10.0	10.0	LNM-0720-0950-1-1
72.0	98.0	9.0	18.0	LSM-0720-0980-1-1
72.0	100.0	9.0	18.0	LSM-0720-1000-1-1
73.0	95.2	9.0	18.0	LSM-0730-0952-1-1
73.0	98.4	8.0	17.0	FSM-0730-0984-1-1
73.0	99.0	9.0	18.0	LSM-0730-0990-1-1
73.0	101.7	10.0	10.0	LNM-0730-1017-1-1
74.0	110.0	9.0	18.0	LSM-0740-1100-1-1
74.6	95.2	9.0	18.0	LSM-0746-0952-1-1
75.0	90.0	9.0	18.0	LSM-0750-0900-1-1
75.0	90.0	9.0	18.0	LWM-0750-0900-1-1
75.0	90.0	10.0	10.0	LNM-0750-0900-1-1
75.0	95.0	9.0	18.0	LSM-0750-0950-1-1
75.0	95.0	9.0	18.0	LSM-0750-0950-1-1
75.0	95.0	9.0	18.0	LWM-0750-0950-1-1
75.0	95.0	10.0	10.0	LNM-0750-0950-1-1
75.0	97.0	9.0	18.0	LSM-0750-0970-1-1
75.0	100.0	8.0	17.0	FSM-0750-1000-1-1
75.0	100.0	9.0	18.0	LSM-0750-1000-1-1
75.0	100.0	9.0	18.0	LWM-0750-1000-1-1
75.0	100.0	10.0	10.0	LNM-0750-1000-1-1
75.0	100.0	15.0	15.0	FNM-0750-1000-1-1
75.0	101.0	8.0	17.0	FSM-0750-1010-1-1
75.0	101.0	9.0	18.0	LSM-0750-1010-1-1
75.0	105.0	9.0	18.0	LSM-0750-1050-1-1
75.0	105.0	10.0	10.0	LNM-0750-1050-1-1
75.0	106.0	9.0	18.0	LSM-0750-1060-1-1
75.0	108.0	10.0	10.0	LNM-0750-1080-1-1
75.0	109.0	9.0	18.0	LSM-0750-1090-1-1
75.0	110.0	9.0	18.0	LSM-0750-1100-1-1
75.0	110.0	10.0	10.0	LNM-0750-1100-1-1
76.0	100.0	10.0	10.0	LNM-0760-1000-1-1
76.2	107.9	9.0	18.0	LSM-0762-1079-1-1
77.0	95.0	9.0	18.0	LSM-0770-0950-1-1
78.0	98.0	10.0	10.0	LNM-0780-0980-1-1
78.0	100.0	9.0	18.0	LSM-0780-1000-1-1
78.0	100.0	10.0	10.0	LNM-0780-1000-1-1
78.0	110.0	9.0	18.0	FSM-0780-1100-1-1
79.0	100.0	9.0	18.0	LSM-0790-1000-1-1

See Section 4 for seal part number prefix description.

03/03/06



79.0 to 104.0

Shaft Dia.	Bore Dia.	Total In Bore Depth	Total Seal Width	ProTech Part Number
79.0	119.0	10.0	10.0	LNM-0790-1190-1-1
79.5	105.0	15.0	15.0	FNM-0795-1050-1-1
80.0	100.0	9.0	18.0	LSM-0800-1000-1-1
80.0	100.0	10.0	10.0	LNM-0800-1000-1-1
80.0	100.0	15.0	15.0	FNM-0800-1000-1-1
80.0	101.0	9.0	18.0	LSM-0800-1010-1-1
80.0	104.0	10.0	10.0	LNM-0800-1040-1-1
80.0	105.0	9.0	18.0	LSM-0800-1050-1-1
80.0	105.0	10.0	10.0	LNM-0800-1050-1-1
80.0	106.0	9.0	18.0	FSM-0800-1060-1-1
80.0	106.0	9.0	18.0	LSM-0800-1060-1-1
80.0	106.0	9.0	18.0	LWM-0800-1060-5-3
80.0	106.0	10.0	10.0	LNM-0800-1060-1-1
80.0	110.0	9.0	18.0	FSM-0800-1100-1-1
80.0	110.0	9.0	18.0	LSM-0800-1100-1-1
80.0	110.0	9.0	18.0	LWM-0800-1100-1-1
80.0	110.0	10.0	10.0	LNM-0800-1100-1-1
80.0	110.0	15.0	15.0	FNM-0800-1100-1-1
80.0	111.1	10.0	10.0	LNM-0800-1111-1-1
80.0	115.0	9.0	18.0	LSM-0800-1150-1-1
80.0	115.0	10.0	10.0	LNM-0800-1150-1-1
80.0	115.0	15.0	15.0	FNM-0800-1150-1-1
80.0	119.0	15.0	15.0	FNM-0800-1190-1-1
80.0	120.0	9.0	18.0	FSM-0800-1200-1-1
80.0	120.0	9.0	18.0	LSM-0800-1200-1-1
80.5	110.5	9.0	18.0	LSM-0805-1105-1-1
80.9	108.0	9.0	18.0	LSM-0809-1080-1-1
81.5	101.5	9.0	18.0	LSM-0815-1015-1-1
81.8	106.8	9.0	18.0	LSM-0818-1068-1-1
82.0	110.0	12.0	12.0	LNM-0820-1100-1-1
84.0	103.1	9.0	18.0	FSM-0840-1031-1-1
84.0	109.0	9.0	18.0	LWM-0840-1090-1-1
84.0	110.0	9.0	18.0	LSM-0840-1100-1-1
84.0	115.0	9.0	18.0	LSM-0840-1150-1-1
85.0	101.6	12.0	12.0	LNM-0850-1016-1-1
85.0	105.0	9.0	18.0	LSM-0850-1050-1-1
85.0	105.0	12.0	12.0	LNM-0850-1050-1-1
85.0	108.0	9.0	18.0	LSM-0850-1080-1-1
85.0	110.0	9.0	18.0	FSM-0850-1100-1-1
85.0	110.0	9.0	18.0	LSM-0850-1100-1-1
85.0	110.0	9.0	18.0	LWM-0850-1100-1-1
85.0	110.0	12.0	12.0	LNM-0850-1100-1-1
85.0	110.0	15.0	15.0	FNM-0850-1100-1-1
85.0	110.4	15.0	15.0	FNM-0850-1104-1-1
85.0	110.4	15.0	15.0	FNM-0850-1104-1-1
85.0	111.0	9.0	18.0	FSM-0850-1110-1-1
85.0	111.0	9.0	18.0	LSM-0850-1110-1-1
85.0	111.0	12.0	12.0	LNM-0850-1110-1-1
85.0	112.0	9.0	18.0	LSM-0850-1120-1-1
85.0	112.0	9.0	18.0	LWM-0850-1120-5-1
85.0	115.0	9.0	18.0	LSM-0850-1150-1-1
85.0	120.0	9.0	18.0	LSM-0850-1200-1-1
85.0	120.0	12.0	12.0	LNM-0850-1200-1-1
85.0	125.0	12.0	12.0	LNM-0850-1250-1-1
85.1	119.1	9.0	18.0	LSM-0851-1191-1-1
85.7	108.0	9.0	18.0	LSM-0857-1080-1-1
85.7	110.0	9.0	18.0	LSM-0857-1100-1-1
85.7	117.5	12.0	12.0	LNM-0857-1175-1-1
86.0	110.0	9.0	18.0	LSM-0860-1100-1-1
86.0	111.1	9.0	18.0	LSM-0860-1111-1-1
87.0	114.0	9.0	18.0	LSM-0870-1140-1-1
87.8	112.8	9.0	18.0	LSM-0878-1128-1-1
88.0	110.0	12.0	12.0	LNM-0880-1100-1-1
88.9	107.9	12.0	12.0	LNM-0889-1079-1-1
89.0	110.0	12.0	12.0	LNM-0890-1100-1-1
89.1	112.0	9.0	18.0	LSM-0891-1120-1-1

Shaft Dia.	Bore Dia.	Total In Bore Depth	Total Seal Width	ProTech Part Number
90.0	110.0	9.0	18.0	FSM-0900-1100-1-1
90.0	110.0	9.0	18.0	FSM-0900-1100-1-1
90.0	110.0	9.0	18.0	LSM-0900-1100-1-1
90.0	110.0	9.0	18.0	LWM-0900-1100-1-1
90.0	110.0	12.0	12.0	LNM-0900-1100-1-1
90.0	110.0	15.0	15.0	FNM-0900-1100-1-1
90.0	115.0	9.0	18.0	LSM-0900-1150-1-1
90.0	115.0	9.0	18.0	LWM-0900-1150-1-1
90.0	115.0	12.0	12.0	LNM-0900-1150-1-1
90.0	115.0	12.0	12.0	LNM-0900-1150-1-1
90.0	116.0	9.0	18.0	LSM-0900-1160-1-1
90.0	116.0	9.0	18.0	LSM-0900-1160-5-1
90.0	120.0	9.0	18.0	FSM-0900-1200-1-1
90.0	120.0	9.0	18.0	LSM-0900-1200-1-1
90.0	120.0	12.0	12.0	LNM-0900-1200-1-1
90.0	120.0	15.0	15.0	FNM-0900-1200-1-1
90.0	130.0	9.0	18.0	LSM-0900-1300-1-1
90.5	115.0	9.0	18.0	LSM-0905-1150-1-1
92.1	120.7	12.0	12.0	LNM-0921-1207-1-1
93.0	115.0	9.0	18.0	LSM-0930-1150-1-1
94.5	120.0	12.0	12.0	LNM-0945-1200-1-1
94.5	120.0	15.0	15.0	FNM-0945-1200-1-1
95.0	115.0	9.0	18.0	LSM-0950-1150-1-1
95.0	115.0	12.0	12.0	LNM-0950-1150-1-1
95.0	118.0	9.0	18.0	LSM-0950-1180-1-1
95.0	120.0	9.0	18.0	FSM-0950-1200-1-1
95.0	120.0	9.0	18.0	LSM-0950-1200-1-1
95.0	120.0	12.0	12.0	LNM-0950-1200-1-1
95.0	120.0	12.0	12.0	LNM-0950-1200-5-1
95.0	120.3	9.0	18.0	LSM-0950-1203-5-1
95.0	121.0	9.0	18.0	LSM-0950-1210-1-1
95.0	125.0	9.0	18.0	LSM-0950-1250-1-1
95.0	125.0	12.0	12.0	LNM-0950-1250-1-1
95.0	125.0	15.0	15.0	FNM-0950-1250-1-1
95.0	130.0	12.0	12.0	LNM-0950-1300-1-1
96.0	122.0	9.0	18.0	LSM-0960-1220-1-1
96.7	130.0	9.0	18.0	LSM-0967-1300-1-1
97.0	114.3	12.0	12.0	LNM-0970-1143-1-1
97.0	118.0	9.0	18.0	LSM-0970-1180-1-1
97.0	125.0	12.0	12.0	LNM-0970-1250-1-1
99.0	126.0	9.0	18.0	LSM-0990-1260-1-1
99.5	120.0	12.0	12.0	LNM-0995-1200-1-1
100.0	116.0	9.0	18.0	LSM-1000-1160-1-1
100.0	120.0	9.0	18.0	FSM-1000-1200-5-1
100.0	120.0	9.0	18.0	FSM-1000-1200-5-1
100.0	120.0	9.0	18.0	LSM-1000-1200-1-1
100.0	120.0	9.0	18.0	LSM-1000-1200-5-1
100.0	120.0	12.0	12.0	LNM-1000-1200-1-1
100.0	125.0	9.0	18.0	LSM-1000-1250-1-1
100.0	125.0	9.0	18.0	LSM-1000-1250-5-1
100.0	125.0	12.0	12.0	LNM-1000-1250-1-1
100.0	125.4	9.0	18.0	LSM-1000-1254-1-1
100.0	126.0	9.0	18.0	LSM-1000-1260-1-1
100.0	126.0	15.0	15.0	FNM-1000-1260-1-1
100.0	130.0	9.0	18.0	FSM-1000-1300-1-1
100.0	130.0	9.0	18.0	FSM-1000-1300-5-1
100.0	130.0	9.0	18.0	LSM-1000-1300-1-1
100.0	130.0	12.0	12.0	LNM-1000-1300-1-1
100.0	135.0	9.0	18.0	LSM-1000-1350-1-1
100.0	135.0	12.0	12.0	LNM-1000-1350-1-1
100.0	136.5	12.0	12.0	LNM-1000-1365-1-1
101.4	127.0	9.0	18.0	LSM-1014-1270-1-1
101.4	127.0	9.0	18.0	LSM-1014-1270-5-1
102.0	137.0	12.0	12.0	LNM-1020-1370-5-1
104.0	129.0	9.0	18.0	LSM-1040-1290-5-1



03/03/06

See Section 4 for seal part number prefix description.



Shaft Dia.	Bore Dia.	Total In Bore Depth	Total Seal Width	ProTech Part Number
104.0	142.0	9.0	18.0	LSM-1040-1420-6-1
105.0	130.0	9.0	18.0	FSM-1050-1300-5-1
105.0	130.0	9.0	18.0	LSM-1050-1300-5-1
105.0	130.0	12.0	12.0	LNM-1050-1300-5-1
105.0	131.0	9.0	18.0	LSM-1050-1310-5-1
105.0	135.0	9.0	18.0	LSM-1050-1350-5-1
105.0	137.0	12.0	12.0	LNM-1050-1370-5-1
105.0	140.0	9.0	18.0	LSM-1050-1400-5-1
105.0	140.0	12.0	12.0	LNM-1050-1400-5-1
105.5	130.0	9.0	18.0	LSM-1055-1300-5-1
110.0	130.0	9.0	18.0	LSM-1100-1300-5-1
110.0	130.0	9.0	18.0	LWM-1100-1300-5-1
110.0	130.0	12.0	12.0	LNM-1100-1300-5-1
110.0	135.0	9.0	18.0	LSM-1100-1350-5-1
110.0	136.0	9.0	18.0	LSM-1100-1360-1-1
110.0	136.0	9.0	18.0	LSM-1100-1360-5-1
110.0	140.0	9.0	18.0	FSM-1100-1400-5-1
110.0	140.0	9.0	18.0	LSM-1100-1400-5-1
110.0	140.0	12.0	12.0	LNM-1100-1400-5-1
110.0	141.0	9.0	18.0	LSM-1100-1410-5-1
110.0	142.0	9.0	18.0	LSM-1100-1420-6-1
110.0	145.0	12.0	12.0	LNM-1100-1450-5-1
110.0	149.4	12.0	12.0	LNM-1100-1494-5-1
110.0	150.0	12.0	12.0	LNM-1100-1500-5-1
111.0	145.0	9.0	18.0	LSM-1110-1450-5-1
114.0	134.0	9.0	18.0	FSM-1140-1340-5-1
114.0	140.0	9.0	18.0	FSM-1140-1400-5-1
114.3	150.0	9.0	18.0	LSM-1143-1500-5-1
115.0	140.0	9.0	18.0	LSM-1150-1400-4-1
115.0	140.0	9.0	18.0	LSM-1150-1400-5-1
115.0	140.0	12.0	12.0	LNM-1150-1400-5-1
115.0	141.0	9.0	18.0	LSM-1150-1410-5-1
115.0	145.0	9.0	18.0	LSM-1150-1450-5-1
115.0	145.0	12.0	12.0	LNM-1150-1450-5-1
115.0	155.0	9.0	18.0	LSM-1150-1550-5-1
117.2	143.2	9.0	18.0	LSM-1172-1432-5-1
117.5	146.0	12.0	12.0	LNM-1175-1460-5-1
118.0	150.0	9.0	18.0	LSM-1180-1500-5-1
118.0	150.0	12.0	12.0	LNM-1180-1500-5-1
119.9	142.2	9.0	18.0	LSM-1199-1422-5-1
120.0	140.0	9.0	18.0	FSM-1200-1400-5-1
120.0	140.0	9.0	18.0	FSM-1200-1400-5-5
120.0	142.0	9.0	18.0	LSM-1200-1420-5-1
120.0	145.0	9.0	18.0	LSM-1200-1450-5-1
120.0	146.0	9.0	18.0	LSM-1200-1460-5-1
120.0	148.0	12.0	12.0	LNM-1200-1480-5-1
120.0	150.0	9.0	18.0	FSM-1200-1500-5-1
120.0	150.0	9.0	18.0	LSM-1200-1500-5-1
120.0	150.0	12.0	12.0	LNM-1200-1500-4-1
120.0	150.0	12.0	12.0	LNM-1200-1500-5-1
120.0	160.0	9.0	18.0	FSM-1200-1600-5-1
120.0	160.0	9.0	18.0	LSM-1200-1600-5-1
120.0	180.0	12.0	12.0	LNM-1200-1800-5-1
122.0	148.0	9.0	18.0	LSM-1220-1480-5-1

Shaft Dia.	Bore Dia.	Total In Bore Depth	Total Seal Width	ProTech Part Number
124.0	150.0	9.0	18.0	LSM-1240-1500-5-1
124.0	160.0	9.0	18.0	LSM-1240-1600-5-1
125.0	150.0	9.0	18.0	LSM-1250-1500-5-1
125.0	150.0	9.0	18.0	LWM-1250-1500-5-1
125.0	150.0	12.0	12.0	LNM-1250-1500-5-1
125.0	151.0	9.0	18.0	LSM-1250-1510-5-1
125.0	155.0	12.0	12.0	LNM-1250-1550-5-1
125.4	152.4	9.0	18.0	LSM-1254-1524-5-1
126.0	160.2	9.0	18.0	LSM-1260-1602-5-1
127.0	150.0	9.0	18.0	LSM-1270-1500-5-1
129.0	152.0	9.0	18.0	LSM-1290-1520-5-1
130.0	150.0	12.0	12.0	LNM-1300-1500-5-1
130.0	155.0	9.0	18.0	LSM-1300-1550-5-1
130.0	155.0	12.0	12.0	LNM-1300-1550-5-1
130.0	156.0	9.0	18.0	FSM-1300-1560-5-1
130.0	156.0	9.0	18.0	FSM-1300-1560-5-1
130.0	156.0	9.0	18.0	LSM-1300-1560-5-1
130.0	156.0	9.0	18.0	LSM-1300-1560-5-1
130.0	156.0	12.0	12.0	LNM-1300-1560-5-1
130.0	160.0	9.0	18.0	FSM-1300-1600-5-1
130.0	160.0	9.0	18.0	LSM-1300-1600-5-1
130.0	160.0	9.0	18.0	LWM-1300-1600-5-1
130.0	160.0	12.0	12.0	LNM-1300-1600-5-1
130.0	170.0	9.0	18.0	LSM-1300-1700-5-1
135.0	165.0	15.0	15.0	LNM-1350-1650-5-1
135.0	170.0	9.0	18.0	FSM-1350-1700-5-1
135.0	170.0	15.0	15.0	LNM-1350-1700-5-1
135.0	175.0	15.0	15.0	LNM-1350-1750-5-1
140.0	170.0	9.0	18.0	FSM-1400-1700-5-1
140.0	170.0	15.0	15.0	LNM-1400-1700-5-1
140.0	180.0	9.0	18.0	FSM-1400-1800-5-1
145.0	170.0	15.0	15.0	LNM-1450-1700-5-1
145.0	180.0	15.0	15.0	LNM-1450-1800-5-1
146.0	184.0	15.0	15.0	LNM-1460-1840-5-1
150.0	180.0	9.0	18.0	FSM-1500-1800-5-1
150.0	180.0	15.0	15.0	LNM-1500-1800-5-1
150.0	182.0	15.0	15.0	LNM-1500-1820-5-1
155.0	180.0	15.0	15.0	LNM-1550-1800-5-1
158.8	190.0	15.0	15.0	LNM-1588-1900-5-1
160.0	190.0	15.0	15.0	LNM-1600-1900-5-1
161.2	187.5	15.0	15.0	LNM-1612-1875-5-1
165.0	200.0	15.0	15.0	LNM-1650-2000-5-1
170.0	200.0	15.0	15.0	LNM-1700-2000-5-1
177.8	216.1	15.0	15.0	LNM-1778-2161-5-1
180.0	220.0	15.0	15.0	LNM-1800-2200-5-1
185.0	210.0	15.0	15.0	LNM-1850-2100-5-1
190.0	220.0	15.0	15.0	LNM-1900-2200-5-1
190.0	225.0	15.0	15.0	LNM-1900-2250-5-1
190.5	220.0	15.0	15.0	LNM-1905-2200-5-1
200.0	230.0	15.0	15.0	LNM-2000-2300-5-1
200.0	240.0	15.0	15.0	LNM-2000-2400-5-1
210.0	240.0	15.0	15.0	LNM-2100-2400-5-1
220.0	250.0	15.0	15.0	LNM-2200-2500-5-1

F

See **Section 4** for seal part number prefix description.

03/03/06



Fractional/Decimal/Metric Conversion

Catalog EPS 5350/USA

Fractional	Decimal	Metric
—	0.004	0.10
—	0.010	0.25
1/64	0.016	0.40
—	0.020	0.50
—	0.030	0.75
1/32	0.031	0.79
—	0.039	1.00
3/64	0.047	1.19
—	0.059	1.50
1/16	0.063	1.59
5/64	0.078	1.98
—	0.079	2.00
3/32	0.094	2.38
—	0.098	2.50
7/64	0.109	2.78
—	0.118	3.00
1/8	0.125	3.18
—	0.138	3.50
9/64	0.141	3.57
5/32	0.156	3.97
—	0.158	4.00
11/64	0.172	4.37
—	0.177	4.50
3/16	0.188	4.76
—	0.197	5.00
13/64	0.203	5.16
—	0.217	5.50
7/32	0.219	5.56
15/64	0.234	5.95
—	0.236	6.00
1/4	0.250	6.35
—	0.256	6.50
17/64	0.266	6.75
—	0.276	7.00
9/32	0.281	7.14
—	0.295	7.50
19/64	0.297	7.54
5/16	0.313	7.94
—	0.315	8.00
21/64	0.328	8.33
—	0.335	8.50
11/32	0.344	8.73
—	0.354	9.00
23/64	0.359	9.13
—	0.374	9.50
3/8	0.375	9.53
25/64	0.391	9.92
—	0.394	10.00
12/32	0.406	10.32
—	0.413	10.50
27/64	0.422	10.72
—	0.433	11.00
7/16	0.438	11.11
29/64	0.453	11.51
15/32	0.469	11.91
—	0.472	12.00
31/64	0.484	12.30
—	0.492	12.50
1/2	0.500	12.70
—	0.512	13.00
33/64	0.516	13.10
17/32	0.531	13.50
35/64	0.547	13.90
—	0.551	14.00
9/16	0.563	14.29
—	0.571	14.50

Fractional	Decimal	Metric
37/64	0.578	14.68
—	0.591	15.00
19/32	0.594	15.08
39/64	0.609	15.48
5/8	0.625	15.88
—	0.630	16.00
41/64	0.641	16.27
—	0.650	16.50
21/32	0.656	16.67
—	0.669	17.00
43/64	0.672	17.01
11/16	0.688	17.46
45/64	0.703	17.86
—	0.709	18.00
23/32	0.719	18.26
—	0.728	18.49
47/64	0.734	18.65
—	0.748	19.00
3/4	0.750	19.05
49/64	0.766	19.45
25/32	0.781	19.84
—	0.787	20.00
51/64	0.797	20.24
13/16	0.813	20.64
—	0.827	21.00
53/64	0.828	21.03
27/32	0.844	21.43
55/64	0.859	21.83
—	0.866	22.00
7/8	0.875	22.23
57/64	0.891	22.62
—	0.906	23.00
29/32	0.906	23.02
59/64	0.922	23.42
15/16	0.938	23.81
—	0.945	24.00
61/64	0.953	24.21
31/32	0.969	24.61
—	0.984	25.00
1	1.000	25.40
—	1.024	26.00
1 1/32	1.031	26.19
1 1/16	1.062	26.99
—	1.063	27.00
1 3/32	1.094	27.78
—	1.102	28.00
1 1/8	1.125	28.58
—	1.148	29.00
1 5/32	1.156	29.37
—	1.181	30.00
1 3/16	1.188	30.16
1 7/32	1.219	30.96
—	1.221	31.00
1 1/4	1.250	31.75
—	1.260	32.00
1 9/32	1.281	32.54
—	1.299	33.00
1 5/16	1.312	33.34
—	1.339	34.00
1 11/32	1.344	34.13
1 3/8	1.375	34.93
—	1.378	35.00
1 13/32	1.406	35.72
—	1.417	36.00
1 7/16	1.438	36.51
—	1.457	37.00

Fractional	Decimal	Metric
1 15/32	1.469	37.31
—	1.496	38.00
1 1/2	1.500	38.10
1 17/32	1.531	38.89
—	1.535	39.00
1 9/16	1.562	39.69
—	1.575	40.00
1 19/64	1.594	40.48
—	1.614	41.00
1 5/8	1.625	41.28
—	1.654	42.00
1 21/32	1.656	42.07
1 11/16	1.688	42.86
—	1.693	43.00
1 23/32	1.719	43.66
—	1.732	44.00
1 3/4	1.750	44.50
—	1.772	45.00
1 25/32	1.781	45.24
—	1.811	46.00
1 13/16	1.813	46.04
1 27/32	1.844	46.83
—	1.850	47.00
1 7/8	1.875	47.63
—	1.890	48.00
1 29/32	1.906	48.42
—	1.929	49.00
1 15/16	1.938	49.21
—	1.970	50.00
1 31/32	1.970	50.01
2	2.000	50.80
—	2.008	51.00
—	2.047	52.00
2 1/16	2.062	52.39
—	2.087	53.00
2 1/8	2.125	53.98
—	2.126	54.00
—	2.165	55.00
2 3/16	2.188	55.56
—	2.205	56.00
—	2.244	57.00
2 1/4	2.250	57.15
—	2.284	58.00
2 5/16	2.312	58.74
—	2.323	59.00
—	2.362	60.00
2 3/8	2.375	60.33
—	2.402	61.00
2 7/16	2.438	61.91
—	2.441	62.00
—	2.480	63.00
2 1/2	2.500	63.50
—	2.520	64.00
—	2.559	65.00
2 9/16	2.562	65.09
—	2.598	66.00
2 5/8	2.625	66.68
—	2.638	67.00
—	2.677	68.00
2 11/16	2.688	68.26
—	2.717	69.00
2 3/4	2.750	69.85
—	2.756	70.00
—	2.795	71.00
2 13/16	2.813	71.44
—	2.835	72.00

Fractional	Decimal	Metric
—	2.874	73.00
2 7/8	2.875	73.03
—	2.913	74.00
2 15/16	2.938	74.61
—	2.953	75.00
—	2.992	76.00
3	3.000	76.20
—	3.032	77.00
3 1/16	3.062	77.79
—	3.071	78.00
—	3.110	79.00
3 1/8	3.125	79.38
—	3.150	80.00
3 3/16	3.188	80.96
—	3.189	81.00
—	3.228	82.00
3 1/4	3.250	82.55
—	3.268	83.00
—	3.307	84.00
3 5/16	3.312	84.14
—	3.346	85.00
3 3/8	3.375	85.73
—	3.386	86.00
—	3.425	87.00
3 7/16	3.438	87.31
—	3.465	88.00
3 1/2	3.500	88.90
—	3.504	89.00
—	3.543	90.00
3 9/16	3.562	90.49
—	3.583	91.00
—	3.622	92.00
3 5/8	3.625	92.08
—	3.661	93.00
3 11/16	3.688	93.66
—	3.701	94.00
—	3.740	95.00
3 3/4	3.750	95.25
—	3.780	96.00
3 13/16	3.813	96.84
—	3.819	97.00
—	3.858	98.00
3 7/8	3.875	98.43
—	3.898	99.00
—	3.937	100.00
3 15/16	3.938	100.01
—	3.976	101.00
4	4.000	101.60
4 1/16	4.062	103.19
4 1/8	4.125	104.78
—	4.134	105.00
4 3/16	4.188	106.36
4 1/4	4.250	107.95
4 5/16	4.312	109.54
—	4.331	110.00
4 3/8	4.375	111.13
4 7/16	4.438	112.71
4 1/2	4.500	114.30
—	4.528	115.00
4 9/16	4.562	115.89
4 5/8	4.625	117.48
—	4.724	120.00
4 3/4	4.750	120.65
4 7/8	4.875	123.83
—	4.921	125.00
5	5.000	127.00

03/03/06



RPM to FPM Conversion

Catalog EPS 5350/USA

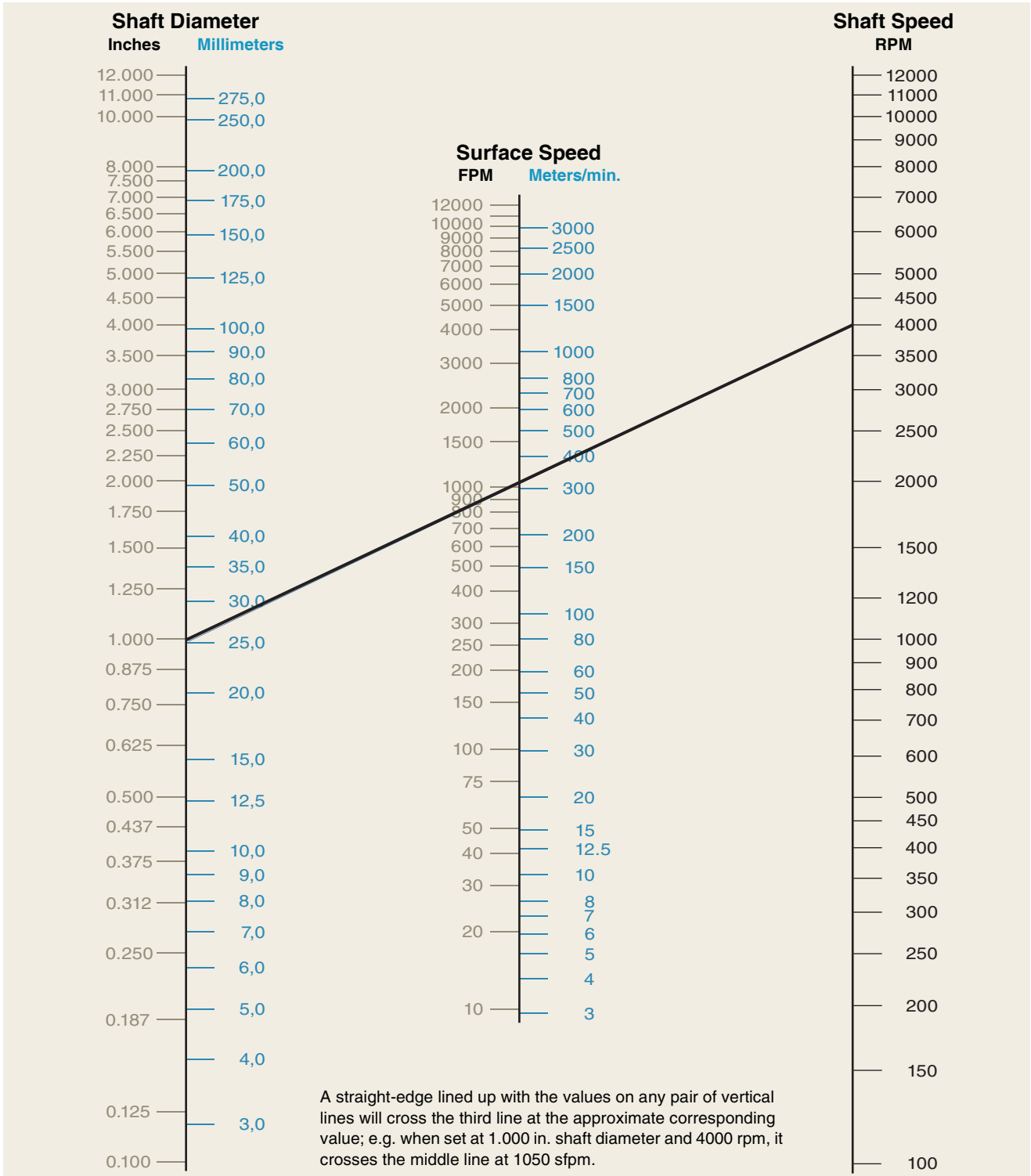

03/03/06



Temperature Conversion

Catalog EPS 5350/USA

Celsius	Fahrenheit
-169	-273
-168	-270
-162	-260
-157	-250
-151	-240
-146	-230
-140	-220
-134	-210
-129	-200
-123	-190
-118	-180
-112	-170
-107	-160
-101	-150
-96	-140
-90	-130
-84	-120
-79	-110
-73	-100
-68	-90
-62	-80
-57	-70
-51	-60
-46	-50
-40	-40
-34	-30
-29	-20
-23	-10
-17.8	0
-17.2	1
-16.7	2
-16.1	3
-15.6	4
-15	5
-14.4	6
-13.9	7
-13.3	8
-12.8	9
-12.2	10
-11.7	11
-11.1	12
-10.6	13
-10	14
-9.4	15
-8.9	16
-8.3	17

Celsius	Fahrenheit
-7.8	18
-7.2	19
-6.7	20
-6.1	21
-5.6	22
-5	23
-4.4	24
-3.9	25
-3.3	26
-2.8	27
-2.2	28
-1.7	29
-1.1	30
-0.6	31
0	32
0.6	33
1.1	34
1.7	35
2.2	36
2.8	37
3.3	38
3.9	39
4.4	40
5	41
5.6	42
6.1	43
6.7	44
7.2	45
7.8	46
8.3	47
8.9	48
9.4	49
10	50
10.6	51
11.1	52
11.7	53
12.2	54
12.8	55
13.3	56
13.9	57
14.4	58
15	59
15.6	60
16.1	61
16.7	62
17.2	63

Celsius	Fahrenheit
17.8	64
18.3	65
18.9	66
19.4	67
20	68
20.6	69
21.1	70
21.7	71
22.2	72
22.8	73
23.3	74
23.9	75
24.4	76
25	77
25.6	78
26.1	79
26.7	80
27.2	81
27.8	82
28.3	83
28.9	84
29.4	85
30	86
30.6	87
31.1	88
31.7	89
32.2	90
32.8	91
33.3	92
33.9	93
34.4	94
35	95
35.6	96
36.1	97
36.7	98
37.2	99
37.8	100
43	110
49	120
54	130
60	140
66	150
71	160
77	170
82	180
88	190

Celsius	Fahrenheit
93	200
99	210
100	212
104	220
110	230
116	240
121	250
127	260
132	270
138	280
143	290
149	300
154	310
160	320
166	330
171	340
177	350
182	360
188	370
193	380
199	390
204	400
210	410
216	420
221	430
227	440
232	450
238	460
243	470
249	480
254	490
260	500
266	510
271	520
277	530
282	540
288	550
293	560
299	570
304	580
310	590
316	600
321	610
327	620
332	630
338	640

Celsius	Fahrenheit
343	650
349	660
354	670
360	680
366	690
371	700
377	710
382	720
388	730
393	740
399	750
404	760
410	770
416	780
421	790
427	800
432	810
438	820
443	830
449	840
454	850
460	860
466	870
471	880
477	890
482	900
488	910
493	920
499	930
504	940
510	950
516	960
521	970
527	980
532	990
538	1000
549	1020
560	1040
571	1060
582	1080
593	1100
604	1120
616	1140
627	1160
638	1180
649	1200



03/03/06



Pressure Conversion — PSI / BAR

Catalog EPS 5350/USA

1-40		41-80		81-200		205-500		510-900		910-1500	
psi	bar	psi	bar	psi	bar	psi	bar	psi	bar	psi	bar
1	0.07	41	2.83	81	5.59	205	14.13	510	35.17	910	62.76
2	0.14	42	2.90	82	5.65	210	14.48	520	35.86	920	63.45
3	0.21	43	2.97	83	5.72	215	14.82	530	36.55	930	64.14
4	0.28	44	3.03	84	5.79	220	15.17	540	37.24	940	64.83
5	0.34	45	3.10	85	5.86	225	15.51	550	37.92	950	65.52
6	0.41	46	3.17	86	5.93	230	15.86	560	38.62	960	66.21
7	0.48	47	3.24	87	6.00	235	16.20	570	39.31	970	66.90
8	0.55	48	3.31	88	6.07	240	16.55	580	40.00	980	67.59
9	0.62	49	3.38	89	6.14	245	16.89	590	40.69	990	68.28
10	0.69	50	3.45	90	6.21	250	17.24	600	41.37	1000	68.95
11	0.76	51	3.52	91	6.27	255	17.58	610	42.07	1010	69.66
12	0.83	52	3.59	92	6.34	260	17.93	620	42.76	1020	70.34
13	0.90	53	3.65	93	6.41	265	18.27	630	43.45	1030	71.03
14	0.97	54	3.72	94	6.48	270	18.62	640	44.14	1040	71.72
15	1.03	55	3.79	95	6.55	275	18.96	650	44.82	1050	72.41
16	1.10	56	3.86	96	6.62	280	19.31	660	45.52	1060	73.10
17	1.17	57	3.93	97	6.69	285	19.65	670	46.21	1070	73.79
18	1.24	58	4.00	98	6.76	290	20.00	680	46.90	1080	74.48
19	1.31	59	4.07	99	6.83	295	20.34	690	47.59	1090	75.17
20	1.38	60	4.14	100	6.90	300	20.69	700	48.27	1100	75.86
21	1.45	61	4.21	105	7.24	310	21.37	710	48.97	1120	77.24
22	1.52	62	4.28	110	7.58	320	22.06	720	49.66	1140	78.62
23	1.59	63	4.34	115	7.93	330	22.75	730	50.34	1160	80.00
24	1.65	64	4.41	120	8.27	340	23.44	740	51.03	1180	81.38
25	1.72	65	4.48	125	8.62	350	24.13	750	51.71	1200	82.76
26	1.79	66	4.55	130	8.89	360	24.82	760	52.41	1220	84.14
27	1.86	67	4.62	135	9.31	370	25.51	770	53.10	1240	85.52
28	1.93	68	4.69	140	9.65	380	26.21	780	53.79	1260	86.90
29	2.00	69	4.76	145	10.10	390	26.89	790	54.48	1280	88.28
30	2.07	70	4.83	150	10.34	400	27.85	800	55.16	1300	89.66
31	2.14	71	4.90	155	10.69	410	28.27	810	55.86	1320	91.03
32	2.21	72	4.97	160	11.03	420	28.96	820	56.55	1340	92.41
33	2.28	73	5.03	165	11.38	430	29.65	830	57.24	1360	93.79
34	2.34	74	5.10	170	11.72	440	30.34	840	57.93	1380	95.17
35	2.41	75	5.17	175	12.07	450	31.03	850	58.61	1400	96.55
36	2.48	76	5.24	180	12.41	460	31.72	860	59.31	1420	97.93
37	2.55	77	5.31	185	12.76	470	32.41	870	60.00	1440	99.31
38	2.62	78	5.38	190	13.10	480	33.10	880	60.69	1460	100.69
39	2.69	79	5.45	195	13.45	490	33.79	890	61.38	1480	102.07
40	2.76	80	5.52	200	13.79	500	34.48	900	62.06	1500	103.45

03/03/06



Chemical Compatibility

Catalog EPS 5350/USA

This information is provided for reference only. Always test under actual conditions.

COMPOUND COMPATIBILITY RATING 1 — Satisfactory 2 — Fair (usually OK for static seal) 3 — Doubtful (sometimes OK for static seal) 4 — Unsatisfactory X — Insufficient Data	Nitrile NBR	Hydrogenated Nitrile HNBR	Ethylene Propylene EPDM	Fluorocarbon FKM	Neoprene/Chloroprene CR	Polyacrylate ACM	Silicone MQ, VMQ, PVMQ
A							
Acetaldehyde	3	3	2	4	3	4	2
Acetamide	1	1	1	3	1	4	2
Acetanilide	3	3	1	3	1	4	2
Acetic Acid, 30%	X	X	1	X	X	X	X
Acetic Acid, 5%	2	2	1	1	1	4	1
Acetic Acid, Glacial	2	2	1	2	4	4	1
Acetic Acid, Hot, High Pressure	4	4	3	4	4	4	3
Acetic Anhydride	3	4	2	4	2	4	2
Acetoacetic Acid	3	3	1	3	1	4	2
Acetone	4	4	1	4	4	4	4
Acetone Cyanohydrin	3	3	1	3	1	4	2
Acetonitrile	3	X	1	1	X	X	X
Acetophenetidine	2	2	4	1	4	4	X
Acetophenone	4	4	1	4	4	4	4
Acetotoluidide	2	2	4	1	4	4	X
Acetyl Acetone	4	4	1	4	4	4	4
Acetyl Bromide	4	4	1	1	4	4	4
Acetyl Chloride	4	4	4	1	4	4	4
Acetylene	1	1	1	1	2	4	2
Acetylene Tetrabromide	4	4	1	1	2	X	X
Acetylene Tetrachloride	4	4	1	1	2	X	X
Acetylsalicylic Acid	2	2	4	1	4	4	X
Acrolein	3	3	1	3	1	4	2
Acrylic Acid	2	2	4	1	4	4	X
Acrylonitrile	4	4	4	3	4	4	4
Adipic Acid	1	1	2	X	X	X	X
Aero Lubriplate	1	1	4	1	1	1	2
Aero Shell 17 Grease	1	1	4	1	2	1	2
Aero Shell 750	2	2	4	1	4	2	4
Aero Shell 7A Grease	2	2	4	1	2	1	2
Aero Shell IAC	1	1	4	1	2	1	2
Aerosafe 2300	4	4	1	4	4	4	3
Aerosafe 2300W	4	4	1	4	4	4	3
Aerozene 50 (50% Hydrazine 50% UDMH)	3	3	1	4	4	X	4
Air, Below 200 °F	2	2	1	1	1	1	1
Air, 200 – 300 °F	3	3	2	1	2	2	1
Air, 300 – 400 °F	4	4	4	1	4	4	1
Air, 400 – 500 °F	4	4	4	3	4	4	2
Aliphatic Dicarboxylic Acid	2	2	4	1	4	4	X
Alkanes (Paraffin Hydrocarbons)	1	1	4	1	2	1	2
Alkanesulfonic Acid	1	1	4	1	2	1	2
Alkazene	4	4	4	2	4	4	4
Alkenes (Olefin Hydrocarbons)	2	2	4	1	4	4	X
Alkyl Acetone	3	3	1	3	1	4	2
Alkyl Alcohol	1	1	4	1	2	1	2
Alkyl Amine	1	1	4	1	2	1	2
Alkyl Aryl Sulfonates	1	1	4	1	2	1	2
Alkyl Aryl Sulfonics	1	1	4	1	2	1	2
Alkyl Benzene	2	2	4	1	4	4	X

COMPOUND COMPATIBILITY RATING 1 — Satisfactory 2 — Fair (usually OK for static seal) 3 — Doubtful (sometimes OK for static seal) 4 — Unsatisfactory X — Insufficient Data	Nitrile NBR	Hydrogenated Nitrile HNBR	Ethylene Propylene EPDM	Fluorocarbon FKM	Neoprene/Chloroprene CR	Polyacrylate ACM	Silicone MQ, VMQ, PVMQ
Alkyl Chloride	2	2	4	1	4	4	X
Alkyl Sulfide*	2	2	4	1	4	4	X
Alkylnaphthalene Sulfonic Acid	1	1	4	1	2	1	2
Allyl Chloride	2	2	4	1	1	X	X
Allylidene Diacetate	3	3	1	3	1	4	2
Alpha Picoline	3	3	1	3	1	4	2
Aluminum Acetate	2	2	1	4	2	4	4
Aluminum Bromide	1	1	1	1	1	1	1
Aluminum Chlorate	3	3	1	3	1	4	2
Aluminum Chloride	1	1	1	1	1	1	2
Aluminum Fluoride	1	1	1	1	1	X	2
Aluminum Formate	3	3	1	3	1	4	2
Aluminum Hydroxide	2	X	1	2	X	X	2
Aluminum Linoleate	1	1	4	1	2	1	2
Aluminum Nitrate	1	1	1	1	1	X	2
Aluminum Oxalate	3	3	1	3	1	4	2
Aluminum Phosphate	1	1	1	1	1	X	2
Aluminum Potassium Sulfate	3	3	1	3	1	4	2
Aluminum Salts	1	1	1	1	1	1	1
Aluminum Sodium Sulfate	3	3	1	3	1	4	2
Aluminum Sulfate	1	1	1	1	1	4	1
Alums-NH ₃ -Cr-K	1	1	1	4	1	4	1
Ambrex 33 (Mobil)	1	1	4	1	2	1	4
Ambrex 830 (Mobil)	1	1	3	1	2	1	2
Amines-Mixed	4	4	2	4	2	4	2
Ammonia (Anhydrous)	2	2	1	4	1	4	2
Ammonia and Lithium Metal in Solution	2	2	4	4	X	4	4
Ammonia, Gas, Cold	1	1	1	4	1	4	1
Ammonia, Gas, Hot	4	4	2	4	2	4	X
Ammonia, Liquid (Anhydrous)	2	2	1	4	1	4	2
Ammonium Acetate	3	3	1	3	1	4	2
Ammonium Arsenate	3	3	1	3	1	4	2
Ammonium Benzoate	3	3	1	3	1	4	2
Ammonium Bicarbonate	3	3	1	3	1	4	2
Ammonium Bisulfite	3	3	1	3	1	4	2
Ammonium Bromide	1	1	1	1	1	X	X
Ammonium Carbamate	3	3	1	3	1	4	2
Ammonium Carbonate	4	4	1	1	1	4	X
Ammonium Chloride, 2N	1	1	1	1	1	X	X
Ammonium Citrate	3	3	1	3	1	4	2
Ammonium Dichromate	3	3	1	3	1	4	2
Ammonium Diphosphate	3	3	1	3	1	4	2
Ammonium Fluoride	1	1	1	1	1	X	X
Ammonium Formate	3	3	1	3	1	4	2
Ammonium Hydroxide, 3 Molar	1	1	1	3	1	4	1
Ammonium Hydroxide, Concentrated	4	4	1	4	1	4	1
Ammonium Iodide	1	1	1	1	1	X	X
Ammonium Lactate	3	3	1	3	1	4	2
Ammonium Metaphosphate	3	3	1	3	1	4	2
Ammonium Molybdenate*	3	3	1	3	1	4	2



03/03/06



Chemical Compatibility

COMPOUND COMPATIBILITY RATING 1 — Satisfactory 2 — Fair (usually OK for static seal) 3 — Doubtful (sometimes OK for static seal) 4 — Unsatisfactory X — Insufficient Data							
	Nitrile NBR	Hydrogenated Nitrile HNBR	Ethylene Propylene EPDM	Fluorocarbon FKM	Neoprene/Chloroprene CR	Polyacrylate ACM	Silicone MQ, VMQ, PVMQ
Ammonium Nitrate, 2N	1	1	1	X	1	2	X
Ammonium Nitrite	1	1	1	X	1	X	2
Ammonium Oxalate	3	3	1	3	1	4	2
Ammonium Perchlorate	3	3	1	3	1	4	2
Ammonium Persulfate 10%	4	4	1	X	1	4	X
Ammonium Persulfate Solution	4	4	1	X	X	4	X
Ammonium Phosphate	1	1	1	4	1	X	1
Ammonium Phosphate, Dibasic	1	1	1	X	1	X	1
Ammonium Phosphate, Mono-Basic	1	1	1	X	1	X	1
Ammonium Phosphate, Tribasic	1	1	1	X	1	X	1
Ammonium Phosphite	3	3	1	3	1	4	2
Ammonium Picrate	3	3	1	3	1	4	2
Ammonium Polysulfide	3	3	1	3	1	4	2
Ammonium Salicylate	3	3	1	3	1	4	2
Ammonium Salts	1	1	1	3	1	3	1
Ammonium Sulfamate	3	3	1	3	1	4	2
Ammonium Sulfate	1	1	1	4	1	4	X
Ammonium Sulfate Nitrate	1	1	1	4	1	4	X
Ammonium Sulfide	1	1	1	4	1	4	X
Ammonium Sulfite	3	3	1	3	1	4	2
Ammonium Thiocyanate	3	3	1	3	1	4	2
Ammonium Thioglycolate	3	3	1	3	1	4	2
Ammonium Thiosulfate	3	3	1	3	1	4	2
Ammonium Tungstate	3	3	1	3	1	4	2
Ammonium Valerate	3	3	1	3	1	4	2
Amyl Acetate	1	1	3	4	4	4	4
Amyl Alcohol	2	2	1	2	2	4	4
Amyl Borate	1	1	4	1	1	X	X
Amyl Butyrate	1	1	4	1	2	1	2
Amyl Chloride	X	X	4	1	4	4	4
Amyl Chloronaphthalene	4	4	4	1	4	4	4
Amyl Cinnamic Aldehyde	2	2	4	1	4	4	X
Amyl Laurate	2	2	4	1	4	4	X
Amyl Mercaptan	2	2	4	1	4	4	X
Amyl Naphthalene	4	4	4	1	4	2	4
Amyl Nitrate	3	3	1	3	1	4	2
Amyl Nitrite	3	3	1	3	1	4	2
Amyl Propionate	1	1	4	1	2	1	2
Anderol, L- 826 (di-ester)	2	2	4	1	4	2	4
Anderol, L- 829 (di-ester)	2	2	4	1	4	2	4
Anderol, L-774 (di-ester)	2	2	4	1	4	2	4
ANG-25 (Di-ester Base) (TG749)	2	2	4	1	4	2	2
ANG-25 (Glycerol Ester)	2	2	1	1	2	4	2
Aniline	4	4	2	3	4	4	4
Aniline Dyes	4	4	2	2	2	4	3
Aniline Hydrochloride	2	2	2	2	4	4	3
Aniline Oil	4	4	2	3	4	4	4
Aniline Sulfate	3	3	1	3	1	4	2
Aniline Sulfite	3	3	1	3	1	4	2
Animal Fats	1	1	2	1	2	X	X
Animal Oil (Lard Oil)	1	1	2	1	2	1	2
AN-O-3 Grade M	1	1	4	1	2	1	2
AN-O-366	1	1	4	1	2	1	4
AN-O-6	1	1	4	1	2	1	4
Ansul Ether 161 or 181	3	3	3	4	4	4	4
Anthracene	2	2	4	1	4	4	X
Anti-freeze Solutions	3	3	1	3	1	4	2
Antimony Chloride	1	1	4	1	2	1	4

COMPOUND COMPATIBILITY RATING 1 — Satisfactory 2 — Fair (usually OK for static seal) 3 — Doubtful (sometimes OK for static seal) 4 — Unsatisfactory X — Insufficient Data							
	Nitrile NBR	Hydrogenated Nitrile HNBR	Ethylene Propylene EPDM	Fluorocarbon FKM	Neoprene/Chloroprene CR	Polyacrylate ACM	Silicone MQ, VMQ, PVMQ
Antimony Pentachloride	1	1	4	1	2	1	4
Antimony Tribromide	1	1	4	1	2	1	4
Antimony Trichloride	1	1	4	1	2	1	4
Antimony Trifluoride	1	1	4	1	2	1	4
Antimony Trioxide	1	1	4	1	2	1	4
AN-VV-O-366b Hydr. Fluid	1	1	4	1	2	2	4
Aqua Regia	4	3	3	2	4	X	X
Argon	1	1	1	1	1	1	1
Aroclor, 1248	3	3	2	1	4	4	2
Aroclor, 1254	4	4	2	1	4	4	3
Aroclor, 1260	1	1	X	1	1	4	1
Aromatic Fuel -50%	2	2	4	1	4	4	4
Arsenic Acid	1	1	1	1	1	3	1
Arsenic Trichloride	1	1	4	4	1	X	X
Arsenic Trioxide	1	1	4	4	1	X	X
Arsenic Trisulfide	1	1	4	4	1	X	X
Ascorbic Acid	3	3	1	3	1	4	2
Askarel Transformer Oil	2	2	4	1	4	4	4
Aspartic Acid	3	3	1	3	1	4	2
Asphalt	2	2	4	1	2	2	4
ASTM Oil, No. 1	1	1	4	1	1	1	1
ASTM Oil, No. 2	1	1	4	1	2	1	4
ASTM Oil, No. 3	1	1	4	1	4	1	3
ASTM Oil, No. 4	2	2	4	1	4	2	4
ASTM Oil, No. 5	1	1	4	1	2	X	X
ASTM Reference Fuel A	1	1	4	1	2	2	4
ASTM Reference Fuel B	1	1	4	1	4	4	4
ASTM Reference Fuel C	2	2	4	1	4	4	4
ASTM Reference Fuel D	2	2	4	1	4	X	X
ATL-857	2	2	4	1	4	2	4
Atlantic Dominion F	1	1	4	1	2	1	4
Atlantic Utro Gear-e	1	1	4	1	2	X	X
Atlantic Utro Gear-EP Lube	1	1	4	1	2	1	4
Aure 903R (Mobil)	1	1	4	1	2	1	4
Automatic Transmission Fluid	1	1	4	1	2	1	4
Automotive Brake Fluid	3	3	1	4	2	4	3
B							
Bardol B	4	4	4	1	4	4	4
Barium Carbonate	3	3	1	3	1	4	2
Barium Chlorate	3	3	1	3	1	4	2
Barium Chloride	1	1	1	1	1	1	1
Barium Cyanide	1	1	1	1	1	1	1
Barium Hydroxide	1	1	1	1	1	4	1
Barium Iodide	1	1	1	1	1	1	1
Barium Nitrate	3	3	1	3	1	4	2
Barium Oxide	1	1	1	1	1	4	1
Barium Peroxide	3	3	1	3	1	4	2
Barium Polysulfide	3	3	1	3	1	4	2
Barium Salts	1	1	1	1	1	1	1
Barium Sulfate	1	1	1	1	1	X	X
Barium Sulfide	1	1	1	1	1	4	1
Bayol 35	1	1	4	1	2	1	4
Bayol D	1	1	4	1	2	1	4
Beer	1	1	1	1	1	4	1
Beet Sugar Liquids	1	1	1	1	1	X	X
Beet Sugar Liquors	1	1	1	1	2	4	1
Benzaldehyde	4	4	1	4	4	4	2
Benzamide	2	2	4	1	4	4	X

03/03/06



COMPOUND COMPATIBILITY RATING 1 — Satisfactory 2 — Fair (usually OK for static seal) 3 — Doubtful (sometimes OK for static seal) 4 — Unsatisfactory X — Insufficient Data							
	Nitrile NBR	Hydrogenated Nitrile HNBR	Ethylene Propylene EPDM	Fluorocarbon FKM	Neoprene/Chloroprene CR	Polyacrylate ACM	Silicone MQ, VMQ, PVMQ
Benzanthrone	2	2	4	1	4	4	X
Benzene	4	4	4	1	4	4	4
Benzenesulfonic Acid 10%	4	4	4	1	2	4	4
Benzidine	2	2	4	1	4	4	X
Benzidine 3 Sulfonic Acid	2	2	4	1	4	4	X
Benzil	2	2	4	1	4	4	X
Benzilic Acid	2	2	4	1	4	4	X
Benzine (Ligroin)	1	1	4	1	2	1	4
Benzocatechol	2	2	4	1	4	4	X
Benzochloride	4	4	1	1	4	4	X
Benzoic Acid	4	4	4	1	4	4	4
Benzoin	2	2	4	1	4	4	X
Benzonitrile	3	3	1	3	1	4	2
Benzophenone	X	X	2	1	X	4	X
Benzoquinone	X	X	2	1	X	4	X
Benzotrichloride	4	4	1	1	4	X	X
Benzotrifluoride	4	4	1	1	4	X	X
Benzoyl Chloride	X	X	X	1	4	4	X
Benzoylsulfonic Acid	2	2	4	1	4	4	X
Benzyl Acetate	3	3	1	3	1	4	2
Benzyl Alcohol	4	4	2	1	2	4	2
Benzyl Benzoate	4	4	4	1	4	4	4
Benzyl Bromide	4	4	4	1	4	4	4
Benzyl Butyl Phthalate	3	3	1	3	1	4	2
Benzyl Chloride	4	4	4	1	4	4	4
Benzyl Phenol	2	2	4	1	4	4	X
Benzyl Salicylate	2	2	4	1	4	4	X
Beryllium Chloride	1	1	1	1	3	3	3
Beryllium Fluoride	1	1	1	1	3	3	3
Beryllium Oxide	1	1	1	1	3	3	3
Beryllium Sulfate	3	3	1	3	1	4	2
Bismuth Carbonate	3	3	1	3	1	4	2
Bismuth Nitrate	3	3	1	3	1	4	2
Bismuth Oxychloride	3	3	1	3	1	4	2
Black Liquor	2	X	1	1	1	X	X
Black Point 77	1	1	1	1	3	3	3
Blast Furnace Gas	4	4	4	1	4	4	1
Bleach Liquor	3	3	1	1	2	4	2
Bleach Solutions	X	X	1	1	X	X	X
Borax	2	2	1	1	4	2	2
Borax Solutions	X	X	1	1	X	X	X
Bordeaux Mixture	2	2	1	1	2	4	2
Boric Acid	1	1	1	1	1	4	1
Boric Oxide	3	3	1	3	1	4	2
Borneol	2	2	4	1	4	4	X
Bornyl Acetate	2	2	4	1	4	4	X
Bornyl Chloride	2	2	4	1	4	4	X
Bornyl Formate	2	2	4	1	4	4	X
Boron Fluids (HEF)	2	2	4	1	4	4	4
Brake Fluid DOT3 (Glycol Type)	3	3	1	4	2	X	3
Bray GG-130	2	2	4	1	4	2	4
Brayco 719-R (VV-H-910)	3	3	1	4	2	4	2
Brayco 885 (MIL-L-6085A)	2	2	4	1	4	2	4
Brayco 910	2	2	1	4	2	3	4
Bret 710	2	2	1	4	2	3	4
Brine	1	1	1	1	X	X	X
Brine (Seawater)	1	1	3	1	4	X	X
Brom - 113	3	3	4	X	4	X	4

COMPOUND COMPATIBILITY RATING 1 — Satisfactory 2 — Fair (usually OK for static seal) 3 — Doubtful (sometimes OK for static seal) 4 — Unsatisfactory X — Insufficient Data							
	Nitrile NBR	Hydrogenated Nitrile HNBR	Ethylene Propylene EPDM	Fluorocarbon FKM	Neoprene/Chloroprene CR	Polyacrylate ACM	Silicone MQ, VMQ, PVMQ
Brom - 114	2	2	4	2	2	X	4
Bromic Acid	3	3	1	3	1	4	2
Bromine	4	4	4	1	4	4	4
Bromine Pentafluoride	4	4	4	4	4	4	4
Bromine Trifluoride	4	4	4	4	4	4	4
Bromine Water	4	4	2	1	4	4	4
Bromobenzene	4	4	4	1	4	4	4
Bromobenzene Cyanide	3	3	1	3	1	4	2
Bromochlorotrifluoroethane (Halothane)	4	4	4	1	4	4	4
Bromoform	2	2	4	1	4	4	X
Bromomethane (Methyl Bromide)	2	2	4	1	4	3	X
Brucine Sulfate	3	3	1	3	1	4	2
Bunker Oil	1	1	4	1	4	1	2
Bunker's "C" (Fuel Oil)	1	X	X	1	X	X	X
Butadiene (Monomer)	4	4	4	1	4	4	4
Butane	1	1	4	1	1	1	4
Butane, 2, 2-Dimethyl	1	1	4	1	2	1	4
Butane, 2, 3-Dimethyl	1	1	4	1	2	1	4
Butanedial	3	3	1	3	1	4	2
Butanol (Butyl Alcohol)	1	1	2	1	1	4	2
Butene 2-Ethyl (1-Butene 2-Ethyl)	1	1	4	1	4	1	4
Butter-Animal Fat	1	1	1	1	2	1	2
Butyl Acetate or n-Butyl Acetate	4	4	2	4	4	4	4
Butyl Acetyl Ricinoleate	2	2	1	1	2	X	X
Butyl Acrylate	4	4	1	4	4	4	2
Butyl Alcohol	1	1	2	1	1	4	2
Butyl Alcohol (Secondary)	2	2	2	1	2	4	2
Butyl Alcohol (Tertiary)	2	2	1	2	4	2	
Butyl Amine or N-Butyl Amine	1	1	3	4	4	4	4
Butyl Benzoate	3	3	1	3	1	4	2
Butyl Benzoate or n-Butyl Benzoate	4	4	1	1	4	4	X
Butyl Butyrate or n-Butyl Butyrate	4	4	1	1	4	4	X
Butyl Carbitol	4	4	1	3	3	4	4
Butyl Cellosolve	3	3	2	4	3	4	X
Butyl Cellosolve Acetate	3	3	1	3	1	4	2
Butyl Cellosolve Adipate	4	4	2	2	4	4	2
Butyl Chloride	1	1	4	1	2	1	2
Butyl Ether or n-Butyl Ether	3	3	3	4	4	4	4
Butyl Glycolate	3	3	1	3	1	4	2
Butyl Lactate	3	3	1	3	1	4	2
Butyl Laurate	3	3	1	3	1	4	2
Butyl Mercaptan (Tertiary)	4	4	4	1	4	4	4
Butyl Methacrylate	3	3	1	3	1	4	2
Butyl Oleate	4	4	2	1	4	X	X
Butyl Oxalate	3	3	1	3	1	4	2
Butyl Stearate	2	2	4	1	4	X	X
Butylbenzoic Acid	2	2	4	1	4	4	X
Butylene	2	2	4	1	3	4	4
Butyraldehyde	4	4	2	4	4	4	4
Butyric Acid	4	4	2	2	4	4	X
Butyric Anhydride	3	3	1	3	1	4	4
Butyrolactone	3	3	1	3	1	4	2
Butyryl Chloride	2	2	4	1	4	4	X
C							
Cadmium Chloride	3	3	1	3	1	4	2
Cadmium Cyanide	3	3	1	3	1	4	2
Cadmium Nitrate	3	3	1	3	1	4	2
Cadmium Oxide	3	3	1	3	1	4	2



Chemical Compatibility

COMPOUND COMPATIBILITY RATING 1 — Satisfactory 2 — Fair (usually OK for static seal) 3 — Doubtful (sometimes OK for static seal) 4 — Unsatisfactory X — Insufficient Data							
	Nitrile NBR	Hydrogenated Nitrile HNBR	Ethylene Propylene EPDM	Fluorocarbon FKM	Neoprene/Chloroprene CR	Polyacrylate ACM	Silicone MQ, VMQ, PVMQ
Cadmium Sulfate	3	3	1	3	1	4	2
Cadmium Sulfide	3	3	1	3	1	4	2
Calcine Liquors	1	1	1	1	X	4	X
Calcium Acetate	2	2	1	4	2	4	4
Calcium Arsenate	3	3	1	3	1	4	2
Calcium Benzoate	2	2	4	1	4	4	X
Calcium Bicarbonate	3	3	1	3	1	4	2
Calcium Bisulfide	3	3	1	3	1	4	2
Calcium Bisulfite	2	2	1	2	2	3	3
Calcium Bromide	1	1	1	1	1	1	1
Calcium Carbonate	1	1	1	1	1	3	1
Calcium Chlorate	3	3	1	3	1	4	2
Calcium Chloride	1	1	1	1	1	1	1
Calcium Chromate	3	3	1	3	1	4	2
Calcium Cyanide	1	1	1	X	1	X	1
Calcium Fluoride	1	1	1	1	1	1	1
Calcium Gluconate	3	3	1	3	1	4	2
Calcium Hydride	1	1	1	1	1	1	1
Calcium Hydrosulfide	3	3	1	3	1	4	2
Calcium Hydroxide	1	1	1	1	1	4	1
Calcium Hypochlorite	2	2	1	1	2	4	2
Calcium Hypophosphite	3	3	1	3	1	4	2
Calcium Lactate	3	3	1	3	1	4	2
Calcium Nitrate	1	1	1	1	1	1	2
Calcium Oxalate	3	3	1	3	1	4	2
Calcium Oxide	1	1	1	1	1	1	1
Calcium Phenolsulfonate	3	3	1	3	1	4	2
Calcium Phosphate	1	1	1	1	2	1	1
Calcium Phosphate Acid	3	3	1	3	1	4	2
Calcium Propionate	3	3	1	3	1	4	2
Calcium Salts	1	1	1	1	1	1	2
Calcium Silicate	1	1	1	1	1	X	X
Calcium Stearate	2	2	4	1	4	4	X
Calcium Sulfamate	2	2	4	1	4	4	X
Calcium Sulfate	3	3	1	3	1	4	2
Calcium Sulfide	1	1	1	1	1	4	1
Calcium Sulfite	1	1	1	1	1	4	1
Calcium Thiocyanate	3	3	1	3	1	4	2
Calcium Thiosulfate	2	2	1	1	1	4	1
Calcium Tungstate	3	3	1	3	1	4	2
Caliche Liquors	1	1	1	1	1	1	2
Camphene	2	2	4	1	4	4	X
Camphor	2	2	4	1	4	4	X
Camphoric Acid	2	2	4	1	4	4	X
Cane Sugar Liquors	1	1	1	1	1	4	1
Capric Acid	1	1	4	1	2	1	2
Caproic Acid	1	1	4	1	2	1	2
Caproic Aldehyde	X	X	2	4	X	4	2
Caprolactam	1	1	4	1	2	1	2
Capronaldehyde	1	1	4	1	2	1	2
Carbamate	3	3	2	1	2	4	X
Carbitol	2	2	2	2	2	4	2
Carbolic Acid (Phenol)	4	4	2	1	4	4	4
Carbon Bisulfide	4	4	4	1	4	3	4
Carbon Dioxide	1	1	1	1	1	1	1
Carbon Dioxide (Explosive Decompression Use)	1	1	1	1	1	1	1
Carbon Disulfide	4	4	4	1	4	3	4
Carbon Fluorides	2	2	4	1	4	4	4

COMPOUND COMPATIBILITY RATING 1 — Satisfactory 2 — Fair (usually OK for static seal) 3 — Doubtful (sometimes OK for static seal) 4 — Unsatisfactory X — Insufficient Data							
	Nitrile NBR	Hydrogenated Nitrile HNBR	Ethylene Propylene EPDM	Fluorocarbon FKM	Neoprene/Chloroprene CR	Polyacrylate ACM	Silicone MQ, VMQ, PVMQ
Carbon Monoxide	1	1	1	1	2	X	1
Carbon Tetrachloride	2	2	4	1	4	4	4
Carbon Tetrafluoride	2	2	4	1	4	4	4
Carbonic Acid	2	2	1	1	1	1	1
Casein	3	3	1	3	1	4	2
Castor Oil	1	1	2	1	1	1	1
Caustic Lime	3	3	1	3	1	4	2
Caustic Potash	3	3	1	3	1	4	2
Caustic Soda (Sodium Hydroxide)	3	3	1	3	1	4	2
Cellosolve	4	4	2	4	4	4	4
Cellosolve, Acetate	4	4	2	4	4	4	4
Cellosolve, Butyl	4	4	2	4	4	4	4
Celluguard	1	1	1	1	1	3	1
Cellulose Acetate	3	3	1	3	1	4	2
Cellulose Acetate Butyrate	3	3	1	3	1	4	2
Cellulose Ether	3	3	1	3	1	4	2
Cellulose Nitrate*	3	3	1	3	1	4	2
Cellulose Tripropionate	3	3	1	3	1	4	2
Cellultherm 2505A	2	2	4	1	4	2	4
Cerium Sulfate	3	3	1	3	1	4	2
Cerous Chloride	3	3	1	3	1	4	2
Cerous Fluoride	3	3	1	3	1	4	2
Cerous Nitrate	3	3	1	3	1	4	2
Cetane (Hexadecane)	1	1	4	1	2	1	4
Cetyl Alcohol	1	1	4	1	2	1	2
China Wood Oil (Tung Oil)	1	1	4	1	2	X	4
Chloral	3	3	1	3	1	4	2
Chloranthraquinone	2	2	4	1	4	4	X
Chlordane	2	2	4	1	3	X	4
Chlorextol	2	2	4	1	2	2	4
Chloric Acid	3	3	1	3	1	4	2
Chlorinated Solvents, Dry	4	4	4	1	4	4	4
Chlorinated Solvents, Wet	4	4	4	1	4	4	4
Chlorine (Dry)	2	2	4	1	4	4	X
Chlorine Dioxide	4	4	3	1	4	4	X
Chlorine Dioxide, 8% Cl as NaClO ₂ in solution	4	4	4	1	4	4	X
Chlorine Trifluoride	4	4	4	4	4	4	4
Chlorine Water	3	3	2	1	4	X	X
Chloro 1-Nitro Ethane (1-Chloro 1-Nitro Ethane)	4	4	4	4	4	4	4
Chloro Xylenols	2	2	4	1	4	4	X
Chloroacetaldehyde	3	3	1	3	1	4	2
Chloroacetic Acid	4	4	2	4	4	4	X
Chloroacetone	4	4	1	4	4	4	4
Chloroamino Benzoic Acid	3	3	1	3	1	4	2
Chloroaniline	3	3	1	3	1	4	2
Chlorobenzaldehyde	3	3	1	3	1	4	2
Chlorobenzene	4	4	4	1	4	4	4
Chlorobenzene (Mono)	4	4	4	1	4	4	4
Chlorobenzene Chloride	2	2	4	1	4	4	X
Chlorobenzene Trifluoride	2	2	4	1	4	4	X
Chlorobenzochloride	2	2	4	1	4	4	X
Chlorobenzotrifluoride	2	2	4	1	4	4	X
Chlorobromo Methane	4	4	2	1	4	4	4
Chlorobromopropane	2	2	4	1	4	4	X
Chlorobutadiene	4	4	4	1	4	4	4
Chlorobutane (Butyl Chloride)	1	1	4	1	2	1	2
Chlorododecane	4	4	4	1	4	4	4
Chloroethane	1	1	4	1	2	1	2

03/03/06



Chemical Compatibility

COMPOUND COMPATIBILITY RATING 1 — Satisfactory 2 — Fair (usually OK for static seal) 3 — Doubtful (sometimes OK for static seal) 4 — Unsatisfactory X — Insufficient Data							
	Nitrile NBR	Hydrogenated Nitrile HNBR	Ethylene Propylene EPDM	Fluorocarbon FKM	Neoprene/Chloroprene CR	Polyacrylate ACM	Silicone MQ, VMQ, PVMQ
Chloroethane Sulfonic Acid	3	3	1	3	1	4	2
Chloroethylbenzene	2	2	4	1	4	4	X
Chloroform	4	4	4	1	4	4	4
Chlorohydrin	3	3	1	3	1	4	2
Chloronaphthalene or o-Chloronaphthalene	4	4	4	1	4	4	4
Chloronitrobenzene	3	3	1	3	1	4	2
Chlorophenol or o-Chlorophenol	4	4	4	1	4	4	4
Chloropicrin	2	2	4	1	4	4	X
Chloroprene	2	2	4	1	4	4	X
Chlorosulfonic Acid	4	4	4	4	4	4	4
Chlorotoluene	4	4	4	1	4	4	4
Chlorotoluene Sulfonic Acid	3	3	1	3	1	4	2
Chlorotoluidine	2	2	4	1	4	4	X
Chloro	2	2	2	1	2	4	X
Cholesterol	2	2	4	1	4	4	X
Chrome Alum	1	1	1	1	1	4	1
Chrome Plating Solutions	4	4	2	1	4	4	2
Chromic Acid	4	4	2	1	4	4	X
Chromic Oxide	4	4	2	1	4	X	X
Chromium Potassium Sulfate (Alum)	2	X	2	1	X	X	X
Cinnamic Acid	2	2	4	1	4	4	X
Cinnamic Alcohol	2	2	4	1	4	4	X
Cinnamic Aldehyde	2	2	4	1	4	4	X
Circo Light Process Oil	1	1	4	1	2	1	4
Citric Acid	1	1	1	1	1	X	1
City Service #65 #120 #250	1	1	4	1	2	1	4
City Service Koolmoter-AP Gear Oil 140-EP Lube	1	1	4	1	2	1	4
City Service Pacemaker #2	1	1	4	1	2	1	4
Clorox	2	X	2	1	X	X	X
Coal Tar	1	X	X	1	X	X	X
Cobalt Chloride	1	1	1	1	1	1	2
Cobalt Chloride, 2N	1	1	1	1	1	4	1
Cobaltous Acetate	3	3	1	3	1	4	2
Cobaltous Bromide	1	1	1	1	1	4	1
Cobaltous Sulfate	3	3	1	3	1	4	2
Coconut Oil	1	1	3	1	3	1	1
Cod Liver Oil	1	1	1	1	2	1	2
Codeine	2	2	4	1	4	4	X
Coffee	1	1	1	1	1	4	1
Coke Oven Gas	4	4	4	1	4	4	2
Coliche Liquors	2	2	2	X	1	X	X
Convelex 10	4	4	X	X	4	X	4
Coolanol 20 25R 35R 40& 45A (Monsanto)	1	1	3	1	2	4	4
Copper Acetate	2	2	1	4	2	4	4
Copper Ammonium Acetate	3	3	1	3	1	4	2
Copper Carbonate	3	3	1	3	1	4	2
Copper Chloride	1	1	1	1	2	1	1
Copper Cyanide	1	1	1	1	1	1	1
Copper Gluconate	3	3	1	3	1	4	2
Copper Nitrate	2	X	2	1	X	X	X
Copper Oxide	1	1	1	1	1	1	1
Copper Salts	1	1	1	1	1	1	1
Copper Sulfate	1	1	1	1	1	4	1
Copper Sulfate 10%	1	1	1	1	1	4	1
Copper Sulfate 50%	1	1	1	1	1	4	1
Corn Oil	1	1	3	1	3	1	1
Cottonseed Oil	1	1	3	1	3	1	1
Creosote, Coal Tar	1	1	4	1	2	1	4

COMPOUND COMPATIBILITY RATING 1 — Satisfactory 2 — Fair (usually OK for static seal) 3 — Doubtful (sometimes OK for static seal) 4 — Unsatisfactory X — Insufficient Data							
	Nitrile NBR	Hydrogenated Nitrile HNBR	Ethylene Propylene EPDM	Fluorocarbon FKM	Neoprene/Chloroprene CR	Polyacrylate ACM	Silicone MQ, VMQ, PVMQ
Creosote, Wood	1	1	4	1	2	1	4
Cresol (Methyl Phenol)	X	X	X	1	X	X	X
Cresols	4	4	4	2	4	4	4
Cresylic Acid	4	4	4	1	4	4	4
Crotonaldehyde	2	2	4	1	4	4	X
Crotonic Acid	2	2	4	1	4	4	X
Crude Oil	2	2	4	1	4	1	4
Cumaldehyde	2	2	4	1	4	4	X
Cumene	4	4	4	1	4	4	4
Cupric Sulfate	2	X	2	1	X	X	X
Cutting Oil	1	1	4	1	2	1	4
Cyclohexane	1	1	4	1	3	2	4
Cyclohexanol	1	1	4	1	2	X	4
Cyclohexanone	4	4	2	4	4	4	4
Cyclohexene	2	2	4	1	4	4	X
Cyclohexylamine	1	1	4	1	2	1	2
Cyclohexylamine Laurate	1	1	4	1	2	1	2
Cyclopentadiene	2	2	4	1	4	4	X
Cyclopentane	1	1	4	1	3	2	4
Cyclopolyolefins	1	1	4	1	3	2	4
Cymene or p-Cymene	4	4	4	1	4	4	4
D							
DDT (Dichlorodiphenyltrichloroethane)	2	2	4	1	4	4	X
Decalin	4	4	4	1	4	X	4
Decane	1	1	4	1	3	1	2
Delco Brake Fluid	3	3	1	4	2	X	3
Denatured Alcohol	1	1	1	1	1	4	1
Detergent, Water Solution	1	1	1	1	2	4	1
Developing Fluids (Photo)	1	1	2	1	1	X	1
Dexron	1	1	4	1	2	1	4
Dextrin	1	1	4	1	2	1	2
Dextro Lactic Acid	3	3	1	3	1	4	2
Dextron	1	1	4	1	2	X	X
Dextrose	3	3	1	3	1	4	2
DI Water	2	X	1	2	1	4	2
Diacetone	4	4	1	4	4	4	4
Diacetone Alcohol	4	4	1	4	2	4	4
Dialkyl Sulfates	3	3	1	3	1	4	2
Diamylamine	1	1	4	1	2	1	2
Diazinon	3	3	4	2	3	X	4
Dibenzyl (sym-Diphenylethane)	2	2	4	1	4	4	X
Dibenzyl Ether	4	4	2	4	4	X	X
Dibenzyl Sebacate	4	4	2	2	4	4	3
Dibromoethane	2	2	4	1	4	4	X
Dibromoethyl Benzene	4	4	4	1	4	4	4
Dibutyl Cellosolve Adipate	3	3	1	3	1	4	2
Dibutyl Ether	4	4	3	3	4	3	4
Dibutyl Methyleneidithio Glycolate	2	2	4	1	4	4	X
Dibutyl Phthalate	4	4	2	3	4	4	2
Dibutyl Sebacate	4	4	2	2	4	4	2
Dibutyl Thioglycolate	2	2	4	1	4	4	X
Dibutyl Thiourea	2	2	4	1	4	4	X
Dibutylamine	4	4	1	4	3	4	3
Dichloroacetic Acid	2	2	4	1	4	4	X
Dichloroaniline	3	3	1	3	1	4	2
Dichlorobenzene or o-Dichlorobenzene	4	4	4	1	4	4	4
Dichlorobenzene or p-Dichlorobenzene	4	4	4	1	4	4	4
Dichlorobutane	2	2	4	1	4	4	4



03/03/06



Chemical Compatibility

COMPOUND COMPATIBILITY RATING 1 — Satisfactory 2 — Fair (usually OK for static seal) 3 — Doubtful (sometimes OK for static seal) 4 — Unsatisfactory X — Insufficient Data							
	Nitrile NBR	Hydrogenated Nitrile HNBR	Ethylene Propylene EPDM	Fluorocarbon FKM	Neoprene/Chloroprene CR	Polyacrylate ACM	Silicone MQ, VMQ, PVMQ
Dichlorobutene	2	2	4	1	4	4	X
Dichlorodiphenyl-Dichloroethane (DDD)	2	2	4	1	4	4	X
Dichloroethane	2	2	4	1	4	4	X
Dichloroethylene	2	2	4	1	4	4	X
Dichlorohydrin	3	3	1	3	1	4	2
Dichloroisopropyl Ether	4	4	3	3	4	3	4
Dichloromethane	2	2	4	1	4	4	X
Dichlorophenol	2	2	4	1	4	4	X
Dichlorophenoxyacetic Acid	2	2	4	1	4	4	X
Dichloropropane	2	2	4	1	4	4	X
Dichloropropene	2	2	4	1	4	4	X
Dicyclohexylamine	1	1	4	4	4	4	2
Dicyclohexylammonium Nitrate	3	3	1	3	1	4	2
Dieldrin	2	2	4	1	4	4	X
Diesel Oil	1	1	4	1	3	1	4
Di-ester Lubricant MIL-L-7808	2	2	4	1	4	2	4
Di-ester Synthetic Lubricants	2	2	4	1	4	2	4
Diethanolamine (DEA)	3	3	1	3	1	4	2
Diethyl Benzene	X	X	X	1	X	X	X
Diethyl Carbonate	3	3	1	3	1	4	2
Diethyl Ether	4	4	4	4	3	3	4
Diethyl Phthalate	2	2	4	1	4	4	X
Diethyl Sebacate	2	2	2	2	4	4	2
Diethyl Sulfate	4	X	1	3	4	X	2
Diethylamine	2	X	1	4	1	4	2
Diethylaniline	3	3	1	3	1	4	2
Diethylene Glycol	1	1	1	1	1	2	2
Difluorodibromomethane	4	4	2	X	4	4	4
Difluoroethane	2	2	4	1	4	4	X
Difluoromonochloroethane	2	2	4	1	4	4	X
Diglycol Chloroformate	3	3	1	3	1	4	2
Diglycolic Acid	3	3	1	3	1	4	2
Dihydroxydiphenylsulfone	3	3	1	3	1	4	2
Diisobutyl Ketone	X	X	1	X	X	X	X
Diisobutylcarbinol	1	1	4	1	2	1	2
Diisobutylene	2	2	4	1	4	4	4
Diisooctyl Sebacate	3	3	3	2	4	4	3
Diisopropyl Ketone	4	4	1	4	4	4	4
Diisopropylbenzene	2	2	4	1	4	4	X
Diisopropylidene Acetone	2	2	4	1	4	4	X
Dimethyl Acetamide	3	3	1	3	1	4	2
Dimethylaniline (Xylidine)	2	2	4	1	4	4	X
Dimethyldisulfide (DMDS)	1	1	4	1	2	1	2
Dimethyl Ether	1	X	2	2	3	X	X
Dimethyl Formaldehyde	3	3	1	3	1	4	2
Dimethyl Formamide (DMF)	2	2	1	4	3	4	2
Dimethylhydrazine	3	3	1	3	1	4	2
Dimethyl Phenyl Carbinol	2	2	4	1	4	4	X
Dimethyl Phenyl Methanol	2	2	4	1	4	4	X
Dimethyl Phthalate	4	4	2	2	4	4	X
Dimethyl Sulfoxide (DMSO)	3	3	1	3	1	4	2
Dimethyl Terephthalate (DMT)	2	2	4	1	4	4	X
Dimethylamine (DMA)	2	2	1	4	2	4	2
Dinitrochlorobenzene	2	2	4	1	4	4	X
Dinitrotoluene (DNT)	4	4	4	4	4	4	4
Diocetyl Phthalate	4	4	2	2	4	4	3
Diocetyl Sebacate	4	4	2	2	4	4	3
Diocetylamine	1	1	4	1	2	1	2

COMPOUND COMPATIBILITY RATING 1 — Satisfactory 2 — Fair (usually OK for static seal) 3 — Doubtful (sometimes OK for static seal) 4 — Unsatisfactory X — Insufficient Data							
	Nitrile NBR	Hydrogenated Nitrile HNBR	Ethylene Propylene EPDM	Fluorocarbon FKM	Neoprene/Chloroprene CR	Polyacrylate ACM	Silicone MQ, VMQ, PVMQ
Dioxane	4	4	2	4	4	4	4
Dioxolane	4	4	2	4	4	4	4
Dipentene	2	2	4	1	4	4	4
Diphenyl	4	4	4	1	4	4	4
Diphenyl Oxides	4	4	4	1	4	4	3
Diphenylamine (DPA)	2	2	4	1	4	4	X
Diphenylpropane	2	2	4	1	4	4	X
Dodecylbenzene	2	2	4	1	4	4	X
Dow Chemical 50-4	X	X	1	4	2	X	X
Dow Chemical ET378	4	4	X	X	4	3	4
Dow Chemical ET588	3	3	1	4	2	X	X
Dow Corning -11	2	2	1	1	1	1	2
Dow Corning 1208, 4050, 6620, F-60, XF-60	1	1	1	1	1	X	X
Dow Corning -1265 Fluorosilicone Fluid	2	2	1	1	1	1	1
Dow Corning -200	2	2	1	1	1	1	3
Dow Corning -220	1	1	1	1	1	X	X
Dow Corning -3	2	2	1	1	1	1	2
Dow Corning -33	2	2	1	1	1	1	3
Dow Corning -4	2	2	1	1	1	1	2
Dow Corning -44	2	2	1	1	1	1	3
Dow Corning -5	2	2	1	1	1	1	3
Dow Corning -510	2	2	1	1	1	1	3
Dow Corning -55	2	2	1	1	1	1	3
Dow Corning -550	2	2	1	1	1	1	3
Dow Corning -704	2	2	1	1	1	1	3
Dow Corning -705	2	2	1	1	1	1	3
Dow Corning -710	2	2	1	1	1	1	3
Dow Corning F-61	1	1	1	1	1	X	X
Dow Guard	1	1	1	1	1	3	1
Dowtherm, 209	3	3	1	4	2	X	3
Dowtherm, A	4	4	4	1	4	4	4
Dowtherm, E	4	4	4	1	4	4	4
Drinking Water	1	1	1	1	2	4	1
Dry Cleaning Fluids	3	3	4	1	4	4	4
DTE 20 Series, Mobil	2	2	4	1	1	2	4
DTE named series, Mobil, light-heavy	1	1	4	1	2	X	3
E							
Elco 28-EP Lubricant	1	1	4	1	3	1	2
Epichlorohydrin	4	4	2	4	4	4	4
Epoxy Resins	X	X	1	4	1	X	X
Esam-6 Fluid	X	X	1	4	2	X	X
Esso Fuel 208	1	1	4	1	2	1	4
Esso Golden Gasoline	2	2	4	1	4	4	4
Esso Motor Oil	1	1	4	1	3	1	4
Esso Transmission Fluid (Type A)	1	1	4	1	2	1	4
Esso WS2812 (MIL-L-7808A)	1	1	4	1	4	2	4
Esso XP90-EP Lubricant	1	1	4	1	2	1	4
Esstic 42, 43	1	1	4	1	2	1	4
Ethane	1	1	4	1	2	1	4
Ethanol	3	3	1	3	1	4	2
Ethanol Amine	2	2	1	4	2	4	2
Ethers	4	4	3	3	4	3	4
Ethoxyethyl Acetate (EGMEEA)	3	3	1	3	1	4	2
Ethyl Acetate-Organic Ester	4	4	2	4	4	4	2
Ethyl Acetoacetate	4	4	2	4	4	4	2
Ethyl Acrylate	4	4	2	4	4	4	2
Ethyl Alcohol	3	3	1	3	1	4	2
Ethyl Benzene	4	4	4	1	4	4	4

03/03/06



Chemical Compatibility

COMPOUND COMPATIBILITY RATING 1 — Satisfactory 2 — Fair (usually OK for static seal) 3 — Doubtful (sometimes OK for static seal) 4 — Unsatisfactory X — Insufficient Data							
	Nitrile NBR	Hydrogenated Nitrile HNBR	Ethylene Propylene EPDM	Fluorocarbon FKM	Neoprene/Chloroprene CR	Polyacrylate ACM	Silicone MQ, VMQ, PVMQ
Ethyl Benzoate	4	4	4	1	4	4	4
Ethyl Bromide	2	2	4	1	4	X	X
Ethyl Cellosolve	4	4	2	4	4	4	4
Ethyl Cellulose	2	2	2	4	2	4	2
Ethyl Chloride	1	1	3	1	4	3	4
Ethyl Chlorocarbonate	4	4	2	1	4	4	4
Ethyl Chloroformate	4	4	2	4	4	4	4
Ethyl Ether	3	3	3	4	4	4	4
Ethyl Formate	4	4	2	1	2	X	X
Ethyl Hexanol	1	1	1	1	1	4	2
Ethyl Lactate	3	3	1	3	1	4	2
Ethyl Mercaptan	4	4	X	2	3	X	3
Ethyl Nitrite	3	3	1	3	1	4	2
Ethyl Oxalate	4	4	1	2	4	4	4
Ethyl Pentachlorobenzene	4	4	4	1	4	4	4
Ethyl Pyridine	2	2	4	1	4	4	X
Ethyl Silicate	1	1	1	1	1	X	X
Ethyl Stearate	2	2	4	1	4	4	X
Ethyl Sulfate	X	X	1	4	X	X	X
Ethyl Valerate	2	2	4	1	4	4	X
Ethylacrylic Acid	4	4	2	X	2	4	4
Ethylamine	3	3	1	3	1	4	2
Ethylcyclopentane	1	1	4	1	3	2	4
Ethylene	3	2	4	2	4	4	4
Ethylene Chloride	4	4	4	2	4	4	4
Ethylene Chlorohydrin	4	4	2	1	2	4	3
Ethylene Cyanohydrin	2	2	4	1	4	4	X
Ethylene Diamine	1	1	1	4	1	4	1
Ethylene Dibromide	4	4	3	1	4	4	4
Ethylene Dichloride	4	4	3	1	4	4	4
Ethylene Glycol	1	1	1	1	1	4	1
Ethylene Hydrochloride	4	4	3	1	4	4	4
Ethylene Oxide	4	4	3	4	4	4	4
Ethylene Oxide, (12%) and Freon 12 (80%)	3	3	2	4	4	4	4
Ethylene Trichloride	4	4	3	1	4	4	4
Ethylmorpholine Stannous Octoate (50/50 mixture)	4	4	2	4	X	X	X
Ethylmorpholine	2	2	4	1	4	4	X
Ethylsulfuric Acid	3	3	1	3	1	4	2
F							
F-60 Fluid (Dow Corning)	1	1	1	1	1	1	4
F-61 Fluid (Dow Corning)	1	1	1	1	1	1	4
Fatty Acids	2	2	3	1	2	X	3
FC-43 Heptacosofluorotri-butylamine	1	1	1	1	1	X	1
FC75 & FC77 (Fluorocarbon)	1	1	1	2	1	X	1
Ferric Acetate	3	3	1	3	1	4	2
Ferric Ammonium Sulfate	3	3	1	3	1	4	2
Ferric Chloride	1	1	1	1	2	1	2
Ferric Ferrocyanide	3	3	1	3	1	4	2
Ferric Hydroxide	3	3	1	3	1	4	2
Ferric Nitrate	1	1	1	1	1	1	2
Ferric Persulfate	1	1	1	1	1	X	X
Ferric Sulfate	1	1	1	1	1	X	X
Ferrous Ammonium Citrate	3	3	1	3	1	4	2
Ferrous Ammonium Sulfate	3	3	1	3	1	4	2
Ferrous Carbonate	3	3	1	3	1	4	2
Ferrous Iodide	3	3	1	3	1	4	2
Ferrous Sulfate	3	3	1	3	1	4	2
Ferrous Tartrate	3	3	1	3	1	4	2

COMPOUND COMPATIBILITY RATING 1 — Satisfactory 2 — Fair (usually OK for static seal) 3 — Doubtful (sometimes OK for static seal) 4 — Unsatisfactory X — Insufficient Data							
	Nitrile NBR	Hydrogenated Nitrile HNBR	Ethylene Propylene EPDM	Fluorocarbon FKM	Neoprene/Chloroprene CR	Polyacrylate ACM	Silicone MQ, VMQ, PVMQ
Fish Oil	2	2	4	1	4	4	X
Fisher Reagent	X	X	2	X	X	X	X
Fluorinated Cyclic Ethers	X	X	1	X	X	X	X
Fluorine (Liquid)	4	4	4	2	X	X	X
Fluorobenzene	2	2	4	1	4	4	X
Fluoroboric Acid	1	X	1	X	X	X	X
Fluorocarbon Oils	X	X	1	X	X	X	X
Fluorolube	1	1	1	2	1	X	1
Fluorosilicic Acid	1	1	2	2	1	X	X
Formaldehyde	3	3	2	4	3	4	2
Formamide	3	3	1	3	1	4	2
Formic Acid	X	X	1	4	1	X	X
Freon, 11	4	4	4	2	4	4	4
Freon, 112 (Tetrachlorodifluoroethane)	2	2	4	1	2	X	4
Freon, 113	1	1	4	2	1	X	4
Freon, 113 + High and Low Aniline Oil	1	X	X	X	X	X	X
Freon, 114	1	1	1	1	1	X	4
Freon, 114B2	2	2	4	2	2	X	4
Freon, 115, 116	1	1	1	2	1	X	X
Freon, 12	2	2	3	3	1	X	4
Freon, 12 and ASTM Oil #2 (50/50 Mixture)	2	2	4	1	3	X	4
Freon, 12 and Suniso 4G (50/50 Mixture)	2	2	4	1	3	X	4
Freon, 13	1	1	1	1	1	X	4
Freon, 13B1	1	1	1	1	1	X	4
Freon, 14	1	1	1	1	1	X	4
Freon, 142b	2	2	4	2	1	X	X
Freon, 21	4	4	4	4	3	X	4
Freon, 218	1	X	1	1	X	X	X
Freon, 22 (Chlorodifluoroethane)	4	4	3	4	1	2	4
Freon, 22 and ASTM Oil #2 (50/50 Mixture)	4	4	4	2	2	2	4
Freon, 31	4	4	1	4	1	X	X
Freon, 32	1	1	1	4	1	X	X
Freon, 502	2	2	1	2	1	X	X
Freon, BF (R112)	2	2	4	1	2	X	4
Freon, C316	1	X	1	1	X	X	X
Freon, C318	1	1	1	2	1	X	X
Freon, K-142b	1	1	1	4	1	X	X
Freon, K-152a	1	1	1	4	1	X	X
Freon, MF (R11)	2	2	4	2	4	X	4
Freon, PCA (R113)	1	1	4	2	1	X	4
Freon, TA	1	X	2	3	X	X	X
Freon, TC	1	X	2	1	X	X	X
Freon, TF (R113)	1	1	4	2	1	X	4
Freon, TMC	2	X	3	1	X	X	X
Freon, T-P35	1	X	1	1	X	X	X
Freon, T-WD602	2	X	2	1	X	X	X
Fuel Oil, #6	2	2	4	1	4	1	1
Fuel Oil, 1, and 2	1	1	4	1	2	1	4
Fuel Oil, Acidic	1	1	4	1	2	1	1
Fumaric Acid	1	1	2	1	2	4	2
Fuming Sulphuric Acid (20/25% Oleum)	4	4	4	1	4	4	4
Furaldehyde	4	4	2	4	4	X	X
Furan (Furfuran)	4	4	3	1	4	4	X
Furfural (Furfuraldehyde)	4	4	2	4	4	4	4
Furfuraldehyde	4	4	2	4	4	4	4
Furfuryl Alcohol	4	4	2	X	4	4	4
Furyl Carbinol	4	4	2	X	4	4	4
Fyrquel 150 220 300 550	4	4	1	1	4	4	1



03/03/06



Chemical Compatibility

COMPOUND COMPATIBILITY RATING 1 — Satisfactory 2 — Fair (usually OK for static seal) 3 — Doubtful (sometimes OK for static seal) 4 — Unsatisfactory X — Insufficient Data	Nitrile NBR	Hydrogenated Nitrile HNBR	Ethylene Propylene EPDM	Fluorocarbon FKM	Neoprene/Chloroprene CR	Polyacrylate ACM	Silicone MQ, VMQ, PVMQ
Fyrquel A60	4	4	2	4	4	X	X
G							
Gallic Acid	2	2	2	1	2	4	X
Gasoline	1	1	4	1	4	4	4
Gelatin	1	1	1	1	1	4	1
Girling Brake Fluid	3	3	1	4	2	X	X
Glauber's Salt	4	4	2	1	2	4	X
Gluconic Acid	3	3	1	3	1	4	2
Glucose	1	1	1	1	1	X	1
Glutamic Acid	3	3	1	3	1	4	2
Glycerine (Glycerol)	1	1	1	1	1	4	1
Glycerol Dichlorohydrin	3	3	1	3	1	4	2
Glycerol Monochlorohydrin	3	3	1	3	1	4	2
Glycerol Triacetate	3	3	1	3	1	4	2
Glycerophosphoric Acid	3	3	1	3	1	4	2
Glyceryl Phosphate	3	3	1	3	1	4	2
Glycidol	3	3	1	3	1	4	2
Glycolic Acid	3	3	1	3	1	4	2
Glycols	1	1	1	1	1	4	1
Glycoxylic Acid	3	3	1	3	1	4	2
Grease Petroleum Base	1	1	4	1	3	1	4
Green Sulfate Liquor	2	2	1	1	2	4	X
Gulf Endurance Oils	1	1	4	1	2	1	4
Gulf FR Fluids (Emulsion)	1	1	4	1	2	1	4
Gulf FR G-Fluids	1	1	1	1	1	4	1
Gulf FR P-Fluids	4	4	2	2	4	4	1
Gulf Harmony Oils	1	1	4	1	2	1	4
Gulf High Temperature Grease	1	1	4	1	2	1	4
Gulf Legion Oils	1	1	4	1	2	1	4
Gulf Paramount Oils	1	1	4	1	2	1	4
Gulf Security Oils	1	1	4	1	2	1	4
Gulfcrown Grease	1	1	4	1	2	1	4
H							
Halothane	4	4	4	1	4	4	4
Halowax Oil	4	4	4	1	4	X	4
Hannifin Lube A	1	1	4	1	1	1	2
Heavy Water	1	1	1	X	2	4	1
HEF-2 (High Energy Fuel)	2	2	4	1	4	4	4
Helium	1	1	1	1	1	1	1
Heptachlor	2	2	4	1	4	4	X
Heptachlorobutene	2	2	4	1	4	4	X
Heptaldehyde (Heptanal)	1	1	4	1	2	1	2
Heptane or n-Heptane	1	1	4	1	2	1	4
Heptanoic Acid	1	1	4	1	2	1	2
Hexachloroacetone	3	3	1	3	1	4	2
Hexachlorobutadiene	2	2	4	1	4	4	X
Hexachlorobutene	2	2	4	1	4	4	X
Hexachloroethane	2	2	4	1	4	4	X
Hexaldehyde or n-Hexaldehyde	4	4	1	4	1	X	2
Hexamethylene (Cyclohexane)	1	1	4	1	2	1	2
Hexamethylene Diammonium Adipate	2	2	4	1	4	4	X
Hexamethylenediamine	3	3	1	3	1	4	2
Hexamethylenetetramine	3	3	1	3	1	4	2
Hexane or n-Hexane	1	1	4	1	2	1	4
Hexene-1 or n-Hexene-1	2	2	4	1	2	1	4
Hexone (Methyl Isobutyl Ketone)	3	3	1	3	1	4	2
Hexyl Acetate	1	1	4	1	2	1	2

COMPOUND COMPATIBILITY RATING 1 — Satisfactory 2 — Fair (usually OK for static seal) 3 — Doubtful (sometimes OK for static seal) 4 — Unsatisfactory X — Insufficient Data	Nitrile NBR	Hydrogenated Nitrile HNBR	Ethylene Propylene EPDM	Fluorocarbon FKM	Neoprene/Chloroprene CR	Polyacrylate ACM	Silicone MQ, VMQ, PVMQ
Hexylene Glycol	3	3	1	3	1	4	2
Hexylresorcinol	2	2	4	1	4	4	X
High Viscosity Lubricant, H2	1	1	1	1	2	4	1
High Viscosity Lubricant, U4	1	1	1	1	2	4	1
HiLo MS #1	4	4	1	4	4	4	3
Houghto-Safe 1010 phosphate ester	4	4	1	1	4	4	3
Houghto-Safe 1055 phosphate ester	4	4	1	1	4	4	3
Houghto-Safe 1120 phosphate ester	4	4	2	1	4	4	3
Houghto-Safe 271 (Water & Glycol Base)	1	1	1	2	2	4	2
Houghto-Safe 416 & 500 Series	1	1	1	X	X	X	X
Houghto-Safe 5040 (Water/Oil emulsion)	1	1	4	1	2	4	3
Houghto-Safe 620 Water/Glycol	1	1	1	2	2	4	2
Hydraulic Oil (Petroleum Base, Industrial)	1	1	4	1	2	1	2
Hydraulic Oils (Synthetic Base)	2	2	4	1	4	4	X
Hydrazine	2	2	1	4	2	X	2
Hydrazine (Anhydrous)	4	4	2	4	2	4	X
Hydrazine Dihydrochloride	3	3	1	3	1	4	2
Hydrazine Hydrate	3	3	1	3	1	4	2
Hydriodic Acid	2	2	4	1	4	4	X
Hydrobromic Acid	4	4	1	1	4	4	4
Hydrobromic Acid 40%	4	4	1	1	2	4	4
Hydrocarbons, Saturated	1	1	4	1	2	1	4
Hydrochloric Acid (cold) 37%	4	X	3	1	4	X	X
Hydrochloric Acid (hot) 37%	4	X	3	1	4	4	X
Hydrochloric Acid, 3 Molar to 158 °F	2	2	1	1	2	3	4
Hydrochloric Acid, Concentrated Room Temp.	2	2	2	1	X	X	X
Hydrochloric Acid, Concentrated to 158 °F	4	4	4	1	4	4	4
Hydrocyanic Acid	2	2	1	1	2	4	3
Hydro-Drive MIH-10 (Petroleum Base)	1	1	4	1	2	1	2
Hydro-Drive MIH-50 (Petroleum Base)	1	1	4	1	2	1	2
Hydrofluoric Acid (conc.) Hot	4	X	4	3	X	X	X
Hydrofluorosilicic Acid	2	2	1	1	2	X	4
Hydrogen Chloride gas	4	X	1	1	2	X	X
Hydrogen Fluoride (Anhydrous)	4	4	1	4	X	4	X
Hydrogen Gas, Cold	1	1	1	1	1	2	3
Hydrogen Gas, Hot	1	1	1	1	1	2	3
Hydrogen Peroxide	2	2	1	1	1	4	1
Hydrogen Peroxide 90%	4	4	3	1	4	4	2
Hydrogen Sulfide, Dry, Cold	1	1	1	4	1	4	3
Hydrogen Sulfide, Dry, Hot	4	4	1	4	2	4	3
Hydrogen Sulfide, Wet, Cold	4	4	1	4	1	4	3
Hydrogen Sulfide, Wet, Hot	4	4	1	4	2	4	3
Hydrolube-Water/Ethylene Glycol	1	1	1	1	2	4	2
Hydroxycitronellal	X	X	X	1	4	4	X
Hydroquinol	4	4	4	1	4	X	X
Hydroquinone	3	3	2	2	4	4	X
Hydroxyacetic Acid	3	3	1	3	1	4	2
Hydrene	2	2	1	4	2	4	4
Hynet	4	4	1	4	4	X	X
Hynet IV and IVA	4	4	1	4	4	4	4
Hynet S4	4	X	1	4	4	X	X
Hynet W	4	4	1	4	4	X	X
Hypochlorous Acid	4	4	2	1	4	4	X
I							
Indole	X	X	X	1	4	4	X
Industron FF44	1	1	4	1	2	1	4
Industron FF48	1	1	4	1	2	1	4

03/03/06



COMPOUND COMPATIBILITY RATING 1 — Satisfactory 2 — Fair (usually OK for static seal) 3 — Doubtful (sometimes OK for static seal) 4 — Unsatisfactory X — Insufficient Data							
	Nitrile NBR	Hydrogenated Nitrile HNBR	Ethylene Propylene EPDM	Fluorocarbon FKM	Neoprene/Chloroprene CR	Polyacrylate ACM	Silicone MQ, VMQ, PVMQ
Industron FF53	1	1	4	1	2	1	4
Industron FF80	1	1	4	1	2	1	4
Insulin	3	3	1	3	1	4	2
Iodic Acid	3	3	1	3	1	4	2
Iodine	2	2	2	1	4	X	X
Iodine Pentafluoride	4	4	4	4	4	4	4
Iodoform	X	X	4	1	4	4	X
Isoamyl Acetate	3	3	1	3	1	4	2
Isoamyl Butyrate	3	3	1	3	1	4	2
Isoamyl Valerate	3	3	1	3	1	4	2
Isoboreol	X	X	X	1	4	4	X
Isobutane	1	1	4	1	2	1	2
Isobutyl Acetate	3	3	1	3	1	4	2
Isobutyl Alcohol	2	2	1	1	1	4	1
Isobutyl Chloride	4	4	4	1	4	X	X
Isobutyl Ether	2	2	4	4	3	X	X
Isobutyl Methyl Ketone	3	3	1	3	1	4	2
Isobutyl n-Butyrate	4	4	1	1	4	4	X
Isobutyl Phosphate	3	3	1	3	1	4	2
Isobutylene	X	X	X	1	4	4	X
Isobutyraldehyde	3	2	2	4	3	X	X
Isobutyric Acid	1	1	2	4	4	X	2
Isocrotyl Chloride	X	X	X	1	4	4	X
Isodecanol	1	1	4	1	2	1	2
Isododecane	1	1	4	1	2	4	4
Isoeugenol	1	1	4	1	2	1	2
Isooctane	1	1	4	1	2	1	4
Isopentane	1	1	4	1	2	1	2
Isophorone (Ketone)	4	4	2	4	4	4	4
Isopropanol	2	2	1	2	4	1	
Isopropyl Acetate	4	4	2	4	4	4	4
Isopropyl Alcohol	2	2	1	1	2	4	1
Isopropyl Chloride	4	4	4	1	4	4	4
Isopropyl Ether	2	2	4	4	3	3	4
Isopropylacetone	3	3	1	3	1	4	2
Isopropylamine	3	3	1	3	1	4	2
J							
Jet Fuel A	2	2	4	1	4	4	X
JP-10	3	3	4	1	4	4	4
JP-3 (MIL-J-5624)	1	1	4	1	4	X	X
JP-4 (MIL-T-5624)	1	1	4	1	4	2	4
JP-5 (MIL-T-5624)	1	1	4	1	4	2	4
JP-6 (MIL-J-25656)	1	1	4	1	4	2	4
JP-8 (MIL-T-83133)	1	1	4	1	3	1	4
JP-9 (MIL-F-81912)	3	3	4	1	4	4	4
JP-9 -11	4	4	4	1	4	4	4
JPX (MIL-F-25604)	1	1	4	4	2	X	X
K							
Kel F Liquids	1	1	1	2	X	X	1
Kerosene (Similar to RP-1 and JP-1)	1	1	4	1	2	1	4
Keystone #87HX-Grease	1	1	4	1	4	1	4
L							
Lacquer Solvents	4	4	4	4	4	4	4
Lacquers	4	4	4	4	4	4	4
Lactams-Amino Acids	4	4	2	4	2	X	X
Lactic Acid, Cold	1	1	1	1	1	4	1
Lactic Acid, Hot	4	4	4	1	4	4	2
Lactones (Cyclic Esters)	4	4	2	4	4	4	2

COMPOUND COMPATIBILITY RATING 1 — Satisfactory 2 — Fair (usually OK for static seal) 3 — Doubtful (sometimes OK for static seal) 4 — Unsatisfactory X — Insufficient Data							
	Nitrile NBR	Hydrogenated Nitrile HNBR	Ethylene Propylene EPDM	Fluorocarbon FKM	Neoprene/Chloroprene CR	Polyacrylate ACM	Silicone MQ, VMQ, PVMQ
Lard Animal Fat	1	1	2	1	2	1	2
Lauric Acid	1	1	4	1	2	1	2
Lavender Oil	2	2	4	1	4	X	X
LB 135	1	1	1	1	1	X	X
Lead Acetate	2	2	1	4	2	4	4
Lead Arsenate	3	3	1	3	1	4	2
Lead Bromide	3	3	1	3	1	4	2
Lead Carbonate	3	3	1	3	1	4	2
Lead Chloride	3	3	1	3	1	4	2
Lead Chromate	3	3	1	3	1	4	2
Lead Dioxide	3	3	1	3	1	4	2
Lead Linoleate	3	3	1	3	1	4	2
Lead Nitrate	1	1	1	X	1	X	2
Lead Oxide	3	3	1	3	1	4	2
Lead Sulfamate	2	2	1	1	1	4	2
Lehigh X1169	1	1	4	1	2	1	4
Lehigh X1170	1	1	4	1	2	1	4
Light Grease	1	1	4	1	4	X	X
Ligroin (Petroleum Ether or Benzene)	1	1	4	1	2	1	4
Lime Bleach	1	1	1	1	1	X	X
Lime Sulfur	X	X	X	1	4	4	X
Lindol, Hydraulic Fluid (Phosphate ester type)	4	4	1	2	4	4	3
Linoleic Acid	2	2	4	2	2	X	2
Linseed Oil	1	1	3	1	3	1	1
Liquid Oxygen (LOX)	4	4	4	4	4	4	4
Liquid Petroleum Gas (LPG)	1	1	4	1	2	3	3
Liquimoly	1	1	4	1	2	1	4
Lithium Bromide (Brine)	3	3	1	3	1	4	2
Lithium Carbonate	3	3	1	3	1	4	2
Lithium Chloride	3	3	1	3	1	4	2
Lithium Citrate	3	3	1	3	1	4	2
Lithium Hydroxide	3	3	1	3	1	4	2
Lithium Hypochlorite	3	3	1	3	1	4	2
Lithium Nitrate	3	3	1	3	1	4	2
Lithium Nitrite	3	3	1	3	1	4	2
Lithium Perchlorate	3	3	1	3	1	4	2
Lithium Salicylate	3	3	1	3	1	4	2
Lithopone	3	3	1	3	1	4	2
Lubricating Oils (Crude & Refined)	2	2	4	1	3	X	X
Lubricating Oils (Synthetic base)	X	X	X	1	4	4	X
Lubricating Oils, Di-ester	2	2	4	1	3	2	4
Lubricating Oils, petroleum base	1	1	4	1	2	1	4
Lubricating Oils, SAE 10, 20, 30, 40, 50	1	1	4	1	2	1	4
Lye Solutions	2	2	1	2	2	4	2
M							
Magnesium Chloride	1	1	1	1	1	X	1
Magnesium Hydroxide	2	2	1	1	2	4	X
Magnesium Salts	1	1	1	1	1	1	1
Magnesium Sulfite and Sulfate	1	1	1	1	1	4	1
Malathion	2	2	4	1	X	X	4
Maleic Acid	4	4	4	1	4	4	X
Maleic Anhydride	4	4	2	4	4	4	X
Maleic Hydrazide	3	3	1	3	1	4	2
Malic Acid	1	1	2	1	2	4	2
Mandelic Acid	3	3	1	3	1	4	2
Manganese Acetate	3	3	1	3	1	4	2
Manganese Carbonate	3	3	1	3	1	4	2
Manganese Chloride	3	3	1	3	1	4	2



Chemical Compatibility

COMPOUND COMPATIBILITY RATING 1 — Satisfactory 2 — Fair (usually OK for static seal) 3 — Doubtful (sometimes OK for static seal) 4 — Unsatisfactory X — Insufficient Data	Nitrile NBR	Hydrogenated Nitrile HNBR	Ethylene Propylene EPDM	Fluorocarbon FKM	Neoprene/Chloroprene CR	Polyacrylate ACM	Silicone MQ, VMQ, PVMQ
Manganese Gluconate	3	3	1	3	1	4	2
Manganese Hypophosphite	3	3	1	3	1	4	2
Manganese Linoleate	3	3	1	3	1	4	2
Manganese Phosphate	3	3	1	3	1	4	2
Manganese Sulfate	3	3	1	3	1	4	2
Manganous Chloride	3	3	1	3	1	4	2
Manganous Phosphate	3	3	1	3	1	4	2
Manganous Sulfate	3	3	1	3	1	4	2
Mannitol	3	3	1	3	1	4	2
MCS 312	4	4	4	1	4	4	1
MCS 352	4	4	1	4	4	4	3
MCS 463	4	4	1	4	4	4	3
MDI (Methylene di-p-phenylene isocyanate)	3	3	1	3	1	4	2
Mercaptan	1	1	4	1	2	1	2
Mercaptobenzothiazole (MBT)	X	X	X	1	4	4	X
Mercuric Acetate	3	3	1	3	1	4	2
Mercuric Chloride	1	1	1	1	1	X	X
Mercuric Cyanide	3	3	1	3	1	4	2
Mercuric Iodide	3	3	1	3	1	4	2
Mercuric Nitrate	3	3	1	3	1	4	2
Mercuric Sulfate	3	3	1	3	1	4	2
Mercuric Sulfite	3	3	1	3	1	4	2
Mercurous Nitrate	3	3	1	3	1	4	2
Mercury	1	1	1	1	1	X	X
Mercury Chloride	3	3	1	3	1	4	2
Mercury Fulminate	3	3	1	3	1	4	2
Mercury Salts	3	3	1	3	1	4	2
Mercury Vapors	1	1	1	1	1	X	X
Mesityl Oxide (Ketone)	4	4	2	4	4	4	4
Meta-Cresol	X	X	X	1	4	4	X
Metalddehyde	3	3	1	3	1	4	2
Meta-Nitroaniline	3	3	1	3	1	4	2
Meta-Toluidine	X	X	X	1	4	4	X
Methacrylic Acid	3	3	1	3	1	4	2
Methallyl Chloride	X	X	X	1	4	4	X
Methane	1	1	4	1	2	1	4
Methanol	4	4	1	4	1	4	1
Methoxyethanol (DGMMA)	3	3	1	3	1	4	2
Methyl Abietate	X	X	X	1	4	4	X
Methyl Acetate	4	4	2	4	2	4	4
Methyl Acetoacetate	4	4	2	4	4	4	2
Methyl Acetophenone*	X	X	X	1	4	4	X
Methyl Acrylate	4	4	2	4	2	4	4
Methyl Alcohol	4	4	1	4	1	4	1
Methyl Amylketone	3	3	1	3	1	4	2
Methyl Anthranilate	X	X	X	1	4	4	X
Methyl Benzoate	4	4	4	1	4	4	4
Methyl Bromide	2	2	4	1	4	3	X
Methyl Butyl Ketone	4	4	1	4	4	4	4
Methyl Butyrate Cellosolve	3	3	1	3	1	4	2
Methyl Butyrate Chloride	3	3	1	3	1	4	2
Methyl Carbonate	4	4	4	1	4	4	4
Methyl Cellosolve	3	3	2	4	3	4	4
Methyl Cellulose	2	2	2	4	2	4	2
Methyl Chloride	4	4	3	1	4	4	4
Methyl Chloroacetate	3	3	1	3	1	4	2
Methyl Chloroform	4	4	4	1	4	X	X

COMPOUND COMPATIBILITY RATING 1 — Satisfactory 2 — Fair (usually OK for static seal) 3 — Doubtful (sometimes OK for static seal) 4 — Unsatisfactory X — Insufficient Data	Nitrile NBR	Hydrogenated Nitrile HNBR	Ethylene Propylene EPDM	Fluorocarbon FKM	Neoprene/Chloroprene CR	Polyacrylate ACM	Silicone MQ, VMQ, PVMQ
Methyl Cyanide (Acetonitrile)	3	3	1	3	1	4	2
Methyl Cyclohexanone	1	1	4	1	2	1	2
Methyl Dichloride	X	X	X	1	4	4	X
Methyl Ether	1	1	4	1	3	4	1
Methyl Ethyl Ketone (MEK)	4	4	1	4	4	4	4
Methyl Ethyl Ketone Peroxide	4	4	4	4	4	4	2
Methyl Ethyl Oleate	X	X	X	1	4	4	X
Methyl Formate	4	4	2	X	2	X	X
Methyl Hexyl Ketone (2-Octanone)	3	3	1	3	1	4	2
Methyl Iodide	1	1	4	1	2	1	2
Methyl Isobutyl Ketone (MIBK)	4	4	3	4	4	4	4
Methyl Isocyanate	3	3	1	3	1	4	2
Methyl Isopropyl Ketone	4	4	2	4	4	4	4
Methyl Isovalerate	X	X	X	1	4	4	X
Methyl Lactate	3	3	1	3	1	4	2
Methyl Mercaptan	X	X	1	X	X	X	X
Methyl Methacrylate	4	X	4	4	4	4	4
Methyl Oleate	4	4	2	1	4	X	X
Methyl Pentadiene	X	X	X	1	4	4	X
Methyl Phenylacetate	X	X	X	1	4	4	X
Methyl Salicylate	4	4	2	X	4	X	X
Methyl Tertiary Butyl Ether (MTBE)	3	3	3	3	3	X	X
Methyl Valerate	X	X	X	1	4	4	X
Methyl-2-Pyrrolidone or n-Methyl-2-Pyrrolidone	X	X	2	X	X	X	X
Methylacrylic Acid	4	4	2	3	2	4	4
Methylamine	3	3	1	3	1	4	2
Methylamyl Acetate	3	3	1	3	1	4	2
Methylcyclopentane	4	4	4	1	4	4	4
Methylene Bromide	X	X	X	1	4	4	X
Methylene Chloride	4	4	4	2	4	4	4
Methylene Iodide	X	X	X	1	4	4	X
Methylglycerol	3	3	1	3	1	4	2
Methylisobutyl Carbinol	1	1	4	1	2	1	2
Methylpyrrolidone	X	X	X	1	4	4	X
Methylpyrrolidone	X	X	X	1	4	4	X
Methylsulfuric Acid	3	3	1	3	1	4	2
MIL-A-6091	2	2	1	1	1	4	1
MIL-C-4339	1	1	4	1	4	1	3
MIL-C-7024	1	1	4	1	2	2	4
MIL-C-8188	2	2	4	2	4	3	4
MIL-E-9500	1	1	1	1	1	4	1
MIL-F-16884	1	1	4	1	3	1	4
MIL-F-17111	1	1	4	1	2	1	4
MIL-F-25558 (RJ-1)	1	1	4	1	2	1	4
MIL-F-25656	1	1	4	1	4	2	4
MIL-F-5566	2	2	1	1	2	4	1
MIL-F-81912 (JP-9)	3	3	4	1	4	4	4
MIL-F-82522 (RJ-4)	2	2	4	1	4	1	4
MIL-G-10924	1	1	4	1	2	2	4
MIL-G-15793	1	1	4	1	2	1	4
MIL-G-21568	1	1	1	1	1	1	4
MIL-G-25013	1	1	1	1	2	1	4
MIL-G-25537	1	1	4	1	2	2	4
MIL-G-25760	2	2	4	1	2	2	4
MIL-G-3278	2	2	4	1	4	1	4
MIL-G-3545	1	1	4	1	2	1	4
MIL-G-4343	2	2	3	1	2	1	3

03/03/06



Chemical Compatibility

COMPOUND COMPATIBILITY RATING 1 — Satisfactory 2 — Fair (usually OK for static seal) 3 — Doubtful (sometimes OK for static seal) 4 — Unsatisfactory X — Insufficient Data							
	Nitrile NBR	Hydrogenated Nitrile HNBR	Ethylene Propylene EPDM	Fluorocarbon FKM	Neoprene/Chloroprene CR	Polyacrylate ACM	Silicone MQ, VMQ, PVMQ
MIL-G-5572	1	1	4	1	4	2	4
MIL-G-7118	2	2	4	1	2	3	4
MIL-G-7187	1	1	4	1	4	1	4
MIL-G-7421	2	2	4	1	2	4	4
MIL-G-7711	1	1	4	1	4	2	2
MIL-H-13910	1	1	1	1	1	2	4
MIL-H-19457	4	4	2	1	4	4	3
MIL-H-22251	2	2	1	X	2	X	4
MIL-H-27601	1	1	4	1	2	1	4
MIL-H-46170 -15 to +400 °F	1	1	4	1	2	2	4
MIL-H-46170 -20 to +275 °F	1	1	4	1	2	2	4
MIL-H-46170 -55 to +275 °F	1	1	4	1	2	2	4
MIL-H-46170 -65 to +275 °F	1	1	4	1	2	2	4
MIL-H-5606 -65 to +235 °F	1	1	4	1	2	2	4
MIL-H-5606 -65 to +275 °F	1	1	4	1	2	2	4
MIL-H-6083	1	1	4	1	1	1	4
MIL-H-7083	1	1	1	2	2	4	1
MIL-H-8446 (MLO-8515)	2	2	4	1	1	3	4
MIL-J-5161	2	2	4	1	4	1	4
Milk	1	1	1	1	1	4	1
MIL-L-15016	1	1	4	1	2	1	4
MIL-L-15017	1	1	4	1	2	1	4
MIL-L-17331	1	1	4	1	X	X	4
MIL-L-2104	1	1	4	1	2	1	4
MIL-L-21260	1	1	4	1	2	1	4
MIL-L-23699	2	2	4	1	3	3	4
MIL-L-25681	2	2	1	1	2	2	4
MIL-L-3150	1	1	4	1	2	2	4
MIL-L-6081	1	1	4	1	2	1	4
MIL-L-6082	1	1	4	1	2	1	3
MIL-L-6085	2	2	4	1	4	2	4
MIL-L-6387	2	2	4	1	4	2	4
MIL-L-7808	2	2	4	1	4	2	4
MIL-L-7870	1	1	4	1	2	1	4
MIL-L-9000	1	1	4	1	2	1	4
MIL-L-9236	2	2	4	1	4	2	4
MIL-O-3503	1	1	4	1	2	2	4
MIL-P-27402	2	2	1	X	2	X	4
MIL-R-25576 (RP-1)	1	1	4	1	2	1	4
MIL-S-3136, Type I Fuel	1	1	4	1	2	1	4
MIL-S-3136, Type II Fuel	2	2	4	1	4	3	4
MIL-S-3136, Type III Fuel	2	2	4	1	4	3	4
MIL-S-3136, Type IV Oil High Swell	1	1	4	1	4	1	2
MIL-S-3136, Type IV Oil Low Swell	1	1	4	1	1	1	3
MIL-S-3136, Type V Oil Medium Swell	1	1	4	1	2	1	2
MIL-S-81087	1	1	1	1	1	1	3
MIL-T-5624, JP-4, JP-5	1	1	4	1	4	2	4
MIL-T-83133	1	1	4	1	3	1	4
Mineral Oils	1	1	3	1	2	1	2
Mixed Acids	3	3	1	3	1	4	2
MLO-7277 Hydr.	3	3	4	1	4	3	4
MLO-7557	3	3	4	1	4	3	4
MLO-8200 Hydr.	2	2	4	1	1	X	4
MLO-8515	2	2	4	1	1	3	4
Mobil 24dte	1	1	4	1	2	X	X
Mobil Delvac 1100, 1110, 1120, 1130	1	1	4	1	2	X	X
Mobil HF	1	1	4	1	2	X	X
Mobil Nivac 20, 30	1	1	1	1	1	X	X

COMPOUND COMPATIBILITY RATING 1 — Satisfactory 2 — Fair (usually OK for static seal) 3 — Doubtful (sometimes OK for static seal) 4 — Unsatisfactory X — Insufficient Data							
	Nitrile NBR	Hydrogenated Nitrile HNBR	Ethylene Propylene EPDM	Fluorocarbon FKM	Neoprene/Chloroprene CR	Polyacrylate ACM	Silicone MQ, VMQ, PVMQ
Mobil SHC 500 Series	3	3	4	1	2	1	2
Mobil SHC 600 Series	3	3	4	1	2	1	3
Mobil Therm 600	1	1	4	1	2	X	X
Mobil Velocite c	1	1	4	1	2	X	X
Mobilgas WA200 ATF	1	1	4	1	2	X	X
Mobilgear 600 Series	3	3	3	1	1	1	1
Mobilgear SHC ISO Series	3	3	3	1	2	1	1
Mobilgrease HP	2	2	4	1	2	1	2
Mobilgrease HTS	2	2	4	1	2	1	2
Mobilgrease SM	2	2	4	1	2	1	2
Mobilith AW Series	2	2	4	1	2	1	2
Mobilith SHC Series	2	2	4	1	3	1	2
Mobilistube Series	3	3	3	1	1	1	1
Mobiloil SAE 20	1	1	4	1	2	X	X
Mobilux	1	1	4	1	2	X	X
Molybdenum Disulfide Grease	1	X	4	1	4	X	X
Molybdenum Oxide	3	3	1	3	1	4	2
Molybdenum Trioxide	3	3	1	3	1	4	2
Molybdic Acid	3	3	1	3	1	4	2
Monobromobenzene	4	4	4	1	4	4	4
Monobromotoluene	X	X	X	1	4	4	X
Monochloroacetic Acid	3	3	1	3	1	4	2
Monochlorobenzene	4	4	4	1	4	4	4
Monochlorobutene	X	X	X	1	4	4	X
Monoethanolamine (MEA)	4	4	2	4	4	4	2
Monoethyl Amine	3	3	1	3	1	4	2
Monoisopropylamine	3	3	1	3	1	4	2
Monomethyl Aniline	4	X	1	2	1	4	2
Monomethyl Ether (Methyl Ether)	1	X	4	1	X	X	X
Monomethyl Hydrazine	2	2	1	X	2	X	4
Monomethylamine (MMA)	3	3	1	3	1	4	2
Monomethylaniline	4	4	2	2	4	4	X
Mononitrotoluene	3	3	1	3	1	4	2
Mononitrotoluene & Dinitrotoluene (40/60 Mixture)	4	4	1	3	4	4	4
Monovinyl Acetylene	1	1	1	1	2	X	2
Mopar Brake Fluid	3	3	1	4	2	X	3
Morpholine	X	X	X	1	4	4	X
Motor Oils	1	1	4	1	2	1	2
Myristic Acid	X	X	X	1	4	4	X
N							
Naphthalene	4	4	4	1	4	X	4
Naphthalene Chloride	X	X	X	1	4	4	X
Naphthalene Sulfonic Acid	X	X	X	1	4	4	X
Naphthalenic Acid	X	X	X	1	4	4	X
Naphthalonic Acid	X	X	X	1	4	4	X
Naphthenic Acid	2	2	4	1	4	X	4
Naptha	2	2	4	1	4	2	4
Natural Gas	1	1	4	1	1	2	4
Neatsfoot Oil	1	1	2	1	4	1	2
Neon	1	1	1	1	1	1	1
Neville Acid	4	4	2	1	4	4	4
Nickel Acetate	2	2	1	4	2	4	4
Nickel Ammonium Sulfate	3	3	1	3	1	4	2
Nickel Chloride	1	1	1	1	2	3	1
Nickel Cyanide	3	3	1	3	1	4	2
Nickel Nitrate	3	3	1	3	1	4	2
Nickel Salts	1	1	1	1	2	3	1
Nickel Sulfate	1	1	1	1	1	4	1



03/03/06



Chemical Compatibility

COMPOUND COMPATIBILITY RATING 1 — Satisfactory 2 — Fair (usually OK for static seal) 3 — Doubtful (sometimes OK for static seal) 4 — Unsatisfactory X — Insufficient Data	Nitrile NBR	Hydrogenated Nitrile HNBR	Ethylene Propylene EPDM	Fluorocarbon FKM	Neoprene/Chloroprene CR	Polyacrylate ACM	Silicone MQ, VMQ, PVMQ
Nicotinamide Hydrochloride	3	3	1	3	1	4	2
Nicotine	X	X	X	1	4	4	X
Nicotine Sulfate	3	3	1	3	1	4	2
Niter Cake	1	1	1	1	1	4	1
Nitric Acid, Red Fuming	4	4	4	2	4	X	X
Nitric Acid (0 – 50%)	4	X	2	1	X	X	X
Nitric Acid (50 – 100%)	4	X	4	3	X	X	X
Nitric Acid 3 Molar to 158 °F	4	4	2	3	4	4	4
Nitric Acid Concentrated Room Temp.	X	X	4	2	X	X	X
Nitric Acid Concentrated to 158 °F	4	4	4	4	4	4	4
Nitroaniline	3	3	1	3	1	4	2
Nitrobenzene	4	4	1	2	4	4	4
Nitrobenzoic Acid	3	3	1	3	1	4	2
Nitrocellulose	3	3	1	3	1	4	2
Nitrochlorobenzene	3	3	1	3	1	4	2
Nitrochloroform	3	3	1	3	1	4	2
Nitrodiethylaniline	3	3	1	3	1	4	2
Nitroethane	4	4	2	4	2	4	4
Nitrofluorobenzene	3	3	1	3	1	4	2
Nitrogen	1	1	1	1	1	1	1
Nitrogen Oxides	3	3	1	3	1	4	2
Nitrogen Tetroxide (N ₂ O ₄)	4	3	4	4	4	4	4
Nitroglycerine	3	3	1	3	1	4	2
Nitroglycerol	3	3	1	3	1	4	2
Nitroisopropylbenzene	3	3	1	3	1	4	2
Nitromethane	4	4	2	4	3	4	4
Nitrophenol	3	3	1	3	1	4	2
Nitropropane	4	4	2	4	4	4	4
Nitrothiophene	3	3	1	3	1	4	2
Nitrotoluene	3	3	1	3	1	4	2
Nitrous Acid	3	3	1	3	1	4	2
Nitrous Oxide	1	1	1	1	X	X	1
Nonane	1	1	4	1	2	1	2
Noryl GE Phenolic	1	1	1	X	X	X	X
Nyvac FR200 Mobil	1	1	1	1	2	X	X
O							
Octachloro Toluene	4	4	4	1	4	4	4
Octadecane	1	1	4	1	2	2	4
Octanal (n-Octanaldehyde)	1	1	4	1	2	1	2
Octane or n-Octane	1	1	4	1	4	4	4
Octyl Acetate	3	3	1	3	1	4	2
Octyl Alcohol	2	2	3	1	2	4	2
Octyl Chloride	1	1	4	1	2	1	2
Octyl Phthalate	X	X	X	1	4	4	X
Olefins	X	X	X	1	4	4	X
Oleic Acid	3	3	4	2	4	4	4
Oleum (Fuming Sulfuric Acid)	4	4	4	1	4	4	4
Oleum Spirits	2	2	4	1	3	X	4
Oleyl Alcohol	X	X	X	1	4	4	X
Olive Oil	1	1	2	1	2	1	3
Oronite 8200	2	2	4	1	1	X	4
Oronite 8515	2	2	4	1	1	X	4
Ortho-Chloro Ethyl Benzene	4	4	4	1	4	4	4
Ortho-Chloroaniline	3	3	1	3	1	4	2
Ortho-Chlorophenol	3	3	1	3	1	4	2
Ortho-Cresol	3	3	1	3	1	4	2
Ortho-Dichlorobenzene	4	4	4	1	4	4	4

COMPOUND COMPATIBILITY RATING 1 — Satisfactory 2 — Fair (usually OK for static seal) 3 — Doubtful (sometimes OK for static seal) 4 — Unsatisfactory X — Insufficient Data	Nitrile NBR	Hydrogenated Nitrile HNBR	Ethylene Propylene EPDM	Fluorocarbon FKM	Neoprene/Chloroprene CR	Polyacrylate ACM	Silicone MQ, VMQ, PVMQ
OS 45 Type III (OS45)	2	2	4	1	1	X	4
OS 45 Type IV (OS45-1)	2	2	4	1	1	X	4
OS 70	2	2	4	1	1	X	4
Oxalic Acid	2	2	1	1	2	X	2
Oxygen, 200 – 300 °F (Evaluate for specific applications)	4	4	4	2	X	X	X
Oxygen, 300 – 400 °F (Evaluate for specific applications)	4	4	4	2	4	4	1
Oxygen, Cold (Evaluate for specific applications)	2	2	1	1	1	2	1
Oxygen, Liquid	4	4	4	4	4	X	X
Ozonated Deionized Water	3	3	1	3	1	4	2
Ozone	4	4	1	1	2	2	1
P							
Paint Thinner, Duco	4	4	4	2	4	4	4
Palmitic Acid	1	1	2	1	2	X	4
Para-Aminobenzoic Acid	3	3	1	3	1	4	2
Para-Aminosalicylic Acid	3	3	1	3	1	4	2
Para-Chlorophenol	3	3	1	3	1	4	2
Paracymene	X	X	X	1	4	4	X
Para-Dichlorobenzene	4	4	4	1	4	4	4
Paraffins	1	1	4	1	2	1	2
Para-Formaldehyde	3	3	1	3	1	4	2
Paraaldehyde	3	3	1	3	1	4	2
Par-al-Ketone	4	4	4	4	4	4	4
Para-Nitroaniline	3	3	1	3	1	4	2
Para-Nitrobenzoic Acid	3	3	1	3	1	4	2
Para-Nitrophenol	3	3	1	3	1	4	2
Parathion	X	X	X	1	4	4	X
Para-Toluene Sulfonic Acid	3	3	1	3	1	4	2
Parker O Lube	1	1	4	1	1	1	2
Peanut Oil	1	1	3	1	3	1	1
Pectin (Liquor)	X	X	X	1	4	4	X
Penicillin (Liquid)	X	X	X	1	4	4	X
Pentachloroethane	X	X	X	1	4	4	X
Pentachlorophenol	3	3	1	3	1	4	2
Pentaerythritol	3	3	1	3	1	4	2
Pentaerythritol Tetranitrate	3	3	1	3	1	4	2
Pentane or n-Pentane	1	1	4	1	1	1	4
Pentane, 2 Methyl	1	1	4	1	2	1	4
Pentane, 2-4 dimethyl	1	1	4	1	2	1	4
Pentane, 3-Methyl	1	1	4	1	2	1	4
Pentyl Pentanoate	1	1	4	1	2	1	2
Peracetic Acid	3	3	1	3	1	4	2
Perchloric Acid – 2N	4	4	1	1	2	4	2
Perchloroethylene	2	2	4	1	4	4	4
Petrolatum	1	1	4	1	2	1	4
Petrolatum Ether	1	1	4	1	2	1	2
Petroleum Oil, Above 250 °F	4	4	4	2	4	4	4
Petroleum Oil, Below 250 °F	1	1	4	1	2	2	2
Petroleum Oil, Crude	1	1	4	1	2	1	4
Phenol	4	4	4	1	4	4	4
Phenol, 70% / 30% H ₂ O	4	4	4	1	4	4	4
Phenol, 85% / 15% H ₂ O	4	4	4	1	4	4	4
Phenolic Sulfonate	3	3	1	3	1	4	2
Phenolsulfonic Acid	3	3	1	3	1	4	2
Phenylacetamide	X	X	X	1	4	4	X
Phenylacetate	3	3	1	3	1	4	2
Phenylacetic Acid	3	3	1	3	1	4	2
Phenylbenzene	4	4	4	1	4	4	4

03/03/06



Chemical Compatibility

COMPOUND COMPATIBILITY RATING 1 — Satisfactory 2 — Fair (usually OK for static seal) 3 — Doubtful (sometimes OK for static seal) 4 — Unsatisfactory X — Insufficient Data	Nitrile NBR	Hydrogenated Nitrile HNBR	Ethylene Propylene EPDM	Fluorocarbon FKM	Neoprene/Chloroprene CR	Polyacrylate ACM	Silicone MQ, VMQ, PVMQ
Phenylethyl Ether	4	4	4	4	4	4	4
Phenylethyl Malonic Ester*	X	X	X	1	4	4	X
Phenylglycerine	3	3	1	3	1	4	2
Phenylhydrazine	4	4	2	1	4	4	X
Phenylhydrazine Hydrochloride	3	3	1	3	1	4	2
Phenylmercuric Acetate	3	3	1	3	1	4	2
Phorone	4	4	3	4	4	4	4
Phosphoric Acid 3 Molar to 158 °F	1	1	1	1	2	3	2
Phosphoric Acid Concentrated Room Temp	2	2	1	1	2	2	3
Phosphoric Acid Concentrated to 158 °F	4	4	1	1	3	3	4
Phosphorus Trichloride	4	4	1	1	4	X	X
Phosphorus Trichloride Acid	4	4	1	1	4	X	X
Phthalic Acid	3	3	1	3	1	4	2
Phthalic Anhydride	3	3	1	3	1	4	2
Pickling Solution	4	4	3	2	4	4	4
Picric Acid (aq)	1	1	1	1	1	X	X
Picric Acid Molten	2	2	2	1	2	X	4
Pine Oil	1	1	4	1	4	X	4
Pine Tar	1	1	4	1	2	1	2
Pinene	2	2	4	1	3	4	4
Piperazine	X	X	X	1	4	4	X
Piperidine	4	4	4	1	4	4	4
Plating Solution (Co, Cu, Au, In, Fe, Pb, Ni, Ag, Sn, Zn)	1	1	1	1	X	X	X
Plating Solutions Chrome	4	4	2	1	4	4	2
Plating Solutions Others	1	1	1	1	4	X	4
Pneumatic Service	1	1	1	1	1	4	4
Polyethylene Glycol	2	2	1	3	2	X	X
Polyglycerol	3	3	1	3	1	4	2
Polyglycol	3	3	1	3	1	4	2
Polyvinyl Acetate Emulsion	X	X	1	X	2	X	X
Potassium Acetate	2	2	1	4	2	4	4
Potassium Acid Sulfate	3	3	1	3	1	4	2
Potassium Alum	3	3	1	3	1	4	2
Potassium Aluminum Sulfate	3	3	1	3	1	4	2
Potassium Antimonate	3	3	1	3	1	4	2
Potassium Bicarbonate	3	3	1	3	1	4	2
Potassium Bichromate	3	3	1	3	1	4	2
Potassium Bifluoride	3	3	1	3	1	4	2
Potassium Bisulfate	3	3	1	3	1	4	2
Potassium Bisulfite	3	3	1	3	1	4	2
Potassium Bitartrate	3	3	1	3	1	4	2
Potassium Bromide	3	3	1	3	1	4	2
Potassium Carbonate	3	3	1	3	1	4	2
Potassium Chlorate	3	3	1	3	1	4	2
Potassium Chloride	1	1	1	1	1	1	1
Potassium Chromates	3	3	1	3	1	4	2
Potassium Citrate	3	3	1	3	X	4	2
Potassium Cupro Cyanide	1	1	1	1	1	1	1
Potassium Cyanate	3	3	1	3	1	4	2
Potassium Cyanide	1	1	1	1	1	1	1
Potassium Dichromate	1	1	1	1	1	1	1
Potassium Diphosphate	3	3	1	3	1	4	2
Potassium Ferricyanide	3	3	1	3	1	4	2
Potassium Fluoride	3	3	1	3	1	4	2
Potassium Gluconate	3	3	1	3	1	4	2
Potassium Hydroxide 50%	2	2	1	4	2	4	3
Potassium Hypochlorite	3	3	1	3	1	4	2

COMPOUND COMPATIBILITY RATING 1 — Satisfactory 2 — Fair (usually OK for static seal) 3 — Doubtful (sometimes OK for static seal) 4 — Unsatisfactory X — Insufficient Data	Nitrile NBR	Hydrogenated Nitrile HNBR	Ethylene Propylene EPDM	Fluorocarbon FKM	Neoprene/Chloroprene CR	Polyacrylate ACM	Silicone MQ, VMQ, PVMQ
Potassium Iodide	3	3	1	3	1	4	2
Potassium Metabisulfate	3	3	1	3	1	4	2
Potassium Metachromate	3	3	1	3	1	4	2
Potassium Monochromate	3	3	1	3	1	4	2
Potassium Nitrate	1	1	1	1	1	1	1
Potassium Nitrite	3	3	1	3	1	4	2
Potassium Oxalate	3	3	1	3	1	4	2
Potassium Perchlorate	3	3	1	3	1	4	2
Potassium Permanganate	3	3	1	3	1	4	2
Potassium Persulfate	3	3	1	3	1	4	2
Potassium Phosphate (Acid)	3	3	1	3	1	4	2
Potassium Phosphate (Alkaline)	3	3	1	3	1	4	2
Potassium Phosphate (Di/Tri Basic)	3	3	1	3	1	4	2
Potassium Pyrosulfate	3	3	1	3	1	4	2
Potassium Salts	1	1	1	1	1	1	1
Potassium Sodium Tartrate	3	3	1	3	1	4	2
Potassium Stannate	3	3	1	3	1	4	2
Potassium Stearate	3	3	1	3	1	4	2
Potassium Sulfate	1	1	1	1	1	4	1
Potassium Sulfide	3	3	1	3	1	4	2
Potassium Sulfite	1	1	1	1	1	4	1
Potassium Tartrate	3	3	1	3	1	4	2
Potassium Thiocyanate	3	3	1	3	1	4	2
Potassium Thiosulfate	3	3	1	3	1	4	2
Potassium Triphosphate	3	3	1	3	1	4	2
Prestone Antifreeze	1	1	1	1	1	4	1
PRL-High Temp. Hydr. Oil	2	2	4	1	2	2	2
Producer Gas	1	1	4	1	2	2	2
Propane	1	1	4	1	2	1	4
Propionaldehyde	3	3	1	3	1	4	2
Propionic Acid	3	3	1	3	1	4	2
Propionitrile	1	1	4	1	2	X	X
Propyl Acetate	4	4	2	4	4	4	4
Propyl Acetone or n-Propyl Acetone	4	4	1	4	4	4	4
Propyl Alcohol	1	1	1	1	1	4	1
Propyl Nitrate	4	4	2	4	4	4	4
Propyl Propionate	3	3	1	3	1	4	2
Propylamine	3	3	1	3	1	4	2
Propylbenzene	X	X	X	1	4	4	X
Propylene	3	3	4	1	4	4	4
Propylene Chloride	X	X	X	1	4	4	X
Propylene Chlorohydrin	X	X	X	1	4	4	X
Propylene Dichloride	X	X	X	1	4	4	X
Propylene Glycol	3	3	1	3	1	4	2
Propylene Imine	X	X	X	1	4	4	X
Propylene Oxide	4	4	2	4	4	4	4
Pydraul 90e	4	4	1	1	4	X	X
Pydraul, 10E	4	4	1	4	4	4	1
Pydraul, 115E	4	4	1	1	4	4	4
Pydraul, 230C, 312C, 540C, A200	4	4	4	1	4	4	4
Pydraul, 29ELT 30E, 50E, 65E	4	4	1	1	4	4	1
Pyranol Transformer Oil	1	1	4	1	2	1	4
Pyridine	4	4	2	1	4	4	X
Pyridine Oil	4	4	2	4	4	4	4
Pyridine Sulfate	3	3	1	3	1	4	2
Pyridine Sulfonic Acid	3	3	1	3	1	4	2
Pyrogallol (Pyrogallic Acid)	2	2	4	1	4	4	X



03/03/06



Chemical Compatibility

COMPOUND COMPATIBILITY RATING 1 — Satisfactory 2 — Fair (usually OK for static seal) 3 — Doubtful (sometimes OK for static seal) 4 — Unsatisfactory X — Insufficient Data							
	Nitrile NBR	Hydrogenated Nitrile HNBR	Ethylene Propylene EPDM	Fluorocarbon FKM	Neoprene/Chloroprene CR	Polyacrylate ACM	Silicone MQ, VMQ, PVMQ
Pyrogard 42, 43, 55	4	4	1	1	4	X	X
Pyrogard 53, Mobil Phosphate Ester	4	4	1	1	4	4	4
Pyrogard D, Mobil Water-in-Oil Emulsion	1	1	4	4	2	X	3
Pyroligneous Acid	4	4	2	4	2	4	X
Pyrolube	4	4	2	1	4	4	2
Pyrosulfuric Acid	3	3	1	3	1	4	2
Pyrosulfuryl Chloride	2	2	4	1	4	4	X
Pyrrole	4	4	4	4	4	4	2
Pyruvic Acid	3	3	1	3	1	4	2
Q							
Quinidine	2	2	4	1	4	4	X
Quinine	2	2	4	1	4	4	X
Quinine Bisulfate	3	3	1	3	1	4	2
Quinine Hydrochloride	3	3	1	3	1	4	2
Quinine Sulfate	3	3	1	3	1	4	2
Quinine Tartrate	3	3	1	3	1	4	2
Quinizarin	2	2	4	1	4	4	X
Quinoline	2	2	4	1	4	4	X
Quinone	2	2	4	1	4	4	X
R							
Radiation (Gamma, 1.0 E+07 Rads)	3	3	2	4	X	X	2
Raffinate	2	2	4	1	4	4	X
Rapeseed Oil	2	2	1	1	2	2	4
Red Line 100 Oil	1	1	4	1	2	1	4
Red Oil (MIL-H-5606)	1	1	4	1	2	1	4
Resorcinol	3	3	1	3	1	4	2
Riboflavin	2	2	4	1	4	4	X
Ricinoleic Acid	2	2	4	1	4	4	X
RJ-1 (MIL-F-25558)	1	1	4	1	2	1	4
RJ-4 (MIL-F-82522)	2	2	4	1	4	2	4
Rosin	2	2	4	1	4	4	X
RP-1 (MIL-R-25576)	1	1	4	1	2	1	4
S							
Saccharin Solution	3	3	1	3	1	4	2
Sal Ammoniac	1	1	1	1	1	1	2
Salicylic Acid	2	2	1	1	X	X	X
Santo Safe 300	4	4	3	1	4	4	1
Sea (Salt) Water	1	1	1	1	2	4	1
Sebacic Acid	3	3	1	3	1	4	2
Selenic Acid	3	3	1	3	1	4	2
Selenous Acid	3	3	1	3	1	4	2
Sewage	1	1	1	1	2	4	1
SF 1154 GE Silicone Fluid	2	2	1	1	1	1	4
SF1147 GE Silicone Fluid	2	2	3	1	X	X	4
SF96 GE Silicone Fluid	2	2	1	1	1	1	4
Shell 3XF Mine Fluid (Fire resist hydr.)	1	1	4	1	2	4	X
Shell Alvania Grease #2	1	1	4	1	2	1	2
Shell Carnea 19 and 29	1	1	4	1	4	1	X
Shell Diala	1	1	4	1	2	1	4
Shell Iruis 905	1	1	4	1	2	1	4
Shell Lo Hydrax 27 and 29	1	1	4	1	2	1	4
Shell Macome 72	1	1	4	1	2	1	4
Shell Tellus #32 Pet. Base	1	1	4	1	2	1	4
Shell Tellus #68	1	1	4	1	2	1	4
Shell Tellus 27 (Petroleum Base)	1	1	4	1	2	X	X
Shell Tellus 33	1	1	4	1	2	X	X
Shell UMF (5% Aromatic)	1	1	4	1	2	1	4
Shellac	3	3	1	3	1	4	2

COMPOUND COMPATIBILITY RATING 1 — Satisfactory 2 — Fair (usually OK for static seal) 3 — Doubtful (sometimes OK for static seal) 4 — Unsatisfactory X — Insufficient Data							
	Nitrile NBR	Hydrogenated Nitrile HNBR	Ethylene Propylene EPDM	Fluorocarbon FKM	Neoprene/Chloroprene CR	Polyacrylate ACM	Silicone MQ, VMQ, PVMQ
Silicate Esters	2	2	4	1	1	X	4
Silicone Greases	1	1	1	1	1	1	3
Silicone Oils	1	1	1	1	1	1	3
Silver Bromide	3	3	1	3	1	4	2
Silver Chloride	3	3	1	3	1	4	2
Silver Cyanide	3	3	1	3	1	4	2
Silver Nitrate	2	2	1	1	1	1	1
Silver Sulfate	3	3	1	3	1	4	2
Sinclair Opaline CX-EP Lube	1	1	4	1	2	1	4
Skelly, Solvent B, C, E	1	1	4	1	4	X	X
Skydrol 500 B4	4	4	1	4	4	4	3
Skydrol 7000	4	4	1	2	4	X	X
Skydrol LD-4	4	4	1	4	4	4	3
Soap Solutions	1	1	1	1	2	4	1
Socony Mobile Type A	1	1	4	1	2	1	4
Socony Vacuum AMV AC781 (Grease)	1	1	4	1	2	1	4
Socony Vacuum PD959B	1	1	4	1	2	1	4
Soda Ash	1	1	1	1	1	X	1
Sodium Acetate	2	2	1	4	2	3	4
Sodium Acid Bisulfate	3	3	1	3	1	4	2
Sodium Acid Fluoride	3	3	1	3	1	4	2
Sodium Acid Sulfate	3	3	1	3	1	4	2
Sodium Aluminate	3	3	1	3	1	4	2
Sodium Aluminate Sulfate	3	3	1	3	1	4	2
Sodium Anthraquinone Disulfate	3	3	1	3	1	4	2
Sodium Antimonate	3	3	1	3	1	4	2
Sodium Arsenate	3	3	1	3	1	4	2
Sodium Arsenite	3	3	1	3	1	4	2
Sodium Benzoate	3	3	1	3	1	4	2
Sodium Bicarbonate (Baking Soda)	1	1	1	1	1	X	1
Sodium Bichromate	3	3	1	3	1	4	2
Sodium Bifluoride	3	3	1	3	1	4	2
Sodium Bisulfate or Bisulfite	1	1	1	1	1	4	1
Sodium Bisulfide	3	3	1	3	1	4	2
Sodium Bitartrate	3	3	1	3	1	4	2
Sodium Borate	1	1	1	1	1	X	1
Sodium Bromate	3	3	1	3	1	4	2
Sodium Bromide	3	3	1	3	1	4	2
Sodium Carbonate (Soda Ash)	1	1	1	1	1	X	1
Sodium Chlorate	3	3	1	3	1	4	2
Sodium Chloride	1	1	1	1	1	X	1
Sodium Chlorite	3	3	1	3	1	4	2
Sodium Chloroacetate	3	3	1	3	1	4	2
Sodium Chromate	3	3	1	3	1	4	2
Sodium Citrate	3	3	1	3	1	4	2
Sodium Cyanamide	3	3	1	3	1	4	2
Sodium Cyanate	3	3	1	3	1	4	2
Sodium Cyanide	1	1	1	X	1	X	1
Sodium Diacetate	3	3	1	3	1	4	2
Sodium Diphenyl Sulfonate	3	3	1	3	1	4	2
Sodium Diphosphate	3	3	1	3	1	4	2
Sodium Disilicate	3	3	1	3	1	4	2
Sodium Ethylate	3	3	1	3	1	4	2
Sodium Ferricyanide	3	3	1	3	1	4	2
Sodium Ferrocyanide	3	3	1	3	1	4	2
Sodium Fluoride	3	3	1	3	1	4	2
Sodium Fluorosilicate	3	3	1	3	1	4	2
Sodium Glutamate	3	3	1	3	1	4	2

03/03/06



Chemical Compatibility

COMPOUND COMPATIBILITY RATING 1 — Satisfactory 2 — Fair (usually OK for static seal) 3 — Doubtful (sometimes OK for static seal) 4 — Unsatisfactory X — Insufficient Data							
	Nitrile NBR	Hydrogenated Nitrile HNBR	Ethylene Propylene EPDM	Fluorocarbon FKM	Neoprene/Chloroprene CR	Polyacrylate ACM	Silicone MQ, VMQ, PVMQ
Sodium Hydrogen Sulfate	3	3	1	3	1	4	2
Sodium Hydrosulfide	3	3	1	3	1	4	2
Sodium Hydrosulfite	3	3	1	3	1	4	2
Sodium Hydroxide, 3 Molar	2	2	1	2	2	4	1
Sodium Hypochlorite	2	2	1	1	2	4	2
Sodium Hypophosphate	3	3	1	3	1	4	2
Sodium Hypophosphite	3	3	1	3	1	4	2
Sodium Hyposulfite	3	3	1	3	1	4	2
Sodium Iodide	3	3	1	3	1	4	2
Sodium Lactate	3	3	1	3	1	4	2
Sodium Metaphosphate	1	1	1	1	2	X	X
Sodium Metasilicate	3	3	1	3	1	4	2
Sodium Methylate	3	3	1	3	1	4	2
Sodium Monophosphate	3	3	1	3	1	4	2
Sodium Nitrate	2	2	1	X	2	X	4
Sodium Oleate	3	3	1	3	1	4	2
Sodium Orthosilicate	3	3	1	3	1	4	2
Sodium Oxalate	3	3	1	3	1	4	2
Sodium Perborate	2	2	1	1	2	X	2
Sodium Percarbonate	3	3	1	3	1	4	2
Sodium Perchlorate	3	3	1	3	1	4	2
Sodium Peroxide	2	2	1	1	2	4	4
Sodium Persulfate	3	3	1	3	1	4	2
Sodium Phenolate	3	3	1	3	1	4	2
Sodium Phenoxide	3	3	1	3	1	4	2
Sodium Phosphate (Dibasic)	1	1	1	1	2	1	4
Sodium Phosphate (Mono)	1	1	1	1	2	1	4
Sodium Phosphate (Tribasic)	1	1	1	1	2	1	1
Sodium Plumbite	3	3	1	3	1	4	2
Sodium Pyrophosphate	3	3	1	3	1	4	2
Sodium Resinate	3	3	1	3	1	4	2
Sodium Salicylate	3	3	1	3	1	4	2
Sodium Salts	1	1	1	1	2	1	1
Sodium Silicate	1	1	1	1	1	X	X
Sodium Stannate	3	3	1	3	1	4	2
Sodium Sulfate	1	1	1	1	1	4	1
Sodium Sulfide and Sulfite	1	1	1	1	1	4	1
Sodium Sulfocyanide	3	3	1	3	1	4	2
Sodium Tartrate	3	3	1	3	1	4	2
Sodium Tetraborate	3	3	1	3	1	4	2
Sodium Tetraphosphate	3	3	1	3	1	4	2
Sodium Tetrasulfide	3	3	1	3	1	4	2
Sodium Thioarsenate	3	3	1	3	1	4	2
Sodium Thiocyanate	3	3	1	3	1	4	2
Sodium Thiosulfate	2	2	1	1	1	4	1
Sodium Trichloroacetate	3	3	1	3	1	4	2
Sodium Triphosphate	3	3	1	3	1	4	2
Sorbitol	3	3	1	3	1	4	2
Sour Crude Oil	3	3	4	1	4	4	4
Sour Natural Gas	3	3	4	1	4	4	4
Sovasol No. 1, 2, and 3	1	1	4	1	2	2	4
Sovasol No. 73 and 74	2	2	4	1	2	2	4
Soybean Oil	1	1	3	1	3	1	1
Spry	1	1	2	1	2	1	1
SR-10 Fuel	1	1	4	1	4	2	4
SR-6 Fuel	2	2	4	1	4	2	4
Standard Oil Mobilube GX90-EP Lube	1	1	4	1	2	1	4
Stannic Ammonium Chloride	3	3	1	3	1	4	2

COMPOUND COMPATIBILITY RATING 1 — Satisfactory 2 — Fair (usually OK for static seal) 3 — Doubtful (sometimes OK for static seal) 4 — Unsatisfactory X — Insufficient Data							
	Nitrile NBR	Hydrogenated Nitrile HNBR	Ethylene Propylene EPDM	Fluorocarbon FKM	Neoprene/Chloroprene CR	Polyacrylate ACM	Silicone MQ, VMQ, PVMQ
Stannic Chloride	1	1	1	1	4	X	2
Stannic Chloride, 50%	1	1	1	1	4	X	2
Stannic Tetrachloride	3	3	1	3	1	4	2
Stannous Bisulfate	3	3	1	3	1	4	2
Stannous Bromide	3	3	1	3	1	4	2
Stannous Chloride (15%)	1	1	1	1	1	X	2
Stannous Fluoride	3	3	1	3	1	4	2
Stannous Sulfate	3	3	1	3	1	4	2
Stauffer 7700	2	2	4	1	4	2	4
Steam Below 400 °F	4	4	1	4	4	4	3
Steam, 400 – 500 °F	4	4	3	4	4	4	4
Stearic Acid	2	2	2	X	2	X	2
Stoddard Solvent	1	1	4	1	2	1	4
Strontium Acetate	3	3	1	3	1	4	2
Strontium Carbonate	3	3	1	3	1	4	2
Strontium Chloride	3	3	1	3	1	4	2
Strontium Hydroxide	3	3	1	3	1	4	2
Strontium Nitrate	3	3	1	3	1	4	2
Styrene (Monomer)	4	4	4	2	4	4	4
Succinic Acid	3	3	1	3	1	4	2
Sucrose Solutions	1	1	1	1	2	4	1
Sulfamic Acid	3	3	1	3	1	4	2
Sulfanilic Acid	3	3	1	3	1	4	2
Sulfanilic Chloride	2	2	4	1	4	4	X
Sulfanilimide	2	2	4	1	4	4	X
Sulfite Liquors	3	3	1	3	1	4	2
Sulfolane	2	2	1	2	2	X	X
Sulfonated Oils	2	2	4	1	4	4	X
Sulfonic Acid	3	3	1	3	1	4	2
Sulfonyl Chloride	3	3	1	3	1	4	2
Sulfur	4	4	1	1	1	4	X
Sulfur (Molten)	4	4	3	1	3	4	3
Sulfur Chloride	4	4	4	1	4	4	3
Sulfur Dioxide, Dry	4	4	1	4	4	4	2
Sulfur Dioxide, Liquidified under pressure	4	4	1	4	4	4	2
Sulfur Dioxide, Wet	4	4	1	4	2	4	2
Sulfur Hexafluoride	2	2	1	3	1	X	X
Sulfur Liquors	2	2	2	1	2	4	4
Sulfur Monochloride	1	1	4	1	2	1	2
Sulfur Trioxide Dry	4	4	2	1	4	4	2
Sulfuric Acid (20% Oleum)	3	3	1	3	1	4	2
Sulfuric Acid, 3 Molar to 158 °F	2	2	1	1	2	2	1
Sulfuric Acid, Concentrated Room Temp	X	X	3	1	X	X	X
Sulfuric Acid, Concentrated to 158 °F	4	X	4	1	4	4	4
Sulfuric Chlorohydrin (Chlorosulfonic Acid)	3	3	1	3	1	4	2
Sulfurous Acid	2	2	2	1	2	4	4
Sunoco #3661	1	1	4	1	2	1	4
Sunoco All purpose grease	1	1	4	1	2	1	4
Sunoco SAE 10	1	1	4	1	2	1	4
Sunsafe (Fire resist. hydr. fluid)	1	1	4	1	2	4	X
Super Shell Gas	1	1	4	1	2	2	4
Surfuryl Chloride	3	3	1	3	1	4	2
Swan Finch EP Lube	1	1	4	1	4	1	4
Swan Finch Hypoid-90	1	1	4	1	2	1	4
T							
Tallow	1	1	4	1	2	1	2
Tannic Acid (10%)	1	1	1	1	1	4	2
Tar, bituminous	2	2	4	1	3	4	2



03/03/06



Chemical Compatibility

COMPOUND COMPATIBILITY RATING 1 — Satisfactory 2 — Fair (usually OK for static seal) 3 — Doubtful (sometimes OK for static seal) 4 — Unsatisfactory X — Insufficient Data	COMPOUND COMPATIBILITY RATING						
	Nitrile NBR	Hydrogenated Nitrile HNBR	Ethylene Propylene EPDM	Fluorocarbon FKM	Neoprene/Chloroprene CR	Polyacrylate ACM	Silicone MQ, VMQ, PVMQ
Tartaric Acid	1	1	2	1	2	X	1
Terephthalic Acid	3	3	1	3	1	4	2
Terpineol	2	2	3	1	4	X	X
Terpinyl Acetate	2	2	4	1	4	4	X
Tertiary Butyl Catechol or p-tert-butylcatechol	4	4	2	1	2	4	X
Tertiary Butyl Mercaptan	4	4	4	1	X	X	X
Tetrabromoethane	4	4	4	1	4	4	4
Tetrabromomethane	2	2	4	1	4	4	X
Tetrabutyl Titanate	2	2	1	1	2	X	4
Tetrachloroethylene	4	4	4	1	4	4	4
Tetrachoroethane	4	4	4	1	4	4	X
Tetraethyl Lead	2	2	4	1	2	X	X
Tetraethyl Lead "Blend"	2	2	4	1	4	X	X
Tetrahydrofuran	4	4	2	4	4	4	4
Tetralin	4	4	4	1	4	X	4
Tetramethyl Ammonium Hydroxide	3	3	1	3	1	4	2
Tetramethyldihydropyridine	2	2	4	1	4	4	X
Tetramethyldihydropyridine	2	2	4	1	4	4	X
Tetraphosphoglucosate	3	3	1	3	1	4	2
Texaco 3450 Gear Oil	1	1	4	1	4	1	4
Texaco Capella A and AA	1	1	4	1	2	1	4
Texaco Meropa 220 (No Lead)	1	1	4	1	2	1	4
Texaco Regal B	1	1	4	1	4	1	4
Texaco Uni-Temp Grease	1	1	4	1	2	1	2
Texamatic "A" 1581 Fluid	1	1	4	1	2	1	4
Texamatic "A" 3401 Fluid	1	1	4	1	2	1	4
Texamatic "A" 3525 Fluid	1	1	4	1	2	1	4
Texamatic "A" 3528 Fluid	1	1	4	1	2	1	4
Texamatic "A" Transmission Oil	1	1	4	1	2	1	4
Texas 1500 Oil	1	1	4	1	2	1	2
Therminol 44	4	4	4	1	4	4	4
Therminol 55	2	2	4	1	4	2	4
Therminol VP-1, 60, 65	4	4	4	1	4	4	2
Thioamyl Alcohol	1	1	4	1	2	1	2
Thiodiacetic Acid	3	3	1	3	1	4	2
Thioethanol	3	3	1	3	1	4	2
Thioglycolic Acid	3	3	1	3	1	4	2
Thiokol TP-90B	4	4	1	1	2	X	X
Thiokol TP-95	4	4	1	1	2	X	X
Thionyl Chloride	2	2	4	1	4	4	X
Thiophene (Thiofuran)	2	2	4	1	4	4	X
Thiophosphoryl Chloride	3	3	1	3	1	4	2
Thiourea	3	3	1	3	1	4	2
Thorium Nitrate	3	3	1	3	1	4	2
Tidewater Multigear, 140 EP Lube	1	1	4	1	2	1	4
Tidewater Oil-Beedol	1	1	4	1	2	1	2
Tin Ammonium Chloride	3	3	1	3	1	4	2
Tin Chloride	1	1	4	1	2	1	2
Tin Tetrachloride	1	1	4	1	2	1	2
Titanic Acid	3	3	1	3	1	4	2
Titanium Dioxide	3	3	1	3	1	4	2
Titanium Sulfate	3	3	1	3	1	4	2
Titanium Tetrachloride	2	2	4	1	4	4	4
Toluene	4	4	4	1	4	4	4
Toluene Diisocyanate (TDI)	4	4	2	4	4	4	4
Toluene Sulfonyl Chloride	2	2	4	1	4	4	X
Toluenesulfonic Acid	3	3	1	3	1	4	2
Toluidine	2	2	4	1	4	4	X

COMPOUND COMPATIBILITY RATING 1 — Satisfactory 2 — Fair (usually OK for static seal) 3 — Doubtful (sometimes OK for static seal) 4 — Unsatisfactory X — Insufficient Data	COMPOUND COMPATIBILITY RATING						
	Nitrile NBR	Hydrogenated Nitrile HNBR	Ethylene Propylene EPDM	Fluorocarbon FKM	Neoprene/Chloroprene CR	Polyacrylate ACM	Silicone MQ, VMQ, PVMQ
Toluol	3	3	1	3	1	4	2
Toluquinone	2	2	4	1	4	4	X
Tolylaldehyde	3	3	1	3	1	4	2
Transformer Oil	1	1	4	1	2	2	2
Transmission Fluid Type A	1	1	4	1	2	1	2
Triacetin	2	2	1	4	2	4	X
Triaryl Phosphate	4	4	1	1	4	4	3
Tribromomethylbenzene	2	2	4	1	4	4	X
Tributoxyethyl Phosphate	4	4	1	1	4	4	X
Tributyl Citrate	3	3	1	3	1	4	2
Tributyl Mercaptan	4	4	4	1	4	4	4
Tributyl Phosphate	4	4	1	4	4	4	4
Trichloroacetic Acid	2	2	2	3	4	4	X
Trichloroacetyl Chloride	2	2	4	1	4	4	X
Trichlorobenzene	2	2	4	1	4	4	X
Trichloroethane	4	4	4	1	4	4	4
Trichloroethanolamine	3	3	1	3	1	4	2
Trichloroethylene	3	3	4	1	4	4	4
Trichloromethane	4	4	4	1	4	4	4
Trichloronitromethane (Chloropicrin)	3	3	1	3	1	4	2
Trichloropropane	4	4	4	1	4	4	4
Trichlorosilane	4	4	4	1	4	4	4
Tricresyl Phosphate	4	4	1	2	3	4	3
Triethanol Amine	3	3	2	4	2	4	X
Triethyl Phosphate	2	2	4	1	4	4	X
Triethylene Glycol	3	3	1	3	1	4	2
Triethylenetetramine	3	3	1	3	1	4	2
Trifluoroacetic Acid	3	3	1	3	1	4	2
Trifluoroethane	4	4	4	1	4	4	4
Trifluoromethane	4	4	4	1	4	4	4
Trifluorovinylchloride	2	2	4	1	4	4	X
Triisopropylbenzylchloride	2	2	4	1	4	4	X
Trimethylamine	3	3	1	3	1	4	2
Trimethylamine (TMA)	3	3	1	3	1	4	2
Trimethylbenzene	2	2	4	1	4	4	X
Trimethylborate (TMB)	2	2	4	1	4	4	X
Trimethylpentane	1	1	4	1	2	1	2
Trinitrolozene (TNT)	4	4	4	2	2	4	X
Trioctyl Phosphate	4	4	1	2	4	4	3
Triphenylphosphite	3	3	1	3	1	4	2
Tripoly Phosphate	4	4	1	2	3	4	3
Tripotassium Phosphate	3	3	1	3	1	4	2
Trisodium Phosphate	3	3	1	3	1	4	2
Tung Oil (China Wood Oil)	1	1	4	1	2	X	4
Turbine Oil	1	1	4	1	4	1	4
Turbine Oil #15 (MIL-L-7808A)	2	2	4	1	4	2	4
Turbo Oil #35	1	1	4	1	2	1	4
Turpentine	1	1	4	1	4	2	4
Type I Fuel (MIL-S-3136) (ASTM Ref. Fuel A)	1	1	4	1	2	1	4
Type II Fuel MIL-S-3136	2	2	4	1	4	3	4
Type III Fuel MIL-S-3136 (ASTM Ref. Fuel B)	2	2	4	1	4	3	4
U							
Ucon Hydrolube J-4	1	1	1	1	2	4	1
Ucon Lubricant 50-HB-100	1	1	1	1	1	X	1
Ucon Lubricant 50-HB-260	1	1	1	1	1	X	1
Ucon Lubricant 50-HB-5100	1	1	1	1	1	X	1
Ucon Lubricant 50-HB55	1	1	1	1	1	X	1
Ucon Lubricant 50-HB-660	1	1	1	1	1	X	1

03/03/06



Chemical Compatibility

COMPOUND COMPATIBILITY RATING 1 — Satisfactory 2 — Fair (usually OK for static seal) 3 — Doubtful (sometimes OK for static seal) 4 — Unsatisfactory X — Insufficient Data							
	Nitrile NBR	Hydrogenated Nitrile HNBR	Ethylene Propylene EPDM	Fluorocarbon FKM	Neoprene/Chloroprene CR	Polyacrylate ACM	Silicone MQ, VMQ, PVMQ
Ucon Lubricant LB-1145	1	1	1	1	1	X	1
Ucon Lubricant LB-135	1	1	1	1	1	X	1
Ucon Lubricant LB-285	1	1	1	1	1	X	1
Ucon Lubricant LB-300X	1	1	1	1	1	X	1
Ucon Lubricant LB-625	1	1	1	1	1	X	1
Ucon Lubricant LB-65	1	1	1	1	1	X	1
Ucon Oil 50-HB-280X	2	2	1	3	2	X	X
Ucon Oil Heat Transfer Fluid 500 (Polyalkalene Glycol)	1	1	1	1	1	X	1
Ucon Oil LB-385	1	1	1	1	1	X	1
Ucon Oil LB-400X	1	1	1	1	1	X	1
Undecylenic Acid	2	2	4	1	4	4	X
Undecylic Acid	2	2	4	1	4	4	X
Univis 40 (Hydr. Fluid)	1	1	4	1	2	1	4
Univolt #35 (Mineral Oil)	1	1	4	1	2	1	4
Unsymmetrical Dimethyl Hydrazine (UDMH)	2	2	1	4	2	X	4
UPDI (Ultrapore Deionized Water)	3	3	1	3	1	4	2
Uranium Hexachloride	X	X	X	1	X	X	X
Uric Acid	3	3	1	3	1	4	2
V							
Valeraldehyde	3	3	1	3	1	4	2
Valeric Acid	3	3	1	3	1	4	2
Vanadium Oxide	1	1	4	1	2	1	2
Vanadium Pentoxide	1	1	4	1	2	1	2
Varnish	2	2	4	1	4	4	4
Vegetable Oil	1	1	3	1	3	1	1
Versilube F44, F55	1	1	1	1	1	X	X
Versilube F-50	1	1	1	1	1	1	3
Vinegar	2	2	2	3	2	4	3
Vinyl Acetate	2	2	1	3	2	X	X
Vinyl Benzene	2	2	4	1	4	4	X
Vinyl Benzoate	2	2	4	1	4	4	X
Vinyl Chloride	2	2	4	1	4	4	X
Vinyl Fluoride	2	2	4	1	4	4	X
Vinylidene Chloride	2	2	4	1	4	4	X
Vinylpyridine	2	2	4	1	4	4	X
Vitriol (White)	3	3	1	3	1	4	2
VV-H-910	3	3	1	1	2	2	2
W							
Wagner 21B Brake Fluid	3	3	1	4	2	X	3
Water	1	2	1	2	2	4	1

COMPOUND COMPATIBILITY RATING 1 — Satisfactory 2 — Fair (usually OK for static seal) 3 — Doubtful (sometimes OK for static seal) 4 — Unsatisfactory X — Insufficient Data							
	Nitrile NBR	Hydrogenated Nitrile HNBR	Ethylene Propylene EPDM	Fluorocarbon FKM	Neoprene/Chloroprene CR	Polyacrylate ACM	Silicone MQ, VMQ, PVMQ
Wemco C	1	1	4	1	2	1	4
Whiskey and Wines	1	1	1	1	1	4	1
White Liquor	1	1	1	1	1	X	X
White Oil	1	1	4	1	2	1	4
White Pine Oil	2	2	4	1	4	X	4
Wolmar Salt	1	1	1	1	2	2	1
Wood Alcohol	1	1	1	4	1	4	1
Wood Oil	1	1	4	1	2	1	4
X							
Xenon	1	1	1	1	1	1	1
Xylene	4	1	4	1	4	4	4
Xylenes-Mixed-Aromatic Amines	3	3	1	4	4	4	4
Xylol	4	4	4	1	4	4	4
Z							
Zeolites	1	1	1	1	1	X	X
Zinc Acetate	2	2	1	4	2	4	4
Zinc Ammonium Chloride	3	3	1	3	1	4	2
Zinc Chloride	1	1	1	1	1	4	X
Zinc Chromate	3	3	1	3	1	4	2
Zinc Cyanide	3	3	1	3	1	4	2
Zinc Diethyldithiocarbamate	3	3	1	3	1	4	2
Zinc Dihydrogen Phosphate	3	3	1	3	1	4	2
Zinc Hydrosulfite	3	3	1	3	1	4	2
Zinc Nitrate	1	1	1	1	X	4	X
Zinc Oxide	1	1	1	1	X	4	X
Zinc Phenolsulfonate	3	3	1	3	1	4	2
Zinc Phosphate	1	1	1	1	1	4	1
Zinc Salts	1	1	1	1	1	4	1
Zinc Stearate	3	3	1	3	1	4	2
Zinc Sulfate	1	1	1	1	1	4	1
Zinc Sulfide	3	3	1	3	1	4	2
Zirconium Nitrate	1	1	1	1	1	4	1



Old to New Part Number Interchange

Catalog EPS 5350/USA

Old Part No.	Shaft Dia.	Bore Dia.	Seal Width	Seal Type	MTRL	New Part No.
NTC80001	5	15	6	TC	NBR	5-15-6MTCN
NTC80003	5	16	7	TC	NBR	5-16-7MTCN
NTC80005	5	17	7	TC	NBR	5-17-7MTCN
NTC80007	6	16	5	TC	NBR	6-16-5MTCN
NTC80009	6	18	7	TC	NBR	6-18-7MTCN
NTC80011	7	16	7	TC	NBR	7-16-7MTCN
NTC80013	7	19	7	TC	NBR	7-19-7MTCN
NTC80015	7	22	6	TC	NBR	7-22-6MTCN
NTC80017	8	15	5	TC	NBR	8-15-5MTCN
NTC80019	8	16	7	TC	NBR	8-16-7MTCN
NTC80021	8	18	5	TC	NBR	8-18-5MTCN
NTC80023	8	20	5	TC	NBR	8-20-5MTCN
NTC80025	8	22	7	TC	NBR	8-22-7MTCN
NTC80027	8	30	6	TC	NBR	8-30-6MTCN
NTC80029	9	19	5	TC	NBR	9-19-5MTCN
NTC80031	9	20	7	TC	NBR	9-20-7MTCN
NTC80033	9	22	7	TC	NBR	9-22-7MTCN
NTC80035	9	24	7	TC	NBR	9-24-7MTCN
NTC80037	10	17	5	TC	NBR	10-17-5MTCN
NTC80039	10	18	7	TC	NBR	10-18-7MTCN
NTC80041	10	19	7	TC	NBR	10-19-7MTCN
NTC80043	10	22	7	TC	NBR	10-22-7MTCN
NTC80045	10	23	7	TC	NBR	10-23-7MTCN
NTC80047	10	24	6	TC	NBR	10-24-6MTCN
NTC80049	10	25	5	TC	NBR	10-25-5MTCN
NTC80051	10	26	7	TC	NBR	10-26-7MTCN
NTC80053	12	19	5	TC	NBR	12-19-5MTCN
NTC80055	12	20	4	TC	NBR	12-20-4MTCN
NTC80057	12	21	4	TC	NBR	12-21-4MTCN
NTC80059	12	22	7	TC	NBR	12-22-7MTCN
NTC80061	12	24	7	TC	NBR	12-24-7MTCN
NTC80063	12	25	7	TC	NBR	12-25-7MTCN
NTC80065	12	26	7	TC	NBR	12-26-7MTCN
NTC80067	12	28	7	TC	NBR	12-28-7MTCN
NTC80069	12	30	7	TC	NBR	12-30-7MTCN
NTC80071	13	22	4	TC	NBR	13-22-4MTCN
NTC80073	13	26	7	TC	NBR	13-26-7MTCN
NTC80075	14	20	4	TC	NBR	14-20-4MTCN
NTC80077	14	22	5	TC	NBR	14-22-5MTCN
NTC80079	14	24	7	TC	NBR	14-24-7MTCN
NTC80081	14	25	5	TC	NBR	14-25-5MTCN
NTC80083	14	25	7	TC	NBR	14-25-7MTCN
NTC80085	14	26	7	TC	NBR	14-26-7MTCN
NTC80087	14	28	7	TC	NBR	14-28-7MTCN
NTC80089	14	30	7	TC	NBR	14-30-7MTCN
NTC80091	14	32	7	TC	NBR	14-32-7MTCN
NTC80093	14	35	7	TC	NBR	14-35-7MTCN
NTC80095	15	22	5	TC	NBR	15-22-5MTCN
NTC80097	15	23	7	TC	NBR	15-23-7MTCN
NTC80099	15	24	5	TC	NBR	15-24-5MTCN
NTC80101	15	25	5	TC	NBR	15-25-5MTCN
NTC80103	15	25	7	TC	NBR	15-25-7MTCN

Old Part No.	Shaft Dia.	Bore Dia.	Seal Width	Seal Type	MTRL	New Part No.
NTC80105	15	26	7	TC	NBR	15-26-7MTCN
NTC80107	15	27	7	TC	NBR	15-27-7MTCN
NTC80109	15	28	7	TC	NBR	15-28-7MTCN
NTC80111	15	30	7	TC	NBR	15-30-7MTCN
NTC80113	15	32	7	TC	NBR	15-32-7MTCN
NTC80115	15	35	7	TC	NBR	15-35-7MTCN
NTC80117	15	40	10	TC	NBR	15-40-10MTCN
NTC80119	15	42	10	TC	NBR	15-42-10MTCN
NTC80121	16	24	5	TC	NBR	16-24-5MTCN
NTC80123	16	25	6	TC	NBR	16-25-6MTCN
NTC80125	16	26	6	TC	NBR	16-26-6MTCN
NTC80127	16	27	6	TC	NBR	16-27-6MTCN
NTC80129	16	28	7	TC	NBR	16-28-7MTCN
NTC80131	16	29	7	TC	NBR	16-29-7MTCN
NTC80133	16	30	7	TC	NBR	16-30-7MTCN
NTC80135	16	32	7	TC	NBR	16-32-7MTCN
NTC80137	16	35	7	TC	NBR	16-35-7MTCN
NTC80139	16	40	1	TC	NBR	16-40-1MTCN
NTC80141	17	25	4	TC	NBR	17-25-4MTCN
NTC80143	17	27	7	TC	NBR	17-27-7MTCN
NTC80145	17	28	6	TC	NBR	17-28-6MTCN
NTC80147	17	29	5	TC	NBR	17-29-5MTCN
NTC80149	17	30	7	TC	NBR	17-30-7MTCN
NTC80151	17	32	7	TC	NBR	17-32-7MTCN
NTC80153	17	33	7	TC	NBR	17-33-7MTCN
NTC80155	17	34	4	TC	NBR	17-34-4MTCN
NTC80157	17	35	7	TC	NBR	17-35-7MTCN
NTC80159	17	37	7	TC	NBR	17-37-7MTCN
NTC80161	17	40	5	TC	NBR	17-40-5MTCN
NTC80163	17	47	7	TC	NBR	17-47-7MTCN
NTC80165	18	28	6	TC	NBR	18-28-6MTCN
NTC80167	18	30	5	TC	NBR	18-30-5MTCN
NTC80169	18	32	7	TC	NBR	18-32-7MTCN
NTC80171	18	35	7	TC	NBR	18-35-7MTCN
NTC80173	18	38	7	TC	NBR	18-38-7MTCN
NTC80175	18	40	7	TC	NBR	18-40-7MTCN
NTC80177	18	47	10	TC	NBR	18-47-10MTCN
NTC80179	19	24	7	TC	NBR	19-24-7MTCN
NTC80181	19	27	4	TC	NBR	19-27-4MTCN
NTC80183	19	30	5	TC	NBR	19-30-5MTCN
NTC80185	19	32	7	TC	NBR	19-32-7MTCN
NTC80187	19	35	7	TC	NBR	19-35-7MTCN
NTC80189	19	37	10	TC	NBR	19-37-10MTCN
NTC80191	19	47	7	TC	NBR	19-47-7MTCN
NTC80193	20	28	6	TC	NBR	20-28-6MTCN
NTC80195	20	30	5	TC	NBR	20-30-5MTCN
NTC80197	20	32	6	TC	NBR	20-32-6MTCN
NTC80199	20	35	7	TC	NBR	20-35-7MTCN
NTC80201	20	36	7	TC	NBR	20-36-7MTCN
NTC80203	20	37	7	TC	NBR	20-37-7MTCN
NTC80205	20	38	5	TC	NBR	20-38-5MTCN
NTC80207	20	40	7	TC	NBR	20-40-7MTCN

03/03/06



Old to New Part Number Interchange

Old Part No.	Shaft Dia.	Bore Dia.	Seal Width	Seal Type	MTRL	New Part No.
NTC80209	20	42	7	TC	NBR	20-42-7MTCN
NTC80211	20	45	7	TC	NBR	20-45-7MTCN
NTC80213	20	47	7	TC	NBR	20-47-7MTCN
NTC80215	20	52	7	TC	NBR	20-52-7MTCN
NTC80217	22	30	7	TC	NBR	22-30-7MTCN
NTC80219	22	32	7	TC	NBR	22-32-7MTCN
NTC80221	22	35	7	TC	NBR	22-35-7MTCN
NTC80223	22	36	7	TC	NBR	22-36-7MTCN
NTC80225	22	38	7	TC	NBR	22-38-7MTCN
NTC80227	22	40	7	TC	NBR	22-40-7MTCN
NTC80229	22	42	7	TC	NBR	22-42-7MTCN
NTC80231	22	47	7	TC	NBR	22-47-7MTCN
NTC80233	23	34	8	TC	NBR	23-34-8MTCN
NTC80235	23	36	7	TC	NBR	23-36-7MTCN
NTC80237	23	40	7	TC	NBR	23-40-7MTCN
NTC80239	23	47	7	TC	NBR	23-47-7MTCN
NTC80241	24	34	7	TC	NBR	24-34-7MTCN
NTC80243	24	35	6	TC	NBR	24-35-6MTCN
NTC80245	24	36	7	TC	NBR	24-36-7MTCN
NTC80247	24	37	7	TC	NBR	24-37-7MTCN
NTC80249	24	38	8	TC	NBR	24-38-8MTCN
NTC80251	24	40	7	TC	NBR	24-40-7MTCN
NTC80253	24	42	8	TC	NBR	24-42-8MTCN
NTC80255	24	45	7	TC	NBR	24-45-7MTCN
NTC80257	24	52	7	TC	NBR	24-52-7MTCN
NTC80259	25	35	5	TC	NBR	25-35-5MTCN
NTC80261	25	36	7	TC	NBR	25-36-7MTCN
NTC80263	25	37	6	TC	NBR	25-37-6MTCN
NTC80265	25	38	5	TC	NBR	25-38-5MTCN
NTC80267	25	40	7	TC	NBR	25-40-7MTCN
NTC80269	25	42	6	TC	NBR	25-42-6MTCN
NTC80271	25	43	10	TC	NBR	25-43-10MTCN
NTC80273	25	44	7	TC	NBR	25-44-7MTCN
NTC80275	25	45	7	TC	NBR	25-45-7MTCN
NTC80277	25	46	7	TC	NBR	25-46-7MTCN
NTC80279	25	47	7	TC	NBR	25-47-7MTCN
NTC80281	25	47	7	TC	NBR	25-47-7MTCN
NTC80283	25	48	7	TC	NBR	25-48-7MTCN
NTC80285	25	50	10	TC	NBR	25-50-10MTCN
NTC80287	25	52	7	TC	NBR	25-52-7MTCN
NTC80289	26	36	7	TC	NBR	26-36-7MTCN
NTC80291	26	37	7	TC	NBR	26-37-7MTCN
NTC80293	26	38	5	TC	NBR	26-38-5MTCN
NTC80295	26	40	7	TC	NBR	26-40-7MTCN
NTC80297	26	42	7	TC	NBR	26-42-7MTCN
NTC80299	26	47	7	TC	NBR	26-47-7MTCN
NTC80301	26	48	7	TC	NBR	26-48-7MTCN
NTC80303	26	50	10	TC	NBR	26-50-10MTCN
NTC80305	26	62	9	TC	NBR	26-62-9MTCN
NTC80307	26	72	10	TC	NBR	26-72-10MTCN
NTC80309	27	37	7	TC	NBR	27-37-7MTCN
NTC80311	27	40	8	TC	NBR	27-40-8MTCN
NTC80313	27	42	7	TC	NBR	27-42-7MTCN
NTC80315	27	43	8	TC	NBR	27-43-8MTCN
NTC80317	27	45	9	TC	NBR	27-45-9MTCN
NTC80319	28	35	5	TC	NBR	28-35-5MTCN
NTC80321	28	37	5	TC	NBR	28-37-5MTCN
NTC80323	28	38	7	TC	NBR	28-38-7MTCN

Old Part No.	Shaft Dia.	Bore Dia.	Seal Width	Seal Type	MTRL	New Part No.
NTC80325	28	40	7	TC	NBR	28-40-7MTCN
NTC80327	28	41	7	TC	NBR	28-41-7MTCN
NTC80329	28	42	7	TC	NBR	28-42-7MTCN
NTC80331	28	43	7	TC	NBR	28-43-7MTCN
NTC80333	28	45	7	TC	NBR	28-45-7MTCN
NTC80335	28	48	7	TC	NBR	28-48-7MTCN
NTC80337	28	50	8	TC	NBR	28-50-8MTCN
NTC80339	28	52	7	TC	NBR	28-52-7MTCN
NTC80341	28	60	10	TC	NBR	28-60-10MTCN
NTC80343	28	62	10	TC	NBR	28-62-10MTCN
NTC80347	29	46	10	TC	NBR	29-46-10MTCN
NTC80349	29	50	10	TC	NBR	29-50-10MTCN
NTC80351	30	40	7	TC	NBR	30-40-7MTCN
NTC80353	30	41	7	TC	NBR	30-41-7MTCN
NTC80355	30	42	7	TC	NBR	30-42-7MTCN
NTC80357	30	44	7	TC	NBR	30-44-7MTCN
NTC80359	30	45	7	TC	NBR	30-45-7MTCN
NTC80361	30	46	7	TC	NBR	30-46-7MTCN
NTC80363	30	47	7	TC	NBR	30-47-7MTCN
NTC80365	30	48	7	TC	NBR	30-48-7MTCN
NTC80367	30	50	8	TC	NBR	30-50-8MTCN
NTC80369	30	52	7	TC	NBR	30-52-7MTCN
NTC80371	30	55	7	TC	NBR	30-55-7MTCN
NTC80373	30	56	10	TC	NBR	30-56-10MTCN
NTC80375	30	58	10	TC	NBR	30-58-10MTCN
NTC80377	30	60	10	TC	NBR	30-60-10MTCN
NTC80379	30	62	7	TC	NBR	30-62-7MTCN
NTC80381	30	65	10	TC	NBR	30-65-10MTCN
NTC80383	30	72	8	TC	NBR	30-72-8MTCN
NTC80385	30	75	10	TC	NBR	30-75-10MTCN
NTC80387	31	49	7	TC	NBR	31-49-7MTCN
NTC80389	31	52	6	TC	NBR	31-52-6MTCN
NTC80391	32	40	7	TC	NBR	32-40-7MTCN
NTC80393	32	42	7	TC	NBR	32-42-7MTCN
NTC80395	32	43	7	TC	NBR	32-43-7MTCN
NTC80397	32	44	7	TC	NBR	32-44-7MTCN
NTC80399	32	45	6	TC	NBR	32-45-6MTCN
NTC80401	32	46	7	TC	NBR	32-46-7MTCN
NTC80403	32	47	7	TC	NBR	32-47-7MTCN
NTC80405	32	48	7	TC	NBR	32-48-7MTCN
NTC80407	32	50	7	TC	NBR	32-50-7MTCN
NTC80409	32	52	7	TC	NBR	32-52-7MTCN
NTC80411	32	53	7	TC	NBR	32-53-7MTCN
NTC80413	32	54	10	TC	NBR	32-54-10MTCN
NTC80415	32	55	7	TC	NBR	32-55-7MTCN
NTC80417	32	56	10	TC	NBR	32-56-10MTCN
NTC80419	32	58	10	TC	NBR	32-58-10MTCN
NTC80421	32	62	7	TC	NBR	32-62-7MTCN
NTC80423	32	65	10	TC	NBR	32-65-10MTCN
NTC80425	33	50	6	TC	NBR	33-50-6MTCN
NTC80427	32	52	6	TC	NBR	32-52-6MTCN
NTC80429	33	55	10	TC	NBR	33-55-10MTCN
NTC80431	33	66	12	TC	NBR	33-66-12MTCN
NTC80433	34	44	8	TC	NBR	34-44-8MTCN
NTC80435	34	46	8	TC	NBR	34-46-8MTCN
NTC80437	34	47	10	TC	NBR	34-47-10MTCN
NTC80439	34	48	7	TC	NBR	34-48-7MTCN
NTC80441	34	50	7	TC	NBR	34-50-7MTCN

03/03/06



Old to New Part Number Interchange

Old Part No.	Shaft Dia.	Bore Dia.	Seal Width	Seal Type	MTRL	New Part No.
NTC80443	34	52	10	TC	NBR	34-52-10MTCN
NTC80445	34	62	10	TC	NBR	34-62-10MTCN
NTC80447	35	42	8	TC	NBR	35-42-8MTCN
NTC80449	35	45	7	TC	NBR	35-45-7MTCN
NTC80451	35	47	7	TC	NBR	35-47-7MTCN
NTC80453	35	48	7	TC	NBR	35-48-7MTCN
NTC80455	35	50	7	TC	NBR	35-50-7MTCN
NTC80457	35	52	6	TC	NBR	35-52-6MTCN
NTC80459	35	52	7	TC	NBR	35-52-7MTCN
NTC80461	35	54	8	TC	NBR	35-54-8MTCN
NTC80463	35	54	8	TC	NBR	35-54-8MTCN
NTC80465	35	55	8	TC	NBR	35-55-8MTCN
NTC80467	35	55	8	TC	NBR	35-55-8MTCN
NTC80469	35	56	10	TC	NBR	35-56-10MTCN
NTC80471	35	58	10	TC	NBR	35-58-10MTCN
NTC80473	35	60	10	TC	NBR	35-60-10MTCN
NTC80475	35	62	6	TC	NBR	35-62-6MTCN
NTC80477	35	62	7	TC	NBR	35-62-7MTCN
NTC80479	35	70	10	TC	NBR	35-70-10MTCN
NTC80481	35	72	7	TC	NBR	35-72-7MTCN
NTC80483	35	80	8	TC	NBR	35-80-8MTCN
NTC80485	36	47	7	TC	NBR	36-47-7MTCN
NTC80487	36	49	7	TC	NBR	36-49-7MTCN
NTC80489	36	50	7	TC	NBR	36-50-7MTCN
NTC80491	36	52	7	TC	NBR	36-52-7MTCN
NTC80493	36	54	7	TC	NBR	36-54-7MTCN
NTC80495	36	58	8	TC	NBR	36-58-8MTCN
NTC80497	36	62	7	TC	NBR	36-62-7MTCN
NTC80499	36	68	10	TC	NBR	36-68-10MTCN
NTC80501	37	53	7	TC	NBR	37-53-7MTCN
NTC80503	37	64	13	TC	NBR	37-64-13MTCN
NTC80505	38	50	7	TC	NBR	38-50-7MTCN
NTC80507	38	52	7	TC	NBR	38-52-7MTCN
NTC80509	38	54	10	TC	NBR	38-54-10MTCN
NTC80511	38	55	7	TC	NBR	38-55-7MTCN
NTC80513	38	56	10	TC	NBR	38-56-10MTCN
NTC80515	38	58	8	TC	NBR	38-58-8MTCN
NTC80517	38	60	10	TC	NBR	38-60-10MTCN
NTC80519	38	62	7	TC	NBR	38-62-7MTCN
NTC80521	38	65	10	TC	NBR	38-65-10MTCN
NTC80523	38	72	8	TC	NBR	38-72-8MTCN
NTC80525	38	74	11	TC	NBR	38-74-11MTCN
NTC80527	40	52	7	TC	NBR	40-52-7MTCN
NTC80529	40	54	7	TC	NBR	40-54-7MTCN
NTC80531	40	55	7	TC	NBR	40-55-7MTCN
NTC80533	40	56	8	TC	NBR	40-56-8MTCN
NTC80535	40	58	8	TC	NBR	40-58-8MTCN
NTC80537	40	60	7	TC	NBR	40-60-7MTCN
NTC80539	40	62	5	TC	NBR	40-62-5MTCN
NTC80541	40	64	10	TC	NBR	40-64-10MTCN
NTC80543	40	65	7	TC	NBR	40-65-7MTCN
NTC80545	40	68	6	TC	NBR	40-68-6MTCN
NTC80547	40	70	12	TC	NBR	40-70-12MTCN
NTC80549	40	72	7	TC	NBR	40-72-7MTCN
NTC80551	40	75	8	TC	NBR	40-75-8MTCN
NTC80553	40	76	8	TC	NBR	40-76-8MTCN
NTC80555	40	80	7	TC	NBR	40-80-7MTCN
NTC80557	40	85	10	TC	NBR	40-85-10MTCN

Old Part No.	Shaft Dia.	Bore Dia.	Seal Width	Seal Type	MTRL	New Part No.
NTC80559	42	52	7	TC	NBR	42-52-7MTCN
NTC80561	42	55	7	TC	NBR	42-55-7MTCN
NTC80563	42	56	7	TC	NBR	42-56-7MTCN
NTC80565	42	58	8	TC	NBR	42-58-8MTCN
NTC80567	42	60	7	TC	NBR	42-60-7MTCN
NTC80569	42	62	7	TC	NBR	42-62-7MTCN
NTC80571	42	64	8	TC	NBR	42-64-8MTCN
NTC80573	42	65	9	TC	NBR	42-65-9MTCN
NTC80575	42	70	10	TC	NBR	42-70-10MTCN
NTC80577	42	72	8	TC	NBR	42-72-8MTCN
NTC80579	42	75	10	TC	NBR	42-75-10MTCN
NTC80581	42	76	12	TC	NBR	42-76-12MTCN
NTC80583	42	78	10	TC	NBR	42-78-10MTCN
NTC80585	43	54	7	TC	NBR	43-54-7MTCN
NTC80587	43	62	8	TC	NBR	43-62-8MTCN
NTC80589	44	60	4	TC	NBR	44-60-4MTCN
NTC80591	44	62	8	TC	NBR	44-62-8MTCN
NTC80593	44	70	12	TC	NBR	44-70-12MTCN
NTC80595	45	55	6	TC	NBR	45-55-6MTCN
NTC80597	45	57	9	TC	NBR	45-57-9MTCN
NTC80599	45	59	7	TC	NBR	45-59-7MTCN
NTC80601	45	60	7	TC	NBR	45-60-7MTCN
NTC80603	45	62	7	TC	NBR	45-62-7MTCN
NTC80605	45	65	8	TC	NBR	45-65-8MTCN
NTC80607	45	68	10	TC	NBR	45-68-10MTCN
NTC80609	45	70	10	TC	NBR	45-70-10MTCN
NTC80611	45	72	8	TC	NBR	45-72-8MTCN
NTC80613	45	75	10	TC	NBR	45-75-10MTCN
NTC80615	45	80	10	TC	NBR	45-80-10MTCN
NTC80617	45	85	10	TC	NBR	45-85-10MTCN
NTC80619	45	90	10	TC	NBR	45-90-10MTCN
NTC80621	48	60	9	TC	NBR	48-60-9MTCN
NTC80623	48	62	7	TC	NBR	48-62-7MTCN
NTC80625	48	65	9	TC	NBR	48-65-9MTCN
NTC80627	48	68	10	TC	NBR	48-68-10MTCN
NTC80629	48	70	9	TC	NBR	48-70-9MTCN
NTC80631	48	72	8	TC	NBR	48-72-8MTCN
NTC80633	48	74	10	TC	NBR	48-74-10MTCN
NTC80635	48	75	10	TC	NBR	48-75-10MTCN
NTC80637	48	80	10	TC	NBR	48-80-10MTCN
NTC80639	48	82	11	TC	NBR	48-82-11MTCN
NTC80641	48	90	13	TC	NBR	48-90-13MTCN
NTC80643	50	32	5	TC	NBR	50-32-5MTCN
NTC80645	50	58	4	TC	NBR	50-58-4MTCN
NTC80647	50	60	8	TC	NBR	50-60-8MTCN
NTC80649	50	62	7	TC	NBR	50-62-7MTCN
NTC80651	50	63	8	TC	NBR	50-63-8MTCN
NTC80653	50	65	8	TC	NBR	50-65-8MTCN
NTC80655	50	65	10	TC	NBR	50-65-10MTCN
NTC80657	50	68	8	TC	NBR	50-68-8MTCN
NTC80659	50	70	8	TC	NBR	50-70-8MTCN
NTC80661	50	72	8	TC	NBR	50-72-8MTCN
NTC80663	50	75	8	TC	NBR	50-75-8MTCN
NTC80665	50	80	8	TC	NBR	50-80-8MTCN
NTC80667	50	90	10	TC	NBR	50-90-10MTCN
NTC80669	52	62	10	TC	NBR	52-62-10MTCN
NTC80671	52	63	10	TC	NBR	52-63-10MTCN
NTC80673	52	65	9	TC	NBR	52-65-9MTCN

03/03/06



Old to New Part Number Interchange

Old Part No.	Shaft Dia.	Bore Dia.	Seal Width	Seal Type	MTRL	New Part No.
NTC80675	52	68	8	TC	NBR	52-68-8MTCN
NTC80677	52	70	8	TC	NBR	52-70-8MTCN
NTC80679	52	72	8	TC	NBR	52-72-8MTCN
NTC80681	52	78	10	TC	NBR	52-78-10MTCN
NTC80685	54	68	10	TC	NBR	54-68-10MTCN
NTC80687	54	72	10	TC	NBR	54-72-10MTCN
NTC80689	54	80	10	TC	NBR	54-80-10MTCN
NTC80691	54	81	10	TC	NBR	54-81-10MTCN
NTC80693	54	82	10	TC	NBR	54-82-10MTCN
NTC80695	54	85	10	TC	NBR	54-85-10MTCN
NTC80697	55	62	7	TC	NBR	55-62-7MTCN
NTC80699	55	65	8	TC	NBR	55-65-8MTCN
NTC80701	55	68	8	TC	NBR	55-68-8MTCN
NTC80703	55	70	8	TC	NBR	55-70-8MTCN
NTC80705	55	72	8	TC	NBR	55-72-8MTCN
NTC80707	55	75	8	TC	NBR	55-75-8MTCN
NTC80709	55	78	10	TC	NBR	55-78-10MTCN
NTC80711	55	80	8	TC	NBR	55-80-8MTCN
NTC80713	55	85	8	TC	NBR	55-85-8MTCN
NTC80715	55	90	10	TC	NBR	55-90-10MTCN
NTC80717	55	100	10	TC	NBR	55-100-10MTCN
NTC80719	56	67	7	TC	NBR	56-67-7MTCN
NTC80721	56	72	8	TC	NBR	56-72-8MTCN
NTC80723	56	75	8	TC	NBR	56-75-8MTCN
NTC80725	56	80	8	TC	NBR	56-80-8MTCN
NTC80727	56	85	8	TC	NBR	56-85-8MTCN
NTC80729	56	100	10	TC	NBR	56-100-10MTCN
NTC80731	57	72	9	TC	NBR	57-72-9MTCN
NTC80733	57	80	12	TC	NBR	57-80-12MTCN
NTC80735	57	805	10	TC	NBR	57-805-10MTCN
NTC80737	58	72	8	TC	NBR	58-72-8MTCN
NTC80739	58	80	8	TC	NBR	58-80-8MTCN
NTC80741	60	74	10	TC	NBR	60-74-10MTCN
NTC80743	60	75	8	TC	NBR	60-75-8MTCN
NTC80745	60	75	12	TC	NBR	60-75-12MTCN
NTC80747	60	78	9	TC	NBR	60-78-9MTCN
NTC80749	60	80	7	TC	NBR	60-80-7MTCN
NTC80751	60	82	9	TC	NBR	60-82-9MTCN
NTC80753	60	84	10	TC	NBR	60-84-10MTCN
NTC80755	60	85	8	TC	NBR	60-85-8MTCN
NTC80757	60	86	10	TC	NBR	60-86-10MTCN
NTC80759	60	90	8	TC	NBR	60-90-8MTCN
NTC80761	60	95	10	TC	NBR	60-95-10MTCN
NTC80763	60	100	10	TC	NBR	60-100-10MTCN
NTC80765	62	80	10	TC	NBR	62-80-10MTCN
NTC80767	62	80	12	TC	NBR	62-80-12MTCN
NTC80769	62	85	10	TC	NBR	62-85-10MTCN
NTC80771	62	90	10	TC	NBR	62-90-10MTCN
NTC80773	62	110	13	TC	NBR	62-110-13MTCN
NTC80775	63	80	9	TC	NBR	63-80-9MTCN
NTC80777	63	88	12	TC	NBR	63-88-12MTCN
NTC80779	63	90	10	TC	NBR	63-90-10MTCN
NTC80781	65	85	10	TC	NBR	65-85-10MTCN
NTC80783	65	80	8	TC	NBR	65-80-8MTCN
NTC80785	65	85	10	TC	NBR	65-85-10MTCN
NTC80787	65	88	12	TC	NBR	65-88-12MTCN
NTC80789	65	90	10	TC	NBR	65-90-10MTCN
NTC80791	65	95	10	TC	NBR	65-95-10MTCN

Old Part No.	Shaft Dia.	Bore Dia.	Seal Width	Seal Type	MTRL	New Part No.
NTC80793	65	100	10	TC	NBR	65-100-10MTCN
NTC80795	65	110	13	TC	NBR	65-110-13MTCN
NTC80797	65	115	12	TC	NBR	65-115-12MTCN
NTC80799	68	85	10	TC	NBR	68-85-10MTCN
NTC80801	68	90	10	TC	NBR	68-90-10MTCN
NTC80803	68	100	12	TC	NBR	68-100-12MTCN
NTC80805	70	80	10	TC	NBR	70-80-10MTCN
NTC80807	70	85	8	TC	NBR	70-85-8MTCN
NTC80809	70	87	10	TC	NBR	70-87-10MTCN
NTC80811	70	88	12	TC	NBR	70-88-12MTCN
NTC80813	70	90	10	TC	NBR	70-90-10MTCN
NTC80815	70	92	10	TC	NBR	70-92-10MTCN
NTC80817	70	95	10	TC	NBR	70-95-10MTCN
NTC80819	70	100	10	TC	NBR	70-100-10MTCN
NTC80821	70	100	13	TC	NBR	70-100-13MTCN
NTC80823	70	110	8	TC	NBR	70-110-8MTCN
NTC80825	70	112	13	TC	NBR	70-112-13MTCN
NTC80827	72	96	9	TC	NBR	72-96-9MTCN
NTC80829	72	100	10	TC	NBR	72-100-10MTCN
NTC80831	72	105	13	TC	NBR	72-105-13MTCN
NTC80833	75	90	10	TC	NBR	75-90-10MTCN
NTC80835	75	95	10	TC	NBR	75-95-10MTCN
NTC80837	75	100	10	TC	NBR	75-100-10MTCN
NTC80839	75	100	12	TC	NBR	75-100-12MTCN
NTC80841	75	105	12	TC	NBR	75-105-12MTCN
NTC80843	75	110	13	TC	NBR	75-110-13MTCN
NTC80845	75	115	10	TC	NBR	75-115-10MTCN
NTC80847	76	102	13	TC	NBR	76-102-13MTCN
NTC80849	78	100	10	TC	NBR	78-100-10MTCN
NTC80851	80	95	8	TC	NBR	80-95-8MTCN
NTC80853	80	100	8	TC	NBR	80-100-8MTCN
NTC80855	80	105	10	TC	NBR	80-105-10MTCN
NTC80857	80	110	10	TC	NBR	80-110-10MTCN
NTC80859	80	115	13	TC	NBR	80-115-13MTCN
NTC80861	82	105	12	TC	NBR	82-105-12MTCN
NTC80863	84	110	16	TC	NBR	84-110-16MTCN
NTC80865	85	105	12	TC	NBR	85-105-12MTCN
NTC80867	85	110	10	TC	NBR	85-110-10MTCN
NTC80869	85	120	12	TC	NBR	85-120-12MTCN
NTC80871	85	125	12	TC	NBR	85-125-12MTCN
NTC80873	85	130	12	TC	NBR	85-130-12MTCN
NTC80875	85	140	12	TC	NBR	85-140-12MTCN
NTC80877	90	105	10	TC	NBR	90-105-10MTCN
NTC80879	90	110	8	TC	NBR	90-110-8MTCN
NTC80881	90	115	12	TC	NBR	90-115-12MTCN
NTC80883	90	118	12	TC	NBR	90-118-12MTCN
NTC80885	90	120	12	TC	NBR	90-120-12MTCN
NTC80887	90	125	13	TC	NBR	90-125-13MTCN
NTC80889	95	115	12	TC	NBR	95-115-12MTCN
NTC80891	95	120	12	TC	NBR	95-120-12MTCN
NTC80893	95	125	12	TC	NBR	95-125-12MTCN
NTC80895	95	130	12	TC	NBR	95-130-12MTCN
NTC80897	95	135	13	TC	NBR	95-135-13MTCN
NTC80899	95	145	13	TC	NBR	95-145-13MTCN
NTC80901	100	120	12	TC	NBR	100-120-12MTCN
NTC80903	100	125	12	TC	NBR	100-125-12MTCN
NTC80905	100	130	13	TC	NBR	100-130-13MTCN
NTC80907	100	140	13	TC	NBR	100-140-13MTCN

03/03/06



ProTech™ Bearing Isolator Applications

Catalog EPS 5350/USA

Competitor Part No.	Location	ProTech Part No.
Goulds Pump		
3138 S	INBOARD	LSE-2125-3000-1-1
3139 S	INBOARD	LSE-2125-3000-1-1
3145 S	OUTBOARD	LSE-2375-3250-1-1
3171 L	OUTBOARD	LPE-1875-5000-B67
3171 M	OUTBOARD	LSE-1375-3625-B66
3171 S	OUTBOARD	LPE-0875-2750-B79
3175 L	OUTBOARD INBOARD	LSE-4125-5250-5-1 LSE-4313-5500-5-1
3175 M	OUTBOARD INBOARD	LSE-3125-4125-1-1 LSE-3313-4125-1-1
3175 S	OUTBOARD INBOARD	LSE-2375-3250-1-1 LSE-2500-3250-1-1
3175 XL	OUTBOARD INBOARD	LPE-4313-5500-C05 LSE-5000-6250-5-1
3180 L	OUTBOARD/INBOARD	LSM-0700-0950-1-1
3180 M	OUTBOARD	LSM-0480-0700-1-1
3180 S	OUTBOARD INBOARD	LSM-0480-0700-1-1 LSM-0550-0800-1-1
3180 XL	OUTBOARD	LSM-0850-1100-1-1
3185 L	INBOARD	LSM-0700-0950-1-1
3185 M	OUTBOARD	LSM-0600-0850-1-1
3185 S	OUTBOARD INBOARD	LSM-0480-0700-1-1 LSM-0550-0800-1-1
3185 XL	OUTBOARD	LSM-0850-1100-1-1
3196 LT/LTC/LTX	OUTBOARD INBOARD	LSE-1875-2750-1-1 LSE-2125-2875-1-1
3196 MT/MTX	OUTBOARD INBOARD	LSE-1125-2000-1-1 LSE-1750-2875-1-1
3196 ST/STX	OUTBOARD INBOARD	LPE-0875-1250-B48 LPE-1375-2835-B47
3196 XLT/XTX	OUTBOARD INBOARD	LSE-2375-3250-1-1 LSE-2500-3250-1-1
3316 L	INBOARD OUTBOARD	LSE-1937-3000-1-1 LSE-2062-3000-1-1
3316 M	OUTBOARD INBOARD	LSE-1375-2125-1-1 LSE-1437-2250-1-1
3316 S	INBOARD OUTBOARD	LPE-1063-1643-F08 LSE-0937-1500-1-1
3410 L	OUTBOARD INBOARD	LPE-2187-3000-1-1 LPE-2125-3000-1-1
3410 M	OUTBOARD INBOARD	LPE-1500-2125-Q57 LPE-1375-2125-Q58
3410 S	OUTBOARD INBOARD	LPE-1500-2125-Q57 LPE-1375-2125-Q58
3996 M	OUTBOARD INBOARD	LPE-1750-2875-B49 LPE-1250-2000-B50
3996 S	OUTBOARD INBOARD INBOARD	LPE-0875-1250-B48 LPE-1375-1875-C56 LPE-1375-2125-B63

Competitor Part No.	Location	ProTech Part No.
Durco Pump		
MK II GRP I	OUTBOARD INBOARD	LSE-0875-1625-1-1 LPE-1125-2441-C70
MK II GRP II	OUTBOARD INBOARD	LSE-1125-2000-1-1 LSE-1875-2625-1-1
MK II GRP III	OUTBOARD INBOARD	LSE-2625-3675-1-1 LSE-2625-3625-1-1
MK III GRP I	OUTBOARD INBOARD	LDE-0875-1625-1-1 LDE-1375-2835-1-1
MK III GRP II	OUTBOARD INBOARD	LDE-1125-2000-1-1 LDE-1875-2625-1-1
MK III GRP III	OUTBOARD INBOARD	LSE-2625-3675-1-1 LDE-2625-3675-1-1
ITT-AC Pump		
CSO, F4A1	INBOARD/OUTBOARD	LSE-1000-1750-1-1
CSO, F4B2	INBOARD OUTBOARD	LSE-1750-2375-1-1 LSE-1125-1750-1-1
CSO, F4B3	INBOARD OUTBOARD	LSE-1750-2372-1-1 LSE-1125-1750-1-1
CSO, F4D1	INBOARD OUTBOARD	LPE-2125-2875-F73 LSE-1250-2000-1-1
PWO, F8B1	INBOARD OUTBOARD	LSE-3250-4000-1-1 LSE-2750-3500-1-1
PWO, F8B2	INBOARD OUTBOARD	LSE-3250-4000-1-1 LSE-2750-3500-1-1
PWO, F8B4	INBOARD OUTBOARD	LSE-3250-4000-1-1 LSE-2750-3500-1-1
PWO, F8M1	INBOARD OUTBOARD	LSE-3250-4000-1-1 LSE-2750-3500-1-1
PWO, F9B1	INBOARD OUTBOARD	LSE-3250-4000-1-1 LSE-2750-3500-1-1
PWO, F9M1	INBOARD OUTBOARD	LSE-3250-4000-1-1 LSE-2750-3500-1-1
PWO, F8C1	INBOARD OUTBOARD	LSE-4500-5500-5-1 LSE-3750-4750-1-1
Warren Pump		
8 MARK I	INBOARD OUTBOARD	LSE-2875-4125-1-1 LSE-2000-3125-1-1
11 MARK I	INBOARD OUTBOARD	LSE-4500-5250-5-1 LSE-3500-4375-1-1
11 MARK II	INBOARD OUTBOARD	LSE-5000-6000-5-1 LSE-3500-4375-1-1
125 MARK I	INBOARD OUTBOARD	LPE-5250-6500-5-1 LSE-4000-5375-5-1
125 MARK II	INBOARD OUTBOARD	LSE-5875-7125-5-1 LSE-4000-5375-5-1
138 MARK II	INBOARD OUTBOARD	LSE-6250-7750-H19 LSE-4500-6000-5-1

Note: Call factory for complete pump list. Call factory for electric motor interchanges.

03/03/06



Other Parker EPS Products

Catalog EPS 5350/USA

Parker EPS Division

Parker EPS Division designs and manufactures engineered elastomeric, polymeric and plastic seals and sealing systems for dynamic applications. EPS Division has a worldwide sealing network consisting of manufacturing locations in Utah, Texas, New York, Illinois and Baja, Mexico; and more than 200 distributor and service center locations in nine countries.

Catalog Services

EPS Division's catalogs and technical bulletins are available through Parker's Catalog Services. To order catalogs and have them shipped directly, call 1-800-C-PARKER, or send your requests via e-mail to: catalogs@parker.com.

Technical Support

Parker product engineers are available to address temperature, pressure, gland design, surface finish and all other seal design considerations, and can often optimize an existing design or propose cost-effective alternatives. Our in-house test and R&D laboratories enable us to quickly develop and perform appropriate test protocols for our customers.

See Catalog EPS 5370: Fluid Power Seal Design Guide, for:



Rod Seals

Parker is the premiere manufacturer of quality rod sealing products both in standard inch as well as metric sizes, in a wide range of urethane and traditional elastomer compounds.



Piston Seals

Parker is pleased to provide a diverse offering of piston seal profiles to suit a broad range of applications. Various cap materials extend service to a broad range of application pressures and temperatures.



Rod Wipers & Scrapers

Parker is the leading manufacturer of rod wipers and scrapers in a variety of geometries to suit any rod application. Parker's rod wipers are offered in a wide range of urethanes as well as traditional elastomers in standard inch and metric sizes.



U-Cup Seals

Parker's U-cup seals are compact and versatile. Varying lip design configurations coupled with the broad range of available Parker materials mean versatility in U-cup sealing, both in hydraulic and pneumatic applications.

03/03/06



Finite Element Analysis & Seal Design Optimization

Using sophisticated Finite Element Analysis (FEA) software, Parker engineers can analyze critical design information, such as stress concentration, heat transfer, fluid flow and electromagnetic properties of new and existing seal geometry. This streamlines tooling and production processes, and helps ensure the selection of the right material and geometry for your application. Using FEA technology, our engineers can determine:

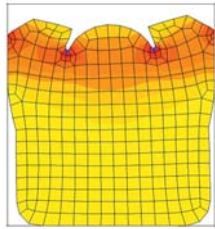

FEA plot of a Parker Seal geometry under compression

- Deformation (deformed shape)
- Volume/void ratios, gland fill %
- Stress distribution
- Load - Deflection
- Stability analysis
- Friction force
- Thermal effects
- Material evaluation
- Seal life prediction



Wear Rings and Bearings

Parker is pleased to offer a complete line of MolyGard™, WearGard™ and PTFE wear rings and bearing products to fit any application. Expertise in both engineered hard plastics and in

PTFE makes Parker the global leader for reciprocating bearing materials. By incorporating premium material blends with precision machining tolerances (down to ± .001"), Parker meets the full spectrum of needs, from heavy duty hydraulic cylinders operating under the highest temperatures and pressures to pneumatic applications requiring low friction, long life and self-lubrication.

See: Catalog EPS 5276



Integrated Piston Assembly

Parker's Integrated Piston combines the piston, bearing and seal into a self-contained package for low, medium and high pressure hydraulic cylinder applications.

See: Catalog EPS 5220



ProTech Bearing Isolators

ProTech bearing isolators are the ultimate in bearing protection with unitized, two-piece, non-contact design. ProTech provides zero lubricant leakage and total exclusion of contaminants.

See: Catalog EPS 5275



PTFE Seals: FlexiSeal®, FlexiLip™, and FlexiCase™

Parker manufactures a wide range of PTFE seals to meet the unique temperature, chemical and low friction requirements of high-performance systems. Products are available in standard inch, metric and custom designs.

See: Catalog EPS 5340

About Parker Hannifin Corporation

Catalog EPS 5350/USA

Parker Hannifin is a leading global motion-control company dedicated to delivering premier customer service. A Fortune 500 corporation listed on the New York Stock Exchange (PH), our components and systems comprise over 1,400 product lines that control motion in some 1,200 industrial and aerospace markets. Parker is the only manufacturer to offer its customers a choice of hydraulic, pneumatic and electromechanical motion-control solutions. Our company has the largest distribution network in its field, with over 7,500 distributors serving more than 400,000 customers worldwide.

The Aerospace Group

is a leader in the development, design, manufacture and servicing of control systems and components for aerospace and related high-technology markets, while achieving growth through premier customer service.



The Climate & Industrial Controls Group

designs, manufactures and markets system-control and fluid-handling components and systems to refrigeration, air-conditioning and industrial customers worldwide.



The Fluid Connectors Group

designs, manufactures and markets rigid and flexible connectors, and associated products used in pneumatic and fluid systems.



The Seal Group

designs, manufactures and distributes industrial and commercial sealing devices and related products by providing superior quality and total customer satisfaction.



The Hydraulics Group

designs, produces and markets a full spectrum of hydraulic components and systems to builders and users of industrial and mobile machinery and equipment.



The Filtration Group

designs, manufactures and markets quality filtration and clarification products, providing customers with the best value, quality, technical support and global availability.



The Automation Group

is a leading supplier of pneumatic and electromechanical components and systems to automation customers worldwide.



The Instrumentation Group

is a global leader in the design, manufacture and distribution of high-quality critical flow components for worldwide process instrumentation, ultra-high-purity, medical and analytical applications.



Parker's Charter

To be a leading worldwide manufacturer of components and systems for the builders and users of durable goods. More specifically, we will design, market and manufacture products controlling motion, flow and pressure. We will achieve profitable growth through premier customer service.

Product Information

North American customers seeking product information, the location of a nearby distributor, or repair services will receive prompt attention by calling Parker Product Information Center at our toll-free number: 1-800-C-PARKER (1-800-272-7537). In Europe, call 00800-C-PARKER-H (00800-2727-5374).

03/03/06



The items described in this document are hereby offered for sale at prices to be established by Parker Hannifin Corporation, its subsidiaries and its authorized distributors. This offer and its acceptance by any customer ("Buyer") shall be governed by all of the following Terms and Conditions. Buyer's order for any item described in this document, when communicated to Parker Hannifin Corporation, its subsidiary or any authorized distributor ("Seller") verbally or in writing, shall constitute acceptance of this offer.

1. Terms and Conditions of Sale: All descriptions, quotations, proposals, offers, acknowledgements, acceptances and sales of Seller's products are subject to and shall be governed exclusively by the terms and conditions stated herein. Buyer's acceptance of any offer to sell is limited to these terms and conditions. Any terms or conditions in addition to, or inconsistent with those stated herein, proposed by Buyer in any acceptance of an offer by Seller, are hereby objected to. No such additional, different or inconsistent terms and conditions shall become part of the contract between Buyer and Seller unless expressly accepted in writing by Seller. Seller's acceptance of any offer to purchase by Buyer is expressly conditional upon Buyer's assent to all the terms and conditions stated herein, including any terms in addition to, or inconsistent with those contained in Buyer's offer. Acceptance of Seller's products shall in all events constitute such assent.

2. Payment: Payment shall be made by Buyer net 30 days from the date of invoice of the items purchased hereunder. Seller reserves the right to charge interest on all past due amounts. Any claims by Buyer for omissions or shortages in a shipment shall be waived unless Seller receives notice thereof within 30 days after Buyer's receipt of the shipment.

3. Delivery: Unless otherwise provided in the face hereof, delivery shall be made F.O.B. Seller's plant. Regardless of the method of delivery, however, risk of loss shall pass to Buyer upon Seller's delivery to a carrier. Any delivery dates shown are approximate only and Seller shall have no liability for any delays in delivery.

4. Warranty: Seller warrants that the items sold hereunder shall be free from defects in material or workmanship at the time of delivery. THIS WARRANTY COMPRISES THE SOLE AND ENTIRE WARRANTY PERTAINING TO ITEMS PROVIDED HEREUNDER. SELLER MAKES NO OTHER WARRANTY, GUARANTEE, OR REPRESENTATION OF ANY KIND WHATSOEVER. ALL OTHER WARRANTIES, INCLUDING, BUT NOT LIMITED TO, MERCHANTABILITY AND FITNESS FOR PURPOSE, WHETHER EXPRESS, IMPLIED OR ARISING BY OPERATION OF LAW, TRADE USAGE, OR COURSE OF DEALING ARE HEREBY DISCLAIMED. NOTWITHSTANDING THE FOREGOING, THERE ARE NO WARRANTIES WHATSOEVER ON ITEMS BUILT OR ACQUIRED WHOLLY OR PARTIALLY, TO BUYER'S DESIGNS OR SPECIFICATIONS.

5. Limitation of Remedy: SELLER'S LIABILITY ARISING FROM OR IN ANY WAY CONNECTED WITH THE ITEMS SOLD OR THIS CONTRACT SHALL BE LIMITED EXCLUSIVELY TO REPAIR OR REPLACEMENT OF THE ITEMS SOLD OR REFUND OF THE PURCHASE PRICE PAID BY BUYER, AT SELLER'S SOLE OPTION. IN NO EVENT SHALL SELLER BE LIABLE FOR ANY INCIDENTAL, CONSEQUENTIAL OR SPECIAL DAMAGES OF ANY KIND OR NATURE WHATSOEVER, INCLUDING, BUT NOT LIMITED TO LOST PROFITS ARISING FROM OR IN ANY WAY CONNECTED WITH THIS AGREEMENT OR ITEMS SOLD HEREUNDER, WHETHER ALLEGED TO ARISE FROM BREACH OF CONTRACT, EXPRESS OR IMPLIED WARRANTY, OR IN TORT, INCLUDING WITHOUT LIMITATION, NEGLIGENCE, FAILURE TO WARN OR STRICT LIABILITY.

6. Changes, Reschedules and Cancellations: Buyer may request to modify the designs or specifications for the items sold hereunder as well as the quantities and delivery dates thereof, or may request to cancel all or part of this order, however, no such requested modification or cancellation shall become part of the contract between Buyer and Seller unless accepted by Seller in a written amendment to this Agreement. Acceptance of any such requested modification or cancellation shall be at Seller's discretion, and shall be upon such terms and conditions as Seller may require.

7. Special Tooling: A tooling charge may be imposed for any special tooling, including without limitation, dies, fixtures, molds and patterns, acquired to manufacture items sold pursuant to this contract. Such special tooling shall be and remain Seller's property notwithstanding payment of any charges by Buyer. In no event will Buyer acquire any interest in apparatus belonging to Seller which is utilized in the manufacture of the items sold hereunder, even if such apparatus has been specially converted or adapted for such manufacture and notwithstanding any charges paid by Buyer. Unless otherwise agreed, Seller shall have the right to alter, discard or otherwise dispose of any special tooling or other property in its sole discretion at any time.

8. Buyer's Property: Any designs, tools, patterns, materials, drawings, confidential information or equipment furnished by Buyer or any other items which become Buyer's property, may be considered obsolete and may be

destroyed by Seller after two (2) consecutive years have elapsed without Buyer placing an order for the items which are manufactured using such property. Seller shall not be responsible for any loss or damage to such property while it is in Seller's possession or control.

9. Taxes: Unless otherwise indicated on the face hereof, all prices and charges are exclusive of excise, sales, use, property, occupational or like taxes which may be imposed by any taxing authority upon the manufacture, sale or delivery of the items sold hereunder. If any such taxes must be paid by Seller or if Seller is liable for the collection of such tax, the amount thereof shall be in addition to the amounts for the items sold. Buyer agrees to pay all such taxes or to reimburse Seller therefor upon receipt of its invoice. If Buyer claims exemption from any sales, use or other tax imposed by any taxing authority, Buyer shall save Seller harmless from and against any such tax, together with any interest or penalties thereon which may be assessed if the items are held to be taxable.

10. Indemnity for Infringement of Intellectual Property Rights: Seller shall have no liability for infringement of any patents, trademarks, copyrights, trade dress, trade secrets or similar rights except as provided in this Part 10. Seller will defend and indemnify Buyer against allegations of infringement of U.S. patents, U.S. trademarks, copyrights, trade dress and trade secrets (hereinafter "Intellectual Property Rights"). Seller will defend at its expense and will pay the cost of any settlement or damages awarded in an action brought against Buyer based on an allegation that an item sold pursuant to this contract infringes the Intellectual Property Rights of a third party. Seller's obligation to defend and indemnify Buyer is contingent on Buyer notifying Seller within ten (10) days after the Buyer becomes aware of such allegations of infringement, and Seller having sole control over the defense of any allegations or actions including all negotiations for settlement or compromise. If an item sold hereunder is subject to a claim that it infringes the Intellectual Property Rights of a third party, Seller may, at its sole expense and option, procure for Buyer the right to continue using said item, place or modify said item so as to make it noninfringing, or offer to accept return of said item and return the purchase price less a reasonable allowance for depreciation. Notwithstanding the foregoing, Seller shall have no liability for claims of infringement based on information provided by Buyer, or directed to items delivered hereunder for which the designs are specified in whole or part by Buyer, or infringements resulting from the modification, combination or use in a system of any item sold hereunder. The foregoing provisions of this Part 10 shall constitute Seller's sole and exclusive liability and Buyer's sole and exclusive remedy for infringement of Intellectual Property Rights. If a claim is based on information provided by Buyer or if the design for an item delivered hereunder is specified in whole or in part by Buyer, Buyer shall defend and indemnify Seller for all costs, expenses or judgements resulting from any claim that such item infringes any patent, trademark, copyright, trade dress, trade secret or any similar right.

11. Force Majeure: Seller does not assume the risk of and shall not be liable for delay or failure to perform any of Seller's obligations by reason of circumstances beyond the reasonable control of Seller (hereinafter "Events of Force Majeure"). Events of Force Majeure shall include without limitation, accidents, acts of God, strikes or labor disputes, acts, laws, rules or regulations of any government or government agency, fires, floods, delays or failures in delivery of carriers or suppliers, shortages of materials and any other cause beyond Seller's control.

12. Any special requirements for items to be provided by Seller hereunder including without limitation; compliance with military specifications, special documentation, or testing requirements, must be communicated to Seller in writing at the time the items are first requested. Any such requests that are communicated to Seller after preparation to manufacture an item has commenced may result in additional charges for rework or remanufacture of the item.

13. Entire Agreement/Governing Law: The terms and conditions set forth herein, together with any amendments, modifications and any different terms or conditions expressly accepted by Seller in writing, shall constitute the entire Agreement concerning the items sold, and there are no oral or other representations or agreements which pertain thereto. This Agreement shall be governed in all respects by the law of the State of Ohio. No actions arising out of the sale of the items sold hereunder or this Agreement may be brought by either more than two (2) years after the cause of action accrues.



**Parker Hannifin Corporation, Seal Group
North America**

Engineered Polymer Systems Division

Salt Lake City Operations and Headquarters
2220 South 3600 West
Salt Lake City, UT 84119 USA
Ph: 801-972-3000
Fax: 801-973-4019

Nacogdoches Operations
403 Industrial Drive
Nacogdoches, TX 75963 USA
Ph: 936-560-8900
Fax: 936-560-8998
Toll Free: 1-800-233-3900

Marion Operations
3967 Buffalo Street
Marion, NY 14505 USA
Ph: 315-926-4211
Fax: 315-926-4498

Chicago Operations
2565 Northwest Parkway
Elgin, IL 60124 USA
Ph: 847-783-4300
Fax: 847-783-4301

Houston Operations
9119 Monroe Road
Houston, TX 77061
Ph: 713-910-7700
Fax: 713-910-6600

Parker Hannifin Corporation
Corporate Office
6035 Parkland Blvd.
Cleveland, OH 44124-4141 USA
Ph: 216-896-3000
Fax: 216-896-4000

1-800-C-PARKER
www.parker.com/eps

Your Authorized Parker Seal Distributor

