

Double Pitch Attachments

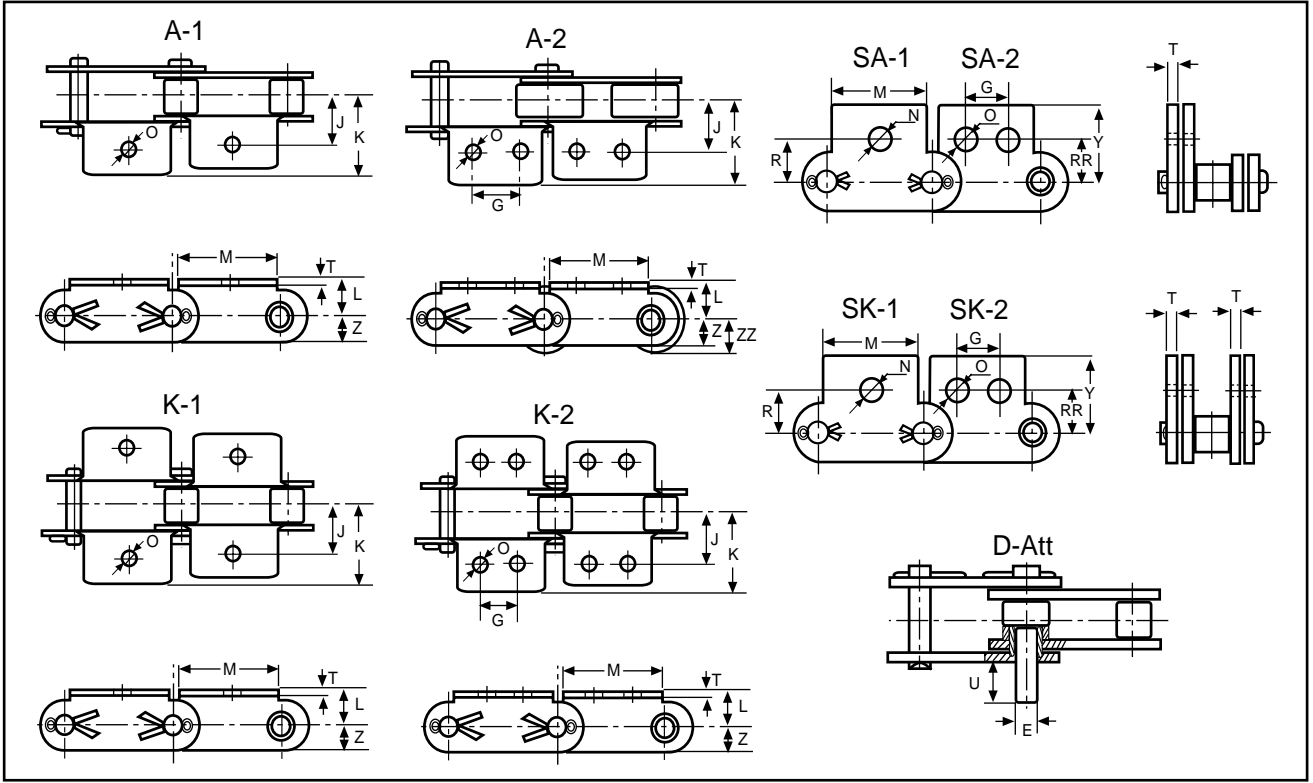

HKK Chain No.	Chain Pitch	J	K	L	M	O	N	G	T	Z	ZZ
HKK C2040 HKK C2042	1	0.500	0.750	0.359	0.750	9/64	13/64	0.375	0.060	0.223	0.312
HKK C2050 HKK C2052	1-1/4	0.625	0.953	0.437	0.937	13/64	17/64	0.468	0.080	0.296	0.375
HKK C2060H HKK C2062H	1-1/2	0.843	1.234	0.578	1.125	13/64	11/32	0.562	0.125	0.335	0.438
HKK C2080H HKK C2082H	2	1.093	1.593	0.750	1.500	17/64	13/32	0.750	0.156	0.445	0.562
HKK C2100H HKK C2102H	2-1/2	1.312	1.968	0.921	1.875	11/32	35/64	0.937	0.187	0.563	0.781
HKK C2120H HKK C2122H	3	1.562	2.437	1.093	2.250	13/32	5/8	1.125	0.218	0.687	0.875
HKK C2160H HKK C2162H	4	2.062	2.984	1.437	3.000	35/64	53/64	1.500	0.281	0.937	1.125

Dimensions in inches & pounds

HKK Chain No.	Chain Pitch	R	RR	Y	E	U	Average Weight Per Attachment (lbs)				
							A att	K att	SA att	SA att	D att
HKK C2040 HKK C2042	1	0.437	0.531	0.781	0.156	0.375	0.007	0.014	0.006	0.012	0.002
HKK C2050 HKK C2052	1-1/4	0.562	0.625	0.968	0.200	0.468	0.014	0.028	0.013	0.026	0.004
HKK C2060H HKK C2062H	1-1/2	0.687	0.750	1.203	0.234	0.562	0.033	0.066	0.032	0.064	0.005
HKK C2080H HKK C2082H	2	0.875	1.000	1.593	0.312	0.750	0.070	0.140	0.070	0.140	0.024
HKK C2100H HKK C2102H	2-1/2	1.125	1.250	1.984	0.375	0.937	0.142	0.284	0.146	0.292	0.030
HKK C2120H HKK C2122H	3	1.312	1.468	2.156	0.437	1.125	0.226	0.452	0.216	0.432	0.050
HKK C2160H HKK C2162H	4	1.750	2.000	3.000	0.562	1.500	0.583	1.166	0.517	1.034	0.100

Dimensions in inches & pounds

**QUICK
REFERENCE
GUIDE**

- Solid Roller ➤ Solid Bushing ➤ Custom Spacing ➤ Stainless Steel
- Nickel Plated ➤ British Standard ➤ Aqua-Series

HKK attachment chains are standard ANSI single and double pitch chains with modified side plates or pins. Attachments may be used for a variety of purposes such as conveying, timing, or alignment. Several types of standard attachments are available from stock while custom attachments can be made to order. HKK carbon steel attachment chains are standard with solid rollers and solid bushings, greatly extending chain life. For corrosive or extreme environments, stainless steel, nickel plated, and Aqua-Series chains are also available. HKK stocks many unique attachments for specialized applications such as the poultry, packaging, and forestry industries.

ATTACHMENT SPACING

When referencing attachment chains, the attachment spacing must be specified. The attachment spacing or centers (space from the center of one attachment to the next) should be referred to in terms of pitches (links). When counting pitches both the outside (pin link) and the inside (roller link) must be counted. Example: Attachments on Every Link (all inside and outside links). Attachments on every second pitch on the pin link (every outside link). Attachments on every second pitch on the roller link (every inside link). Attachment every third pitch (alternating between inside and outside links).

EVERY PITCH

Attachment on both inside and outside links.

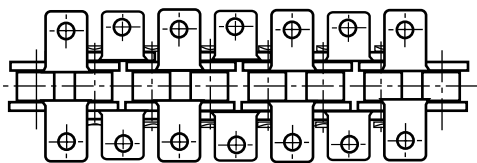

EVERY 3rd PITCH

Attachment alternating on inside and outside.

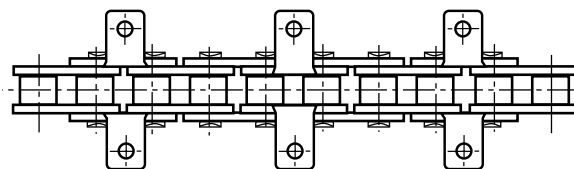

EVERY 2nd Pitch on PIN LINK

Attachment on every outside link.

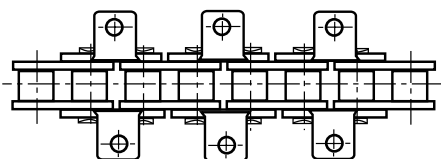

EVERY 4th Pitch on PIN LINK

Attachment on every other outside link.

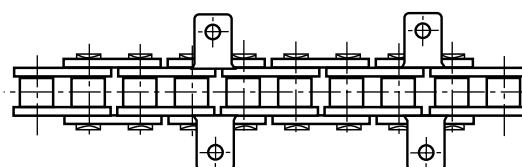

EVERY 2nd Pitch on ROLLER LINK

Attachment on every inside link.

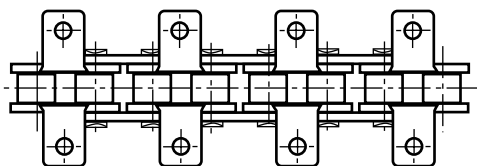

EVERY 4th Pitch on ROLLER LINK

Attachment on every other inside link.

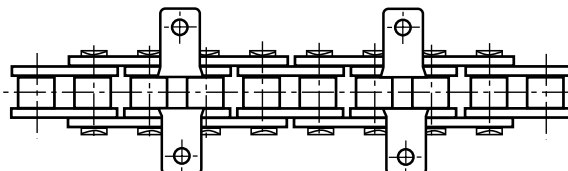

HKK Chain stocks most standard attachment chains in carbon steel and stainless steel. Most custom attachment spacing can be assembled with short delivery times. Single pitch chain with two attachment holes in one attachment is considered wide contour. Many custom attachments are also available or can be made to order, (see page 23.)

HKK (new)	HKK (old)	Dodge, Diamond, Morse	Rex, Link Belt
A-1	A-1	B-1, 1 hole	A-1
K-1	K-1	B-2, 1 hole	K-1
A-2	A-2	B-1, 2 hole	A-2
K-2	K-2	B-2, 2 hole	K-2
SA-1	M-1	S-1, 1 hole	M-35
SK-1	MM-1	S-2, 1 hole	M-1
SA-2	M-2	S-1, 2 hole	M-35-2
SK-2	MM-2	S-2, 2 hole	M-2
D-1	D-1	D-1	D-1
D-3	D-3	D-3	D-3

Single Pitch

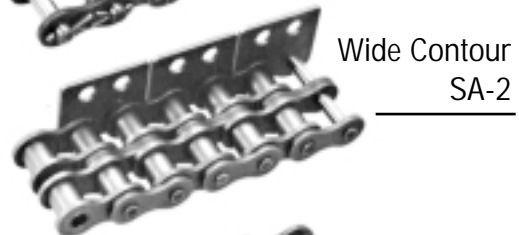

Double Pitch

